

# Manual



## Vector Signal Generator

**R&S<sup>®</sup> SMATE200A**  
1400.7005.02

Printed in Germany



**Dear Customer,**

throughout this manual, the Vector Signal Generator R&S® SMATE200A is abbreviated as R&S SMATE.

The Vector Signal Generator includes software developed by the OpenSSL Project for use in the OpenSSL Toolkit (<http://www.openssl.org/>).

R&S® is a registered trademark of Rohde & Schwarz GmbH & Co. KG  
Trade names are trademarks of the owners.

# Tabbed Divider Overview

Safety Instructions

Certificate of Quality

EU Certificate of Conformity

Support-Center Address

## User documentation for Vector Signal Generator R&S SMATE

### Tabbed Divider

1	Chapter 1:	Putting into Operation
2	Chapter 2:	Getting Started
3	Chapter 3:	Operation
4	Chapter 4:	Instrument Functions
5	Chapter 5:	Remote Control - Basics
6	Chapter 6:	Remote Control - Description of Commands
7	Chapter 7:	-
8	Chapter 8:	Maintenance and Interfaces
9	Chapter 9:	Error Messages
10		Index





**Before putting the product into operation for the first time, make sure to read the following**



# Safety Instructions

Rohde & Schwarz makes every effort to keep the safety standard of its products up to date and to offer its customers the highest possible degree of safety. Our products and the auxiliary equipment required for them are designed and tested in accordance with the relevant safety standards. Compliance with these standards is continuously monitored by our quality assurance system. This product has been designed and tested in accordance with the EC Certificate of Conformity and has left the manufacturer's plant in a condition fully complying with safety standards. To maintain this condition and to ensure safe operation, observe all instructions and warnings provided in this manual. If you have any questions regarding these safety instructions, Rohde & Schwarz will be happy to answer them.

Furthermore, it is your responsibility to use the product in an appropriate manner. This product is designed for use solely in industrial and laboratory environments or in the field and must not be used in any way that may cause personal injury or property damage. You are responsible if the product is used for an intention other than its designated purpose or in disregard of the manufacturer's instructions. The manufacturer shall assume no responsibility for such use of the product.

The product is used for its designated purpose if it is used in accordance with its operating manual and within its performance limits (see data sheet, documentation, the following safety instructions). Using the products requires technical skills and knowledge of English. It is therefore essential that the products be used exclusively by skilled and specialized staff or thoroughly trained personnel with the required skills. If personal safety gear is required for using Rohde & Schwarz products, this will be indicated at the appropriate place in the product documentation.

## Symbols and safety labels

Observe operating instructions	Weight indication for units >18 kg	Danger of electric shock	Warning! Hot surface	PE terminal	Ground	Ground terminal	Attention! Electrostatic sensitive devices

Supply voltage ON/OFF	Standby indication	Direct current (DC)	Alternating current (AC)	Direct/alternating current (DC/AC)	Device fully protected by double/reinforced insulation

## Safety Instructions

Observing the safety instructions will help prevent personal injury or damage of any kind caused by dangerous situations. Therefore, carefully read through and adhere to the following safety instructions before putting the product into operation. It is also absolutely essential to observe the additional safety instructions on personal safety that appear in other parts of the documentation. In these safety instructions, the word "product" refers to all merchandise sold and distributed by Rohde & Schwarz, including instruments, systems and all accessories.

### Tags and their meaning

DANGER	This tag indicates a safety hazard with a high potential of risk for the user that can result in death or serious injuries.
WARNING	This tag indicates a safety hazard with a medium potential of risk for the user that can result in death or serious injuries.
CAUTION	This tag indicates a safety hazard with a low potential of risk for the user that can result in slight or minor injuries.
ATTENTION	This tag indicates the possibility of incorrect use that can cause damage to the product.
NOTE	This tag indicates a situation where the user should pay special attention to operating the product but which does not lead to damage.

These tags are in accordance with the standard definition for civil applications in the European Economic Area. Definitions that deviate from the standard definition may also exist. It is therefore essential to make sure that the tags described here are always used only in connection with the associated documentation and the associated product. The use of tags in connection with unassociated products or unassociated documentation can result in misinterpretations and thus contribute to personal injury or material damage.

### Basic safety instructions

1. The product may be operated only under the operating conditions and in the positions specified by the manufacturer. Its ventilation must not be obstructed during operation. Unless otherwise specified, the following requirements apply to Rohde & Schwarz products:  
prescribed operating position is always with the housing floor facing down, IP protection 2X, pollution severity 2, overvoltage category 2, use only in enclosed spaces, max. operation altitude max. 2000 m. Unless specified otherwise in the data sheet, a tolerance of  $\pm 10\%$  shall apply to the nominal voltage and of  $\pm 5\%$  to the nominal frequency.
2. Applicable local or national safety regulations and rules for the prevention of accidents must be observed in all work performed. The product may be opened only by authorized, specially trained personnel. Prior to performing any work on the product or opening the product, the product must be disconnected from the supply network. Any adjustments, replacements of parts, maintenance or repair must be carried out only by technical personnel authorized by Rohde & Schwarz. Only original parts may be used for replacing parts relevant to safety (e.g. power switches, power transformers, fuses). A safety test must always be performed after parts relevant to safety have been replaced (visual inspection, PE conductor test, insulation resistance measurement, leakage current measurement, functional test).
3. As with all industrially manufactured goods, the use of substances that induce an allergic reaction (allergens, e.g. nickel) such as aluminum cannot be generally excluded. If you develop an allergic reaction (such as a skin rash, frequent sneezing, red eyes or respiratory difficulties), consult a physician immediately to determine the cause.

## Safety Instructions

4. If products/components are mechanically and/or thermally processed in a manner that goes beyond their intended use, hazardous substances (heavy-metal dust such as lead, beryllium, nickel) may be released. For this reason, the product may only be disassembled, e.g. for disposal purposes, by specially trained personnel. Improper disassembly may be hazardous to your health. National waste disposal regulations must be observed.
5. If handling the product yields hazardous substances or fuels that must be disposed of in a special way, e.g. coolants or engine oils that must be replenished regularly, the safety instructions of the manufacturer of the hazardous substances or fuels and the applicable regional waste disposal regulations must be observed. Also observe the relevant safety instructions in the product documentation.
6. Depending on the function, certain products such as RF radio equipment can produce an elevated level of electromagnetic radiation. Considering that unborn life requires increased protection, pregnant women should be protected by appropriate measures. Persons with pacemakers may also be endangered by electromagnetic radiation. The employer is required to assess workplaces where there is a special risk of exposure to radiation and, if necessary, take measures to avert the danger.
7. Operating the products requires special training and intense concentration. Make certain that persons who use the products are physically, mentally and emotionally fit enough to handle operating the products; otherwise injuries or material damage may occur. It is the responsibility of the employer to select suitable personnel for operating the products.
8. Prior to switching on the product, it must be ensured that the nominal voltage setting on the product matches the nominal voltage of the AC supply network. If a different voltage is to be set, the power fuse of the product may have to be changed accordingly.
9. In the case of products of safety class I with movable power cord and connector, operation is permitted only on sockets with earthing contact and protective earth connection.
10. Intentionally breaking the protective earth connection either in the feed line or in the product itself is not permitted. Doing so can result in the danger of an electric shock from the product. If extension cords or connector strips are implemented, they must be checked on a regular basis to ensure that they are safe to use.
11. If the product has no power switch for disconnection from the AC supply, the plug of the connecting cable is regarded as the disconnecting device. In such cases, it must be ensured that the power plug is easily reachable and accessible at all times (length of connecting cable approx. 2 m). Functional or electronic switches are not suitable for providing disconnection from the AC supply. If products without power switches are integrated in racks or systems, a disconnecting device must be provided at the system level.
12. Never use the product if the power cable is damaged. By taking appropriate safety measures and carefully laying the power cable, ensure that the cable cannot be damaged and that no one can be hurt by e.g. tripping over the cable or suffering an electric shock.
13. The product may be operated only from TN/TT supply networks fused with max. 16 A.
14. Do not insert the plug into sockets that are dusty or dirty. Insert the plug firmly and all the way into the socket. Otherwise this can result in sparks, fire and/or injuries.
15. Do not overload any sockets, extension cords or connector strips; doing so can cause fire or electric shocks.
16. For measurements in circuits with voltages  $V_{rms} > 30 V$ , suitable measures (e.g. appropriate measuring equipment, fusing, current limiting, electrical separation, insulation) should be taken to avoid any hazards.
17. Ensure that the connections with information technology equipment comply with IEC 950/EN 60950.
18. Never remove the cover or part of the housing while you are operating the product. This will expose circuits and components and can lead to injuries, fire or damage to the product.

## Safety Instructions

19. If a product is to be permanently installed, the connection between the PE terminal on site and the product's PE conductor must be made first before any other connection is made. The product may be installed and connected only by a skilled electrician.
20. For permanently installed equipment without built-in fuses, circuit breakers or similar protective devices, the supply circuit must be fused in such a way that suitable protection is provided for users and products.
21. Do not insert any objects into the openings in the housing that are not designed for this purpose. Never pour any liquids onto or into the housing. This can cause short circuits inside the product and/or electric shocks, fire or injuries.
22. Use suitable overvoltage protection to ensure that no overvoltage (such as that caused by a thunderstorm) can reach the product. Otherwise the operating personnel will be endangered by electric shocks.
23. Rohde & Schwarz products are not protected against penetration of water, unless otherwise specified (see also safety instruction 1.). If this is not taken into account, there exists the danger of electric shock or damage to the product, which can also lead to personal injury.
24. Never use the product under conditions in which condensation has formed or can form in or on the product, e.g. if the product was moved from a cold to a warm environment.
25. Do not close any slots or openings on the product, since they are necessary for ventilation and prevent the product from overheating. Do not place the product on soft surfaces such as sofas or rugs or inside a closed housing, unless this is well ventilated.
26. Do not place the product on heat-generating devices such as radiators or fan heaters. The temperature of the environment must not exceed the maximum temperature specified in the data sheet.
27. Batteries and storage batteries must not be exposed to high temperatures or fire. Keep batteries and storage batteries away from children. If batteries or storage batteries are improperly replaced, this can cause an explosion (warning: lithium cells). Replace the battery or storage battery only with the matching Rohde & Schwarz type (see spare parts list). Batteries and storage batteries are hazardous waste. Dispose of them only in specially marked containers. Observe local regulations regarding waste disposal. Do not short-circuit batteries or storage batteries.
28. Please be aware that in the event of a fire, toxic substances (gases, liquids etc.) that may be hazardous to your health may escape from the product.
29. Please be aware of the weight of the product. Be careful when moving it; otherwise you may injure your back or other parts of your body.
30. Do not place the product on surfaces, vehicles, cabinets or tables that for reasons of weight or stability are unsuitable for this purpose. Always follow the manufacturer's installation instructions when installing the product and fastening it to objects or structures (e.g. walls and shelves).
31. Handles on the products are designed exclusively for personnel to hold or carry the product. It is therefore not permissible to use handles for fastening the product to or on means of transport such as cranes, fork lifts, wagons, etc. The user is responsible for securely fastening the products to or on the means of transport and for observing the safety regulations of the manufacturer of the means of transport. Noncompliance can result in personal injury or material damage.
32. If you use the product in a vehicle, it is the sole responsibility of the driver to drive the vehicle safely. Adequately secure the product in the vehicle to prevent injuries or other damage in the event of an accident. Never use the product in a moving vehicle if doing so could distract the driver of the vehicle. The driver is always responsible for the safety of the vehicle; the manufacturer assumes no responsibility for accidents or collisions.
33. If a laser product (e.g. a CD/DVD drive) is integrated in a Rohde & Schwarz product, do not use any other settings or functions than those described in the documentation. Otherwise this may be hazardous to your health, since the laser beam can cause irreversible damage to your eyes. Never try to take such products apart, and never look into the laser beam.





**Por favor lea imprescindiblemente antes de la primera puesta en funcionamiento las siguientes informaciones de seguridad**



## Informaciones de seguridad

Es el principio de Rohde & Schwarz de tener a sus productos siempre al día con los estándares de seguridad y de ofrecer a sus clientes el máximo grado de seguridad. Nuestros productos y todos los equipos adicionales son siempre fabricados y examinados según las normas de seguridad vigentes. Nuestra sección de gestión de la seguridad de calidad controla constantemente que sean cumplidas estas normas. Este producto ha sido fabricado y examinado según el comprobante de conformidad adjunto según las normas de la CE y ha salido de nuestra planta en estado impecable según los estándares técnicos de seguridad. Para poder preservar este estado y garantizar un funcionamiento libre de peligros, deberá el usuario atenerse a todas las informaciones, informaciones de seguridad y notas de alerta. Rohde&Schwarz está siempre a su disposición en caso de que tengan preguntas referentes a estas informaciones de seguridad.

Además queda en la responsabilidad del usuario utilizar el producto en la forma debida. Este producto solamente fue elaborado para ser utilizado en la industria y el laboratorio o para fines de campo y de ninguna manera deberá ser utilizado de modo que alguna persona/cosa pueda ser dañada. El uso del producto fuera de sus fines definidos o despreciando las informaciones de seguridad del fabricante queda en la responsabilidad del usuario. El fabricante no se hace en ninguna forma responsable de consecuencias a causa del maluso del producto.

Se parte del uso correcto del producto para los fines definidos si el producto es utilizado dentro de las instrucciones del correspondiente manual del uso y dentro del margen de rendimiento definido (ver hoja de datos, documentación, informaciones de seguridad que siguen). El uso de los productos hace necesarios conocimientos profundos y el conocimiento del idioma inglés. Por eso se deberá tener en cuenta de exclusivamente autorizar para el uso de los productos a personas peritas o debidamente minuciosamente instruidas con los conocimientos citados. Si fuera necesaria indumentaria de seguridad para el uso de productos de R&S, encontrará la información debida en la documentación del producto en el capítulo correspondiente.

### Símbolos y definiciones de seguridad

Ver manual de instrucciones del uso	Informaciones para maquinaria con un peso de > 18kg	Peligro de golpe de corriente	¡Advertencia! Superficie caliente	Conexión a conductor protector	Conexión a tierra	Conexión a masa conductora	¡Cuidado! Elementos de construcción con peligro de carga electrostática

potencia EN MARCHA/PARADA	Indicación Stand-by	Corriente continua DC	Corriente alterna AC	Corriente continua/alterna DC/AC	El aparato está protegido en su totalidad por un aislamiento de doble refuerzo

## Informaciones de seguridad

Tener en cuenta las informaciones de seguridad sirve para tratar de evitar daños y peligros de toda clase. Es necesario de que se lean las siguientes informaciones de seguridad concienzudamente y se tengan en cuenta debidamente antes de la puesta en funcionamiento del producto. También deberán ser tenidas en cuenta las informaciones para la protección de personas que encontrarán en otro capítulo de esta documentación y que también son obligatorias de seguir. En las informaciones de seguridad actuales hemos juntado todos los objetos vendidos por Rohde&Schwarz bajo la denominación de „producto“, entre ellos también aparatos, instalaciones así como toda clase de accesorios.

### Palabras de señal y su significado

PELIGRO	Indica un punto de peligro con gran potencial de riesgo para el usuario. Punto de peligro que puede llevar hasta la muerte o graves heridas.
ADVERTENCIA	Indica un punto de peligro con un potencial de riesgo mediano para el usuario. Punto de peligro que puede llevar hasta la muerte o graves heridas .
ATENCIÓN	Indica un punto de peligro con un potencial de riesgo pequeño para el usuario. Punto de peligro que puede llevar hasta heridas leves o pequeñas
CUIDADO	Indica la posibilidad de utilizar mal el producto y a consecuencia dañarlo.
INFORMACIÓN	Indica una situación en la que deberían seguirse las instrucciones en el uso del producto, pero que no consecuentemente deben de llevar a un daño del mismo.

Las palabras de señal corresponden a la definición habitual para aplicaciones civiles en el ámbito de la comunidad económica europea. Pueden existir definiciones diferentes a esta definición. Por eso se debiera tener en cuenta que las palabras de señal aquí descritas sean utilizadas siempre solamente en combinación con la correspondiente documentación y solamente en combinación con el producto correspondiente. La utilización de las palabras de señal en combinación con productos o documentaciones que no les correspondan puede llevar a malinterpretaciones y tener por consecuencia daños en personas u objetos.

### Informaciones de seguridad elementales

1. El producto solamente debe ser utilizado según lo indicado por el fabricante referente a la situación y posición de funcionamiento sin que se obstruya la ventilación. Si no se convino de otra manera, es para los productos R&S válido lo que sigue: como posición de funcionamiento se define principalmente la posición con el suelo de la caja para abajo , modo de protección IP 2X, grado de suciedad 2, categoría de sobrecarga eléctrica 2, utilizar solamente en estancias interiores, utilización hasta 2000 m sobre el nivel del mar.  
A menos que se especifique otra cosa en la hoja de datos, se aplicará una tolerancia de  $\pm 10\%$  sobre el voltaje nominal y de  $\pm 5\%$  sobre la frecuencia nominal.
2. En todos los trabajos deberán ser tenidas en cuenta las normas locales de seguridad de trabajo y de prevención de accidentes. El producto solamente debe de ser abierto por personal périto autorizado. Antes de efectuar trabajos en el producto o abrirlo deberá este ser desconectado de la corriente. El ajuste, el cambio de partes, la manutención y la reparación deberán ser solamente efectuadas por electricistas autorizados por R&S. Si se reponen partes con importancia para los aspectos de seguridad (por ejemplo el enchufe, los transformadores o los fusibles), solamente podrán ser sustituidos por partes originales. Despues de cada recambio de partes elementales para la seguridad deberá ser efectuado un control de

## Informaciones de seguridad

- seguridad (control a primera vista, control de conductor protector, medición de resistencia de aislamiento, medición de medición de la corriente conductora, control de funcionamiento).
3. Como en todo producto de fabricación industrial no puede ser excluido en general de que se produzcan al usarlo elementos que puedan generar alergias, los llamados elementos alergénicos (por ejemplo el níquel). Si se produjeran en el trato con productos R&S reacciones alérgicas, como por ejemplo urticaria, estornudos frecuentes, irritación de la conjuntiva o dificultades al respirar, se deberá consultar inmediatamente a un médico para averiguar los motivos de estas reacciones.
  4. Si productos / elementos de construcción son tratados fuera del funcionamiento definido de forma mecánica o térmica, pueden generarse elementos peligrosos (polvos de sustancia de metales pesados como por ejemplo plomo, berilio, níquel). La partición elemental del producto, como por ejemplo sucede en el tratamiento de materias residuales, debe de ser efectuada solamente por personal especializado para estos tratamientos. La partición elemental efectuada inadecuadamente puede generar daños para la salud. Se deben tener en cuenta las directivas nacionales referentes al tratamiento de materias residuales.
  5. En el caso de que se produjeran agentes de peligro o combustibles en la aplicación del producto que debieran de ser transferidos a un tratamiento de materias residuales, como por ejemplo agentes refrigerantes que deben ser repuestos en periodos definidos, o aceites para motores, deberán ser tenidas en cuenta las prescripciones de seguridad del fabricante de estos agentes de peligro o combustibles y las regulaciones regionales para el tratamiento de materias residuales. Cuiden también de tener en cuenta en caso dado las prescripciones de seguridad especiales en la descripción del producto.
  6. Ciertos productos, como por ejemplo las instalaciones de radiación HF, pueden a causa de su función natural, emitir una radiación electromagnética aumentada. En vista a la protección de la vida en desarrollo deberían ser protegidas personas embarazadas debidamente. También las personas con un bypass pueden correr peligro a causa de la radiación electromagnética. El empresario está comprometido a valorar y señalar áreas de trabajo en las que se corra un riesgo de exposición a radiaciones aumentadas de riesgo aumentado para evitar riesgos.
  7. La utilización de los productos requiere instrucciones especiales y una alta concentración en el manejo. Debe de ponerse por seguro de que las personas que manejen los productos estén a la altura de los requerimientos necesarios referente a sus aptitudes físicas, psíquicas y emocionales, ya que de otra manera no se pueden excluir lesiones o daños de objetos. El empresario lleva la responsabilidad de seleccionar el personal usuario apto para el manejo de los productos.
  8. Antes de la puesta en marcha del producto se deberá tener por seguro de que la tensión preseleccionada en el producto equivalga a la del la red de distribución. Si es necesario cambiar la preselección de la tensión también se deberán en caso dabo cambiar los fusibles correspondientes del producto.
  9. Productos de la clase de seguridad I con alimentación móvil y enchufe individual de producto solamente deberán ser conectados para el funcionamiento a tomas de corriente de contacto de seguridad y con conductor protector conectado.
  10. Queda prohibida toda clase de interrupción intencionada del conductor protector, tanto en la toma de corriente como en el mismo producto ya que puede tener como consecuencia el peligro de golpe de corriente por el producto. Si se utilizaran cables o enchufes de extensión se deberá poner al seguro, que es controlado su estado técnico de seguridad.
  11. Si el producto no está equipado con un interruptor para desconectarlo de la red, se deberá considerar el enchufe del cable de distribución como interruptor. En estos casos deberá asegurar de que el enchufe sea de fácil acceso y nabejo (medida del cable de distribución aproximadamente 2 m). Los interruptores de función o electrónicos no son aptos para el corte de la red eléctrica. Si los productos sin interruptor están integrados en construcciones o instalaciones, se deberá instalar el interruptor al nivel de la instalación.

## Informaciones de seguridad

12. No utilice nunca el producto si está dañado el cable eléctrico. Asegure a través de las medidas de protección y de instalación adecuadas de que el cable de eléctrico no pueda ser dañado o de que nadie pueda ser dañado por él, por ejemplo al tropezar o por un golpe de corriente.
13. Solamente está permitido el funcionamiento en redes de distribución TN/TT aseguradas con fusibles de como máximo 16 A.
14. Nunca conecte el enchufe en tomas de corriente sucias o llenas de polvo. Introduzca el enchufe por completo y fuertemente en la toma de corriente. Si no tiene en consideración estas indicaciones se arriesga a que se originen chispas, fuego y/o heridas.
15. No sobrecargue las tomas de corriente, los cables de extensión o los enchufes de extensión ya que esto pudiera causar fuego o golpes de corriente.
16. En las mediciones en circuitos de corriente con una tensión de entrada de  $U_{eff} > 30 \text{ V}$  se deberá tomar las precauciones debidas para impedir cualquier peligro (por ejemplo medios de medición adecuados, seguros, limitación de tensión, corte protector, aislamiento etc.).
17. En caso de conexión con aparatos de la técnica informática se deberá tener en cuenta que estos cumplan los requisitos de la EC950/EN60950.
18. Nunca abra la tapa o parte de ella si el producto está en funcionamiento. Esto pone a descubierto los cables y componentes eléctricos y puede causar heridas, fuego o daños en el producto.
19. Si un producto es instalado fijamente en un lugar, se deberá primero conectar el conductor protector fijo con el conductor protector del aparato antes de hacer cualquier otra conexión. La instalación y la conexión deberán ser efectuadas por un electricista especializado.
20. En caso de que los productos que son instalados fijamente en un lugar sean sin protector implementado, autointerruptor o similares objetos de protección, deberá la toma de corriente estar protegida de manera que los productos o los usuarios estén suficientemente protegidos.
21. Por favor, no introduzca ningún objeto que no esté destinado a ello en los orificios de la caja del aparato. No vierta nunca ninguna clase de líquidos sobre o en la caja. Esto puede producir corto circuitos en el producto y/o puede causar golpes de corriente, fuego o heridas.
22. Asegúrese con la protección adecuada de que no pueda originarse en el producto una sobrecarga por ejemplo a causa de una tormenta. Si no se verá el personal que lo utilice expuesto al peligro de un golpe de corriente.
23. Los productos R&S no están protegidos contra el agua si no es que exista otra indicación, ver también punto 1. Si no se tiene en cuenta esto se arriesga el peligro de golpe de corriente o de daños en el producto lo cual también puede llevar al peligro de personas.
24. No utilice el producto bajo condiciones en las que pueda producirse y se hayan producido líquidos de condensación en o dentro del producto como por ejemplo cuando se desplaza el producto de un lugar frío a un lugar caliente.
25. Por favor no cierre ninguna ranura u orificio del producto, ya que estas son necesarias para la ventilación e impiden que el producto se caliente demasiado. No pongan el producto encima de materiales blandos como por ejemplo sofás o alfombras o dentro de una caja cerrada, si esta no está suficientemente ventilada.
26. No ponga el producto sobre aparatos que produzcan calor, como por ejemplo radiadores o calentadores. La temperatura ambiental no debe superar la temperatura máxima especificada en la hoja de datos.

## Informaciones de seguridad

27. Baterías y acumuladores no deben de ser expuestos a temperaturas altas o al fuego. Guardar baterías y acumuladores fuera del alcance de los niños. Si las baterías o los acumuladores no son cambiados con la debida atención existirá peligro de explosión (atención celulas de Litio). Cambiar las baterías o los acumuladores solamente por los del tipo R&S correspondiente (ver lista de piezas de recambio). Baterías y acumuladores son deshechos problemáticos. Por favor tirenlos en los recipientes especiales para este fin. Por favor tengan en cuenta las prescripciones nacionales de cada país referente al tratamiento de deshechos. Nunca sometan las baterías o acumuladores a un corto circuito.
28. Tengan en consideración de que en caso de un incendio pueden escaparse gases tóxicos del producto, que pueden causar daños a la salud.
29. Por favor tengan en cuenta que en caso de un incendio pueden desprenderse del producto agentes venenosos (gases, líquidos etc.) que pueden generar daños a la salud.
30. No sitúe el producto encima de superficies, vehículos, estantes o mesas, que por sus características de peso o de estabilidad no sean aptas para él. Siga siempre las instrucciones de instalación del fabricante cuando instale y asegure el producto en objetos o estructuras (por ejemplo paredes y estantes).
31. Las asas instaladas en los productos sirven solamente de ayuda para el manejo que solamente está previsto para personas. Por eso no está permitido utilizar las asas para la sujecion en o sobre medios de transporte como por ejemplo grúas, carretillas elevadoras de horquilla, carros etc. El usuario es responsable de que los productos sean sujetados de forma segura a los medios de transporte y de que las prescripciones de seguridad del fabricante de los medios de transporte sean tenidas en cuenta. En caso de que no se tengan en cuenta pueden causarse daños en personas y objetos.
32. Si llega a utilizar el producto dentro de un vehículo, queda en la responsabilidad absoluta del conductor que conducir el vehículo de manera segura. Asegure el producto dentro del vehículo debidamente para evitar en caso de un accidente las lesiones u otra clase de daños. No utilice nunca el producto dentro de un vehículo en movimiento si esto pudiera distraer al conductor. Siempre queda en la responsabilidad absoluta del conductor la seguridad del vehículo y el fabricante no asumirá ninguna clase de responsabilidad por accidentes o colisiones.
33. Dado el caso de que esté integrado un producto de laser en un producto R&S (por ejemplo CD/DVD-ROM) no utilice otras instalaciones o funciones que las descritas en la documentación. De otra manera pondrá en peligro su salud, ya que el rayo laser puede dañar irreversiblemente sus ojos. Nunca trate de descomponer estos productos. Nunca mire dentro del rayo laser.





Certificate No.: 2005-04

This is to certify that:

Equipment type	Stock No.	Designation
SMATE200A	1400.7005.02	Vector Signal Generator
SMATE-B10	1401.2707.02	Baseband Generator
SMATE-B11	1401.2807.02	Baseband Generator
SMATE-B13	1401.2907.02	Baseband Main Modul
SMATE-B16	1401.2407.02	Differential I/Q Output
SMATE-B31	1401.1800.02	High Power Output for 1st RF Path
SMATE-B36	1401.2107.02	High Power Output for 2nd RF Path
SMATE-B103	1401.1000.02	Freq. Range to 3 GHz for 1st RF Path
SMATE-B106	1401.1200.02	Freq. Range to 6 GHz for 1st RF Path
SMATE-B203	1401.1400.02	Freq. Range to 3 GHz for 2nd RF Path
SMATE-B206	1401.1600.02	Freq.-bereich bis 6 GHz für 2. HF-Pfad

complies with the provisions of the Directive of the Council of the European Union on the approximation of the laws of the Member States

- relating to electrical equipment for use within defined voltage limits  
(73/23/EEC revised by 93/68/EEC)
- relating to electromagnetic compatibility  
(89/336/EEC revised by 91/263/EEC, 92/31/EEC, 93/68/EEC)

Conformity is proven by compliance with the following standards:

EN61010-1 : 2001-12  
EN55011 : 1998 + A1 : 1999, Klasse B  
EN61326 : 1997 + A1 : 1998 + A2 : 2001

For the assessment of electromagnetic compatibility, the limits of radio interference for Class B equipment as well as the immunity to interference for operation in industry have been used as a basis.

Affixing the EC conformity mark as from 2005

Munich, 2005-02-03

**ROHDE & SCHWARZ GmbH & Co. KG**  
**Mühldorfstr. 15, D-81671 München**  
Central Quality Management MF-QZ / Radde







### Qualitätszertifikat

Sehr geehrter Kunde,

Sie haben sich für den Kauf eines Rohde & Schwarz-Produktes entschieden. Hiermit erhalten Sie ein nach modernsten Fertigungsmethoden hergestelltes Produkt. Es wurde nach den Regeln unseres Qualitätsmanagementsystems entwickelt, gefertigt und geprüft. Das Rohde & Schwarz-Qualitätsmanagementsystem ist u.a. nach ISO 9001 und ISO 14001 zertifiziert.

### Certificate of quality

Dear Customer,

You have decided to buy a Rohde & Schwarz product. You are thus assured of receiving a product that is manufactured using the most modern methods available. This product was developed, manufactured and tested in compliance with our quality management system standards. The Rohde & Schwarz quality management system is certified according to standards such as ISO 9001 and ISO 14001.

### Certificat de qualité

Cher client,

Vous avez choisi d'acheter un produit Rohde & Schwarz. Vous disposez donc d'un produit fabriqué d'après les méthodes les plus avancées. Le développement, la fabrication et les tests respectent nos normes de gestion qualité. Le système de gestion qualité de Rohde & Schwarz a été homologué, entre autres, conformément aux normes ISO 9001 et ISO 14001.



**ROHDE & SCHWARZ**



# Customer Support

## Technical support – where and when you need it

For quick, expert help with any Rohde & Schwarz equipment, contact one of our Customer Support Centers. A team of highly qualified engineers provides telephone support and will work with you to find a solution to your query on any aspect of the operation, programming or applications of Rohde & Schwarz equipment.

## Up-to-date information and upgrades

To keep your Rohde & Schwarz equipment always up-to-date, please subscribe to our electronic newsletter at

<http://www.rohde-schwarz.com/www/response.nsf/newsletterpreselection>

or request the desired information and upgrades via email from your Customer Support Center (addresses see below).

## Feedback

We want to know if we are meeting your support needs. If you have any comments please email us and let us know [CustomerSupport.Feedback@rohde-schwarz.com](mailto:CustomerSupport.Feedback@rohde-schwarz.com).

---

---

### USA & Canada

Monday to Friday (except US public holidays)

8:00 AM – 8:00 PM Eastern Standard Time (EST)

Tel. from USA 888-test-rsa (888-837-8772) (opt 2)

From outside USA +1 410 910 7800 (opt 2)

Fax +1 410 910 7801

E-mail [Customer.Support@rsa.rohde-schwarz.com](mailto:Customer.Support@rsa.rohde-schwarz.com)

### East Asia

Monday to Friday (except Singaporean public holidays)

8:30 AM – 6:00 PM Singapore Time (SGT)

Tel. +65 6 513 0488

Fax +65 6 846 1090

E-mail [Customersupport.asia@rohde-schwarz.com](mailto:Customersupport.asia@rohde-schwarz.com)

### Rest of the World

Monday to Friday (except German public holidays)

08:00 – 17:00 Central European Time (CET)

Tel. from Europe +49 (0) 180 512 42 42

From outside Europe +49 89 4129 13776

Fax +49 (0) 89 41 29 637 78

E-mail [CustomerSupport@rohde-schwarz.com](mailto:CustomerSupport@rohde-schwarz.com)





## Contents of User Documentation for Vector Signal Generator R&S SMATE200A

The user documentation describes the Vector Signal Generator R&S SMATE and all options. It includes a printed Quick Start Guide and a CD-ROM. The CD-ROM provides the complete user documentation for the vector signal generator:

The R&S SMATE is equipped with a context-sensitive online help that offers a help page for each instrument function.

### Quick Start Guide



The present quick start guide describes everything that is needed to put the instrument into operation and to get familiar with the generator. The quick start guide gives an introduction to remote control and manual control via external monitor, mouse and keyboard.

The quick start guide is subdivided into the data sheet plus 4 chapters plus index:

**The data sheet** informs about guaranteed specifications and characteristics of the instrument.

**Chapter 1** Describes the control elements and connectors on the front and rear panel as well as all procedures required for putting the instrument into operation.

**Chapter 2** Gives an introduction the operating concept and typical applications of the R&S SMATE.

**Chapter 3** Describes key operating modes, the structure of the graphical interface and the principles of manual control.

**Chapter 5** describes the basics for programming the R&S SMATE, command processing and the status reporting system.

**Annex** Contains an index for the quick start guide.

### Help System



The help system is embedded in the instrument, offering quick, context-sensitive reference to the information needed for operation and programming. The help contains the complete user documentation for the vector signal generator including the contents of the present quick start guide.

To access the context-sensitive help, an external monitor and mouse must be connected to the instrument (see chapter 3 of this quick start guide).

The help files (\*.chm) are also available on the CD-ROM and can be used as a standalone help.

## Documentation CD-ROM

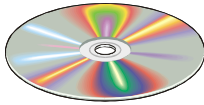

The CD-ROM provides the complete user documentation for the vector signal generator:

- The online help system (\*.chm).
- The complete operating manual and service manual in printable form (\*.pdf).
- The data sheet (brochure and specifications) in printable form.
- Links to different useful sites in the R&S internet.

---

**Note:** Please use the ADOBE® Acrobat® Reader for PDF files and the browser Internet Explorer® 4.0 for the HTML help.

---

## Operating Manual

The operating manual contains comprehensive information about the instrument functions and remote control, in addition to the chapters of the quick start guide. It includes information about maintenance of the instrument and about error detection listing the error messages which may be output by the instrument. It is subdivided into 10 chapters:

- |                       |   |
|-----------------------|---|
| <b>The data sheet</b> | informs about guaranteed specifications and characteristics of the instrument.  |
| <b>Chapter 1</b>      | describes the control elements and connectors on the front and rear panel as well as all procedures required for putting the instrument into operation.   |
| <b>Chapter 2</b>      | gives an introduction to the operating concept and typical applications of the R&S SMATE.   |
| <b>Chapter 3</b>      | describes key operating modes, the structure of the graphical interface and the principles of manual control.   |
| <b>Chapter 4</b>      | forms a reference for manual control of the R&S SMATE and contains a detailed description of all instrument functions and their application. The chapter also lists the remote control command corresponding to each instrument function. |

<b>Chapter 5</b>	describes the basics for programming the R&S SMATE, command processing and the status reporting system.
<b>Chapter 6</b>	lists all the remote-control commands defined for the instrument. At the end of the chapter a alphabetical list of commands.
<b>Chapter 7</b>	-
<b>Chapter 8</b>	describes preventive maintenance and the characteristics of the instrument's interfaces.
<b>Chapter 9</b>	gives the status messages and a list of error messages that the R&S SMATE may generate.
<b>Chapter 10</b>	contains an index for the operating manual.

## Service Manual Instrument

The service manual - instrument informs on how to check compliance with rated specifications, on instrument function, repair, troubleshooting and fault elimination. It contains all information required for the maintenance of R&S SMATE by exchanging modules. In addition it describes how to perform a firmware update and how to install options.

## Optional Documentation

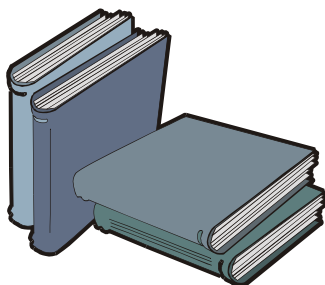

The printed version of the operating and service manual provides the contents of the quick start manual plus the complete reference and the service information for the vector signal generator. This manual can be ordered as an option (stock no. 1401.0940.39); see ordering information in the data sheet.

**Note:** The CD-ROM contains the \*.pdf version of the manuals.

## Internet Site

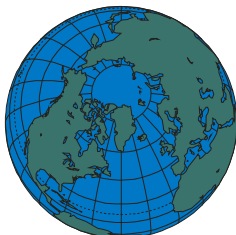

The Internet site at: [R&S Vector Signal Generator R&S SMATE200A](#) provides the most up to date information on the R&S SMATE. The current operating manual at a time is available as printable PDF file in the download area.

Also provided for download are firmware updates including the associated release notes, instrument drivers, current data sheets and application notes,





## Contents - Chapter 1 "Putting into Operation"

<b>1 Putting into Operation .....</b>	<b>1.1</b>
Introduction - Putting into Operation.....	1.1
Legend for Front Panel View.....	1.1
Legend for Rear Panel View.....	1.4
Putting into Operation.....	1.12
Unpacking the Instrument .....	1.12
Installing the Instrument in a 19" Rack.....	1.12
Safety Instructions.....	1.13
EMC Safety Precautions .....	1.13
Connecting the R&S SMATE to the AC Supply .....	1.14
Switching On .....	1.14
Booting the R&S SMATE .....	1.14
Switching Off .....	1.15
Function Check.....	1.16
Default Settings .....	1.16
Windows XP Embedded.....	1.17
Connecting an External Keyboard.....	1.18
Connecting the Mouse.....	1.18
Connecting an External Monitor .....	1.19
Connecting the R&S SMATE to a Network (LAN).....	1.20
Connection to the Network.....	1.20
Manual Remote Control via an External Controller .....	1.28
Configuration for Manual Remote Control via Windows Remote Desktop Connection .....	1.28
Configuration for Manual Remote Control via Ultr@VNC .....	1.33
Using Norton Antivirus.....	1.40
Preparing the Installation of Norton Antivirus.....	1.40

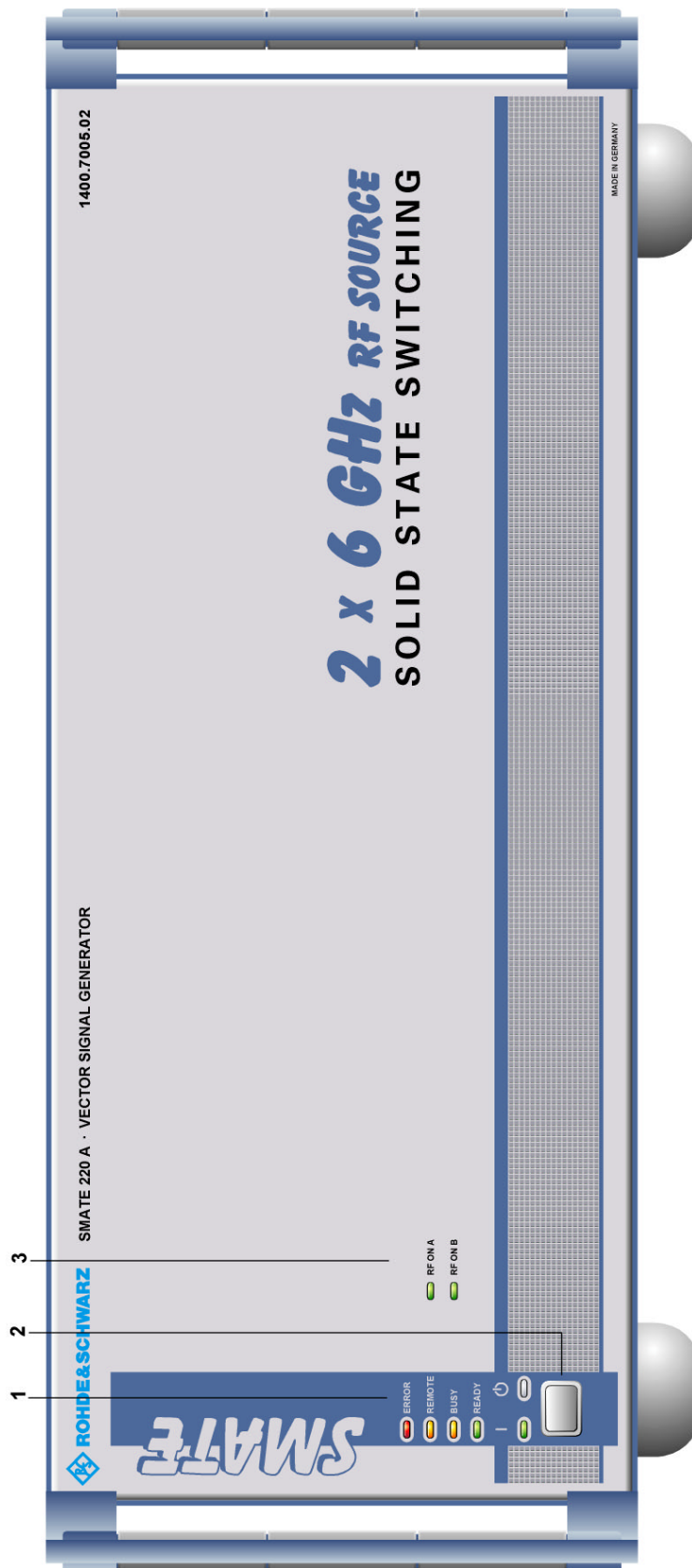

Figure 1-1 Front panel view

# 1 Putting into Operation

## Introduction - Putting into Operation

Chapter 1, "Putting into Operation" explains the control elements and connectors of the Vector Signal Generator R&S SMATE with the aid of the front and rear views and describes how to put the instrument into operation. It also describes the connection of peripherals such as printer, keyboard, mouse and monitor. A detailed description of the I/O interfaces is given in section "[Legend for Rear Panel View](#)", on page 1.4, and of the remote control interfaces in section "[Remote Control Hardware Interfaces](#)", on page 5.28. Specifications of interfaces can be seen in the data sheet.

The R&S SMATE is primarily intended to be remote-controlled via the GPIB interface or a LAN connection (see section "[Switchover to Remote Control](#)", on page 5.3.). Alternatively it is possible to control the instrument manually using an external monitor in combination with a keyboard and a mouse (see section "[Introduction - Manual Operation](#)", on page 3.1) or by accessing the instrument via the remote control desktop of an external PC (see section "[Manual Remote Control via an External Controller](#)", on page 1.28).

Several hardware control lines are provided for direct and fast access to instrument functions, e.g. to RF OFF and MOD OFF switching (see "[Legend for Rear Panel View](#)", Digital I/Q Interface).

Manual and remote control of the R&S SMATE are described in separate chapters. Background information about the settings and about the digital standards is reported in the reference chapter for manual control (Chapter 4, "[Instrument Functions](#)"), together with the menus that may be displayed on an external monitor.

To avoid redundancy, the reference chapter for remote control (Chapter 6) focusses on program syntax and parameter ranges but contains only a short description of the command functions.

Chapter 2, "[Getting Started](#)" gives an overview of generator functions. Detailed operating instructions and an overview of menus follow in Chapter 3, "[Manual Operation](#)". Chapter 5, "[Remote Control - Basics](#)" describes how to switchover to remote control.

The complete manual on the CD-ROM in printable pdf-format provides chapters 4 to 9.

## Legend for Front Panel View

This section gives an overview of control elements on the front panel of the R&S SMATE. The connectors of the R&S SMATE are placed on the rear panel and are described in the following section "[Legend for Rear Panel View](#)".

As the R&S SMATE is mainly intended to be remote-controlled, the front panel of the R&S SMATE contains no display but mostly LEDs to inform the user about the status of the instrument. The user interface can be displayed on an external monitor that is either connected directly to the instrument or that belongs to a remote PC station used to manually remote control the instrument.

**1 Status LEDs for instrument state**



- ERROR** Indicates that an error occurred during operation. Only errors are indicated that impair further instrument operation, e.g. a hardware fault. The error must be eliminated before correct instrument operation can be ensured. The error can be queried with commands `SYSTem:ERRor:ALL`, `SYSTem:ERRor[:NEXT]`, and `SYSTem:SERRor`.
- REMOTE** Indicates that the instrument is in remote control mode. If using an external monitor and an external keyboard, the external display remains unchanged and shows the current instrument status, i.e. the status which exists under the remote control settings. The instrument can be operated (e.g. menus can be opened). However, it is not possible to enter or change values.
- BUSY** Indicates that the instrument is booting the operating system and firmware software.
- READY** Indicates that the instrument is ready for operation after booting the instrument.

See chapter 6, section "[Setting Parameters](#)"

**2 Switch**



The on/off switch switches the instrument from the standby mode to the operating state provided the power switch on the instrument rear is switched on. The yellow LED (right) is on in the standby mode; the green LED (left) is on when the instrument is ready for operation.

See chapter 1, section "[Switching On](#)"



**Warning!**  
*The AC line is still connected to the instrument in the standby mode.*

**3 Status LEDs for RF outputs**



- RF ON A** Indicates that RF output A on the rear of the instrument is switched on.
- RF ON B** Indicates that RF output B on the rear of the instrument is switched on.

See data sheet

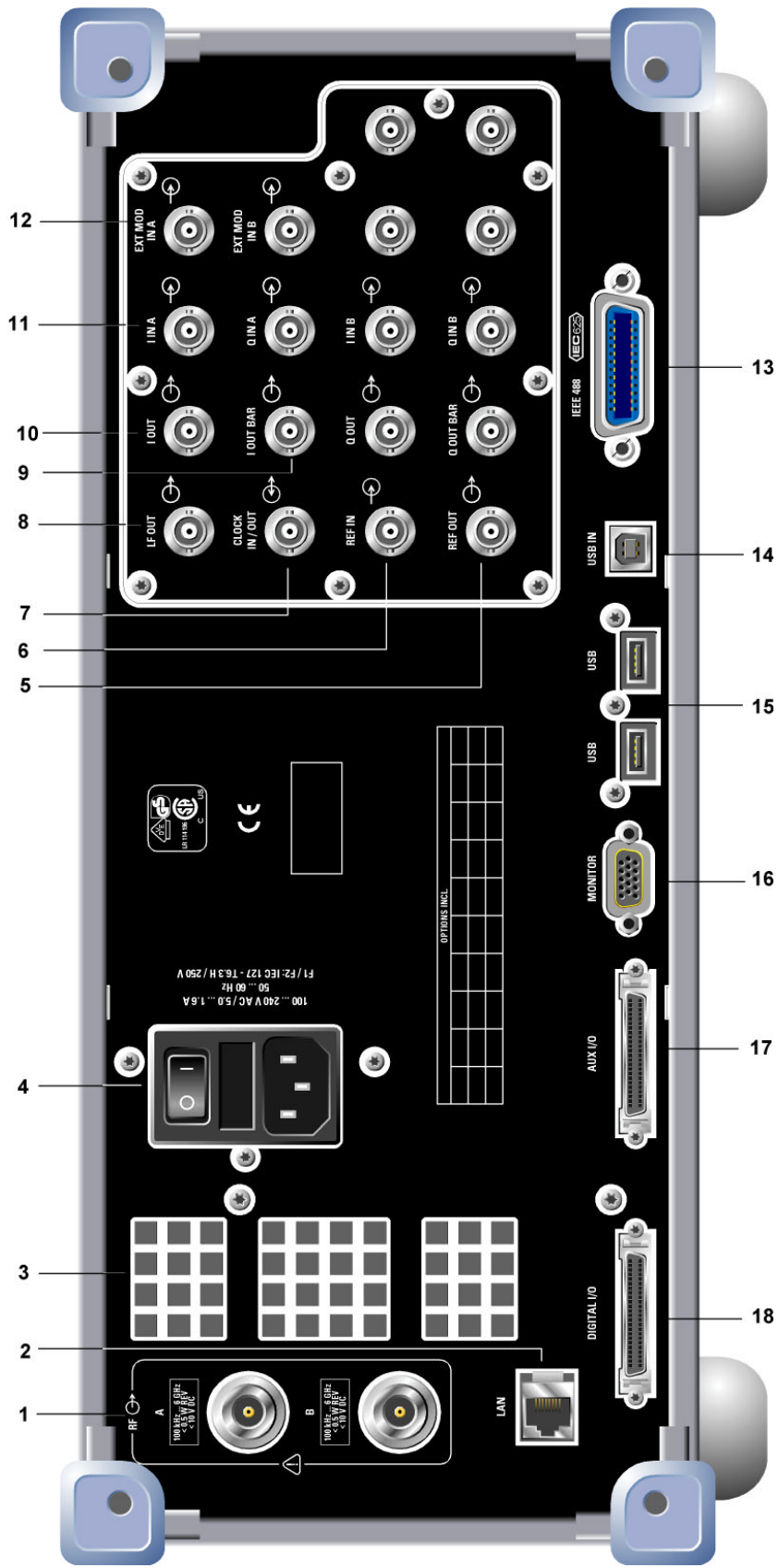

Fig. 1-2 Rear panel view

## Legend for Rear Panel View

This section gives an overview of connectors on the rear panel of the R&S SMATE. Each connector is briefly described and a reference is given to the chapters containing detailed information. For technical data of the connectors refer to the data sheet. If a connector of a two-path instrument is available for one path only (e.g. path A) or for either of the two (path A or B), a note is made in the brief description.

### 1 RF outputs A and B



Outputs for RF signal of path A and B.



#### Caution

Do not overload the RF outputs. The maximum permissible back-feed is specified in the data sheet.

See data sheet

### 2 LAN interface



LAN

Ethernet interface

- For integrating signal generators in a network
- Remote control of signal generator
- Input of external asynchronous data
- Manual remote control of signal generator
- Firmware update

See data sheet and chapter 1, section "[Connecting the R&S SMATE to a Network \(LAN\)](#)", on page 1.20, section "[LAN Connector](#)" on page 5.31, and chapter 5, section "[Remote Control via LAN Interface](#)" on page 5.5.

**3 Ventilation slots**



**Caution**

*Ventilation slots must not be obstructed. Make sure that the air can escape freely through the vents at the rear. The minimum distance to the wall should be at least 10 cm.*

See chapter 1, section "[General Precautions](#)" and data sheet

**4 AC supply**



Power switch

Power connector

AC power connector.

When the R&S SMATE is connected to the AC supply, it automatically sets itself to the correct range for the applied voltage (range: see type label). There is no need to set the voltage manually or change fuses.

See chapter 1, section "[Connecting the R&S SMATE to the AC Supply](#)" and data sheet

Power switch.

The power switch can be set to two positions.

- 0** The instrument is disconnected from the mains
- I** The instrument is power-supplied. It is either ready for operation (STANDBY) or in operating mode, depending on the position of the ON/STANDBY switch on the instrument front

**5 Reference signal output**



REF OUT

Output for external reference signal

See data sheet and chapter 4, section "[RF Reference Frequency - Reference Oscillator](#)"

**6 Reference signal input**



REF IN

Input for external reference signal (the external reference is used for both paths)

See data sheet and chapter 4, section "[RF Reference Frequency - Reference Oscillator](#)"

**7 Clock signal input/output**



**CLOCK IN**

Input for external clock signal (bit or symbol clock, multiple of symbol clock) for synchronizing the external data signal in case of multivalent modulation. The active edge can be set (path A only).

**CLOCK OUT**

Output for internal (bit or symbol) clock signal (path A, the internal clock signal of path B can be output at one of the USER interfaces)

See data sheet and chapter 4, section "[Data and Signal Sources in Baseband](#)"

**8 LF output**



**LF OUT**

Output for internal LF generator signal (path A only).

See chapter 4, section "[LF Generator and LF Output - LF Output](#)" and data sheet

**9 Differential I/Q outputs**



**I OUT BAR/ Q OUT BAR**

Differential (inverting) outputs for analog I/Q signal either from path A or path B.

See data sheet and chapter 4, section "[Impairment of Digital I/Q Signal](#)"

**10 Single ended or differential I/Q outputs**



**I OUT / Q OUT**

Single-ended or differential (non-inverting) outputs for analog I/Q signal either from path A or path B.

See data sheet and chapter 4, section "[Impairment of Digital I/Q Signal](#)"

**11 I/Q signal input**

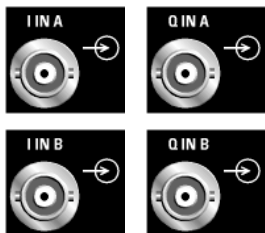

**I IN A/B and Q IN A/B**

Input for external analog modulation signal in case of I/Q modulation (independent for RF path A and B) or Input for external analog baseband signal (option B17, Baseband Input)

See data sheet and chapter 4, sections "[Data and Signal Sources in Baseband](#)", "[I/Q Settings Menu](#)", and

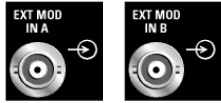

**12 Input for external modulation signal****EXT MOD IN A/B**

Input for external analog modulation signals for amplitude, frequency, phase and pulse modulation (independent for RF path A and B)

See data sheet and chapter 4, section "[Modulation Sources](#)"

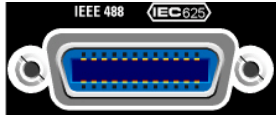
**13 IEC/IEEE-bus connector****IEC 625/IEEE 488**

IEC-bus (IEEE 488) interface for remote control of the R&S SMATE

See data sheet and section "[IEC/IEEE Bus Interface](#)", on page 5.28

**14 USB interface type B**

USB (universal serial bus) interface of type B (device USB).

- Input for external asynchronous modulation data (path A only)

The interface establishes a connection to the DACIF module. If required, separate drivers can be developed for this interface. The device ID required in this case is 11 (HEX) for remote control and 12 (HEX) for the transmission of modulation data. The vendor ID is AAD (HEX).

See data sheet

**15 USB connectors type A**

USB (universal serial bus) interfaces of type A (host USB).

- Connection of peripherals such as mouse, keyboard, printer
- Connection of memory stick for file transmission
- Firmware update

The interface establishes a connection to the controller.

See chapter 1, section "[Connecting the Mouse](#)", , on page 1.18 and section "[Connecting an External Keyboard](#)", on page 1.18

16 Monitor



MONITOR

The 15-pin Sub-D female connector is intended for connecting an external VGA monitor.

See data sheet and chapter 1, section "[Connecting an External Monitor](#)"

Pin	Signal
1	Red (output)
2	Green (output)
3	Blue (output)
4 / 11 / 12 / 15	Not connected
5... 10 - ⊥	Ground
13	HSYNC (output)
14	VSYNC (output)

17 AUX I/O interface

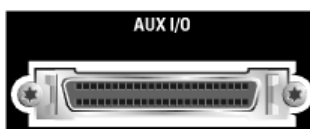

AUX I/O

Parallel input/output for data signals as well as settable trigger and control signals of the baseband. Input for device trigger for path B.

Assignment of the AUX I/O interface and of USER pins, and the arbitrary assignment of pins to path A or B can be configured in the **Setup** menu under **Environment - Global Trigger/Clock/External Inputs - USER Marker / AUX I/O Settings**.

An adapter of the AUX I/O interface to coaxial BNC connectors is available as an accessory (R&S SMATE-Z5, see data sheet).

See chapter 4, section "[Global Trigger/Clock/Input Settings – Setup - Environment](#)" and data sheet

Connection	Description
1... 25 - ⊥	Ground
26 - LEV ATT	Signal input/output for controlling the level attenuation (path A only). With active envelope curve control, this signal determines whether or not the signal level is attenuated. With external envelope curve control ( <b>Custom Digital Modulation</b> only), the pin is the input for the control signal LEV_ATT. With internal envelope curve control, the control signal LEV_ATT is output for Path A. With two-path instruments, the signal for path B can be applied to one of the user interfaces.

Connection	Description
27 - CW MODE	<p>Signal input for controlling the switchover between the modulated and unmodulated RF signal with activated external modulation/CW switching in the <b>Custom Digital Modulation</b> menu (CW control signal, path A and/or path B).</p> <p>Signal output for the CW control signal with internal source selected. This signal marks the CW mode in which digital modulation is deactivated and the RF signal is output in unmodulated form. In the case of digital standards with selectable modulation mode, the signal indicates the active modulation mode (GSM: (G)MSK = high, 8PSK EDGE = low)</p>
28 - INST TRIG B	<p>Input for external triggering of the analog modulations, sweeps and List mode. HOP input for controlling the frequency hopping mode with external source in List mode (Path B). The instrument trigger input for Path A is input via the connector DIGITAL I/O.</p>
29 - PARDATA0 ...	Parallel data input/output 0...D with 10-bit word width for digital modulation. If the data source "external parallel" is selected, these pins are the data inputs. If a different data source is selected, the data is output here ( <b>Custom Digital Modulation</b> , Path A).
38 - PARDATA9	
39 - USER 3	<p>USER input/output which can be configured for various purposes The following signals can be applied at the connector:</p> <ul style="list-style-type: none"> <li>- <b>Marker 4</b> (output Path A or B).</li> <li>- <b>CW Mode Out</b> (output Path A or B).</li> <li>- <b>No Signal (Blank) Marker</b> (output Path A or B). This signal marks the blank time in the List mode.</li> <li>- <b>HOP</b> (output path A or B). This signal marks the trigger for frequency hopping in the List mode.</li> <li>- <b>Trigger</b> (output path A or B). This signal marks the trigger event caused by the selected trigger signal (internally or externally) of path A or B.</li> </ul> <p>Additional signals for path B are available in the case of two-path instruments. The corresponding signals for Path A are applied at the pins of the AUX I/O or DIGITAL I/O interface (Clock Out).</p> <ul style="list-style-type: none"> <li>- <b>Clock Out</b> (output Path B; bit or symbol clock pulse). This signal corresponds to the clock signal for digital modulations.</li> <li>- <b>LEV ATT</b> (input/output path B).</li> <li>- <b>BURST (input/output path B)</b>.</li> </ul>
40 - USER 4	USER input/output which can be configured for various purposes (see above, USER 3).
41 - MARKER 3	Output for the freely programmable marker signal 3 of Path A. The output is permanently assigned.
42 - MARKER 2 B	Output for the freely programmable marker signal 2 of Path B.
43 - MARKER 3 B	Output for the freely programmable marker signal 3 of Path B. The output is permanently assigned.
44 - not used	Pin is not used.
45 - BURST	<p>Signal input/output for controlling the burst ramp (Path A). With external envelope curve control (<b>Custom Digital Modulation</b> only), the pin is the input for the control signal BURST_RAMP. With internal envelope curve control, the control signal BURST_RAMP is output for Path A. With two-path instruments, the signal for Path B can be applied to one of the user interfaces.</p>
46 - EXT TUNE	Tuning input for the internal reference frequency.
47 - BITCLK	<p>Output Bit clock for internal mode (Path A only). With two-path instruments, the signal for Path B can be applied to one of the user interfaces.</p>
48 - USER 2	USER input/output which can be configured for various purposes (see above, USER 3).
49 - SYMBCLK	<p>Symbol clock output for internal mode (Path A only). With two-path instruments, the signal for Path B can be applied to one of the user interfaces.</p>
50 - not used	Pin is not used.

## 18 Digital I/O interface

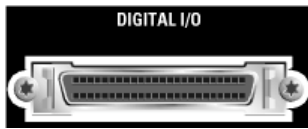
**DIGITAL I/O**

Input/output for serial data of digital signals as well as settable trigger and control signals of the baseband.  
Input for device trigger for path A.

Assignment of most of the pins of the DIGITAL I/O interface is permanent and cannot be changed. Some of the pins are assigned the same input/output as pins of the AUX I/O interface, e.g. CLK OUT. This is provided to enable the use of a single connector for the input of parallel or serial data.

Assignment of the USER pin can be configured in the **SETUP** menu under **Environment - Global Trigger/Clock/External Inputs - USER Marker / AUX I/O Settings** (command :OUTPut:USER).

An adapter of the DIGITAL I/O interface to coaxial BNC connectors is available as an accessory (R&S SMATE-Z5, see data sheet).

See chapter 4, section "Global Trigger/Clock/Input Settings – Setup - Environment" and data sheet

Connection	Description
1... 25 - ⊥	Ground
26 - TRIGGER 1	Input for triggering digital modulations, digital standards and ARB (paths A and/or B).
27 - TRIGGER 2	Input for triggering digital modulations and standards and ARB (paths A and/or B).
28 - MARKER 1	Output for the freely programmable marker signal 1 of path A for triggering and control of external devices.
29 - MARKER 2	Output for the freely programmable marker signal 2 of path A for triggering and control of external devices.
30 - MARKER 1 B	Output for the freely programmable marker signal 1 of path B for triggering and control of external devices.
31 - USER 1	Input/output for configurable signals for triggering and control. The following signals can be applied to the connector: - Marker 3/4 (path A or B) - Clock Out (path B, bit or symbol) - CW mode Out (path A/B) - No signal (blank) marker (path A/B) - HOP (path A/B)  More USER input/outputs are available on the AUX I/O interface.
32 - INST TRIG A	Input for external triggering of the analog modulations, sweeps and List mode. HOP input for controlling the frequency hopping mode with external source in List mode (path A). The instrument trigger for path B is input via the connector AUX I/O.
33 - CLK OUT	Output for internal (bit or symbol) clock signal (path A, the internal clock signal of path B can be output at one of the USER interfaces). This output is also provided via the connector AUX I/O to enable the use of a single connector for the input of parallel data.

Connection	Description
34 - DATA	Serial data input/output for digital modulation of path A. If the data source "external serial" is selected, these pin is the data input. If an internal data source is selected, the data is output here ( <b>Custom Digital Modulation</b> , path A).
35...38 - not used	Pins are not used.
39 - OPC A	Output for Operation Complete signal of path A. Active High signals that all remote control commands have been executed. The output is always active.
40 - RF OFF A	Input for fast switching of the RF output A (see chapter 4, section " <a href="#">Level - EMF Menu</a> ").  The input must be activated in the <b>Level/EMF</b> menu or via remote control command. Active High (1) switches the RF output off. A subsequent Active Low (0) switches the RF output on again. The RF Output must be switched on when the input is activated, otherwise the control signal has no effect on the status of the RF Output. Switching is performed very fast (10µs). However, the attenuation of the switched off output is considerably less than after regular switch-off, because the connection between the RF output and attenuator is not interrupted.
41 - MOD OFF A	Input for fast switching of I/Q modulator of path A (see chapter 4, section " <a href="#">Level - EMF Menu</a> ").  The input must be activated in the <b>Level/EMF</b> menu or via remote control command. Active High (1) switches the modulations off. A subsequent Active Low (0) switches the modulations on again. The modulations must be switched on when the input is activated, otherwise the control signal has no effect on the status of the modulations. Switching is performed very fast (10µs). The control signal has no effect on the status of the digital modulations in the baseband block or of the analog modulation of the RF block. An exception is broadband amplitude modulation which uses the I/Q modulator.
42 - OPC B	Output for Operation Complete signal of path B. This signal indicates that all remote control commands have been executed. The line is always active.
43 - RF OFF B	Input for fast switching off the RF output B (see pin 40).
44 - MOD OFF B	Input for fast switching off I/Q modulation and broadband amplitude modulation of path B (see pin 41).
45 - FHOP_DATA	Data input for Fast Hop list mode (see chapter 4, section " <a href="#">List Mode</a> ")
46 - FHOP_CLK	Clock input for Fast Hop list mode (see chapter 4, section " <a href="#">List Mode</a> ").
47 - FHOP_STRB	Strobe input for Fast Hop list mode (see chapter 4, section " <a href="#">List Mode</a> ").
48...50 - not used	Pins are not used.

## Putting into Operation

The following section describes the procedure for putting of the instrument into operation and the connection of peripherals such as printer and monitor. It contains general safety instructions for instrument operation.

The installation of options and the firmware update are described in Chapter 4 of the Service Manual (supplied with the instrument on the CD-ROM).

### Unpacking the Instrument

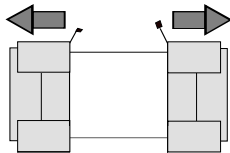

Remove protective covers

- Remove the instrument from its packaging and check the equipment for completeness using the delivery note and the accessory lists for the separate items.
- Remove the two protective covers from the front and rear panel of the signal generator and carefully check the instrument for damage.
- If there is damage, immediately contact the carrier who delivered the instrument. In this case, make sure not to discard the box and packing material.
- The original packaging is also useful for transporting or shipping the signal generator later on. It is recommended to keep at least the two protective caps for front and rear side in order to prevent damage to the controls and connectors.

### Installing the Instrument in a 19" Rack

The instrument is designed for indoors use in a 19" rack.

A rack adapter or an adapter for telescopic sliders (refer to data sheet for Order No.) is required for installation in a 19" rack. The mounting instructions are supplied with the adapter.



#### Caution!

*Prior to putting the instrument into operation, check the following:*

- Allow for sufficient air supply in the rack.
- Make sure that there is sufficient space between the ventilation holes and the rack casing.

## Safety Instructions

### General Precautions

**Caution!**

*Prior to putting the instrument into operation, check the following:*

- *The covers of the housing are in place and screwed on,*
- *Vents are not obstructed. Make sure that the air can escape freely through the vents at the rear and at the sides. The minimum distance to the wall should therefore be at least 10 cm.*
- *The signal levels at the inputs do not exceed permissible limits.*
- *The outputs of the instrument are not overloaded or incorrectly connected. This particularly applies to the maximum permissible back-feed at the RF outputs, which is specified in the data sheet.*
- *The instrument should only be operated in horizontal position on an even surface.*
- *The ambient temperature must not exceed the range specified in the data sheet.*

*Any non-compliance with these precautions may cause damage to the instrument. Please also observe the instructions in the following sections and the general safety instructions at the beginning of this manual.*

### Protection against Electrostatics



*To avoid damaging the electronic components of the EUT due to electrostatics produced by contact, the use of appropriate protective measures is recommended.*

### EMC Safety Precautions

To avoid electromagnetic interference, only suitable, shielded signal and control cables must be used (see recommended extras).

## Connecting the R&S SMATE to the AC Supply

The R&S SMATE is automatically matched to the applied AC voltage (see rear panel). There is no need to set the voltage manually or change fuses. The AC supply connector is at the rear of the unit (see below).

The nominal voltage and frequencies ranges are displayed on the rear panel and quoted in the data sheet

Since the instrument is in compliance with safety class EN61010-1, it should only be connected to a socket with earthing contact.

## Switching On

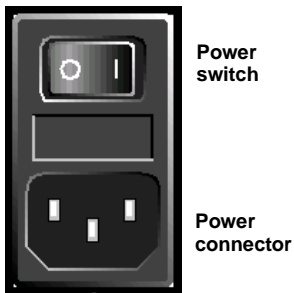

- Connect the signal generator to the AC supply by means of the supplied power cable.
- Press the main power switch at the rear of the instrument to position I.
- After power-up the instrument is either ready for operation (STANDBY) or in operating mode, depending on the position of the ON/STANDBY switch on the instrument front (see below).

---

**Note:** *The power switch may remain on for any period of time. Switching off is required only if the instrument should be completely isolated from the AC supply.*

---



- Press the ON/STANDBY switch on the front panel; the green LED must be on.
- The instrument is ready for operation. All modules in the instrument are supplied with power.

## Booting the R&S SMATE

After instrument switch-on, the Windows XP Embedded operating system and subsequently the instrument firmware boots. During booting of the instrument firmware, a selftest is performed. On the front panel LED **BUSY** indicates that the instrument is booting.

After booting is completed, the front panel LED **READY** indicates that the instrument is ready to be operated. The settings that were active before the last switch-off are established.

If an external monitor is connected to the instrument, the installed BIOS version and the processor characteristics are indicated for a few seconds in the start display after instrument switch-on. After booting is completed, the block diagram of the signal generator is displayed and the instrument is ready to be operated.

---

**Note:** *If the software stops unexpectedly, the instrument can be rebooted by pressing the STANDBY key for approx. 5 s.*

---



## Switching Off



- Press the ON/STANDBY switch on the front panel.

The R&S SMATE stores the current setting on the hard disk before it shuts down the Windows operating system. Then the AC supply is switched to the STANDBY mode.

- Only the AC supply is powered and the oven-controlled crystal oscillator is kept at operating temperature.
- The yellow LED must be on.



**Warning:**

*The instrument is still connected to the AC supply when the instrument is in the standby mode.*

Do the following only if the instrument is completely disconnected from the AC supply:

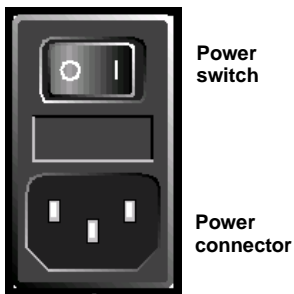

- Press the main power switch at the rear of the instrument to position 0. None of the front-panel LEDs should be on.

---

**Note:** *It is recommended to switch the instrument to STANDBY mode before completely disconnecting it from the AC supply. If the power switch is set to 0 before the instrument is switched to the standby mode, all current settings are lost.*

---

## Function Check

The signal generator automatically monitors the main functions when the instrument is switched on and continuously during operation.

If a fault is detected, the front panel LED **ERROR** indicates the error state. The error can be queried with commands `SYSTem:ERRor:ALL`, `SYSTem:ERRor[:NEXT]`, and `SYSTem:SError`. See Chapter 6, section "[System Subsystem](#)" and Chapter 9, [Error Messages](#)".

If an external monitor is connected to the instrument, ERROR is displayed in the info line together with a brief error description.

For in-depth identification of the error, press the `INFO` key. In response, a description of the error(s) is displayed (see

Besides automatic monitoring of instrument functions, other capabilities in the R&S SMATE ensure correct functioning of the vector signal generator.

- **Internal Adjustments**

Adjustments can be performed with commands of the CALibrate Subsystem or in the **Setup-System-Internal Adjustments** menu (with external monitor and keyboard). Thus maximum level accuracy can be obtained, for instance. See Chapter 6, section "[Calibration Subsystem](#)" and Chapter 4, section "[Internal Adjustments - Setup-System](#)".

- **Test points**

Internal test points can be queried by the user with commands of the DIAGnostic Subsystem or in the **Setup-Test-Test Points** menu (with external monitor and keyboard). See Chapter 6, section "[Diagnostic Subsystem](#)" and Chapter 4, section "[Test Point... - Setup-Test](#)".

## Default Settings

The instrument is set to a defined state with common command `*RST` or the `ALT` + `P` key combination on an external keyboard.

RF frequency	1 GHz
RF level	OFF
Reference frequency	internal, adjustment off
Offsets	0
Modulations	switched off
Uninterrupted level setting	switched off; level attenuator mode: AUTO
Internal level control	Level ALC: AUTO
User correction	Level Ucor: OFF
LF output	switched off
Sweep	switched off
LIST mode	switched off
IEC/IEEE-bus address	not changed

With preset, all parameters and switch states are preset, including those of deactivated operating modes.

Presettings beyond those in the above list can be seen in the preset tables in Chapter 4 or from the `*RST` values of the associated IEC/IEEE-bus commands.

# Windows XP Embedded

**Caution:**

*Drivers and programs used in the instrument under Windows XP have been adapted to the signal generator. To avoid impairment of instrument functions, only the settings described below are permissible. Existing software must only be modified with update software released by Rohde & Schwarz. Likewise, only programs authorized by Rohde & Schwarz for use on the instrument must be executed.*

*The following program packages have been successfully tested for compatibility with the measurement instrument software:*

- R&S Power Viewer (virtual power meter for displaying results of the Power Sensor R&S NRP-Zxx)
- Windows XP Remote Desktop
- Symantec Norton AntiVirus – Virus-protection software

The signal generator is equipped with the Windows XP Embedded operating system. The configuration of the operating system is optimally adapted to signal generator functions in the factory. Changes in the system setup are only required when peripherals like a printer is installed or in the event that the network configuration does not comply with the default settings (see section "[Connecting the R&S SMATE to a Network \(LAN\)](#)").

After power-up of the signal generator, the operating system boots and the instrument firmware is started automatically without a password query (auto login).

**Note:** *Auto login is performed with the user name and the password "instrument". The standard user has administrator rights so that printer and network installations are possible.*

The operating system can only be accessed if an external keyboard and/or a mouse and an external monitor are connected, an access via remote control commands is not possible. Windows XP provides an on-screen keyboard that can be operated using a mouse, thus enabling operation by mouse only. An external keyboard is recommended for extensive entries.

System settings under Windows XP can be made in the **Start - Control Panel** menu (for required settings refer to the Windows XP manual and to the hardware description).

The Windows XP start menu is opened with the **Windows** key (next to the Ctrl key) or with key combination CTRL-ESC on the external/on-screen keyboard. In this menu the Windows XP programs can be called. Some of the programs are also placed as symbols on the Windows task bar and can be called directly by double-clicking the associated symbol. The Windows XP desktop including the task bar is displayed when moving the mouse to the bottom of the display.



The instrument display with block diagram, header and Winbar is displayed in the foreground by double-clicking the **Block Diagram**, **StatusBar** and **TaskBar** buttons in the Windows task bar.

The R&S SMATE does not contain a disk drive. Data is exchanged via a memory stick connected to a USB interface. An unused disk drive letter is automatically assigned to the memory stick. Data can be transferred in Windows Explorer.

**Energy saving mode:**

An energy saving mode is a default setting in the R&S SMATE. The hard disk switches to power-save mode if it is not accessed for 30 minutes. The energy-saving mode is exited by accessing the hard disk anew.

## Connecting an External Keyboard

A commercial, external keyboard with USB interface can be connected to the R&S SMATE. A keyboard is a prerequisite for manual control of the instrument and for operation of Windows XP without a Remote Desktop connection to an external PC.

The keyboard is connected to a USB interface, type A, on the rear panel of the instrument.

1    **USB**    2



The keyboard is detected automatically when it is connected. The UK keyboard assignment is the default setting. The keyboard assignment and special settings such as the refresh rate can be changed in the **Start - Control Panel - Keyboard** or **Regional and Language Options** menu of Windows XP. The menu can be accessed by pressing the **Windows** key on the external keyboard.

---

**Note:** *A keyboard emulation can be called from the Windows XP operating system (START - Programs - Accessories - Accessibility - On-Screen Keyboard). With the On-Screen Keyboard it is possible to manually operate the instrument using the mouse only.*

---

## Connecting the Mouse

A commercial mouse with a USB interface can be connected to the R&S SMATE. A mouse simplifies control of the block diagram and of associated menus in manual control. It is sufficient for operation of Windows XP when used together with the on-screen keyboard.

The mouse is connected to one of the USB interfaces on the rear panel of the instrument.

1    **USB**    2



The mouse is detected automatically when it is connected. Special settings such as mouse cursor speed etc, can be made in the **Start - Control Panel - Mouse** menu of Windows XP. The menu can be accessed by pressing the **Windows** key on the external keyboard.

## Connecting an External Monitor

**Caution:**

*The monitor must be connected only when the instrument is switched off (STANDBY) to prevent damage to the monitor and the R&S SMATE.*

*Do not modify the screen driver (Display type) and the display configuration since this will impair instrument operation.*

An external monitor with an analog interface can be connected to the MONITOR connector on the rear panel of the R&S SMATE. An external monitor is a prerequisite for manual control of the instrument and for operation of Windows XP without a Remote Desktop connection to an external PC.

**Connection**

Before the external monitor is connected, the instrument must be switched off (standby mode) to prevent damage to the monitor and the R&S SMATE. After connection, the external monitor is detected when the instrument is started. The generator screen with all elements, e.g. block diagram, Winbar, etc, is then displayed on the external monitor and on the R&S SMATE. Further settings are not required.

## Connecting the R&S SMATE to a Network (LAN)

The R&S SMATE is equipped with a network interface and can be connected to an Ethernet LAN (local area network).

Provided the appropriate rights have been assigned by the network administrator and the Windows XP firewall configuration is adapted accordingly, files can be transmitted via the network, and network resources, e.g. a network folders, can be used. The instrument can also be remote-controlled and manually controlled in the network.

Manual network control means that the user can operate the R&S SMATE from any remote PC in the network via the **Remote Desktop Connection** which is provided for Windows PCs or via the **Ultr@VNC** connection which is provided for Linux/Unix and Windows PCs. For instance, the user can control one or more R&S SMATEs from a desk that is part of a test assembly located in another section of the building (see section "[Manual Remote Control via an External Controller](#)", on page 1.30).

Remote-control of the instrument via the LAN interface is described in section "[Remote Control via LAN Interface](#)", on page 5.5.

---

**Important:** *In contrast to file transfer via LAN which requires only a partial permission (exception) in the firewall, remote control via LAN is only possible if the firewall is completely switched off. Therefore, the firewall settings for remote control differ from the firewall settings for file transfer (see section "[Remote Control via LAN Interface](#)").*

---

A firmware update via the LAN interface is described in chapter 2 of the service manual (on CD-ROM).

### Connection to the Network



**Caution:**

*We recommend that connection of the instrument to the network be coordinated with the network administrator. Connection errors may affect the entire network. Connect and disconnect the network cable only when the instrument is switched off (standby). Only then can the network connection be reliably detected and impairments to instrument operation avoided.*

The instrument is connected to the LAN with the aid of a commercial RJ-45 cable suitable for a 10/100/1000Mbps connection attached to the LAN interface at the rear of the instrument.



### Configuring the R&S SMATE for Network Operation

The network interface functions with 10/100/1000Mbps Ethernet IEEE 802.3u. The TCP/IP network protocol and the associated network services are preconfigured.

For data exchange in a LAN, each connected PC or instrument must be accessible via an IP address or via an unambiguous computer name. In addition, network access of the different users is organized by the assignment of access rights.

Access rights determine which of the available network resources, e.g. data logging systems, are available to the R&S SMATE.

The Windows XP operating system is protected by an activated firewall per default. The configuration of the firewall has to be adapted according to the required network communication needs.

### Networks using DHCP

The R&S SMATE is preconfigured for networks using DHCP (dynamic host configuration protocol). In these networks, an available IP address is automatically assigned to the R&S SMATE. In this case the generator is identified via an unambiguous computer name in the network.

Each R&S SMATE is assigned a individual computer name in the factory. This name can be queried and changed in the **Start - My Computer** menu of Windows XP (see "[Query Computer Name](#)" below).

### Networks using fixed IP addresses

In networks using fixed IP addresses, the addresses are mostly assigned by the network administrator. A fixed IP address must be entered in the **Start - Control Panel** menu of Windows XP .

### Point-to-Point Connection

To build a simple network – just an LAN connection between the R&S SMATE and a controller without integration into a larger network – an IP address has to be assigned to the R&S SMATE and the controller. For such purposes, the IP addresses 192.168.xxx.yyy are available .The value range for xxx and yyy is 1...254, the value for the subnet mask is always 255.255.255.0.

For this type of connection, a commercial cross-over RJ-45 cable is used.

### User name and pass word

The user "**instrument**" is assigned to the R&S SMATE. The user name is used for auto-login when the instrument is started and for manual remote-control. The password is also "**instrument**". By assigning the respective rights, the network administrator decides which directories and resources in the network can be accessed by the R&S SMATE.

The configuration of the R&S SMATE for networking is performed in the Windows XP embedded menus. The operating system can only be accessed if an external keyboard and/or mouse and a external monitor are connected. Operation by mouse only without the external keyboard is possible if the on-screen keyboard is used. To ensure recognition of the external devices, the instrument has to be switched off prior to connecting them.

1. Switch off instrument
2. Connect external keyboard and/or mouse and external monitor to the USB interface.
3. Switch on instrument

1. Open the start menu (either by pressing the **Windows** key (on the keyboard next to the Ctrl key) or by moving the mouse to the bottom of the display and subsequent clicking on **Start**).

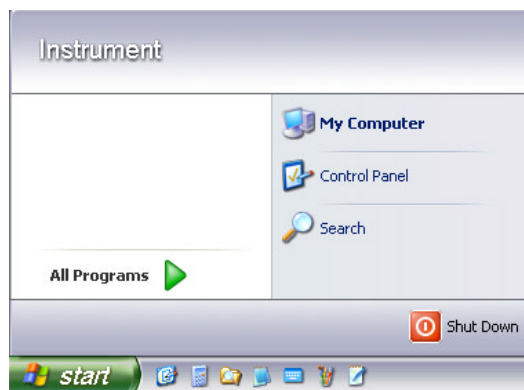

2. Click **Control Panel** and then **Network and Internet Connections**.

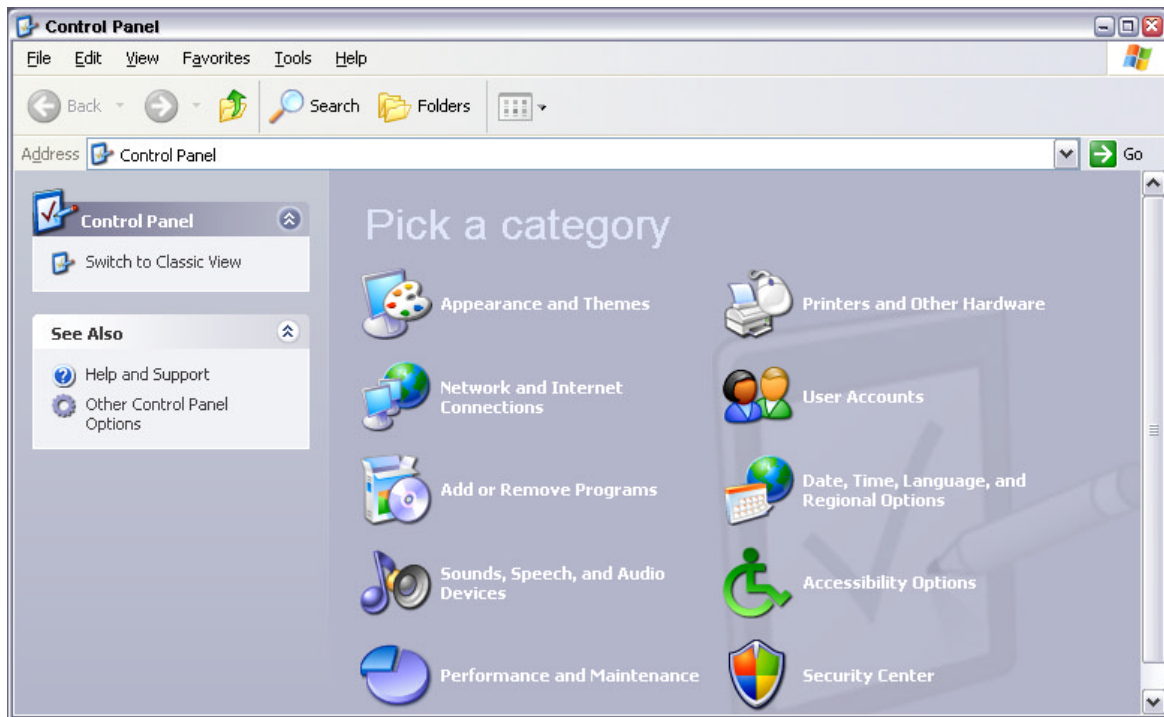

3. Click **Network Connections** at the bottom right of the **Network and Internet Connections** menu.

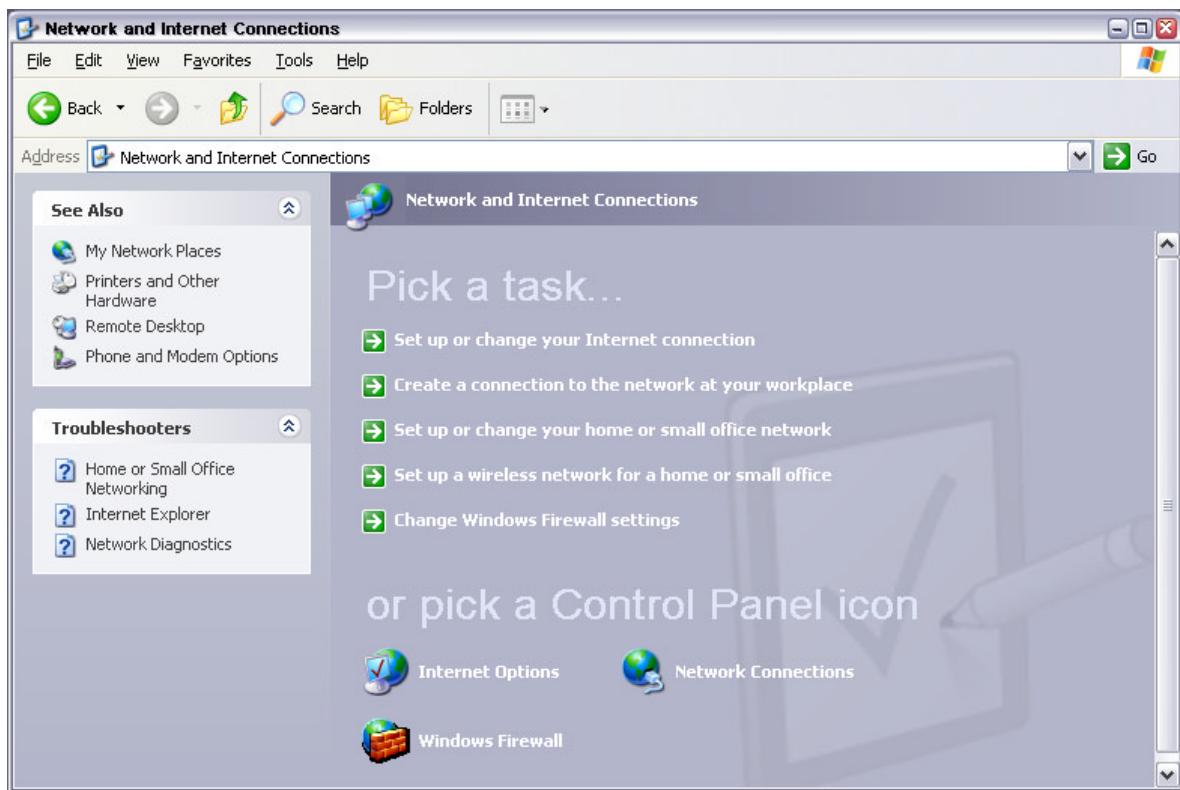



4. Click **LAN Area Connection** in the **Network Connections** menu (at the right)

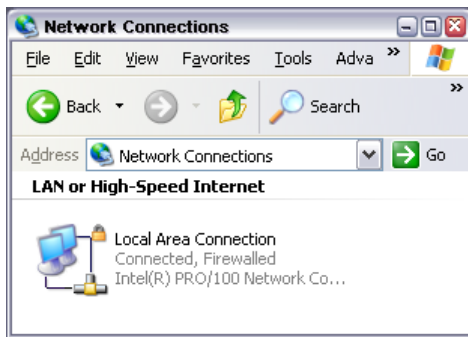

5. On the **General** tab, select **Internet Protocol (TCP/IP)** in the field **This connection uses the following items:** and then click the **Properties** button.

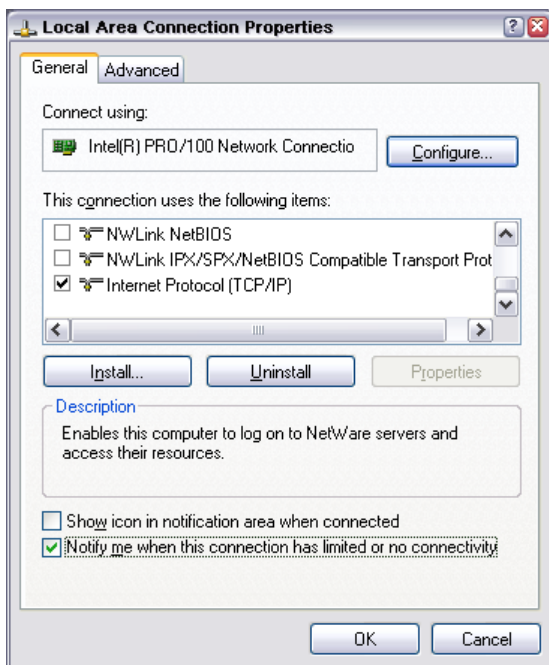

- In the **Internet Protocol (TCP/IP) Properties** menu, enter the IP address in the **Use the following IP address:** field (the complete data can be queried from the network administrator). Terminate the entry in all menus with OK.

**Obtain an IP address automatically** (DHCP = dynamic host configuration protocol) is the default setting.

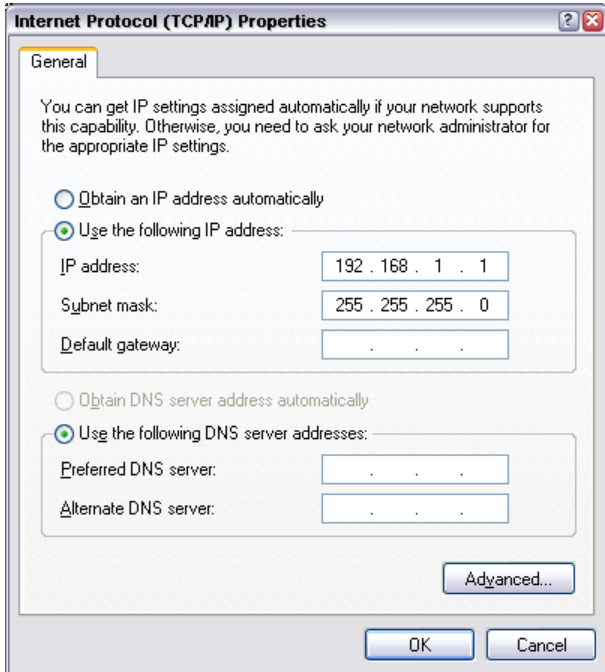

### Query Computer Name

- Open the start menu, select **My Computer** and open the context menu by pressing the right mouse key.

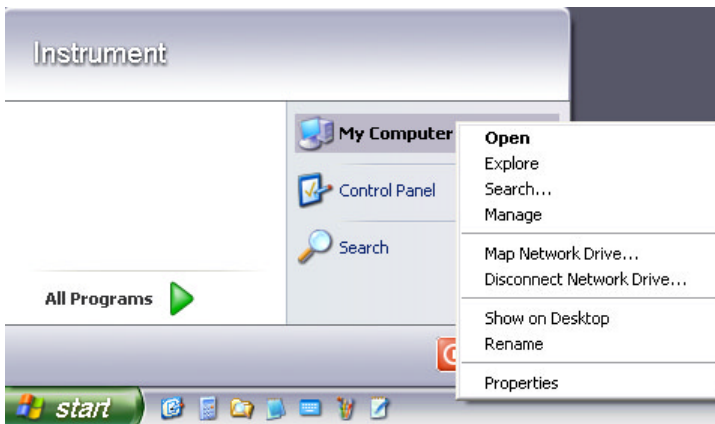

2. Click **Properties** and select the **Computer Name** tab in the menu.

The computer name is displayed under **Full Computer Name**:. The name can be changed in the **Change** submenu.

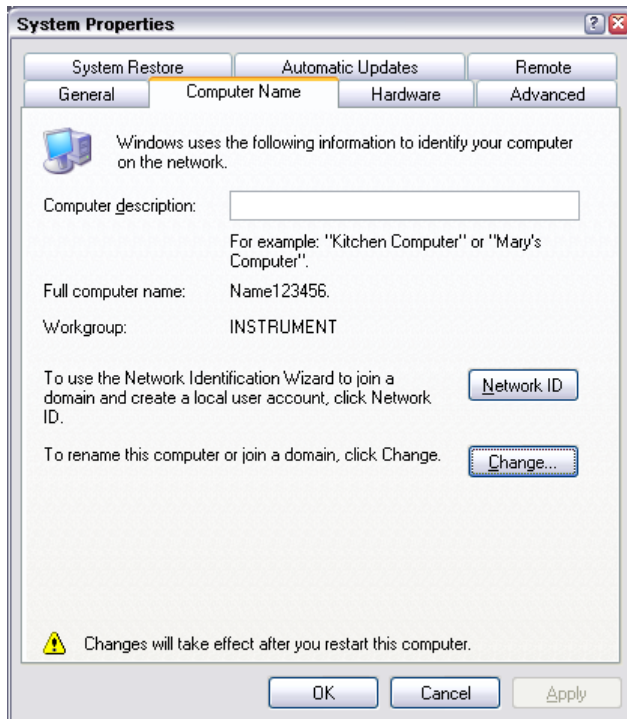

The Windows XP Firewall blocks all network communication which is not initialized by the controller itself or which is defined as unwanted. It protects the controller from an attack of hostile users and programs. On the R&S SMATE, the Internet Connection Firewall (ICF) is activated for all network connections per default to enhance protection of the instrument.

To enable data transfer with other controllers in a local network, file and printer sharing must be specifically permitted.

1. Open the start menu, select **Control Panel** and open the context menu by pressing the right mouse key.

2. Click **Switch to Classic View** and select the **Windows Firewall**.

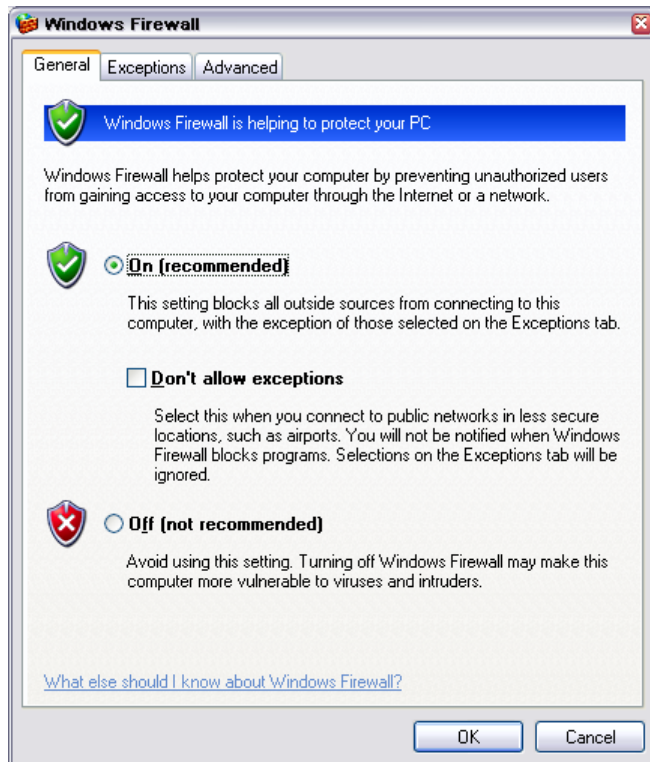

3. Select tab **Exceptions** and activate check box **File and Printer Sharing**. Confirm entry with **Ok**,

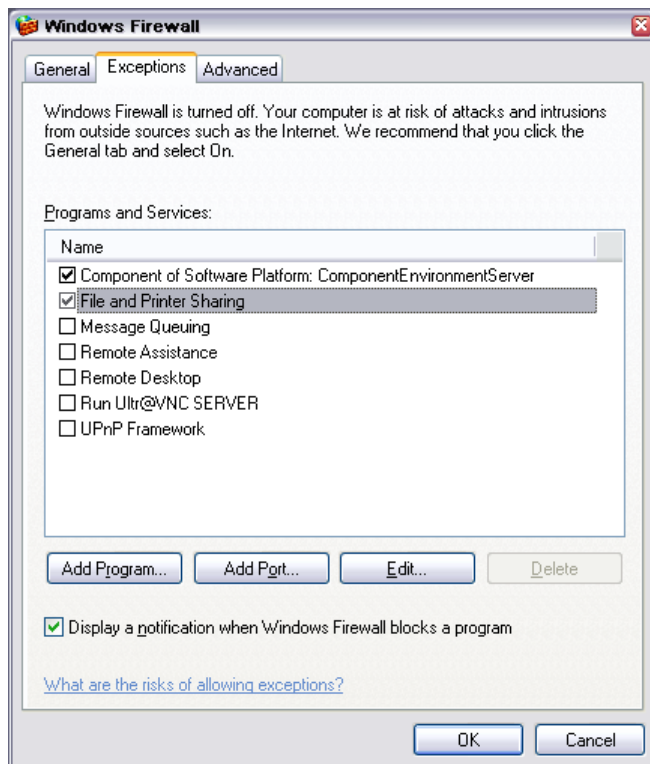

Access to network drives depends on access rights and whether the drives in question have been enabled. The complete integration of the R&S SMATE into a larger network with the necessary allocation of rights is highly complex and normally performed by a network administrator.

However, the hard disk of a computer also connected to the network can be accessed from the R&S SMATE relatively easily. The only precondition for this is that the desired directory the R&S SMATE should access is enabled on the remote computer. Subsequently, this directory is accessed from the R&S SMATE using a WindowsXP® search function.

This procedure is also of importance for a point-to-point connection, for instance in order to start a firmware update for which the files have been stored on the hard disk of the remote computer.

---

**Note:** *The computer and the signal generator must both be equipped with a computer name and an IP address (see section "[Configuring the R&S SMATE for Network Operation](#)").*

---

### Enabling the desired directory on the remote computer

---

**Note:** *The menu name may deviate from the name specified in the operating sequence, depending on the language and on the operating system used on the computer.*

---

1. On the computer, in Windows Explorer mark the directory to be enabled and open the **Properties** menu with the right-hand mouse button.
2. In the **Sharing** panel, activate the **Share this folder** checkbox.
3. Write down the name of the computer (see section "[Query Computer Name](#)").

### Accessing the enabled directory on the R&S SMATE

1. Call the Start menu.
2. In the **Search** menu, select **Computers or People** and then **A Computer on the Network**.
3. In the input window of the query **Which Computer you are looking for?**, enter the computer name and start the search by pressing the enter key.  
The computer and its name appears in the results list.
4. Click the computer's name to display the enabled directory. The files in this directory can be used in the R&S SMATE.

---

**Note:** *If a user name and password are requested when you click the computer, the login name and password used on the computer must be entered.*

---

# Manual Remote Control via an External Controller

The R&S SMATE can be manually remote-controlled from an external PC via a network link. This allows convenient operation of the vector signal generator from the desktop although the instrument is integrated in a rack in the next room.

**Manual remote control** in contrast to **remote control** does not use remote-control commands but a separate software which is installed on the external PC. After its start, the software simulates the user interface of the R&S SMATE. The instrument can thus be manually operated from the PC as on the unit itself.

A precondition for manual remote control is a connection between signal generator and PC via a LAN network and the installation of the software on the PC and on the R&S SMATE.

Two free-of-charge programs are available for setting up the connection for manual remote control: The Windows program **Remote Desktop Connection** for PCs with Window operating system and the program **Ultr@VNC** for PCs with Linux/Unix or Windows operating system.

After the connection is established, the signal generator screen with the block diagram is displayed on the external PC and the R&S SMATE can be manually remote-controlled from the external PC. The individual functions are operated using the mouse and keyboard. Specific instrument functions can be executed using specific key combinations on the keyboard (see table in Chapter 3, section "[Legend of Manual Controls](#)", on page 3.1).

Installation of the remote-control software and establishing the connection between external PC and signal generator is described in the following.

## Configuration for Manual Remote Control via Windows Remote Desktop Connection

The instrument is operated with the aid of the Windows program **Remote Desktop Connection** which is provided free-of-charge by Microsoft in the download area of the Internet (<http://www.microsoft.com>).

Manual remote control of the signal generator via RemoteDesktop is possible under the following conditions:

- The Windows 95 operating system or higher and the **Remote Desktop Connection** program are installed on the external PC and a LAN interface is configured for the network.
- The signal generator and PC are linked via a LAN.
- The **Remote Desktop Connection** is enabled on the R&S SMATE
- R&S SMATE data (IP address or computer name of R&S SMATE in the network) is entered in the **Remote Desktop Connection** program of the external PC.
- Login on the external computer for the R&S SMATE was carried out with the correct user name (instrument) and the correct password (instrument).

**Caution:**

*After activation of the remote desktop, any user on the network who knows the computer name and login data of the vector signal generator can access this R&S SMATE. Even after cutting it, the connection is still enabled and the R&S SMATE can be accessed any time. To disable the connection, the remote desktop must be deactivated on the R&S SMATE.*

## Enable Remote Desktop Connection on R&S SMATE

The configuration is performed in the Windows XP embedded menus. The operating system can only be accessed if an external keyboard and monitor is connected. A mouse is recommended for convenient operation of Windows XP. To ensure recognition of the external devices, the instrument has to be switched off prior to connecting them.

1. Switch off instrument
2. Connect external keyboard, mouse and monitor to the USB interface.
3. Switch on instrument
4. Open the start menu, select **My Computer** and open the context menu by pressing the right mouse key.

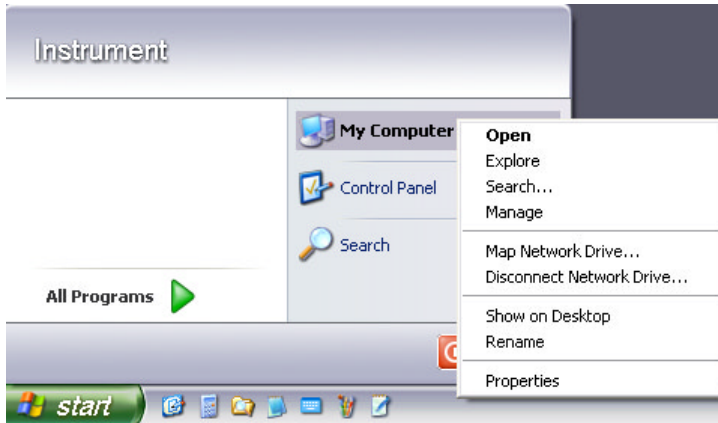

5. Click **Properties** and select the **Remote** tab in the menu.
6. Activate check box **Allow users to connect remotely to this computer** and close window with the **OK** button.

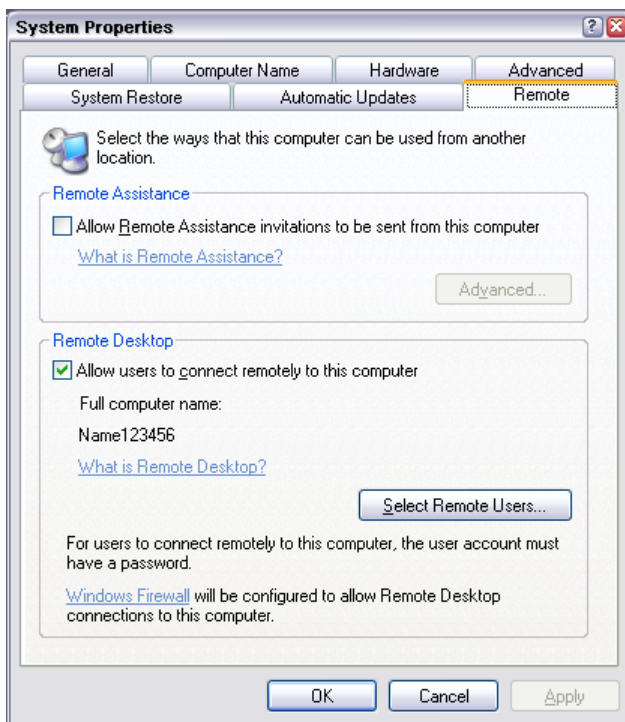

**Note:** When activating/locking the Remote Desktop, the associated firewall settings are automatically enabled/disabled.

## Install Remote Desktop and Establish Connection on the Windows PC

The **Remote Desktop Connection** program of Microsoft is available on the Internet for the Windows 95™ operating system and its successors as a free-of-charge download. Following the instructions on the Internet, it can be loaded onto any external PC. For the Windows XP operating system, the program is already preinstalled or it is available on the installation CD-ROM.

1. Install **Remote Desktop Connection** program on the PC if required.
2. Start program in the **Start - All Programs - Accessories - Communications** window.

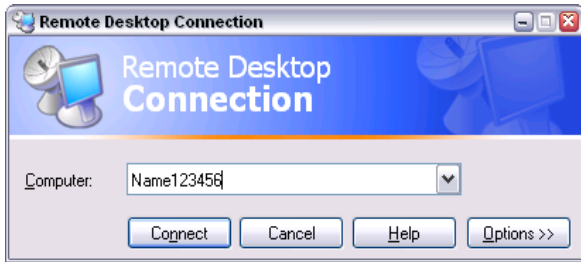

Prior to the first use, the instrument and user ID of the R&S SMATE must be entered on the external PC. The instrument ID, i.e. the computer name of the R&S SMATE, identifies the R&S SMATE in the network. Each R&S SMATE is assigned a computer name in the factory, which can be used for manual remote control. The query for the computer name is described in section "[Query Computer Name](#)".

The user name and the password is required for accessing the R&S SMATE. On the R&S SMATE "**instrument**" is preset as the user name and password. No entry need be made in the **Domain** field.

3. Enter the instrument and user name and the password of the R&S SMATE in the **General** tab of the extended menu which is opened with the **Options>>** button.

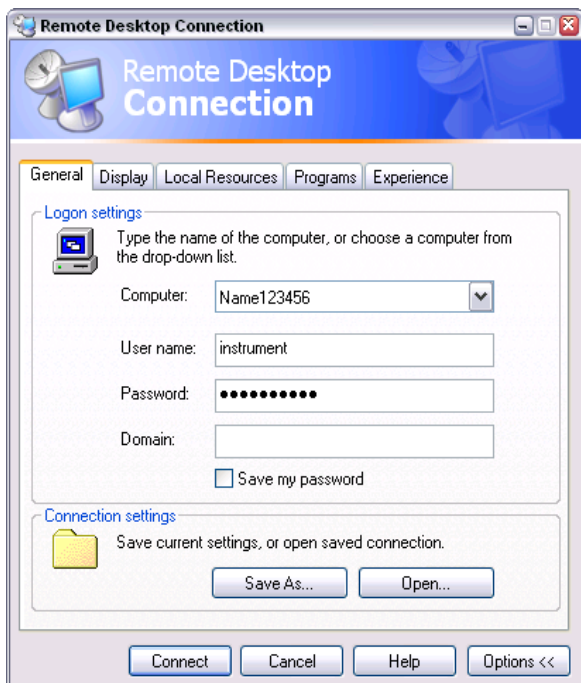



4. Login data can be stored with the **Save As** button.  
If it is stored as a **default.rdp** file, the connection to the R&S SMATE is offered as the default when the program is started. If the data is stored under another name, the R&S SMATE link is available in the selection list opened with the  button of the **Computer:** entry field.
5. Enter remote desktop size 800 x 600 in the **Display** tab.

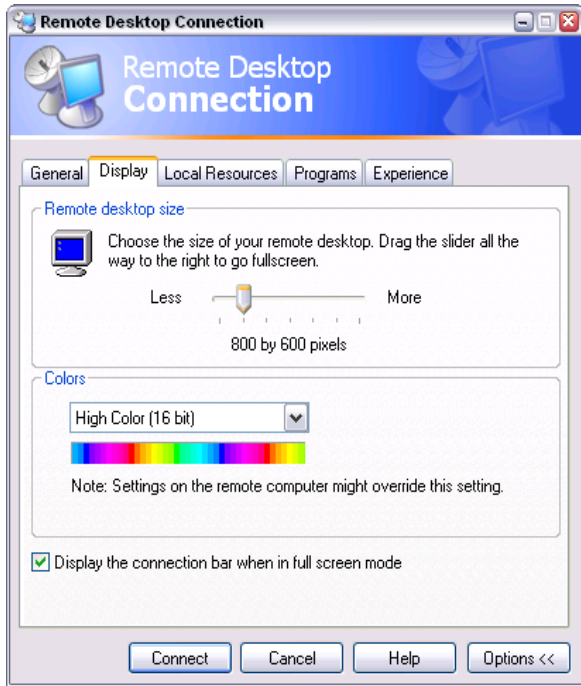

6. The connection is established when the **Connect** button is pressed.

After the connection is established, the signal generator screen with the block diagram is displayed and the R&S SMATE can be manually remote-controlled from the external PC.

The individual functions are operated using the mouse and keyboard. Specific instrument functions can be executed using specific key combinations on the keyboard (see table in Chapter 3, section "[Legend of Manual Controls](#)", on page 3.1).

The device firmware of the R&S SMATE is disabled when the connection is set up. **Direct control on the R&S SMATE is not possible while manual remote-control is active.** The access of an external PC is indicated by the logon screen of Windows XP Embedded which identifies the accessing user.

If several R&S SMATE instruments are to be manually remote-controlled from one PC, a separate **Remote Desktop Control** window must be opened for each R&S SMATE. This is possible by starting the program on the external PC several times.

## Cut Manual Remote Control Connection via Remote Desktop

The connection can be cut either on the R&S SMATE or on the external PC. Cutting the connection does not disable it. It can be established again any time.

**Cutting the connection on the signal generator** (requires external keyboard, mouse and monitor):

1. Click **Disconnect** in the remote-control message menu of the R&S SMATE

The connection is cut, a message on the external PC informs about the disconnection.

**Cutting the connection on the external PC:**

1. Open the start menu.
2. Click **Disconnect** in the lower right-hand corner of menu

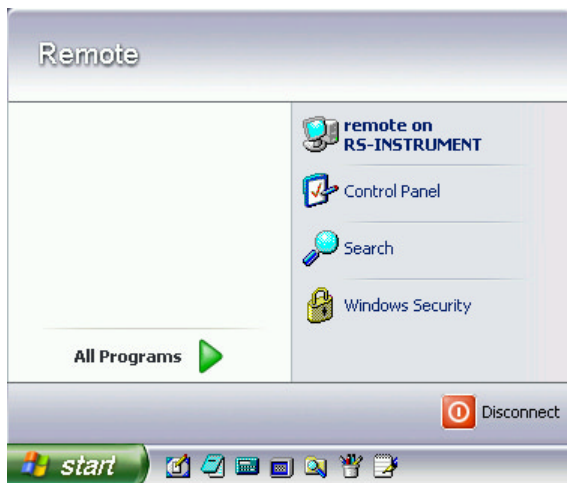

## Disable Manual Remote Control Connection via Remote Desktop

The connection can be disabled by deactivating the Remote Desktop on the R&S SMATE .

1. Open the start menu with the **Windows** key, select **My Computer** and open the context menu by pressing the right mouse key.
2. Click **Properties** and select the **Remote** tab in the menu.
3. Deactivate check box **Allow users to connect remotely to this computer** and close window with the **OK** button.

The connection is disabled, it is no longer possible to access the R&S SMATE for manual remote control via **Remote Desktop**..

## Configuration for Manual Remote Control via Ultr@VNC

The instrument is operated with the aid of the program **Ultr@VNC**. The program is included in operating system Linux/Unix. It is available as a free-of-charge download on the internet for operating system Window XP (<http://ultravnc.sourceforge.net/download.htm>)

Manual remote control of the signal generator is possible under the following conditions:

- The external PC with Linux/Unix or Windows operating system (Windows 95 or higher) is equipped with a LAN interface which is configured for the network.
- The signal generator and PC are linked via a LAN.
- The **Ultr@VNC** program is installed and enabled on the R&S SMATE, and an user-specific password for the **VNC** connection is defined. Communication on the network via **Ultr@VNC** program is enabled in the firewall.
- PC with Linux/Unix operating system  
R&S SMATE IP address is entered in the **address line** of the internet browser of the external PC and the user-specific password for the **VNC** connection is entered in the request panel.
- PC with Windows operating system  
The **Ultr@VNC Viewer** program component is installed on the external PC  
R&S SMATE IP address and the user-specific password for the **VNC** connection are entered in the **VNC Viewer** panel.



**Caution:**

*After enabling the VNC connection, any user on the network who knows the password and IP address of the vector signal generator can access this R&S SMATE. Even after cutting it, the connection is still enabled and the R&S SMATE can be accessed any time. To disable the connection, the VNC program on the R&S SMATE must be deinstalled or the VNC server service disabled.*

*To enhance security, also communication on the network via Ultr@VNC program should be disabled in the firewall.*

## Install and Enable VNC Connection on R&S SMATE

The **Ultr@VNC** program is available on the Internet as a free-of-charge download. Following the instructions on the Internet, it can be copied onto the R&S SMATE.

1. Download the program from the internet and copy it to a directory that can be accessed by the R&S SMATE.
2. Switch off instrument.
3. Connect a mouse, a keyboard and an external monitor.
4. Switch on instrument.
5. Shut down firmware using the ALT-F4 key combination.
6. Start installation by double clicking the setup file (Ultr@VNC\_100\_RC18\_setup.exe / whereas 18 denotes the version number).

The setup wizard leads through the installation. In the following only those panels are described in which defined settings are required for the signal generator.

- Select installation of all components

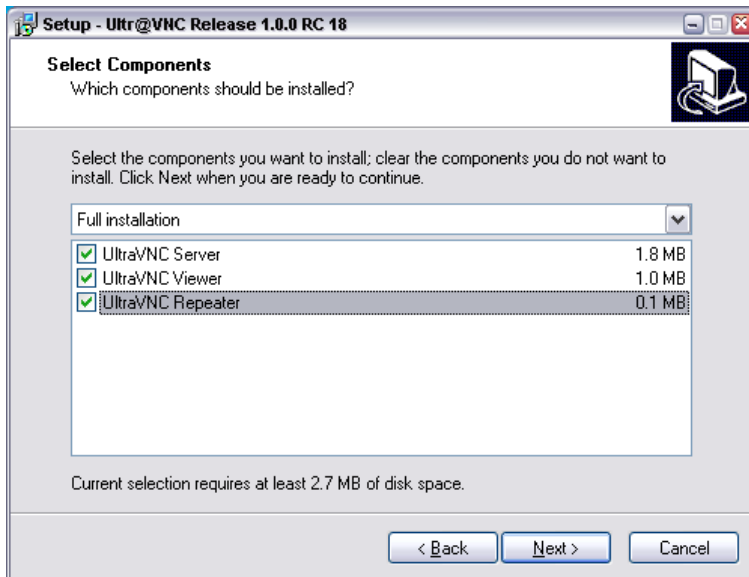

- Select all entries in the **Additional Task Panel**

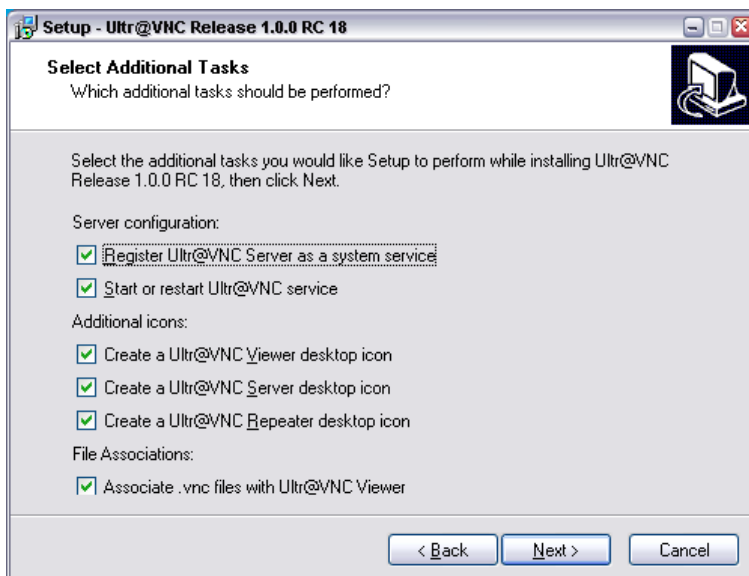

- A successful installation is indicated by a message

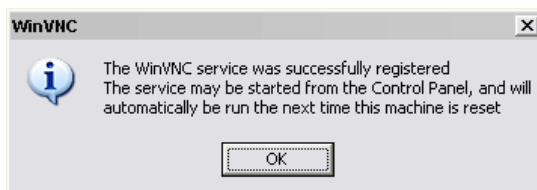

- At the same time a warning is displayed stating that a password must be set.



- After clicking **OK** in the warning panel the **Default Local System Properties** panel opens. A password with a length of at least five digits must be entered. This password is used on the remote PC to access the R&S SMATE. Other settings may be changed according to the user-specific security requirements.

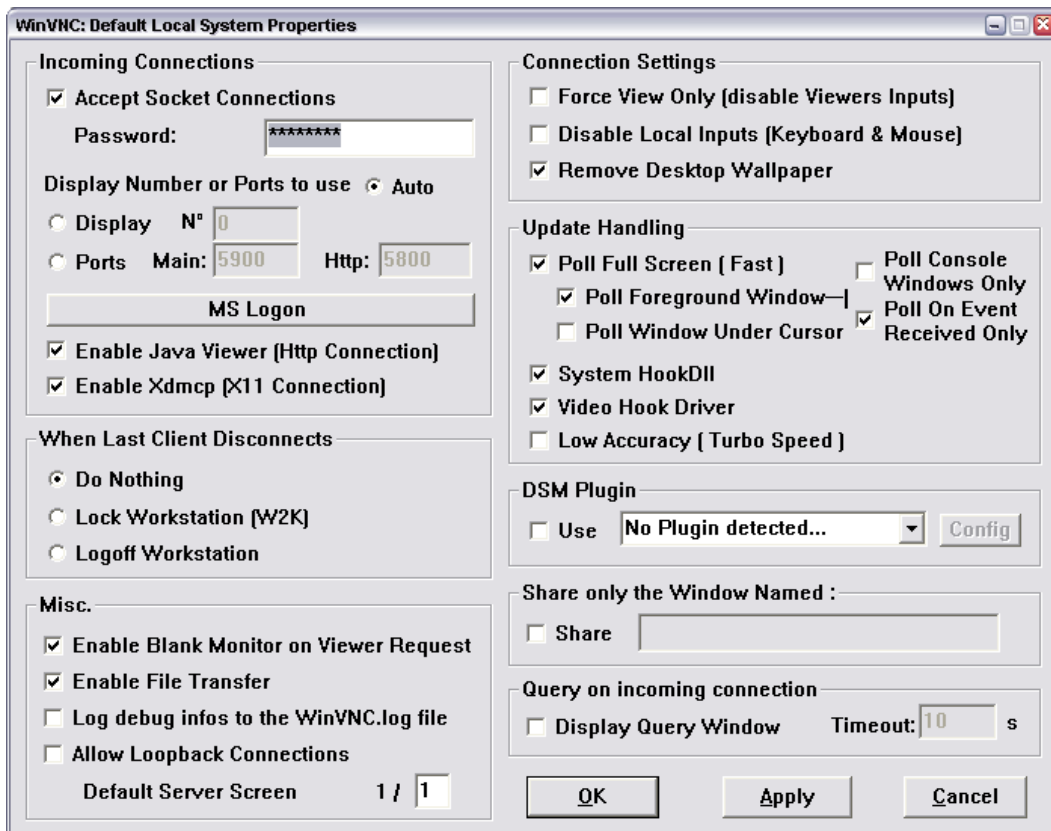

7. After the installation the VNC connection must be enabled in the ICF firewall (see following section).

After the installation the program always is automatically started together with the operating system. An icon  is placed on the right side of the Windows XP task bar (notification area). On mouse over, the IP address of the R&S SMATE is indicated. This IP address and the user-defined password are the prerequisites to enable manual remote control on the PC. A cut connection is indicated by changed color of the icon. Cutting the connection does not disable it. It can be established again any time.



## Configuring Internet Connection Firewall for VNC Connection

To enable manual remote control by other controllers in a local network via VNC connection, the connection must be specifically permitted in the firewall.

1. Open the start menu, select **Control Panel** and open the context menu by pressing the right mouse key.
2. Click **Switch to Classic View** and select the **Windows Firewall**.

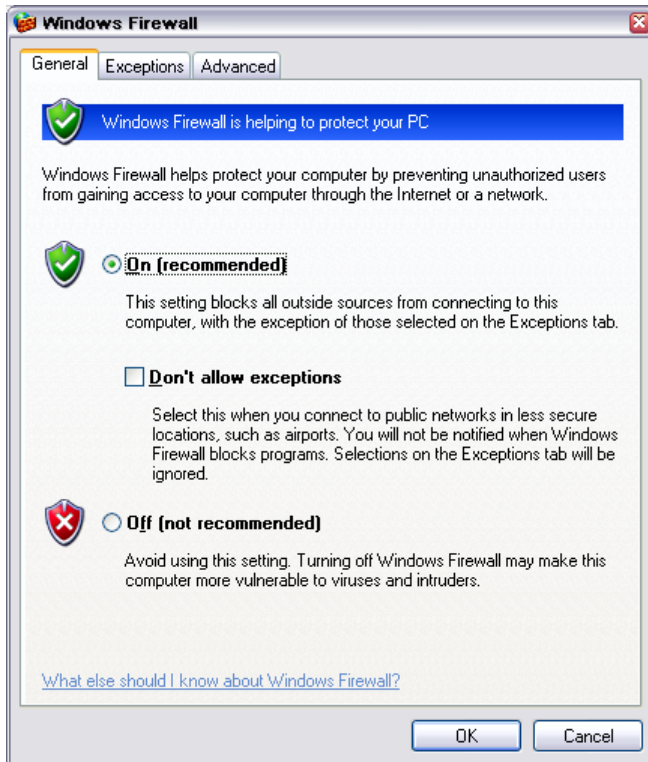

3. Select tab **Exceptions** and call sub menu **Add Program...**

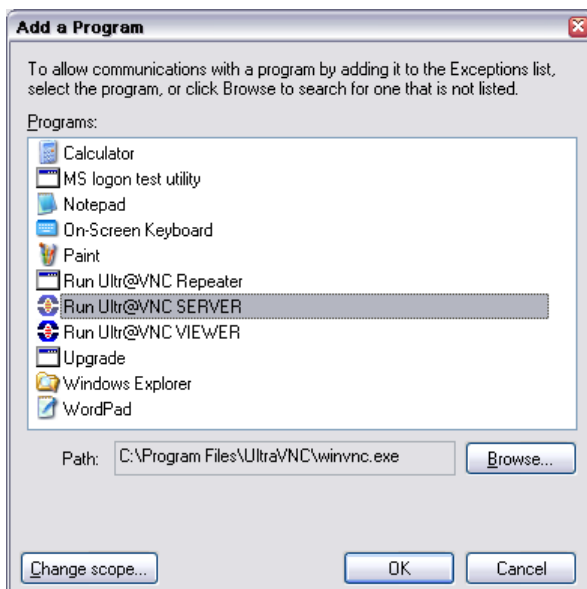

4. Select **Run Ultr@VNC SERVER** and click **Ok**.
5. Activate check box **Run Ultr@VNC SERVER** in the **Exception** tab and click **Ok**.

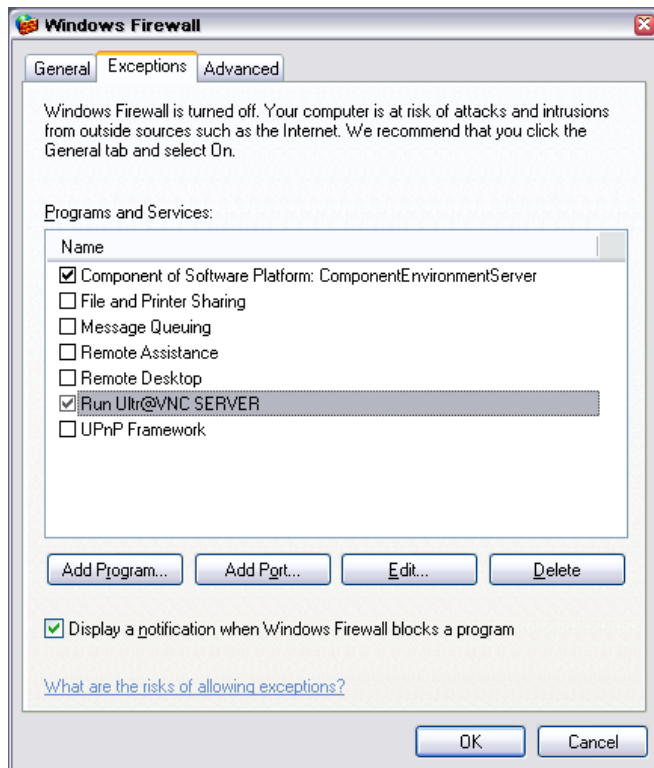

## Establish Manual Remote Control on the Linux/Unix PC

The **VNC** program is available per default for Linux/Unix operating systems. Only three steps are necessary to establish the connection to the R&S SMATE:

1. Start the internet browser on the PC.
2. Enter the following address:  

```
vnc://IP-address of R&S SMATE", e.g. vnc://192.168.1.1
```

 After Enter, the password for the remote **VNC** connection is requested
3. Enter the password defined in the **Default Local System Properties** panel of the **Ultr@VNC** program of R&S SMATE. The connection is established when the **Log On** button is pressed.

After the connection is established, the current signal generator screen with the block diagram is displayed and the R&S SMATE can be manually remote-controlled from the external PC. The individual functions are operated using the mouse and keyboard. Specific instrument functions can be executed using specific key combinations on the keyboard (see table in Chapter 3, section "[Legend of Manual Controls](#)", on page 3.1). In contrast to Remote Control Desktop, **direct control on the R&S SMATE is possible while manual remote-control is established**, it can be performed alternately with the manual remote control.

## Install VNC Viewer and Establish VNC Connection on the Windows PC

The **Ultr@VNC** program is available on the Internet as a free-of-charge download. Following the instructions on the Internet, the program can be copied onto the external Windows PC. Only the program component **VNC Viewer** is required.

**Note:** The **VNC Viewer** program is included in the download for the installation of the **Ultr@VNC** program on your signal generator if **Full installation** was selected in the **Select Component** panel. In this case, the program `ultr@vncviewer.exe` can be copied to your Windows PC.

1. Install **VNC Viewer** program component on the PC.
2. Start **VNC Viewer** program component on the PC.

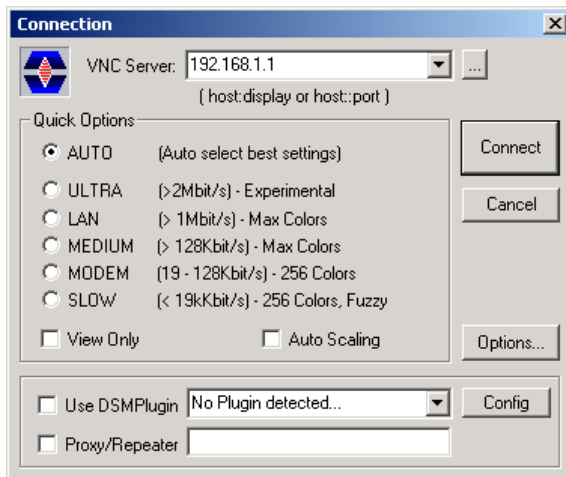

3. Enter IP address of R&S SMATE in input line **VNC Server**.
4. Initialize the connection by pressing the **Connect** button.

A message requesting the password appears.



5. Enter the **VNC** password defined in the **Default Local System Properties** panel of the **Ultr@VNC** program of R&S SMATE. The connection is established when the **Log On** button is pressed.

After the connection is established, the current signal generator screen with the block diagram is displayed and the R&S SMATE can be manually remote-controlled from the external PC. The individual functions are operated using the mouse and keyboard. Specific instrument functions can be executed using specific key combinations on the keyboard (see table in Chapter 3, section "[Legend of Manual Controls](#)", on page 3.1). In contrast to Remote Control Desktop, **direct control on the R&S SMATE is possible while manual remote-control is established**, it can be performed alternately with the manual remote control.



## Cut Manual Remote Control Connection via Ultr@VNC

The connection can be cut either on the R&S SMATE or on the external PC. Cutting the connection does not disable it. It can be established again any time.

**Cutting the connection on the signal generator** (requires external keyboard, mouse and monitor):

1. Open the start menu with the **Windows** key or the CTRL+EXC key combination.
2. Right-click on the **VNC** icon on the task bar. The context menu opens.
3. Select **Kill all clients**

The connection is cut, a message on the external PC informs about the disconnection. The **VNC** icon  changes color.

**Cutting the connection on the external Linux/Unix PC:**

1. Either close the internet browser or close the signal generator window

The connection is disabled, the **VNC** icon on the task bar  off the R&S SMATE changes color.

**Cutting the connection on the external Windows PC:**

1. Close the **VNC Viewer** programm

The connection is cut, the **VNC** icon on the task bar  off the R&S SMATE changes color.

## Disable Manual Remote Control Connection via Ultr@VNC

The connection can be disabled by removing the program on the R&S SMATE or by deactivating the VNC Server service in the Control Panel.

**Removing the VNC program:**

1. Open the start menu with the **Windows** key or the CTRL+EXC key combination.
2. Open the **Control Panel** menu
3. Select **Add or Remove Programs**
4. Remove the **VNC** program.

The connection is disabled, the **VNC** icon on the task bar  of the R&S SMATE disappears.

**Deactivating the VNC Server service:**

1. Open the start menu with the **Windows** key or the CTRL+EXC key combination.
2. Open the Control Panel menu
3. Select **Services**
4. Deactivate the **VNC Server** service.

The connection is disabled, the **VNC** icon on the task bar  of the R&S SMATE disappears.

## Using Norton Antivirus

Virus-protection software Symantec Norton Antivirus 2005 has been successfully tested for compatibility with the measurement instrument software on R&S SMATE. However, Norton Antivirus may affect the behaviour of the instrument in terms of settling time or stability. Norton Antivirus 2005 has been subjected to detailed tests with R&S SMATE Firmware version V1.40 and the paging file settings given below. The system remains very reliable. However, rare impact on the settling time has been experienced (slight degradations of settling time in 2% of samples out of specification).

## Preparing the Installation of Norton Antivirus

The installation is performed in the Windows XP embedded operating system. The operating system can only be accessed if an external keyboard and/or a mouse is connected. Operation by mouse only without the external keyboard is possible if the on-screen keyboard is used. To ensure recognition of the external devices, the instrument has to be switched off prior to connecting them.

1. Switch off instrument
2. Connect external keyboard and/or mouse to the USB interface.
3. Switch on instrument
4. Open the start menu (either by pressing the **Windows** key (on the keyboard next to the Ctrl key) or by moving the mouse to the bottom of the display and subsequent clicking on **Start**).
5. Click **Control Panel** and then **System**.

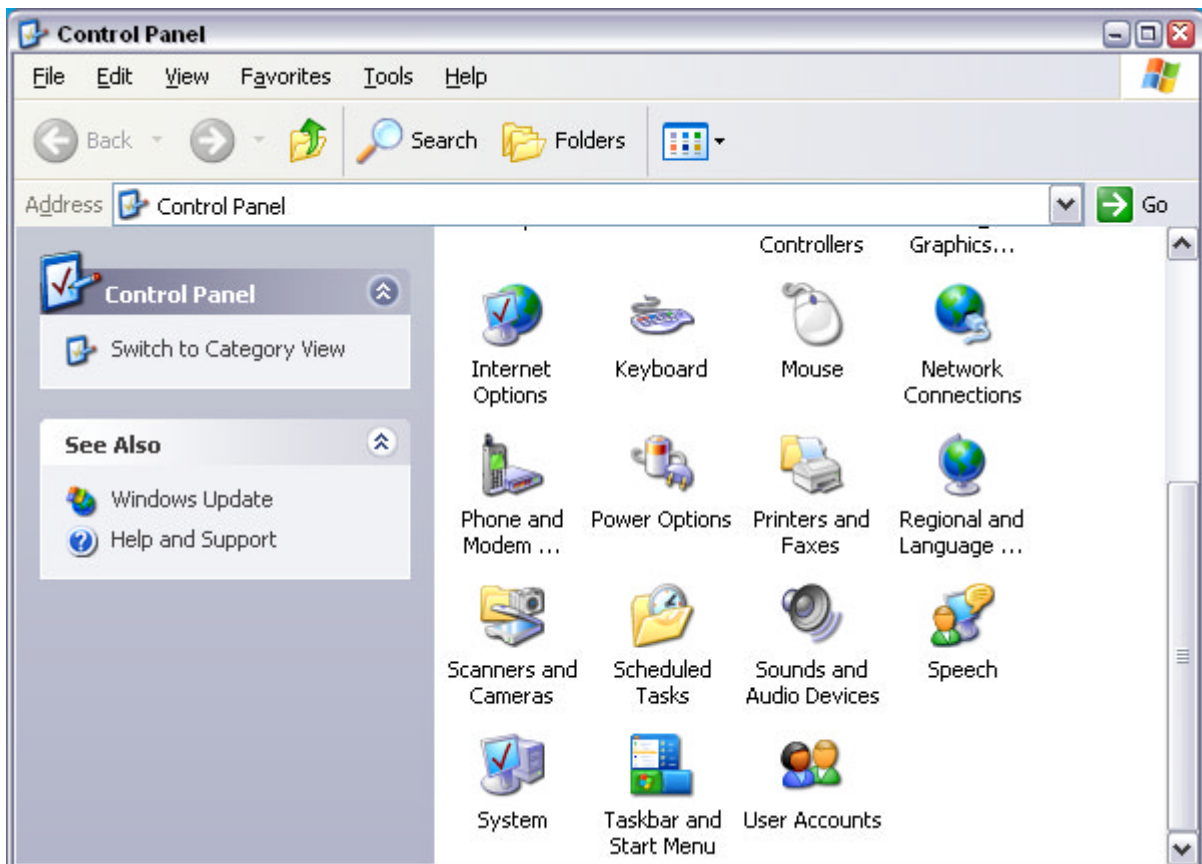

6. Select the **Advanced** and click **Performance Settings**

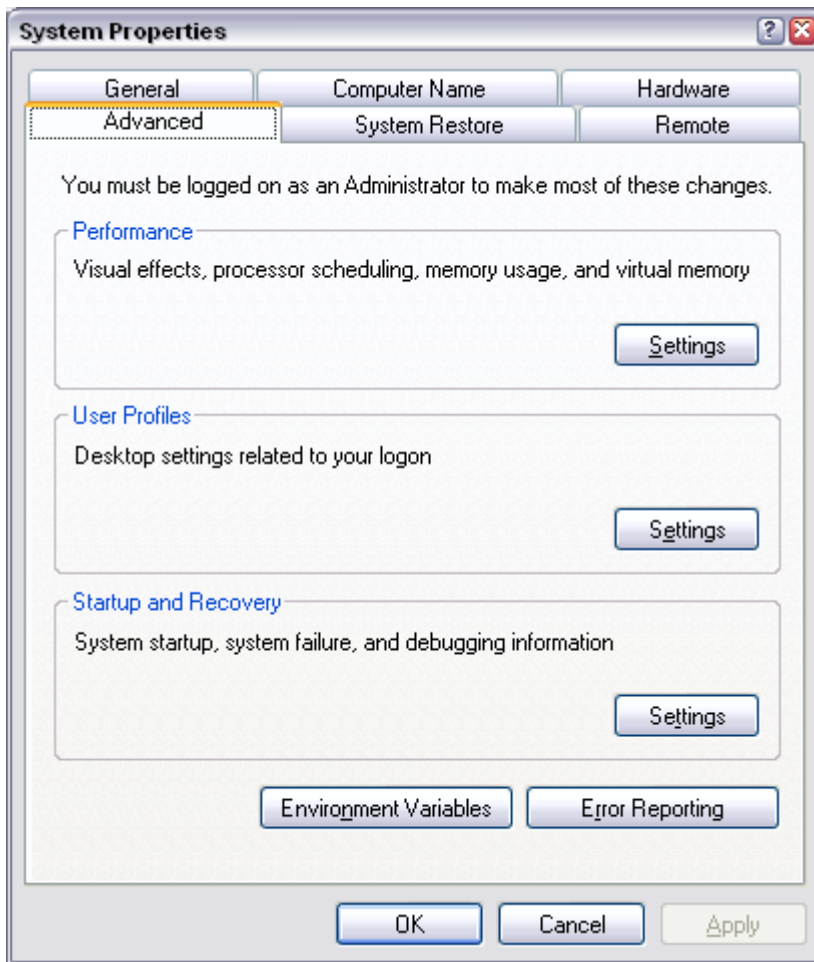

7. Click the Change button

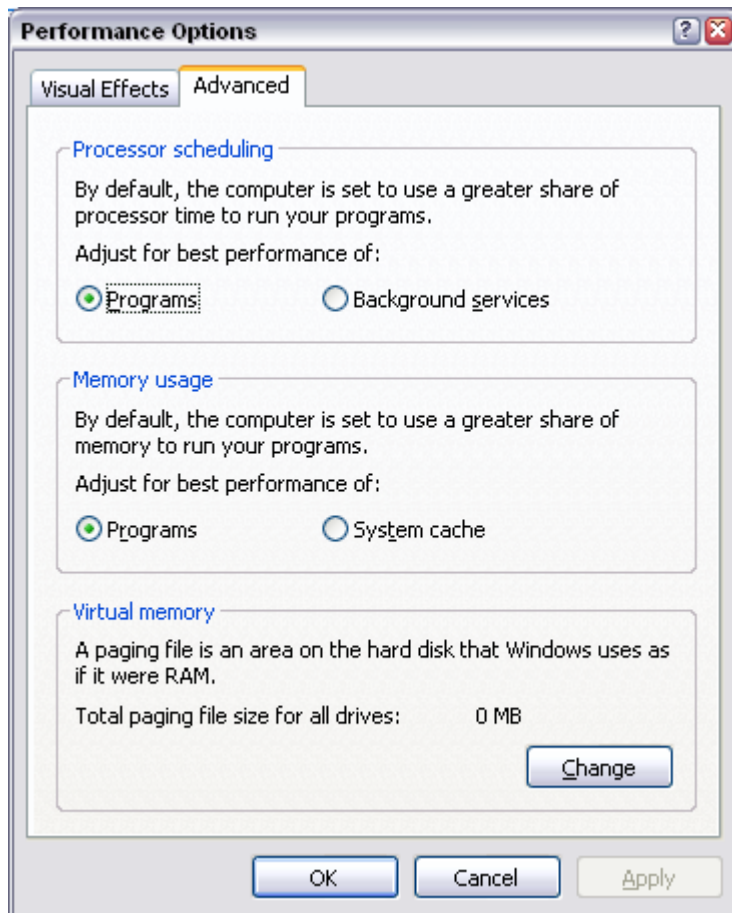

8. Activate
  - Drive D: [DATA]
  - System managed size

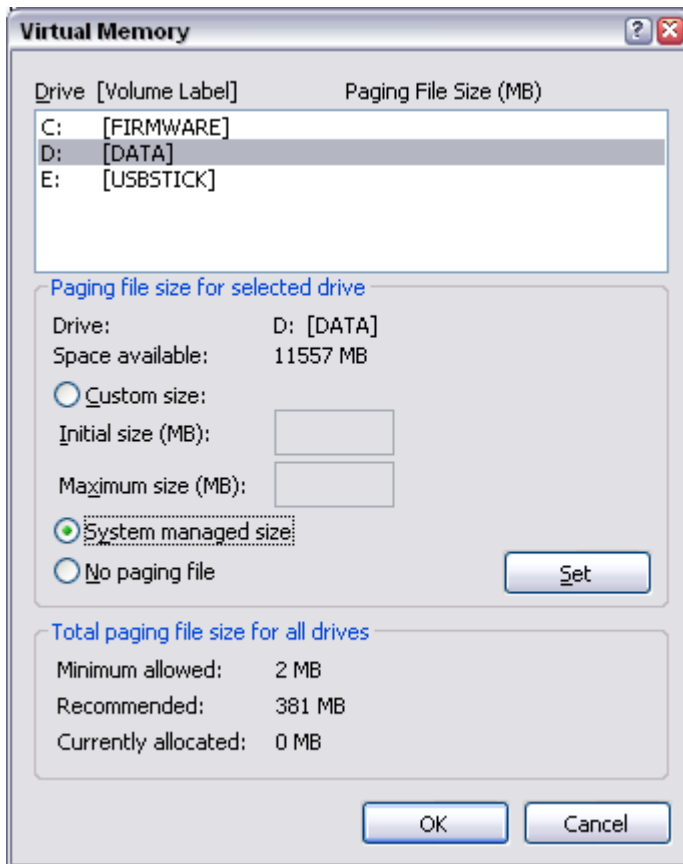

9. Click the **Set** button
  10. Click the **Close** button, the dialog closes
- Now program Norton Antivirus can be installed



## Contents - Chapter 2 "Getting Started"

<b>2 Getting Started .....</b>	<b>2.1</b>
Introduction - Getting Started .....	2.1
Baseband Section of R&S SMATE .....	2.3
RF Section of R&S SMATE .....	2.4
Applications of the Two-Path R&S SMATE.....	2.5
Two Baseband Generators, One RF Path .....	2.5
One Baseband Path and Two RF Paths .....	2.6
Fully Equipped Two-Path Instrument .....	2.7
Description of Individual Diagram Blocks .....	2.7
Available Blocks .....	2.7
Blocks of the Baseband Section.....	2.8
Blocks of the RF Section .....	2.9
Example of Setup .....	2.11





# 2 Getting Started

## Introduction - Getting Started

The main field of application of the R&S SMATE is the generation of digitally modulated signals. The R&S SMATE uses I/Q (vector) modulation. Digital data streams are converted to an I/Q baseband signal. The baseband signal is then D/A-converted and modulated onto the desired RF carrier frequency with the aid of an I/Q modulator.

The R&S SMATE provides an entirely digital baseband section for generating I/Q signals and an RF section with I/Q modulator. Baseband section and RF section may contain two paths, the first being called path A and the second path B in the description below.

**Note:** *The R&S SMATE is primarily intended to be remote-controlled via the GPIB interface or a LAN connection. Alternatively it is possible to control the instrument manually using an external monitor in combination with a mouse and keyboard or by accessing the instrument via the remote control desktop of an external PC. In the following, the indications of the user interface on the external monitor are used to explain the functions of the vector signal generator.*

The architecture of the R&S SMATE and the signal flow can be displayed in a block diagram on an external monitor connected to the R&S SMATE. In the diagram, signal processing is performed from left to right (left: baseband signal generation, extreme right: RF output). The block diagram in the figure below shows a fully equipped two-path R&S SMATE.

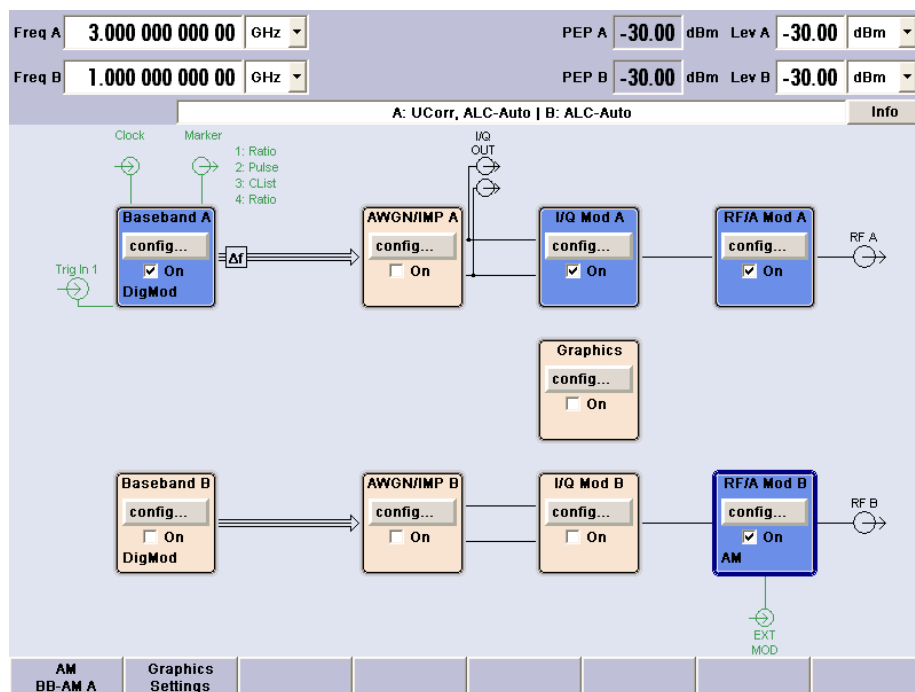

Fig. 2-1 Block diagram of a fully equipped two-path R&S SMATE

In the R&S SMATE, a digitally modulated signal can be generated in two ways:

1. The I/Q signal is generated internally in the R&S SMATE. In this case the instrument must be equipped with at least one baseband generator (option R&S SMATE-B10/B11) and at least one baseband main module (option R&S SMATE-B13). One or two baseband generators can be installed. The signals produced by the two generators can be added (possibly with frequency offset).

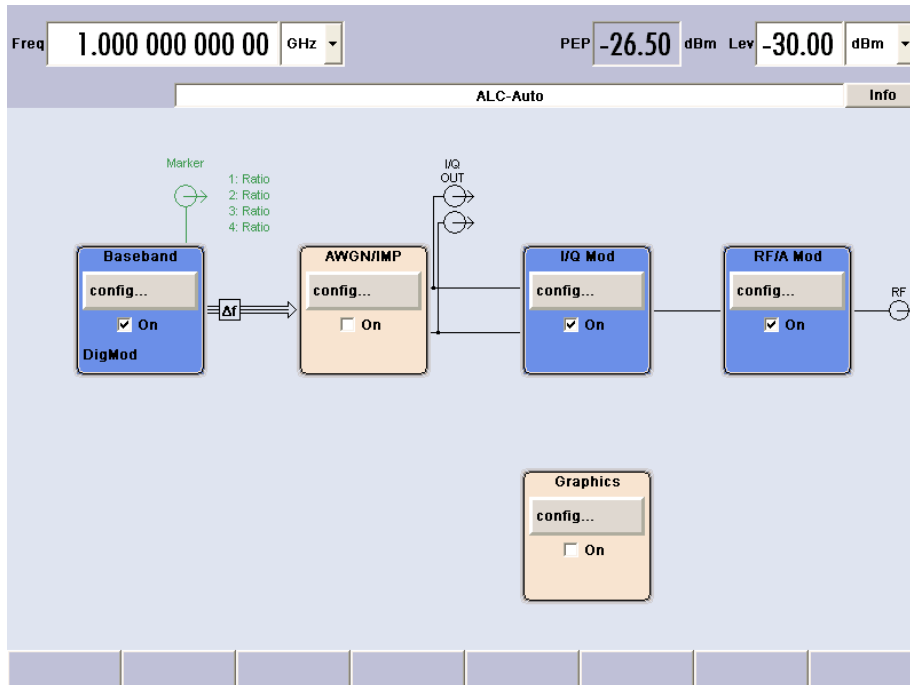

Fig. 2-2 Operation of R&S SMATE I/Q modulator with I/Q signals from the internal baseband section

2. An external analog I/Q signal is directly applied to the I/Q modulator of the R&S SMATE (Analog Wideband I/Q operation). In this mode, the entire bandwidth of the I/Q modulator can be utilized. The capabilities of the baseband section (AWGN, addition of signals, etc) are disabled, however.

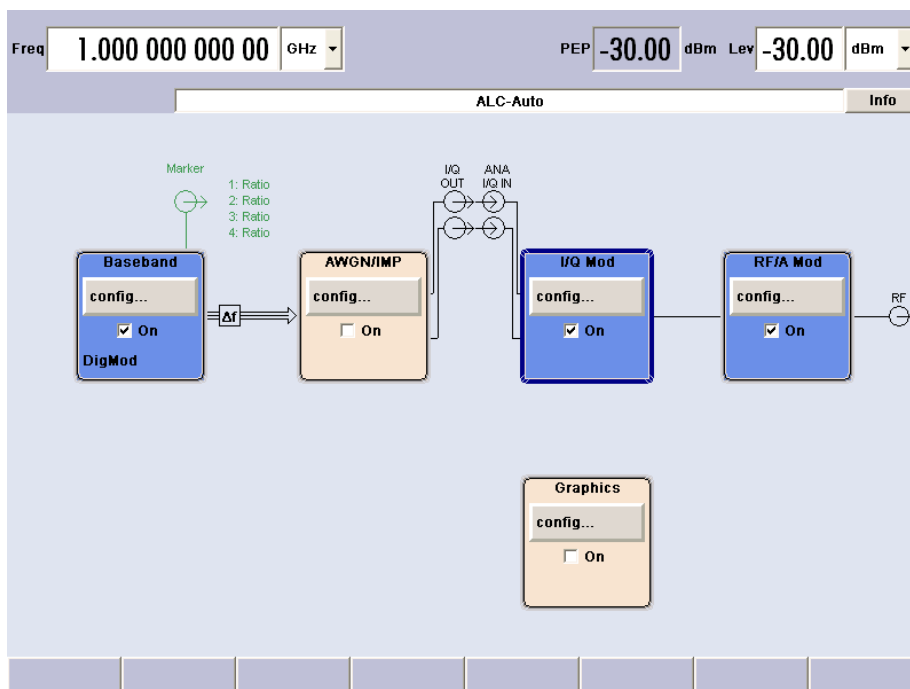

Fig. 2-3 Operation of R&S SMATE I/Q modulator with external analog I/Q signals

## Baseband Section of R&S SMATE

The baseband section of the R&S SMATE is fully digital and contains the hardware for generating and processing I/Q signals. The baseband section may contain two paths.

**Baseband generator (option R&S SMATE-B10/B11):** The generator produces baseband signals. It contains modules for real time signal generation and an arbitrary waveform generator (ARB). R&S SMATE-B10 features a much larger ARB memory size than R&S SMATE-B11 (see data sheet). But apart from the memory size, both options have the same functionality and are installed alternatively. One or two baseband generators can be fitted in an R&S SMATE and operated separately. Signals from the baseband generators can be routed from path A to B and vice versa, and added (possibly with frequency offset). Option R&S SMATE-B10/B11 contains real time Custom Digital Modulation and ARB. Software options providing various digital standards are offered in addition. Option R&S SMATE-K40, for instance, generates signals to GSM/EDGE standard, option R&S SMATE-K42 signals to 3GPP FDD standard. For more detailed information on available options, refer to the R&S SMATE data sheet and the R&S SMATE Configuration guide (available at R&S SMATE homepage on the internet).

---

**Note:** *If two baseband generators are fitted and two signals of the same standard (e.g. GSM/EDGE) are to be output simultaneously, two appropriate software options must be installed (in this case R&S SMATE-K40). If only one R&S SMATE-K40 is installed and GSM/EDGE is selected in the first baseband generator, the second baseband generator is disabled for GSM/EDGE. However, a software option is not tied to a specific baseband generator. In our example, **either** the first **or** the second baseband generator can output a GSM/EDGE signal.*

---

**Baseband main module (option R&S SMATE-B13):** This module can be installed twice (for path A and B). It is at the end of the baseband path and converts the digital signal to an analog I/Q signal. The analog I/Q signal is fed to the I/Q modulator of the corresponding RF path. The baseband main module (A or B) also routes signals to the analog I/Q outputs. This module is absolutely required for coupling out the baseband signal from the baseband section. At this stage routing from A to B or vice versa is no longer possible. If a two-path RF section is available, two baseband main modules are required if the signals from the baseband section are to be output to the two RF paths.

The baseband main module also offers digital I/Q impairment functions. The I/Q signal can be deliberately corrupted, e.g. for testing the receiver quality.

**Additional White Gaussian Noise (option R&S SMATE-K62):** Additive white noise, which may be required for instance for measurements on mobile radio base stations, can be produced with the AWGN software option (R&S SMATE-K62).

## **RF Section of R&S SMATE**

The RF section of the R&S SMATE may also contain two paths. An RF path is configured by installing a frequency option that comprises all required modules including synthesizer, output section with I/Q modulator and attenuator. One of the following options must be installed for path A:

R&S SMATE-B103	100 kHz to 3 GHz
R&S SMATE-B106	100 kHz to 6 GHz

The following frequency options are available for path B:

R&S SMATE-B203	100 kHz to 3 GHz
R&S SMATE-B206	100 kHz to 6 GHz

In addition, each RF path can be equipped with a high-power option (R&S SMATE-B31/B36) for higher output levels and with option FM/PhiM Modulator and Low Phase Noise (option SMATE-B22).

For more detailed information on options, refer to the R&S SMATE data sheet and the R&S SMATE Configuration Guide (available on the R&S SMATE Homepage on the Internet).

## Applications of the Two-Path R&S SMATE

The modular design of the R&S SMATE allows the instrument to be equipped with two paths. This allows a multitude of applications to be performed for which several signal generators were previously required. A few examples are given below.

### Two Baseband Generators, One RF Path

Possible applications:

- Addition of real time signals of different standards, e.g. GSM/EDGE and 3GPP FDD
- Generation of multicarrier signals with real time components
- Simulation of antenna diversity

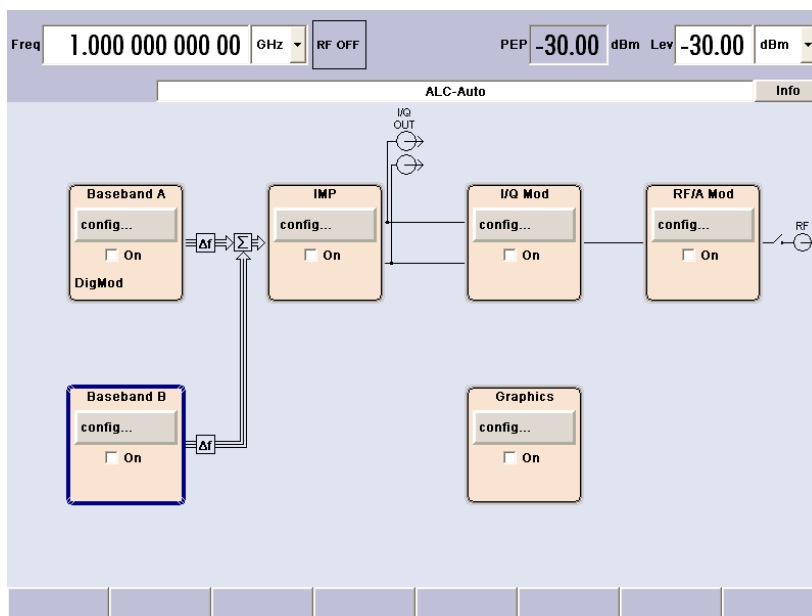

Fig. 2-4 Operation of R&S SMATE with two baseband generators and one RF path

## One Baseband Path and Two RF Paths

Possible applications:

- Generation of a modulated signal on path A and a CW interferer on path B

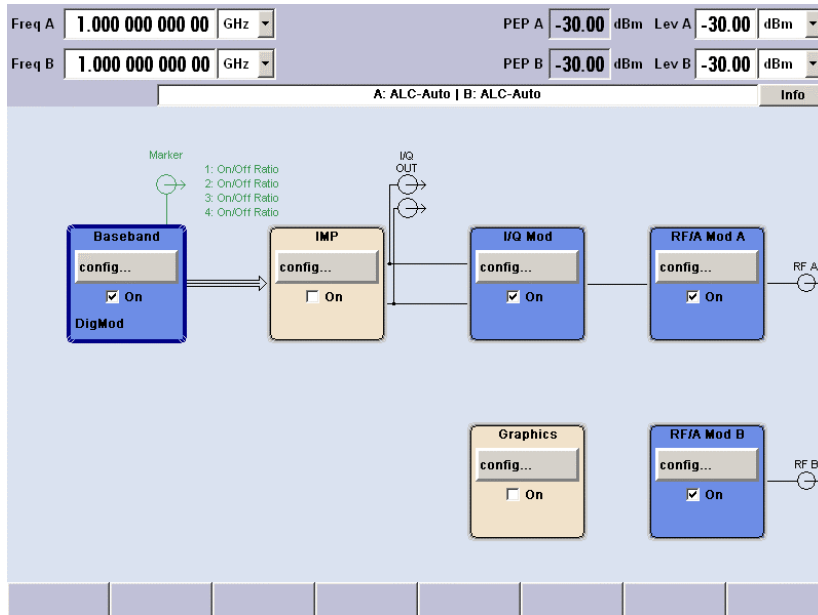

Fig. 2-5 Operation of R&S SMATE with one baseband generator and two RF paths

## Two RF Paths

Possible applications:

- Combination of an external ARB signals on path A and a CW local signal on path B
- Combination of two external ARB signals, one on path A and one on path B

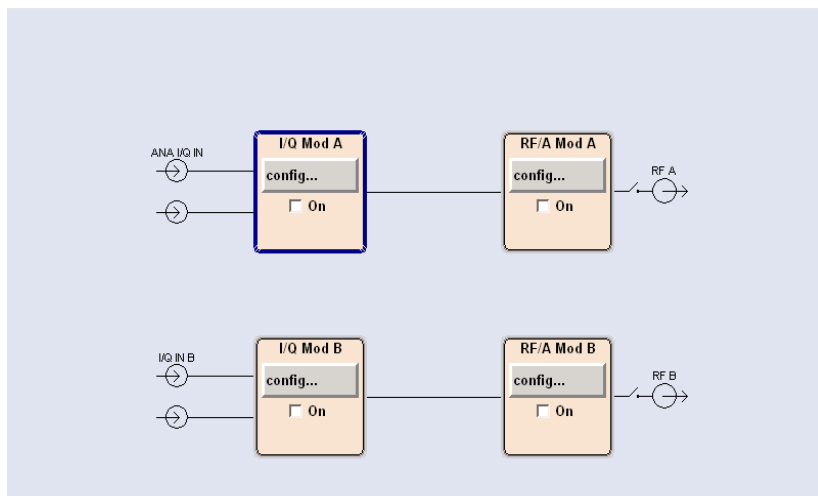

Fig. 2-5 Operation of R&S SMATE with two RF paths

## Fully Equipped Two-Path Instrument

Possible applications:

- Generation of a wanted signal and an interfering signal for receiver tests
- Generation of multicarrier signals with extremely wide bandwidth (>80 MHz)

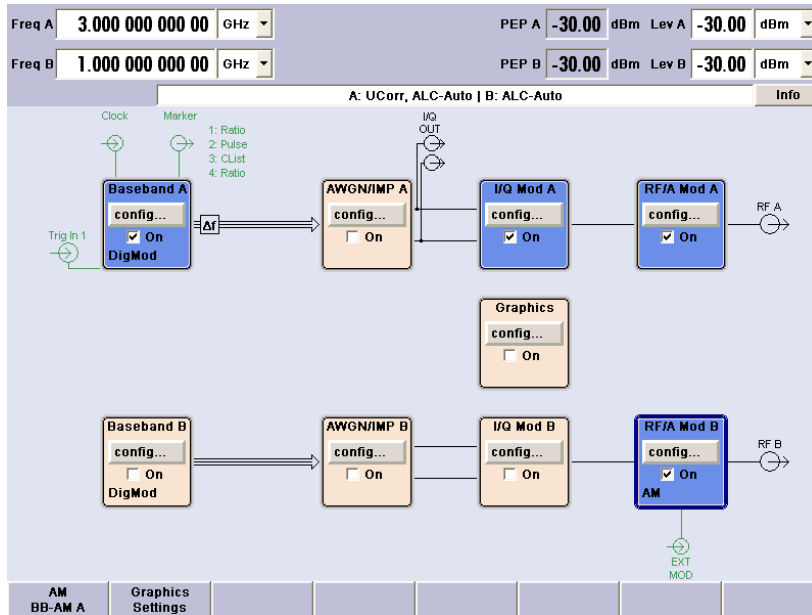

Fig. 2-6 Fully equipped two-path instrument

## Description of Individual Diagram Blocks

### Available Blocks

Block	Function of block	Status display in the block	Effect of <b>TOGGLE ON/OFF</b> key
<b>Baseband A or B</b>	Baseband source is configured and activated	Selected modulation	Switches the selected modulation (digital standard, digital modulation or ARB) on or off.
<b>AWGN/IMP A or B</b>	Additive white Gaussian noise production and digital impairments are activated	Active functions of block	Switches the active functions of the block on or off. The functions (AWGN, impairments or both) are activated in the respective menus.
<b>Graphics</b>	Graphical display is selected and activated	Status of graphical display	Opens or closes the graphics window.
<b>I/Q Mod A or B</b>	I/Q modulator is configured, I/Q impairments are selected and activated	Analog I/Q impairments, I/Q swap	Switches the I/Q modulator on or off.
<b>RF/A Mod A or B</b>	RF signal, analog modulations, list mode and sweeps are configured and activated	Active analog modulation modes of path	Switches the RF signal of the path on or off.

## Blocks of the Baseband Section

The baseband section of the R&S SMATE comprises two paths (paths A and B). Therefore, if two baseband generators are available, two baseband signals can be processed independently of each other. Routing from path A to path B and vice versa is also possible, but not after the **IMP** or **AWGN/IMP** block.

### Baseband A block



In this block, the (first) baseband source is configured and activated. The block is displayed only if a baseband generator (option R&S SMATE-B10/B11, Universal Coder and ARB) is available in the instrument. Depending on the installed software options, various digital standards, user-configured digital real time modulation or the built-in waveform generator (ARB) can be selected. The selected modulation is displayed in the block. The **TOGGLE ON/OFF** key switches the selected system on or off.

### Baseband B block



Configures the second baseband source (if installed). The block is displayed only if the instrument contains two baseband generators (option R&S SMATE-B10/B11). Depending on the installed software options, various digital standards, user-configured digital real time modulation or the built-in waveform generator (ARB) can be selected.

---

**Note:** *If two baseband generators are installed and two signals of the same standard (e.g. GSM/EDGE) should be output simultaneously, the two associated software options must also be installed (in this case R&S SMATE-K40). If only one R&S SMATE-K40 is installed and GSM/EDGE is selected in the first baseband generator, the second baseband generator is disabled for GSM/EDGE. However, a software option is not tied to a specific baseband generator. In our example, **either** the first **or** the second baseband generator can output a GSM/EDGE signal.*

---

### AWGN/IMP A block



This block is displayed only if a baseband main module is installed. In this block (digital) I/Q impairments for baseband path A can be set. With the aid of the software for AWGN generation (option R&S SMATE-K62), an (additive) noise signal can be produced in path A.

Impairments can be activated in the appropriate menus. The settings are displayed in the block. The entire block can be activated or deactivated with the **TOGGLE ON/OFF** key. If the block is deactivated, the signal passes through the block unchanged.

In addition, the differential I/Q output is configured in this block.



**AWGN/IMP B block**

This block is displayed only if two baseband main modules (option R&S SMATE-B13) are installed. In this block (digital) I/Q impairments for baseband path B can be set. With the aid of the software for AWGN generation (option R&S SMATE-K62), an (additive) noise signal can be produced in path B. If a noise signal should be applied to path A and B simultaneously, two software options R&S SMATE-K62 are required.

**Graphics block**

With this block, the baseband signal (of path A or B) can be graphically displayed in real time. The block is displayed only if at least one baseband main module is installed.

**Blocks of the RF Section****I/Q Mod A block**

The (first) I/Q modulator is configured in this block. Also the Analog Wideband I/Q mode can be selected here, which allows external I/Q signals to be directly applied to the I/Q modulator, i.e. not via the baseband section. If no baseband modules are installed, I/Q modulation is possible only in the Analog Wideband I/Q mode. I and Q components can also be swapped (I/Q Swap). (Analog) I/Q impairments can be set in addition. Unlike the impairments in the AWGN/IMP block, impairments in the I/Q Mod block also affect the externally applied signals in the Analog Wideband I/Q mode.

The status display in the block shows whether I/Q impairments and/or I/Q swap is active. I/Q modulation is switched on or off with the **TOGGLE ON/OFF** key.

---

**Note:** *An I/Q modulator provided in the R&S SMATE is automatically activated when a connected baseband source is switched on. The I/Q modulator can also be separately switched on and off (select the I/Q Mod block and press the **TOGGLE ON/OFF** key). This permits the following configuration to be obtained with a single-path R&S SMATE. The baseband source generates an I/Q signal that is output via the analog I/Q output. At the same time, the RF section generates an unmodulated carrier.*

---

**I/Q Mod B block**

This block controls the I/Q modulator of RF path B. It is displayed only if a second RF path is installed. The I/Q modulator B can be driven by modulation signals from the R&S SMATE baseband section or by external analog I/Q signals (see above, I/Q Mod A).

The status display in the block shows whether I/Q impairments and/or I/Q swap is active. I/Q modulation is switched on or off with the **TOGGLE ON/OFF** key.

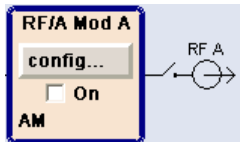
**RF/A Mod A/B**

In this block, the RF parameters and the analog modulation modes of path A are set.

The active analog modulation modes are displayed in the block. The **TOGGLE ON/OFF** key switches the RF signal of the path on and off. When the signal is switched off, the switch before the RF output symbol is open.

RF settings include:

- Frequency and reference frequency
- Attenuator settings; if required, switching to the high-power mode if a high-power option is installed for path A.
- Frequency and level sweep
- List Mode settings. In this mode, extremely fast frequency and level settings can be made.

---

**Note:** *Numeric values for frequency and level are entered best and quickest with the aid of the **FREQ** and **LEVEL** keys.*

---

Available analog modulation modes:

- Amplitude modulation
- Broadband amplitude modulation
- Frequency modulation (option R&S SMATE-B22)
- Phase modulation (option R&S SMATE-B22)
- Pulse modulation

---

**Note:** *For modulation modes that can be simultaneously used, refer to the R&S SMATE data sheet.*

---

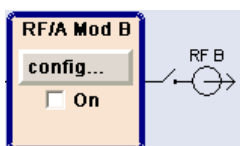
**RF/A Mod B**

In this block, settings are made for analog modulation and RF parameters of path B. This block is displayed only if a second RF path is installed.

## Example of Setup

In the example, a simple QPSK-modulated signal is configured and displayed. Proceed as described below:

1. Activate default (preset) state.
2. Select and activate digital modulation.
3. Set frequency and level and activate RF signal.
4. Select graphics display of I/Q signal.

### Step 1: Activate default (preset) state

**Preset**

Set a defined instrument state by pressing the CTRL+P key combination on the external keyboard.

Remote control command:  
\*RST

Freq 1.000 000 000 00 GHz
 RF OFF
PEP -30.00 dBm Lev -30.00 dBm

ALC-Auto Info

```

graph LR
    Baseband[Baseband] --> AWGN[AWGN/IMP]
    AWGN --> IQ[I/Q Mod]
    IQ --> RF[RF/A Mod]
    RF --> RF_OUT[RF]
    Graphics[Graphics]
    
```

**Step 2: Select and activate digital modulation**

Select the Baseband A block using the cursor keys. on the external keyboard.

Remote control command: -

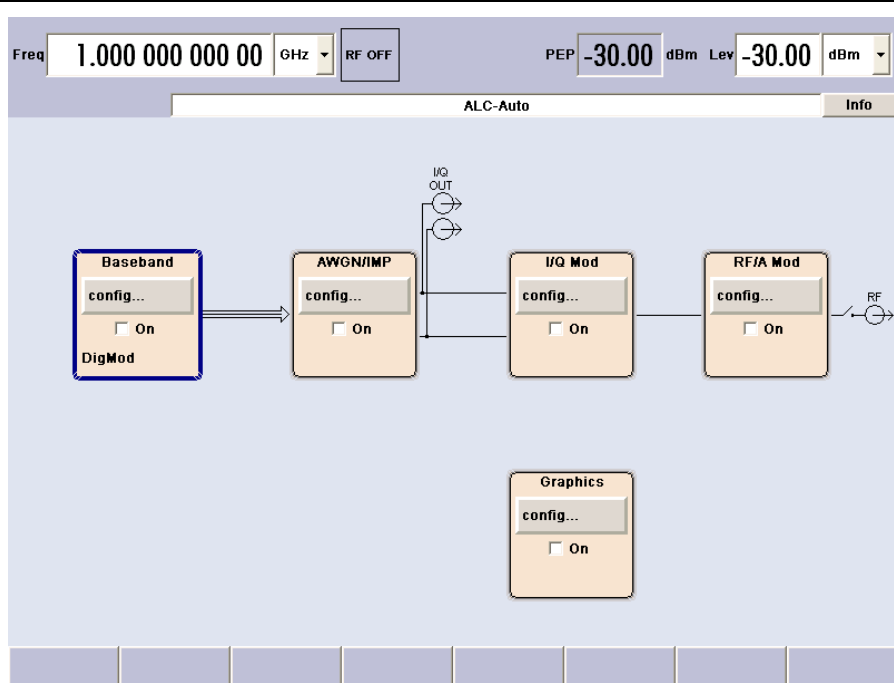

Press the Enter key to open the menu where the digital modulation can be selected.

Remote control command: -

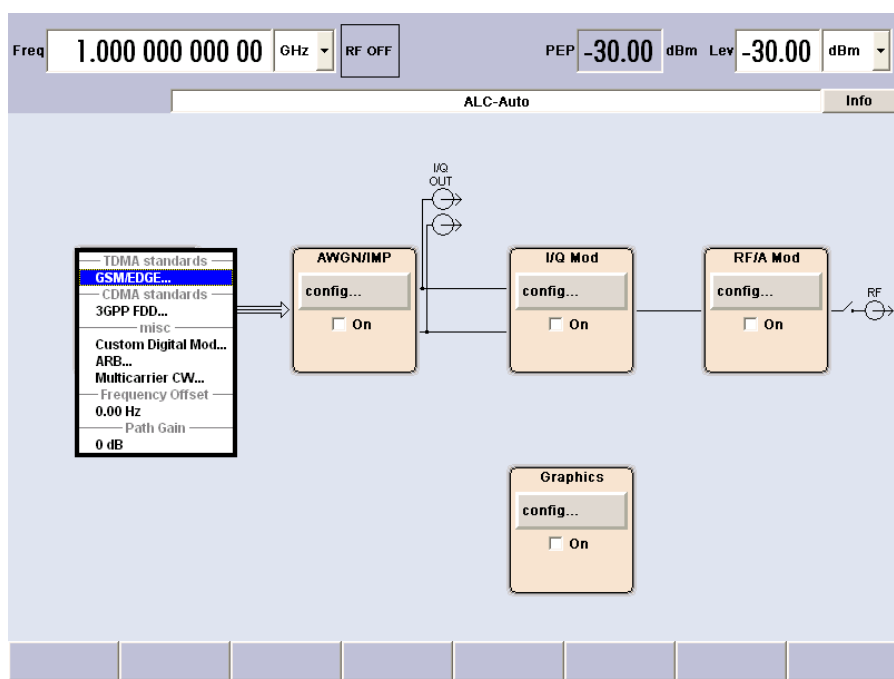

Highlight **Custom Digital Mod...** by using the cursor keys.

Remote control command: -

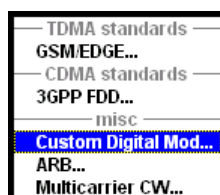

Press the Enter key to open the **Custom Dig. Mod.** menu.

Remote control command: -

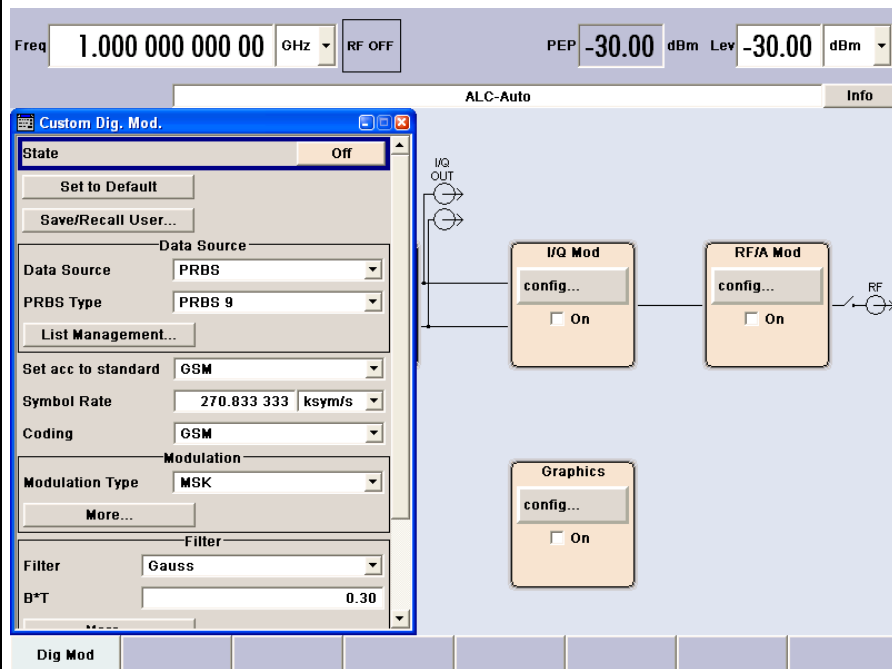

Highlight the **Symbol Rate** parameter using the cursor keys, and then enter the desired symbol rate with the aid of the numeric keys.

Remote control command:  
 SOUR:BB:DM:SRAT  
 10MHz

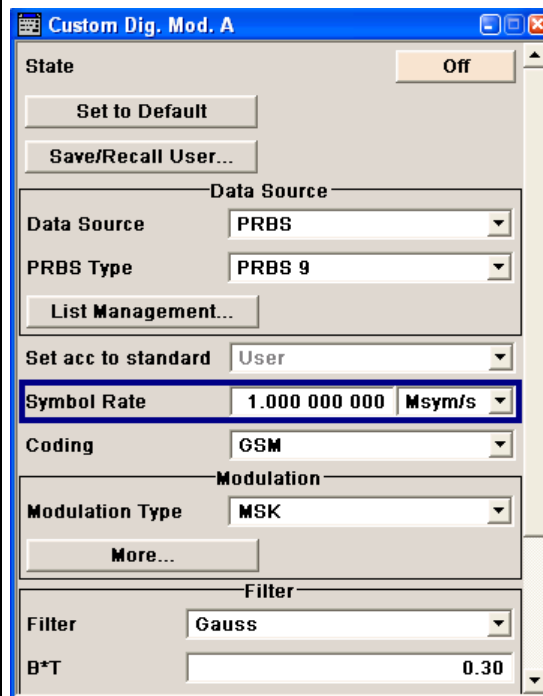

Highlight the **Coding** parameter using the cursor keys.  
 Open the selection list by pressing the Enter key.  
 Select **Off** using the cursor keys, and activate this setting with the Enter key.

Remote control command:  
 SOUR:BB:DM:COD OFF

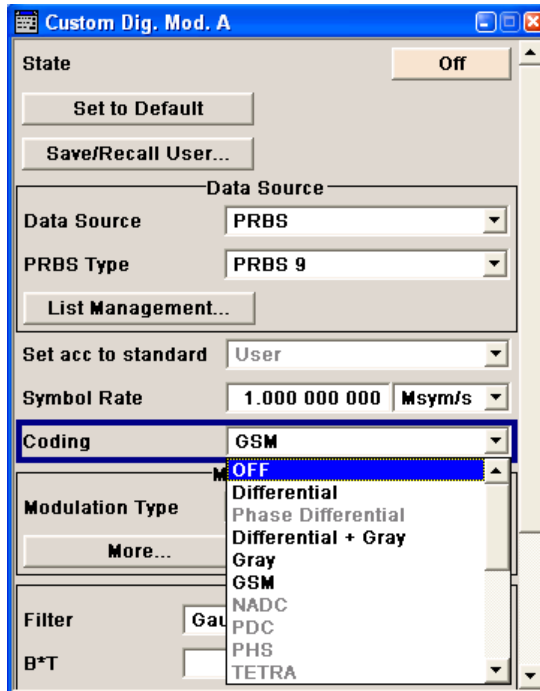

Set **Modulation Type QPSK** and **Filter Root Cosine** with **Roll Off Factor 0.3** in the same way.

Remote control commands:  
 SOUR:BB:DM:FORM QPSK  
 SOUR:BB:DM:FILT:TYPE RCOS  
 SOUR:BB:DM:FILT:PARAM:RCOS 0.3

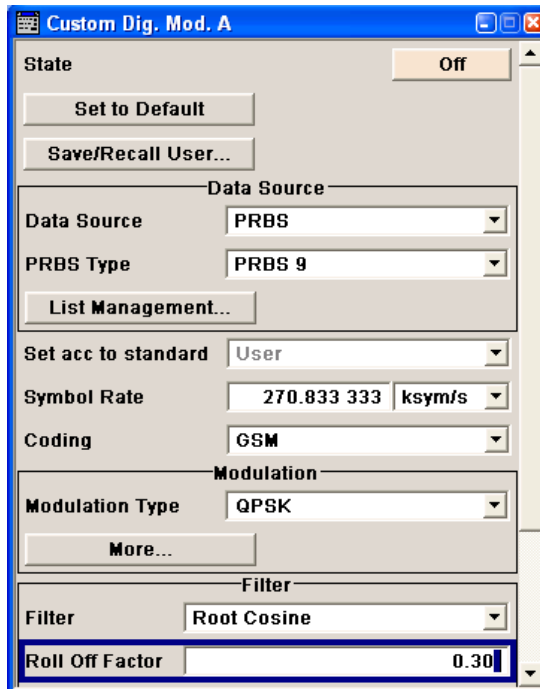

Finally, switch on digital modulation by activating **State On**.

Remote control command:  
SOUR:BB:DM:STAT ON

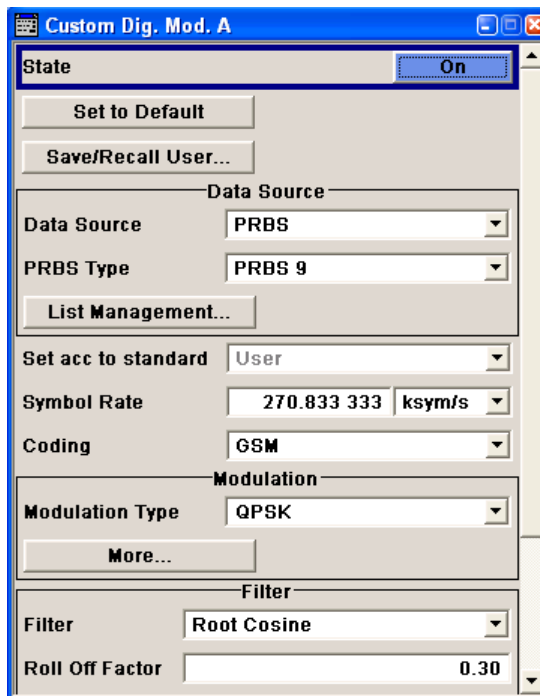

Press the CTRL+D key combination to display the complete block diagram.

Remote control command: -

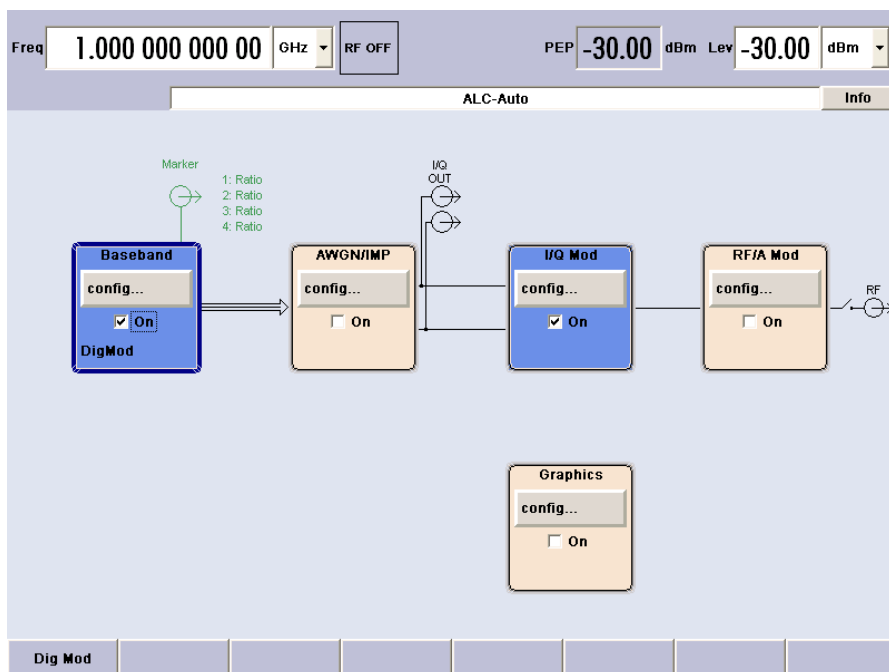

To indicate the active state, the **Baseband** block is displayed in blue. The **I/Q Mod** block is automatically activated. The **RF/A Mod** is not yet active, which means that no RF signal is output. The entry in the Winbar indicates that the Custom Dig. Mod. menu is still open in the background.

The menu can be displayed in the foreground by pressing the ESC key.

Press the CTRL+H key combination to minimize the menu again.

Press the ESC key again to close the menu.

Remote control command: -

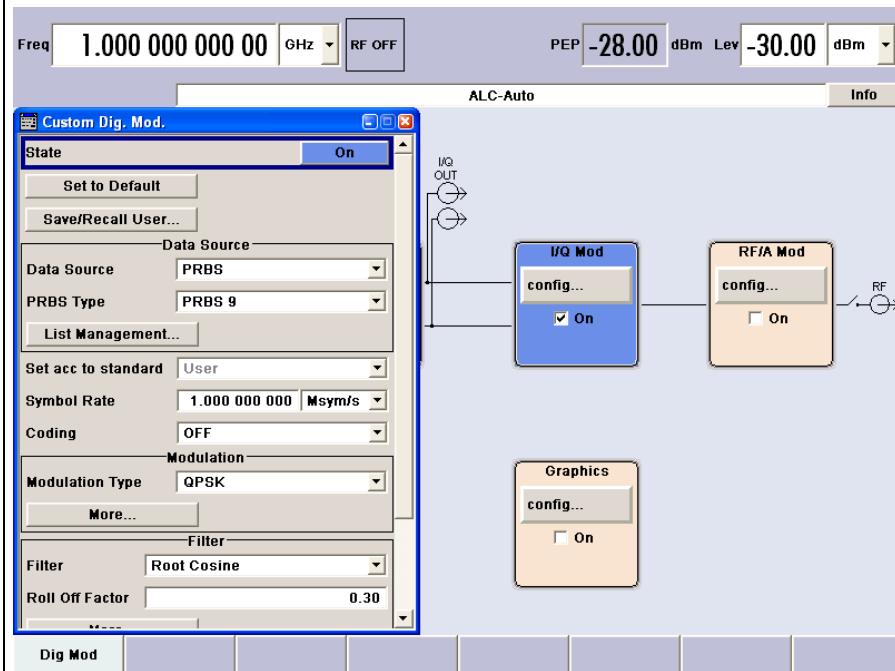

**Step 3: Set frequency and level and activate RF signal**

Press the CTRL+F key combination to activate the editing mode for frequency entry. The frequency entry field in the header section of the display is highlighted.

Enter the frequency using the numeric keys and terminate the entry by pressing the ALT+F9 key combination for unit GHz.

Remote control command:  
SOUR:FREQ 2E9

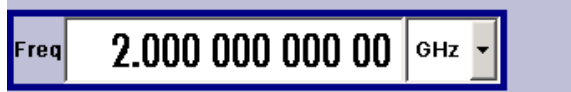



Enter the level in the same way after pressing the CTRL+L key combination.

Remote control command:  
SOUR : LEV -5dBm



Press the CTRL+D key combination to display the complete block diagram.

Select the RF/A Mod block and activate it.

Remote control command:  
OUTP : STAT ON

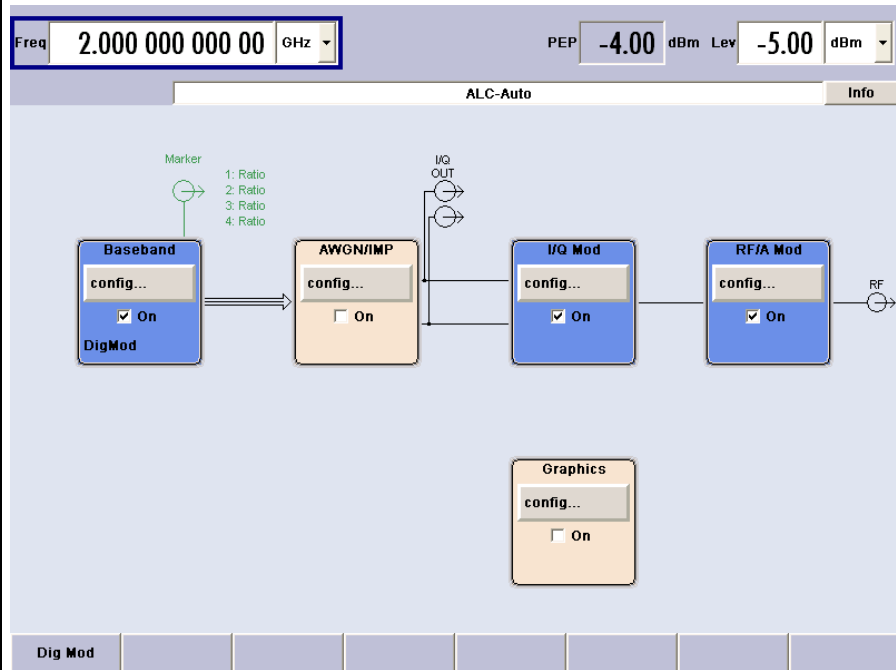

The QPSK modulation signal is now present at the RF output.

**Step 4:** Select graphics display of I/Q signal

Select the Graphics block and open the respective menu.

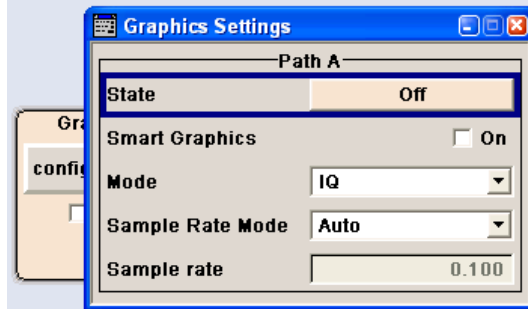

Activate display of the I/Q diagram by selecting **State On** with the rotary knob.

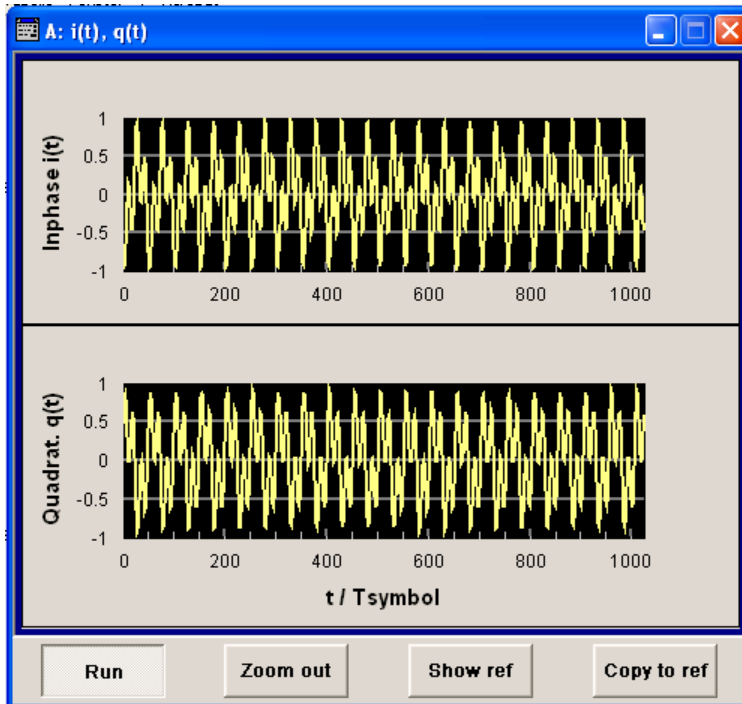

The R&S SMATE comprises a comprehensive **info** and **help system** in manual control. Context-sensitive help can be called any time with the F1 key. The help system indicates the currently selected parameter and offers additional services such as cross references, index and contents. The content of the help system corresponds to the operating manual of the R&S SMATE.

Warning and conflict messages caused by incorrect operation as well as further information are displayed in the **Info line**. A complete list of existing conflicts is displayed when the CTRL+I key combination is pressed. Additional information on entries can be requested from the help system. The history function permits display of all messages.

**Assistants** simplify the completion of tables. After data entry in the assistant, the table is modified only after the **Accept** button has been pressed. Pressing the **Accept** button also stores the assistant data.

Detailed operating instructions follow in Chapter 3, "[Manual Operation](#)".

Menus and instrument functions are described in detail in Chapter 4, "[Instrument Functions](#)".

## Contents - Chapter 3 "Manual Operation"

<b>3 Manual Operation.....</b>	<b>3.1</b>
Introduction - Manual Operation.....	3.1
Legend of Manual Controls .....	3.1
Operating Concept .....	3.4
Display .....	3.8
Frequency and Level Setting - Display.....	3.8
Status Information and Messages - Display.....	3.9
Info Window - Display.....	3.10
Block Diagram - Display .....	3.11
Winbar and Softkeys - Display .....	3.13
Menu Structure - Display.....	3.13
Graphical Display of Output Signal Characteristics .....	3.16
Setting Parameters.....	3.16
Calling a Menu - Setting Parameters .....	3.17
Selecting a Control Element - Setting Parameters.....	3.18
Switching Parameters On/Off - Setting Parameters.....	3.18
Selecting and Exiting a Menu Area - Setting Parameters.....	3.18
Entering a Value - Setting Parameters.....	3.20
Selecting a Unit - Setting Parameters .....	3.21
Selecting a Value from a List - Setting Parameters .....	3.22
Terminating Entries - Setting Parameters .....	3.23
Restoring the Previous Value - Setting Parameters.....	3.24
Menu Operation.....	3.25
Editors .....	3.26
List Editor.....	3.26
Data Editor.....	3.28
Control and Marker List Editor.....	3.30
Help system.....	3.33
File Management.....	3.34
File Select Menu.....	3.36
File Manager.....	3.37



# 3 Manual Operation

## Introduction - Manual Operation

The following chapter describes the manual control of the R&S SMATE is provided even though the Vector Signal Generator is primarily intended to be remote-controlled via the GPIB interface or a LAN connection. Manual control using an external monitor, mouse and keyboard or from an external PC via a network link might help the user to get familiar with the instrument. The chapter includes a description of screenshots, operation of menus and the block diagram and the setting of parameters.

The introduction into remote control is provided in section "[Remote Control - Basics](#)", on page 5.1.

The Vector Signal Generator R&S SMATE can be operated manually either via the interactive block diagram or via a menu tree. All menus are in the form of windows that can be operated in the same way. Key combinations on the external keyboard or alternatively a mouse allow direct access to entries and settings. A key emulation menu can be called from the window XP operating system (START - Programs - Accessories - Accessibility - On-Screen Keyboard). Thus, operation via mouse only is possible. This is supported by an R&S SMATE specific key emulation that emulates the front panel function keys of the R&S<sup>®</sup> SMU200A. The R&S SMATE-specific key emulation is called by a right-click of the mouse. An overview of the key combinations can be found in the following section "[Legend of Manual Controls](#)".

The clear-cut display shows the current signal generator state. Graphs, spectra, vector diagrams, etc, can be called for a visual check of the output signal. Numerous help functions support the user in signal configuration.

Chapter 4 includes a detailed description of signal generator functions. Chapter 2 explains the operating concept in general and includes a brief introduction to operation by a step-by-step description of the configuration. Remote control of the instrument is described in chapters 5, 6 and 7.

## Legend of Manual Controls

The following table lists all available key combinations used on the PC keyboard to trigger functions on the instrument. Keyboard labels are described in alphabetical order.

In addition, a front panel key emulation and an on-screen keyboard can be used for manual operation with mouse only (see below).

Key of PC keyboard / Function Button	Short description of function	Function
. / *...#	Special characters	Enters a special character, e.g a period/decimal point.
+/-	Sign	Enters the sign.
- / (shift+) a...z	A↔a	Switches between upper-case and lower-case letters.
ALT + F9	Units G/n / dB $\mu$ V / dBu	Selects the unit Giga/Nano, dB $\mu$ V for the RF level and dBu for the LF level.
ALT + F10	Units M/ $\mu$ / $\mu$ V	Selects the units Mega/Micro and $\mu$ V for RF levels.
ALT + F11	Units k/m / $\mu$ V	Selects the units Kilo/Milli and $\mu$ V for RF levels.

Key of PC keyboard / Function Button	Short description of function	Function
ALT + F12	Enter function Unit dBm	Confirms entries in the base unit and values without a unit. Selects dBm for the RF level and dB for level offset and level step width.
Backspace	Clears entry	Clears the last entry (number, sign or decimal point)
Cursor keys	Cursor	Moves the cursor.
CTRL+ 0-9 / a...z		Enters the number/letter.
CTRL + C	Recalculate	Starts recalculation of the signal.
CTRL+ D / Diagram	Block diagram	Sets the cursor on the block diagram and hides all menus.
CTRL + E / Setup	Setup menu	Opens the setup menu for general instrument settings.
CTRL + F1 – F8	Softkey 1 – 8	Triggers the function assigned to the softkey.
CTRL+ F / Freq	Frequency	Activates the frequency entry.
CTRL + G	Closes menus	Closes an active menu.
CTRL+ H	Hide	Minimizes the active menu. Pressing the respective button in the Winbar opens the menu again.
CTRL + I / Info	Info	Opens/closes the info window
CTRL + L / Level	Level	Activates the level entry.
CTRL + M / Menu	Menu	Calls the menu selection list.
CTRL + O / Mod On/Off	Modulation on/off	Switches modulation on/off. MOD OFF is indicated in the status line.
CTRL + P / Preset	Preset	Restores a defined basic instrument setup.
CTRL + Q / Local	Local	Switches the instrument from remote control to manual control.
CTRL + R / RF On/Off	RF on/off	Switches the RF output signal on/off. RF OFF is indicated in the status line. Both RF output signals are always deactivated in the case of two-path instruments.
CTRL + S / File	Storage under Windows	Activates the menu for storing instrument settings.
CTRL + T	Toggle on/off	Switches a block or parameter on/off.  Toggles between the different possibilities of setting a selection parameter.
CTRL+ Y / Hardcopy	Hardcopy	Opens the menu for configuring and starting a hardcopy.
CTRL + W / Winbar	Winbar	Displays the Winbar in the foreground/background.
Einfg	Insert	Activates the insert mode.
Enter	Enter	Terminates an entry.

Key of PC keyboard / Function Button	Short description of function	Function
ESC	ESC	Selects the next higher menu/selection level. When the editing mode is exited with ESC, the previous value is restored.
F1 / Help	Help	Opens/closes context-sensitive help.

The R&S SMATE also provides a front panel key emulation to enable fast execution of the instrument specific functions by mouse. The emulation is called on the external monitor by a right mouse click. The instrument functions are executed by a mouse click on the associated button. The buttons are listed with the respective key combinations in the first column of the table.



In addition, the Windows XP operating system provides a keyboard emulation that can be used for system settings if no external keyboard but a mouse is available. It is called on the external monitor in the **START - Programs - Accessories - Accessibility** menu, selection **On-Screen Keyboard**.



# Operating Concept

The operating concept for manual control enables the user to make settings as intuitively as possible and at the same time gives a permanent overview of characteristics of the generated signal and of the current instrument state. Numerous on-line help functions support user settings.

### The block diagram is the core of the operating concept.

A large graphics display showing the current configuration and the signal flow in the form of a block diagram is the core of the operating concept of the Vector Signal Generator R&S SMATE. The block diagram gives an overview of signal configuration, and the graphical elements can be accessed for operation. The desired element is selected by means of the cursor keys and the associated setting function is called by pressing the Enter key. Required menus and graphs are displayed on the block diagram which is displayed again in the foreground whenever the CTRL+D key combination is pressed.

### Permanent display of frequency and level of the RF output signal

The main characteristics of the RF signal, frequency and level, are permanently displayed in the header section of the screen and can be directly set in the display fields after the CTRL+F or CTRL+L key combination is pressed. Status messages for the output signal are displayed in addition to frequency and level.



### Operation via the graphics interface

Menus are assigned to the specific function blocks in the block diagram. The function blocks represent elements of signal generation, e.g. the baseband block which contains all menus required for baseband signal configuration. In this block all digital standards and the digital modulation can be selected. Function blocks displayed with a blue frame can be directly switched on and off by means of the CTRL+T key combination. In the example, digital modulation can be activated in this way. The menus of the highlighted function blocks can be called by pressing the ENTER key.

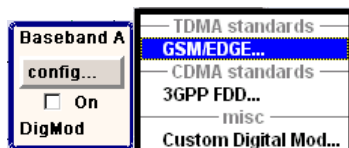

The signal flow between the function blocks and the employed inputs and outputs are also shown.

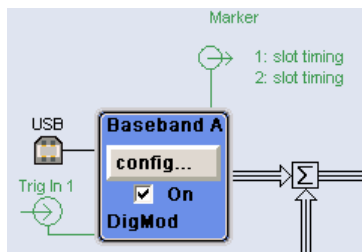

The menu tree can be opened and closed with the CTRL+M key combination. The menu tree is organized in the same way as the directories under Windows. The function blocks correspond to the first directory level, the menus to subdirectories.





### Operation corresponds to the Windows concept

To offer the user a familiar environment, operation is very similar to operation of Windows user interfaces. All menus and tables are made up of known elements, e.g. selection lists,

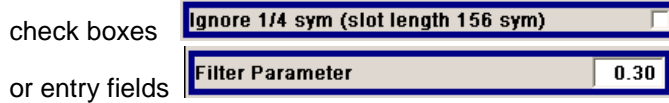
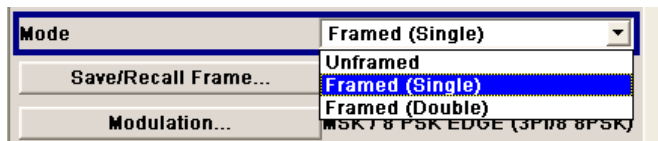

A blue frame indicates that the selected item is active. In the highlighted element, entries can be made.

### Clear settings with the aid of independent submenus

A separate menu is opened for each menu and submenu. The menus can be operated independently of each other, i.e. none of the menus requires that settings in other menus be completed before it can be closed. This ensures flexible operation at all times.

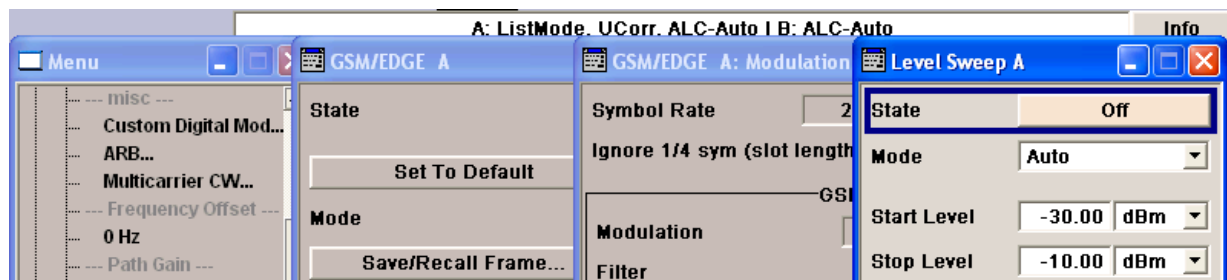

### The Winbar gives an overview of menus and simplifies their access.

The menus are displayed on top of the block diagram but they can be "hidden", i.e. displayed in the form of a button in the Winbar at the lower end of the screen ( CTRL+H key combination). This makes room on the screen for other displays that may be required but the setting menus can thus be accessed any time.

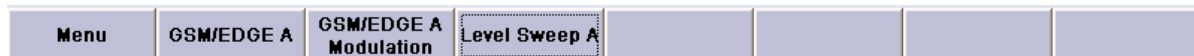

### The keys are assigned simple functions

Most key combinations directly perform a simple function. Since a great number of settings can thus be made by a keystroke, operation is easy. For instance, the ESC key closes the active menu; with the CTRL+R key combination key the RF output signals can be switched on or off.

An exception are key combinations that call a menu such as the CTRL+R key combination which opens the complete menu tree of the R&S SMATE, the CTRL+E key combination which opens the menus for general instrument settings or the CTRL+S key combination which opens the menu for file management.

### Help functions support the user

Numerous help functions support the user in signal configuration.

The valid setting range can be displayed for each numeric parameter. This requires a short wait after activation of the entry field. The range is then displayed automatically after a few seconds. If the entered value is outside the permissible range, the next permissible value is automatically set and a message is output (see below).

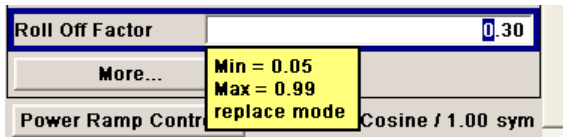

Context-sensitive help for each parameter can be called with the F1 key:

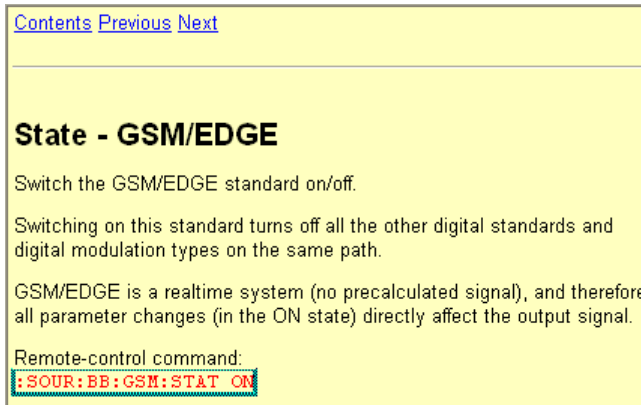

Each help page is part of a comprehensive online help function which can be called by means of an index, a content tree or the **Previous / Next** buttons.

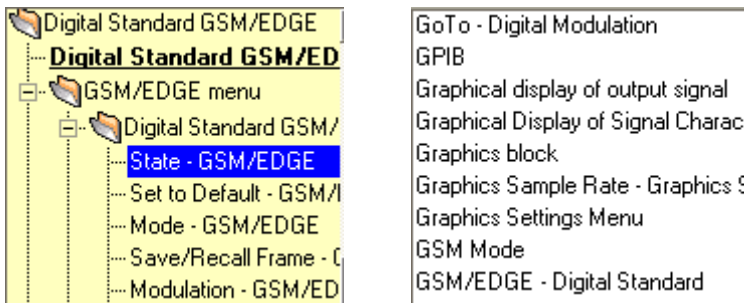

**Messages indicate the current instrument state**

A great variety of different messages such as status messages, error messages, warnings or information are displayed in the header field of the screen. With the aid of the CTRL+I key combination, help pages can be called for most of the messages. They provide background information on the message and indicate operating steps that may be required. All messages are explained in the online help which can be called with the F1 key.



**Graphical display of data structure**

The structure of the baseband signal is graphically displayed in the respective menus; the individual signal elements can be graphically selected for processing.

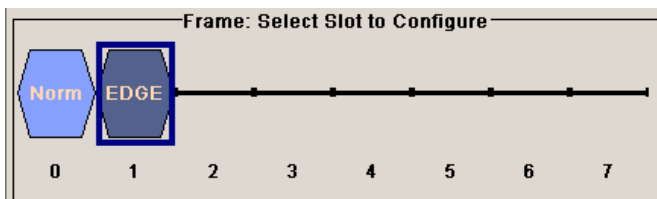

**Definition of control signals with the aid of a graphics editor**  
 Control signals are also graphically configured.

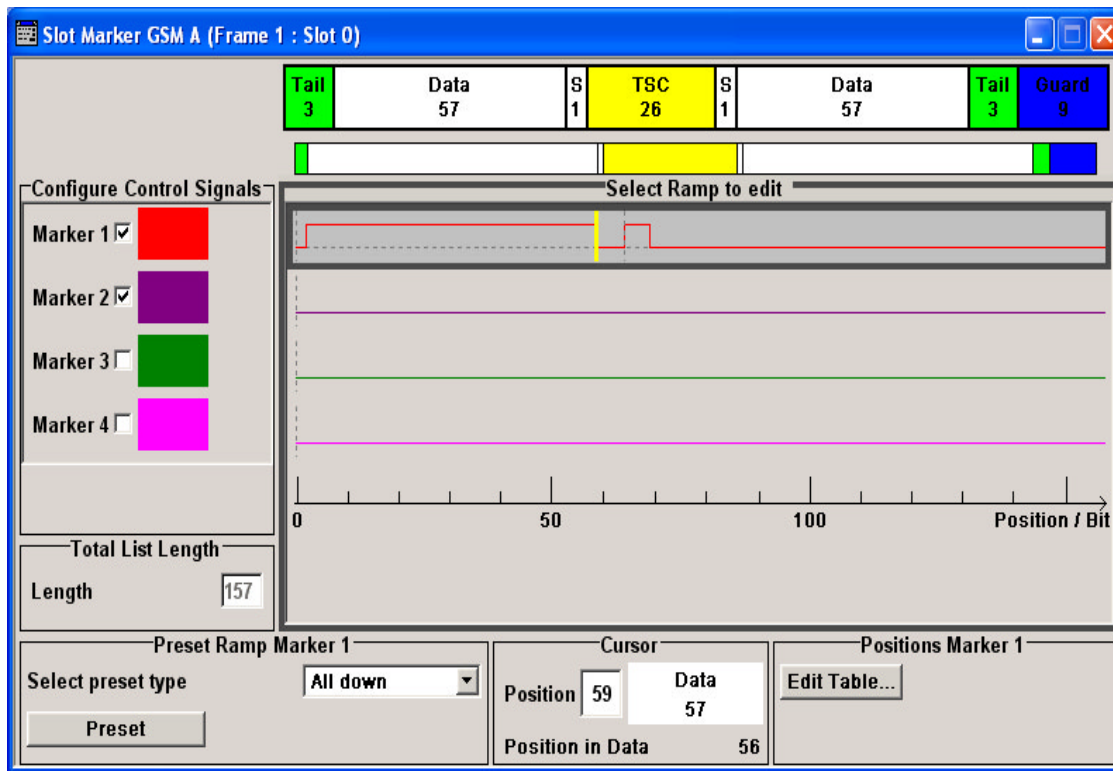

**Graphical display of output signal in a diagram**

The output signal can be graphically displayed in a number of diagrams. This allows a fast check of signal characteristics. Zoom functions and the insertion of a reference trace permit in-depth evaluation without an external analyzer being required.

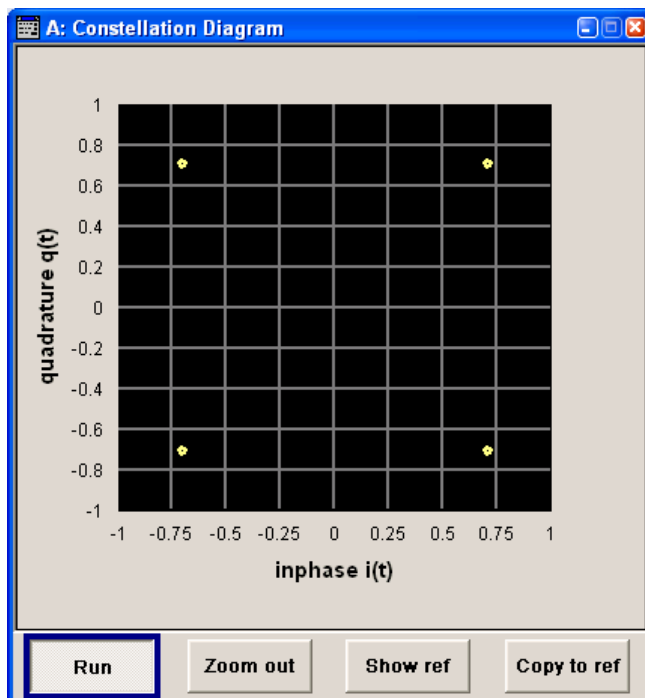

# Display

The external display shows the current signal generator state and offers graphical elements for direct operation. It is divided into three sections:

- The frequency and level display with info line indicates the main output signal parameters and reports the current state with status, error and warning messages.
- The block diagram shows the instrument configuration, the signal characteristic as well as the inputs and outputs used and permits interactive operation via graphics elements. Active menus and graphs are displayed on top of the block diagram.
- Winbar with labelled softkeys for menu display.

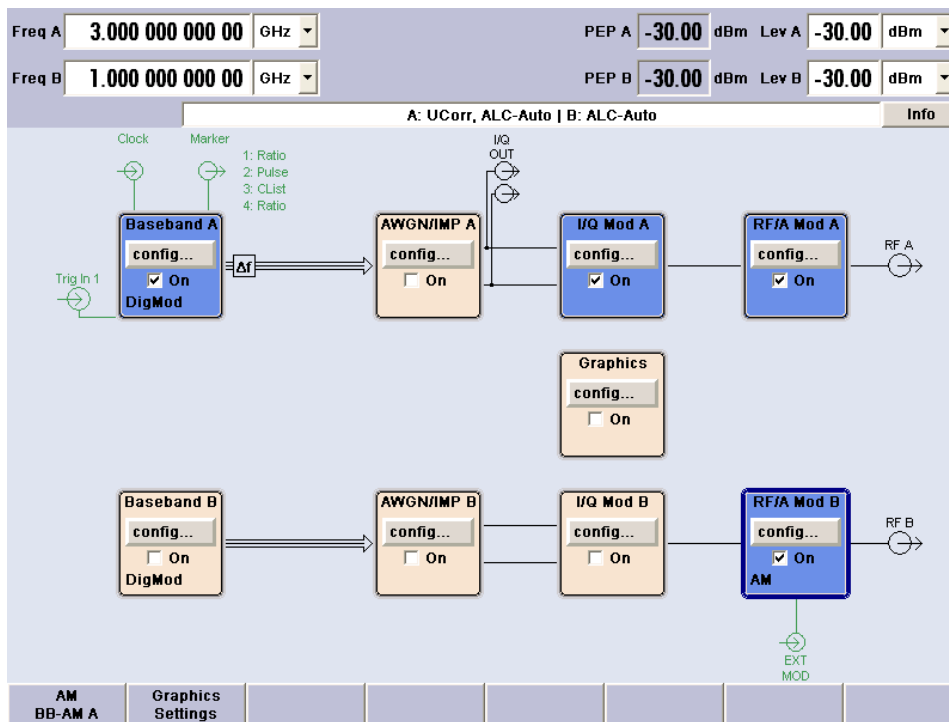

## Frequency and Level Setting - Display

Frequency/level settings and a few status messages (see below) are displayed in the header field of the screen. The display may vary depending on the instrument's operating mode:

- In the case of two-path instruments, the RF information for the two paths is displayed in two lines.
- In the sweep mode, the current frequency or level of the output signal is displayed. The status message **ListMode** is displayed in the info line.
- In the list mode, neither the current frequency nor level is displayed, the indication is dimmed.
- If user correction is active, the status message **UCorr** is displayed in the info line.
- In the case of digital modulation, **Freq** indicates the frequency, **PEP** the peak envelope power and **Level** the average level.

It should be noted that the signal at the RF output may differ from the indicated value by a set offset (frequency or level) (see sections "[RF Frequency and Phase - Frequency - Phase](#)" and "[RF Level - Level - EMF](#)" in chapter 4).

## Status Information and Messages - Display

The status information and messages are displayed in the header section of the screen. The messages differ with respect to their importance (errors, warnings, info) and the time of their appearance (brief and permanent messages). They require different treatment by the user. Further information on all messages can be called in the info window (see section "[Info Window - Display](#)", page 3.10). Chapter 9, "Error Messages" includes an overview of all status information and messages as well as instructions for error elimination.

### Status Information

The status information gives the user an overview of the main operating states and settings of the R&S SMATE. The states are indicated for information only and do not necessitate any action by the user. Status information is displayed between the frequency and level fields, at the left of the info line or in the info line itself. On two-path instruments, all states that can occur independently in the two paths are displayed separately for each path. The associated path is indicated in the info line.

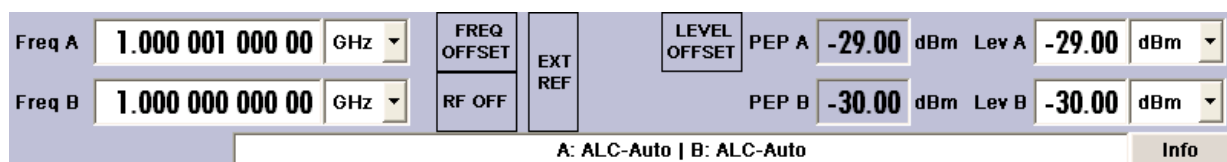

### Messages

Messages indicate errors in the instrument. They are displayed in the info line in different colours depending on their importance and display duration. Errors (e.g. no calibration data) are displayed in red, information (e.g. file not found) and warnings in black. Warnings indicate less significant errors (e.g. the instrument operates outside specified data).

#### Brief messages

Brief messages report automatic settings in the instrument (e.g. switching off of incompatible types of modulation) or on illegal entries that are not accepted by the instrument (e.g. range violations). They are displayed in the info line on a yellow background. They are displayed on top of status information or permanent messages.

Brief messages do not normally demand user actions and disappear automatically after a brief period of time. They are stored in the history, however.

#### Permanent messages

Permanent messages are displayed if an error occurs that impairs further instrument operation, e.g. a hardware fault. The error signalled by a permanent message must be eliminated before correct instrument operation can be ensured.

The message is displayed until the error is eliminated. It covers the status display in the info line. After error elimination, the message automatically disappears and is also recorded in the history.

## Info Window - Display

A few operating states and the current message are displayed in the info line (see also chapter 9 "[Error Messages](#)").

The info window with a list of current permanent messages and a detailed description of each message can be opened with the CTRL+I key combination.

The upper section of the info window contains a list of all current permanent messages in the order of their occurrence, i.e. the most recent message is displayed first. In the lower section of the window, additional information on the highlighted message is displayed.

A history of all messages that have occurred since instrument switch-on can be called with the **History** softkey. The most recent message is displayed first.

The screenshot shows the Info Window interface. At the top, it displays 'A: UCorr, ALC-Auto | B: ALC-Auto' and an 'Info' button. Below this is a table with columns 'Lev', 'SCPI', and 'Text'. The table contains four rows: three error messages (Err 463 'Filename missing', Err 241 'No current list', Err 463 'Filename missing') and one info message (Info 0 'SawRcl Manager Info: operation complete -Recall completed'). Below the table is a yellow highlighted area with the text '- No pending errors.'. At the bottom, there are four softkey buttons: 'Delete', 'Delete all', 'Del. volatile', and 'History'.

Info line  
List of current messages with short message text.  
Detailed description for highlighted message  
Softkeys

The messages are color-coded according to their level. Device-specific messages are red, infos and remote control error are black. The level is also indicated in the **Lev** column (Err, Sys or Info). Column **SCPI** indicates the SCPI error code.

With the aid of the softkey buttons, error messages can be cleared and a history of all messages called.

**Delete** Clears the highlighted message. This button is available only if the history of the messages is displayed.

Remote-control command:  
(see below)

**Delete All** Clears all messages. This button is available only if the history of the messages is displayed.

Remote-control command:  
SYST:ERR:ALL

**Delete Vol.** Clears all brief messages. This button is available only if the history of the messages is displayed.

Remote-control command:

**History** Calls the list of all messages that have occurred since instrument switch-on. The most recent messages are displayed at the top of the list. When the button is pressed again, the list of current messages is displayed.

Remote-control command:  
:SYST:ERR? or :STAT:QUE?

(Each time a SYSTem:ERRor? or :STATus:QUEue? query is sent, the oldest entry in the error queue is returned and at the same time cleared in the list).

## Block Diagram - Display

The block diagram shows provided options, signal configuration and the currently selected signal flow of the generator with inputs and outputs used. Signal generation can be completely operated from the block diagram. The highlighted function block can be directly switched on and off with the CTRL+T key combination. Pressing the Enter key opens the associated setting menu.

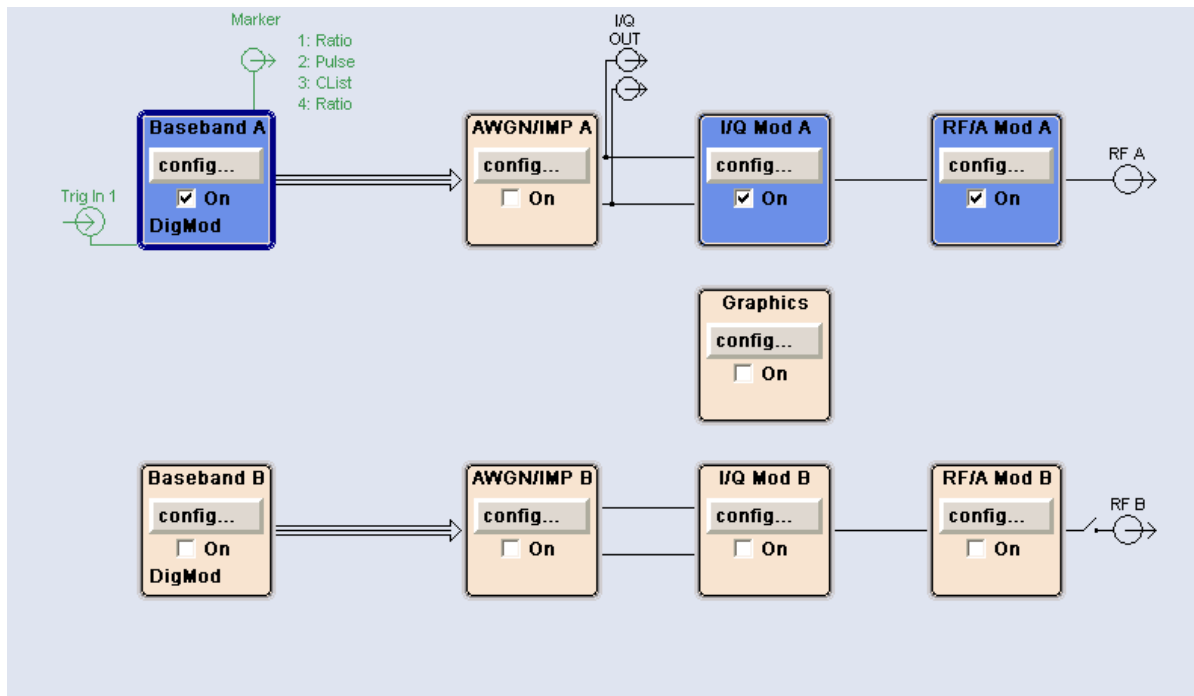

Each block represents a function of signal generation. The function is indicated in the headline of the block, e.g. **Baseband A**. In this block, the digital modulation signal, the digital standards, arbitrary waveform generation and multicarrier CW are set, for instance.



In the check box  **On**, the respective function can be quickly activated/deactivated with the CTRL+T key combination. After activation, the block is displayed in blue.

Status information is displayed below the check box. It is different for the different blocks. In the baseband block, for instance, the selected modulation and associated additional information, e.g. the number of channels, are indicated.

Pressing the Enter key opens the associated setting menu. In all function blocks where the signal flow can be influenced, the top menu level for setting **signal routing** parameters is offered.

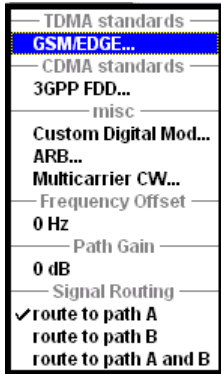

The input/output symbols in the block diagram show the currently used inputs and outputs of the signal generator. Unused inputs and outputs are not shown. The lines indicate the signal flow.

Symbols and labels refer to the corresponding inputs and outputs on the front and rear panel of the signal generator. The direction - input or output - is indicated by an arrow.

**Example:**

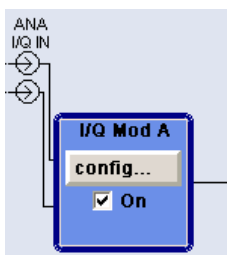

The symbols indicate the inputs for the analog I and Q signal on the instrument front panel.

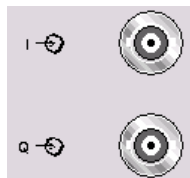

The marker characteristics are listed next to the marker symbol of the active markers.

Symbols and lines are displayed in different colours depending on their function.

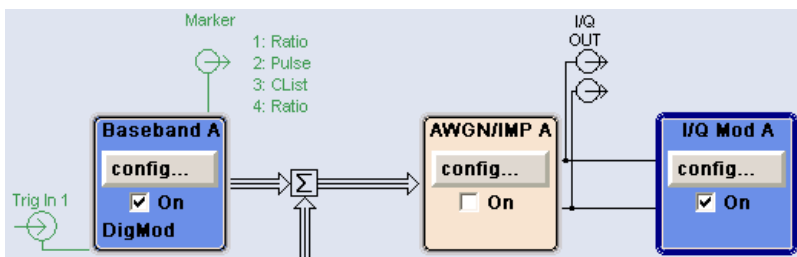

- The baseband signal is indicated by a three line arrow, the I- and Q-components of the signal by a single-line arrow.
- Addition of signals is indicated by the summation sign.
- Connections are indicated by a "solder point".
- Black is used for the generated signal.
- Green is used for control signals.

The signal flow is configured in the individual menus. User interfaces are configured in the Setup-Environment - Global Trigger/Clock/External Inputs - USER Marker /AUX I/O Settings menu.



## Winbar and Softkeys - Display

The Winbar with eight buttons is displayed below the block diagram. Labelled buttons represent open menus, the label indicates the menu. If several menus are open, the button of the currently active menu is displayed in a lighter colour. The buttons also assign functions to the softkeys of the next lower level for front-panel operation. Up to eight menus may be open simultaneously. When the ninth menu is opened, the menu that was opened first is automatically closed.

Dig Mod A	Dig Mod A Modulation	Dig Mod A Data Src	Digital Mod A Pow Ramp				
-----------	----------------------	--------------------	------------------------	--	--	--	--

Some menus, e.g. data and list editor menus, cover the Winbar and assign menu-specific functions to the front-panel softkeys by way of the menu buttons.

Any of the open menus can be activated either with the respective button in the Winbar or the front-panel softkey. In combination with the keys for menu operation (ESC, CTRL+H), convenient menu operation can be ensured.

Menu operation is described in section "[Menu Operation](#)", page 3.25.

## Menu Structure - Display

The parameters are set in the menus. Menus are called either via the function blocks in the diagram or by means of the CTRL+M key combination. The menus are displayed on top of the block diagram. If the menu buttons assign menu-specific functions to the softkeys, the Winbar is hidden.

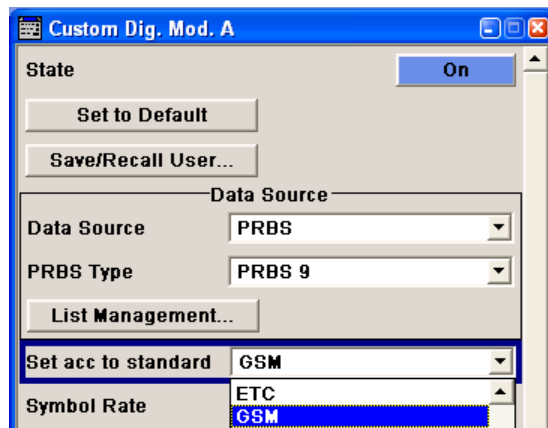



This section describes the menu structure. Menu operation is described in section "[Menu Operation](#)", page 3.25, the setting of parameters in section "[Setting Parameters](#)", page 3.16.

The menus are in Windows format. They differ in details depending on their function but they consist of the same main elements.



**Menu header**

The header line contains the name of the menu (e.g. Custom Dig. Mod. A) and the buttons for minimizing  and closing  the menu. The buttons can be operated with the mouse. For operation from the external key board, the CTRL+H key combination and the ESC key can be used.

The remaining menu area is variable and comprises various fields for setting parameters.

Each of the setting fields is assigned a parameter name. The kind of setting varies depending on the parameter to be set.

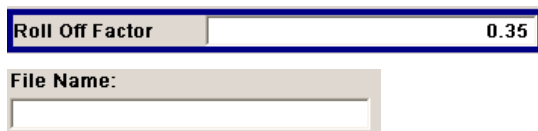

**Entry field**

A numeric value (e.g. roll-off factor) or an alphanumeric value (e.g. file name) can be entered in this field.

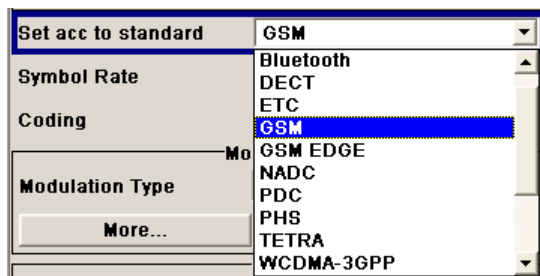

**Selection field**

The  button indicates that a selection can be made from a list. The fold-down selection list is displayed below the selection field. Depending on the number of entries, the full list or only part of it is shown.

One entry at a time can be selected from the list.

If an item is not available for selection, it is printed in grey and cannot be accessed.

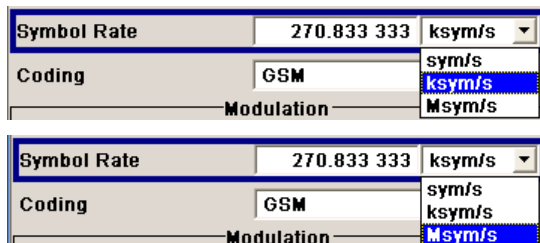

**Units**

The unit of a parameter is displayed next to the value. When the parameter is edited, the unit is selected either from the list or by means of the front-panel keys. When the entry is completed, the unit can be changed. In this case the value remains unchanged but is automatically adapted to the new unit.



**Check-box field**

If the check box is ticked, the associated parameter setting is active (e.g. switched on).

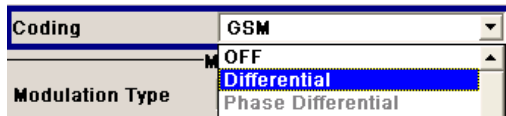

**Access denied**

Some settings can only be made in a specific configuration. If setting is not permitted with the specific configuration selected, the respective item is disabled and displayed in grey and the entry or selection field cannot be accessed.

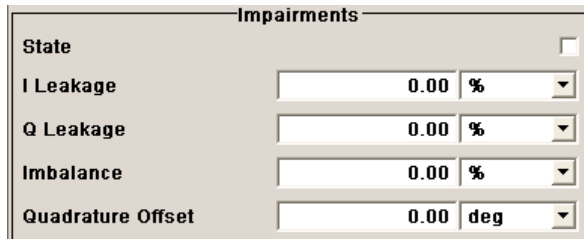

**Menu area**

Several fields of associated but separately set parameters can be organized in a menu area.

The menu area is framed and labelled with the function common to all parameters (e.g. Impairments).

	Chan Type	Enh Sett	Slot Form	Symb Rate ksp/s
0	P-CPICH	No		15
1	S-CPICH	No		15
2	P-SCH	No		15
3	S-SCH	No		15
4	P-CCPCH	Config...		15
5	S-CCPCH	No	#0	15

**Tables**

Tables are made up of a header, which normally contains the column labels, and lines containing the text.

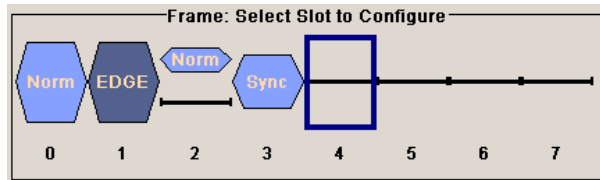

**Graphical display**

Graphical displays show signal characteristics and in some of them the element to be set can be selected.



**Buttons**

The buttons either trigger a single action (e.g. **Execute Single Sweep**), or call the next menu level (to be identified by 3 dots, e.g. **Markers...**).

Some menus contain buttons that assign a function to the front-panel softkey below. These menus cover the Winbar..

## Graphical Display of Output Signal Characteristics

The graphical display of the output signal enables the user to rapidly check signal characteristics without connecting an analyzer. Zoom functions and the display of a reference trace allow in-depth evaluation. The diagram is displayed on top of the block diagram. It can be minimized and called in the same way as a menu.

Example: I/Q diagram

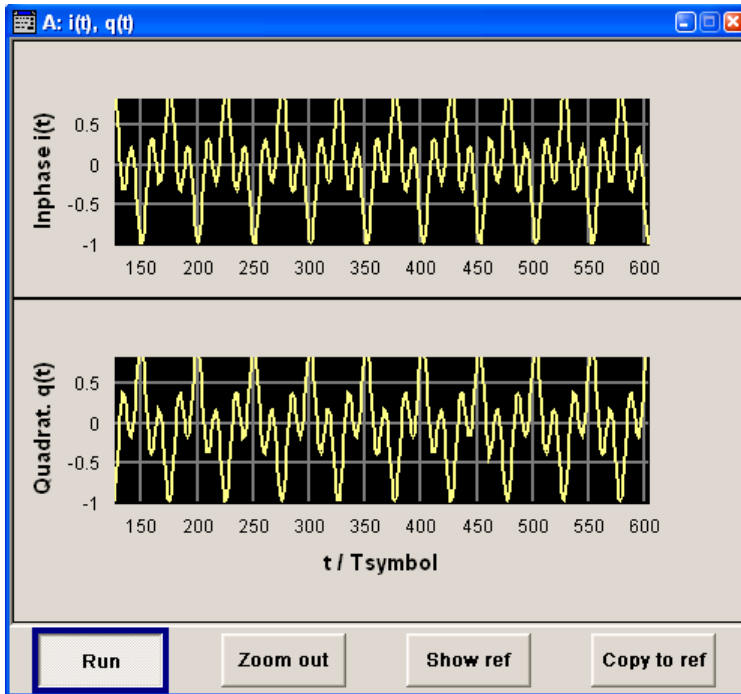

The **Graphics Settings** menu for selecting the graphics display of the output signal can be called either via the **Graphics** function block in the diagram or with the aid of the CTRL+M key combination. Operation of the graphics windows is analogous to menu operation. The menu and the individual graphical displays are described in chapter 4, section ><Graphics Display - Graphics".

## Setting Parameters

The R&S SMATE offers several and sometimes alternative possibilities for setting parameters. Manual operation is possible with the aid of a mouse and/or from an external keyboard. Operation of the R&S SMATE with the aid of these control media is shown in the tables below.

Frequency and level are directly set in the header area of the display using the CTRL+F and CTRL+L key combinations.

Some of the key combinations trigger a direct action, e.g. the CTRL+R key combination switches the RF output on and off. An overview of key functions can be found at the start of this chapter (see section "[Legend of Manual Controls](#)", page 3.1), a detailed description of key functions is given in chapter 4.

Most of the parameters are set in the menus. Menus can be opened from the function blocks of the diagram either with the aid of the external keyboard or by a mouse click on the **Config...** button. An exception are the **Setup** and **File** menus. In the **Setup** menu, general settings are made which are not directly concerned with signal generation, e.g. setting of the IEC/IEEE-bus address. In the **File** menu, files and lists are managed. These menus can only be called with the CTRL+E (setup) and CTRL+S (File) key combinations.

Specific settings can also be made directly in the block diagram, e.g. activating a function block by means of the CTRL+T key combination. Changes affecting the signal flow are immediately visible in the graphics display.

The R&S SMATE uses the WindowsXP® operating system. Settings at system level are only rarely required, e.g. installation of a new printer driver. For operation of WindowsXP®, a keyboard and a mouse are required, the operating system can not be accessed via remote control.

## Calling a Menu - Setting Parameters

After instrument switch-on, the cursor is always on the first function block of the diagram (default setting). It can be moved by means of the cursor keys. The Enter key opens the menu associated with the function block. The CTRL+M key combination opens the complete menu tree.

With the aid of the appropriate key combinations, the cursor can also be moved to the header area or the Winbar.

- CTRL+F and CTRL+L activate the frequency or level entry fields in the header area.
- CTRL+D moves the cursor back to the block diagram.
- CTRL+W moves the cursor to the Winbar. The button that was active last in the Winbar is highlighted. The associated menu is activated with Enter. If the Winbar was covered, it is now displayed in the foreground.
- CTRL+M opens the complete menu tree
- The cursor can also be moved with the ESC key. However, the function of this key depends on the current cursor position:

Parameter field (editing mode):

The editing mode is terminated and the previous value is restored.

Menu area: The cursor is set to another menu area.

Menu: The menu is closed and the cursor changes to the next higher control level.

Frequency/level field:

The cursor is set on the previously active menu or, if no menu was active, on the first function block in the diagram.

Function block in the diagram:

The cursor is set on the first menu in the Winbar. If no menus are open, the current cursor position remains unchanged.

Function	PC keyboard	Mouse
<b>Edits the frequency or level in the entry fields of the header area</b>	Press CTRL + F (frequency) or CTRL + L (level).  Enter value.	Click the entry field and enter value.
<b>Activates the block diagram</b>	Press CTRL + D.	Click the function block.
<b>Activates the Winbar</b>	Press CTRL + F1... F8  Press CTRL + W.	Click button in Winbar.
<b>Calls the Setup or File menu or the menu tree</b>	Press CTRL + S (Setup), CTRL + F (File) or CTRL + M (menu tree).	-

## Selecting a Control Element - Setting Parameters

Control elements are always selected in the same way no matter whether a function block in the diagram, a menu in the menu tree, a parameter in the menu or an entry in a list or table is concerned.

- An element is activated by means of the cursor. An active element is highlighted by a blue frame.



Function	PC keyboard	Mouse
Selects an element	Select element by means of the cursor keys.	Click element.

## Switching Parameters On/Off - Setting Parameters

A parameter can be activated and deactivated using a button or a check box.

- The ENTER function of the different control media switches the highlighted element on or off (toggle function). Colour and label of a button change, the check box is ticked or the tick is removed.



Function	PC keyboard	Mouse
Switches on/off	Press Enter key.	Click check box or button.

## Selecting and Exiting a Menu Area - Setting Parameters

Some menus are organized in areas. The cursor can be moved either only within an area or between the higher-level menu areas. This applies to the **File Select** menus when files are saved or loaded. When the menu is called, one of the menu areas is highlighted by a blue frame.

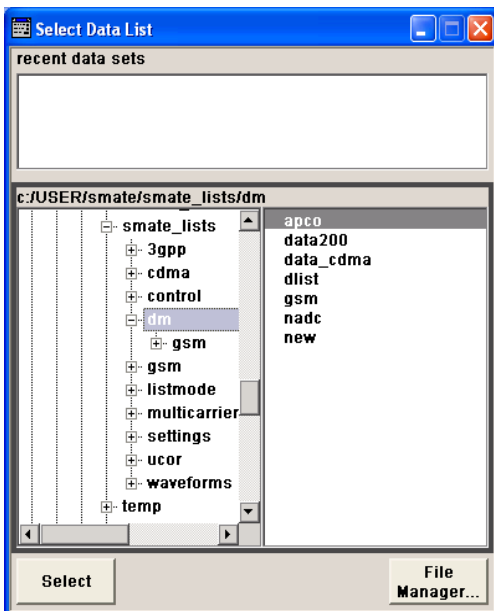

- Another menu area can be selected (highlighted) by means of the cursor keys.
- Clicking the Enter key moves the cursor to the highlighted menu area. When the cursor is placed on a lower-level area in the menu, the area is highlighted by a grey frame. The currently selected item is printed on a blue background (in the example the selected directory). The cursor keys up/down move the cursor only within the grey-framed area.

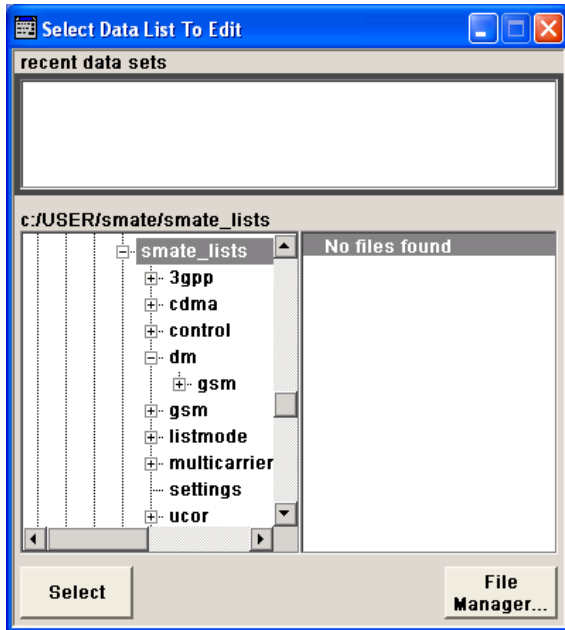

- Enter terminates the setting, i.e. selection of a file. The cursor is either set on the next higher menu level or the menu is closed as in our example.
- The left/right cursor keys first shift the entry focus within the menu range from left to right (or vice versa); in the example, from the directory tree to the file list. Press again and the entry focus is shifted up one menu level. Enter performs a setting. In the example of the **File Select** menu, this is the display of the subdirectories if a directory is marked and, if a file is marked, the selection of this file. After a file has been selected, the menu closes automatically. The ESC key moves the cursor to the next higher menu level.

Function	PC keyboard	Mouse
<b>Selects a menu area</b>	Select menu area using the cursor keys. Press the Enter key.  The cursor keys up/down move the cursor only within the selected menu area.	- (The menu area is selected by selecting an entry.)
<b>Exits a menu area</b>	Press the Enter key.  The cursor keys move the cursor between different menu areas.	- (The menu area is exited by setting the cursor on an item outside the area).

## Entering a Value - Setting Parameters

Numeric and alphanumeric values can be edited in the entry fields. In the editing mode, cursors of different colour are used. A blue cursor indicates the overwrite mode, a green cursor the insert mode. The INSERT key toggles between the two modes. The insert mode is the default setting.

Numeric values can either be newly entered or the existing value can be varied. Incorrect entries are cleared with the BACK SPACE key.

- **Entering a new value:**

Pressing a numeric key activates the editing mode. The previous value is cleared and the new value can be entered.

Symbol Rate 270.833 33 ksym/s

Symbol Rate 4 ksym/s

- **Editing a value in the insert mode (default setting):**

Pressing the Enter key activates the editing mode. Set the cursor to the left of the number to be changed using the left/right cursor keys. The cursor is displayed in green. A change to the overwrite mode is possible any time. In this case the cursor changes its colour and the number to be replaced is highlighted. If the cursor is placed at the right of the total value, the insert mode is always active.

Symbol Rate 270.833 33 ksym/s

Symbol Rate 270.823 333 ksym/s

Symbol Rate 270.823 33 ksym/s

Symbol Rate 270.863 33 ksym/s

- **Editing a value in the overwrite mode:**

Pressing the Enter key activates the editing mode. Set the cursor on the number to be varied using the left/right cursor keys. In the overwrite mode, the cursor is blue. The highlighted value is overwritten by pressing a numeric key.

Symbol Rate 270.833 33 ksym/s

Symbol Rate 4 ksym/s

- **Variation:**

Pressing the Enter key activates the editing mode. Set the cursor to the left of the number to be changed using the left/right cursor keys. The value at the cursor position is varied. An increase or decrease of the value depends on the cursor used (up/down) or on the direction of rotation of the rotary knob.

Symbol Rate 270.833 33 ksym/s

Symbol Rate 250.833 33 ksym/s

Alphanumeric values can either be newly entered or existing values can be edited (e.g. file name).

- **New entry:**

The entry is started by clicking a numeric key.

File Name:

File Name: f



**Editing:**

An existing value, e.g. a file name, can be changed in the insert mode (see example) or in the overwrite mode.



Function	PC keyboard	Mouse
Enters a new value	Press a letter key or a numeric key.	-
Edits a value	Press the Enter key. Select the desired numeric digit using the left/right cursor keys. Enter new value using the letter or numeric keys.  Use the Insert key to toggle between the insert and the overwrite mode.	Click the desired position to set the cursor. Change the value using the keyboard.
Varies a value	Press the Enter key. Select the desired numeric digit using the left/right cursor keys. Vary the number using the up/down cursor keys.	-

### Selecting a Unit - Setting Parameters

The entry of a numeric value can be terminated by pressing a unit key combination, selecting a unit in the selection field next to the value or by the Enter key. The unit is assigned in different ways:

**Terminating the value entry by pressing an unit key combination**

When the entry is terminated with a unit key combination, the selected unit is assigned to the value. In the example, the ALT+F10 key combination assigns Msym/s to the entered value 14.

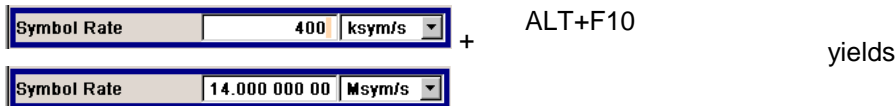

**Terminating the value entry by selecting a unit in the units field**

When the entry is terminated by selecting a unit in the units field next to the value, the selected unit is assigned, e.g. sym/s (for list selection see next section).

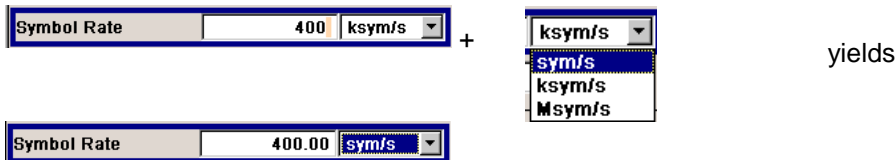

**Terminating the value entry with Enter**

If an entry is terminated with the ENTER key, the unit displayed in the entry field next to the value is assigned (in the example ksym/s).



If a unit is subsequently changed, i.e. after the entry has been terminated and when the editing mode is not active, the value remains unchanged but the display is automatically adapted to the new unit. This applies if the unit is changed by means of the unit key combinations or via the unit field next to the value.



+ ALT+F10 or

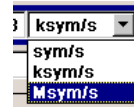

yields

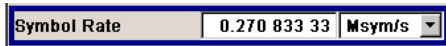





Function	PC keyboard	Mouse
<b>Assigns a unit</b>	To terminate the entry press one of the key combinations ALT + F9/ + F10/+ F11/+ F12 or select unit in the field at the right of the value (for list selection see next section).	Select unit in the field at the right of the value <b>before</b> entering the value (for list selection see next section).
<b>Changes a unit</b>	After the value entry has been terminated press one of the key combinations ALT + F9/+ F10/+ F11/+ F12 or select unit in the field at the right of the value (for list selection see next section).	Select unit in the field at the right of the value <b>after</b> the value entry (for list selection see next section).

## Selecting a Value from a List - Setting Parameters

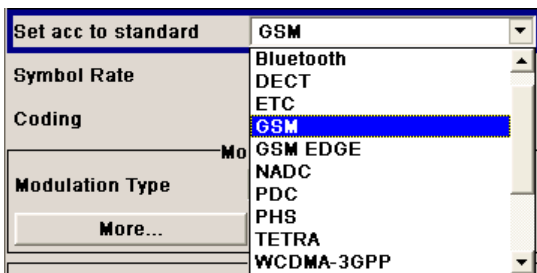
The  button next to the value field indicates that a selection list is available.

- Pressing the Enter key opens the list. Selection is made by choosing an entry (item is highlighted) and confirmation with ENTER. If the list is longer than the displayed window, a scroll bar is available



Function	PC keyboard	Mouse
<b>Opens the selection list</b>	Press Enter key.	Click  button.
<b>Selects an entry</b>	Select entry using the up/down cursor keys and confirm with the Enter key.	Double-click the desired entry.
<b>Scrolls</b>	Shift the displayed list section using the up/down cursor keys.	Press  or  button in the scroll bar until the desired entry is displayed.

## Terminating Entries - Setting Parameters

Variations by means of the cursor keys are immediately set, e.g. RF frequency variation. All other parameter settings have to be confirmed by a pressing the Enter key or one of the unit key combinations (see also section "[Selecting a Unit](#)", page 3.21).

Some settings require additional confirmation. This is the case when it is useful to first enter a few values and to confirm them together, e.g. when a sine test signal is defined in the ARB menu. The signal is only output after confirmation by **Generate Signal**.

All settings of instrument functions that can be switched on and off are calculated and effective only after this function has been switched on.

This applies to most settings on the R&S SMATE. An exception is, for instance, the frequency variation of the reference oscillator, which is immediately set after confirmation.

Calculation and setting may take up different periods of time. Many settings are made without noticeable calculation times. If a short period is required, **BUSY** is displayed during this time in the status field of the header section. If more time is required for calculation, a window with a progress bar is displayed. Calculation can be aborted with the **Abort** button in this window.

If time-consuming calculations are required, signal generation is automatically switched off and calculation is interrupted to allow the user to make further settings. Calculation is restarted with the CTRL+C key combination and the modulation is switched on again when the calculation is completed.

**Hint:** *If several settings are to be made for an instrument function, recalculation of the signal can be prevented by switching the function off. When the function is switched on again after all parameter have been changed, the signal is recalculated only once.*

Function	PC keyboard	Mouse
<b>Accepts value immediately</b>	Vary the value with the up/down cursor keys.	-
<b>Confirms entries</b>	Press Enter key or one of the key combinations ALT + F9/+ F10/+ F11/+ F12.	Exit entry field.
<b>Confirms entries in the menus with the <b>Accept</b> button.</b>	Select <b>Accept</b> button with the cursor keys and press Enter.	Click <b>Accept</b> button.
<b>Sets the entries in the instrument</b>	If the instrument function is active, the new value is immediately calculated and set.  If the instrument function is not active, the new, confirmed value is calculated and set only when the function is switched on.	(see keyboard)

## Restoring the Previous Value - Setting Parameters

Parameter variations with the cursor keys are immediately set and therefore not reversible. Normally, values cannot be restored also in the case of mouse control because no explicit confirmation is required in this case and entries are automatically confirmed when the entry or selection field is exited.

In the case of operation from the keyboard, previous values can be restored as long as the new value is not confirmed, i.e. the entry is not completed. This can be done with the ESC key.

With settings requiring an additional confirmation, all settings are aborted when the ESC key is pressed. Before the changes are aborted, a confirmation query is displayed. If **OK** is clicked, the changes are aborted; if **Cancel** is clicked, the menu with the previous settings is displayed again.

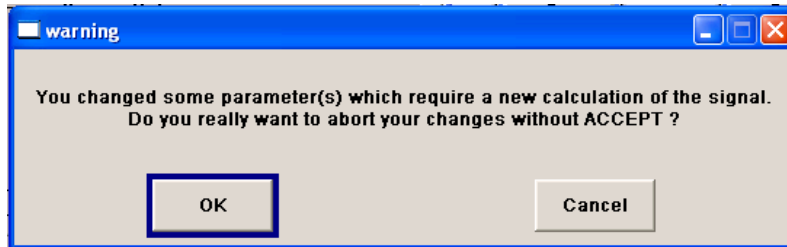

When a window with a progress bar is displayed in the case of extended calculations, the calculation can be terminated with the **Abort** button. In this case all previous values are restored.

Function	PC keyboard	Mouse
Restores previous values	Press the Esc key before the entries are confirmed.	-
Restores all previous values in menus with <b>Accept</b> button	Press the Esc key. Answer the confirmation query with OK (see above).	Click the  button. Answer the confirmation query with OK (see above).
Restores all previous values after an extended calculation has been started	Select the <b>Abort</b> button in the progress bar using the cursor keys and press the Enter key.	Click the <b>Abort</b> button.

## Menu Operation

Menus are operated with the aid of the Winbar buttons and with key combinations.



If the Winbar is covered by a menu, it can be called to the front with the CTRL+W key combination.

- The CTRL+D key combination moves the cursor to the block diagram. All active menus are minimized and displayed in the form of Winbar buttons.
- The CTRL+H key combination minimizes an active menu. It is displayed in the form of a Winbar button.
- The CTRL+F1 to F8 key combinations maximize the corresponding menu.
- The CTRL+G key combination closes an active menu.
- The CTRL+W key combination toggles the cursor between a Winbar button and the block diagram.
- The softkeys call or close the associated menu and set the cursor in the menu.

---

**Note:**     *The ESC key also closes the active menu if the cursor is at the highest menu level.*

---

Function	PC keyboard	Mouse
<b>Displays the block diagram in the foreground</b>	Press CTRL + D.	Click function block.
<b>Displays a menu in the foreground</b>	Press CTRL + F1 to F8.	Click the respective button in the Winbar.
<b>Minimizes an active menu</b>	Press CTRL + H.	Click the  button in the menu bar.
<b>Closes an active menu</b>	Press CTRL + G.	Click the  button in the menu bar.
<b>Hides all menus</b>	Press CTRL + D.	-
<b>Automatically arranges displayed menus</b>	-	- The menus can be shifted with the mouse as required. The frequency and level fields and the info line cannot be covered, however.

## Editors

The R&S SMATE provides user-friendly editors for defining data lists as well as control and marker signals. Lists containing frequency and level value pairs are used for the list mode and the user-defined level correction. Internally generated data lists can be used for digital modulation and digital standards; the same applies to internally defined control and marker signals.

The lists are saved to files and may thus have any length. The file name of the lists and the directory to which the files are saved are user-selectable. The file prefix is different for each list type and is permanently assigned by the system (see section "[File Management](#)", page 3.34).

### List Editor

The **User Correction** and **List Mode** menus provide the list editor for defining the frequency/level value pairs. The associated buttons call up the list editor.

Edit User Correction Data...

Edit List Mode Data...

- The selected list is displayed. If no list has been selected, a blank list of only one row is displayed.

The screenshot shows a window titled "Edit List Mode Data lista1". It contains a table with two columns: "Frequency / Hz" and "Power / dBm". The table has 10 rows, numbered 1 to 10. Below the table are four buttons: "Goto", "Insert Row(s)", "Save As...", and "Save".

	Frequency / Hz	Power / dBm
1	1 000 000 000.00	0.25
2	1 000 000 000.00	0.24
3	1 000 000 000.00	0.23
4	1 000 000 000.00	0.22
5	1 000 000 000.00	0.21
6	1 000 000 000.00	0.20
7	1 000 000 000.01	0.19
8	1 000 000 000.00	0.18
9	1 000 000 000.00	0.17
10	1 000 000 000.00	0.16

- The value pairs are entered in the **Frequency/Hz** and **Power/dBm** table columns. A blank row is inserted at the end of the list.
- New rows can be inserted anywhere in the table by means of the **Insert Row(s)...** button.
- After the list has been edited, i.e. changed, it can be saved under its current name by means of the **Save** button, or under a new name by means of the **Save as...** button. Only complete value pairs are taken into consideration; rows containing an entry in only one column are ignored.
- An existing list can be edited in the insert or overwrite mode.
- A new list can be created under a new name either by generating a blank file in the **File Select** menu (see section "[File Management](#)", page 3.34) or by changing an existing list which will then be saved under a new name.

Function	PC keyboard	Mouse
<p><b>Call up editor.</b></p> <p>The cursor marks the first row of the Frequency/Hz column.</p>	Mark the <b>Edit xxx Data...</b> button in the individual menu and press the Enter key.	Click the <b>Edit xxx Data...</b> button in the individual menu.
<p><b>Enter value.</b></p>	Use the numeric keys to enter the value and terminate the entry by pressing the Enter key.	-
<p><b>Change column.</b></p>	Press the left/right cursor keys.	Click cell.
<p><b>Change row.</b></p>	Use the up/down cursor keys to mark the row.	Click cell.
<p><b>Select row.</b></p> <p>The cursor moves to the selected row.</p>	<p>Mark the <b>GoTo</b> button and press the Enter key.</p> <p>Use the numeric keys to enter the row index and terminate the entry by pressing the Enter key.</p>	Click cell.
<p><b>Insert row.</b></p> <p>A row is inserted above the currently marked row.</p> <p>If no row has been selected, a row is inserted at the beginning of the list.</p>	<p>Select the row above which the new row is to be inserted.</p> <p>Mark the <b>Insert Row(s)</b> button and press the Enter key.</p>	<p>Click the row above which the new row is to be inserted.</p> <p>Click the <b>Insert Row(s)</b> button.</p>
<p><b>Save list under a new name.</b></p>	<p>Mark the <b>Save as..</b> button and press the Enter key.</p> <p>Enter the file name in the <b>File Select</b> menu and select the directory (see section "<a href="#">File Select Menu</a>", page 3.36)</p>	<p>Double-click the <b>Save as...</b> button.</p> <p>Enter the file name in the <b>File Select</b> menu and select the directory (see section "<a href="#">File Select Menu</a>", page 3.36)</p>
<p><b>Save list under the same name.</b></p>	Mark the <b>Save</b> button and press the Enter key.	Double-click the <b>Save</b> button.
<p><b>Create new list.</b></p>	<p>Mark the <b>List Mode Data</b> or <b>User Correction Data</b> button and press the Enter key.</p> <p>Mark <b>Create New List</b> and press the Enter key.</p> <p>Enter the file name in the <b>File Select</b> menu and select the directory (see section "<a href="#">File Select Menu</a>", page 3.36)</p>	<p>Double-click the <b>List Mode Data</b> or <b>User Correction Data</b> button.</p> <p>Double-click <b>Create New List</b>.</p> <p>Enter the file name in the <b>File Select</b> menu and select the directory (see section "<a href="#">File Select Menu</a>", page 3.36)</p>

## Data Editor

The **Data Editor** can be used to internally generate binary data lists for digital modulation and digital standards.

A list of binary values with a maximum length of  $2^{31}$  bits can be entered in the **Data Editor**. This value corresponds to a file size of approx. 268 Mbyte. While it is being processed, the file is continuously automatically buffered. When the menu is exited, the file is automatically saved with the new values, i.e. there is no extra **Save** button. Depending on the size of the file, saving may take some time.

It is called up in the individual menus by means of the **Edit Data List...** button.

- The selected data list is displayed.

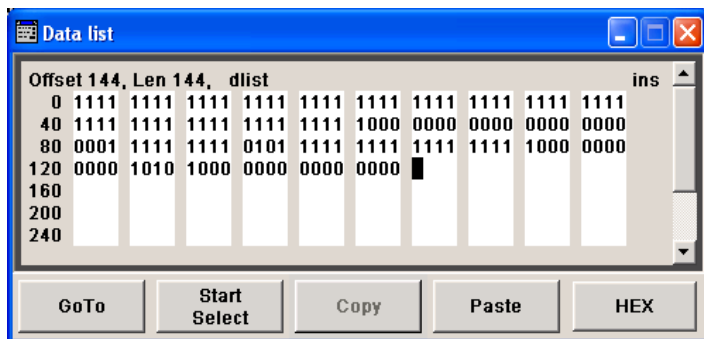

- To increase readability, the bits are displayed in groups of four. The current cursor position, the length of the list and the list file name are displayed above the list. The offset starts with the value 0 which corresponds to the bit position on the left side of the first row, i.e. the beginning of the list. On the left edge of the editor, the last three offset positions are specified at the beginning of the row.
- An existing list can be edited in the insert or overwrite mode.
- By means of the **GoTo** button, any bit position can be accessed.
- By means of the **Start Select**, **Copy** and **Paste** buttons, any range of bits can be marked, copied and subsequently pasted at any position in the list.
- By means of the **HEX** button, switchover to hexadecimal display is possible.
- For a new list to be edited, it must first be created in the **File Select** menu (see section "[File Management](#)", page 3.34) and then selected.

Function	PC keyboard	Mouse
<p><b>Call up editor.</b></p> <p>The cursor marks the start value of the list.</p>	<p>Mark the <b>Edit Data List...</b> button in the list management submenu of the individual menu and press the Enter key</p>	<p>Click the <b>Edit Data List...</b> button in the list management submenu of the individual menu.</p>
<p><b>Enter value.</b></p> <p>Depending on selected mode, either insertion or overwrite, the value is either inserted or it replaces an existing value.</p>	<p>Use the numeric keys to enter the values 0 or 1.</p>	<p>-</p>



Function	PC keyboard	Mouse
<p><b>Delete value.</b></p> <p>The value before the marked bit is deleted.</p>	<p>Use the cursor keys to mark the bit that follows the value to be deleted.</p> <p>Press the Insert key to activate the insertion mode. Values cannot be deleted in the overwrite mode.</p> <p>Press the Backspace key.</p>	-
<p><b>Select bit position.</b></p> <p>The cursor marks the bit at the selected position.</p>	<p>Mark the <b>GoTo</b> button and press the Enter key.</p> <p>Use the numeric keys to enter the bit position in the <b>Offset</b> entry field and terminate the entry by pressing the Enter key.</p>	Click bit.
<p><b>Copy and paste bits.</b></p> <p>The selected and copied bits are pasted after the selected position.</p>	<p>Move the cursor to the start of the selection.</p> <p>Press the ESC key. Mark the <b>Start Select</b> button and press the Enter key.</p> <p>Move the cursor to the end of the selection.</p> <p>Press the ESC key. Mark the <b>Copy</b> button and press the Enter key.</p> <p>Move the cursor to the insert position.</p> <p>Press the ESC key. Mark the <b>Paste</b> button and press the Enter key.</p>	<p>Click the bit at the start of the selection.</p> <p>Click the <b>Start Select</b> button.</p> <p>Click the bit at the end of the selection.</p> <p>Click the <b>Copy</b> button.</p> <p>Click the bit position after which the copied bits should be pasted.</p> <p>Click the <b>Paste</b> button.</p>
<p><b>Display and edit the values in hexadecimal form.</b></p> <p>Each four bits are displayed as a hexadecimal value: To increase readability, the hexadecimal values in turn are displayed in pairs of two. The hex functions are automatically assigned to the numeric keys at the front panel.</p>	<p>Mark the <b>Hex</b> button and press the Enter key.</p>	Click the <b>Hex</b> button.
<p><b>Save list.</b></p> <p>The list is saved automatically when the menu is closed.</p>	<p>Press the ESC key.</p>	Click the  button in the menu bar.
<p><b>Create new list.</b></p>	<p>Mark the <b>Data List..</b> button in the list management submenu of the individual menu and press the Enter key.</p> <p>Mark <b>Create New List</b> and press the Enter key.</p> <p>Enter the file name in the <b>File Select</b> menu and select the directory (see section "<a href="#">File Select Menu</a>", page 3.36)</p>	<p>Double-click the <b>Data List..</b> button in the list management submenu of the individual menu.</p> <p>Double-click <b>Create New List</b>.</p> <p>Enter the file name in the <b>File Select</b> menu and select the directory (see section "<a href="#">File Select Menu</a>", page 3.36)</p>

## Control and Marker List Editor

The control and marker signals for digital modulation and digital standards can be very conveniently graphically defined in a **Control and Marker List Editor**.

The four available marker signals – and, with custom digital modulation, the CW, Hop, Burst Gate and Lev Att control signals – can be defined in the **Control and Marker List Editor**. While it is being processed, the file is continuously automatically buffered. When the menu is exited, the file is automatically saved with the new values, i.e. there is no extra **Save** button. Depending on the size of the file, saving may take some time.

The **Control List Editor** is called up in the Custom Digital Mod menus by means of the **Edit Control List...** button.

The **Slot Marker Definition** Editor is called up in the Burst submenu of the GSM/EDGE menus by means of the **Slot Marker Definition...** button.

The following figure shows the **Slot Marker Definition** Editor of the GSM/EDGE menu as an example.

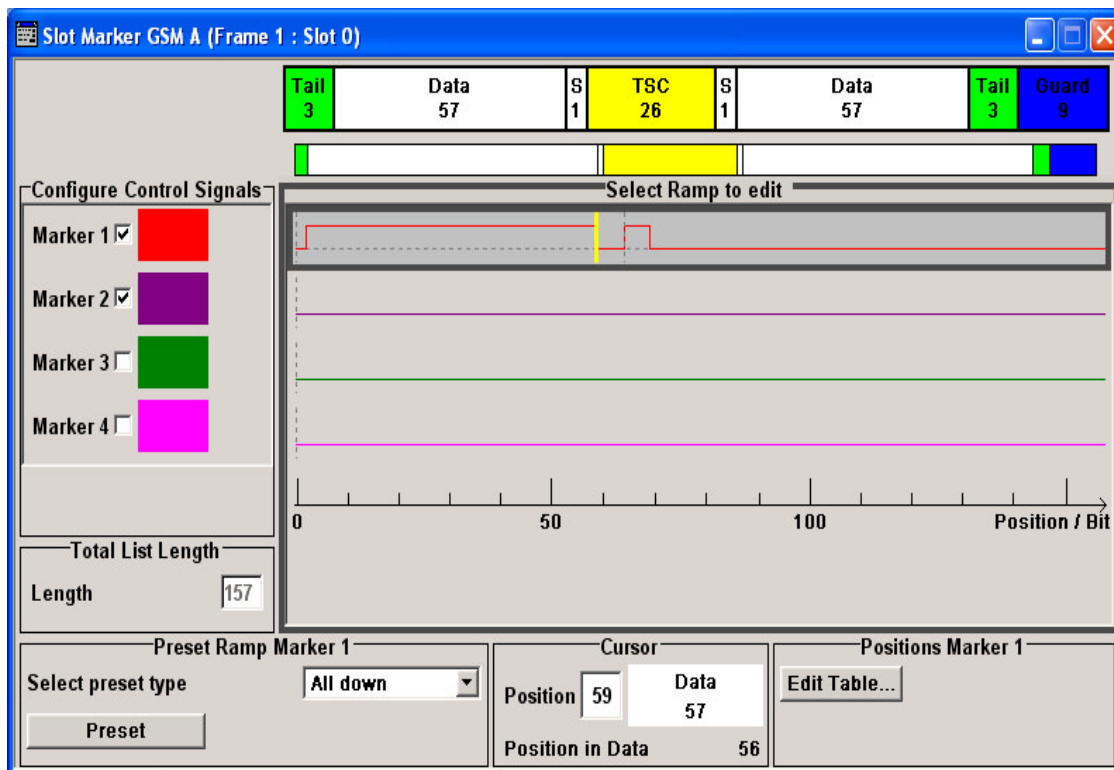

- The upper area displays the signal (in the example, the GSM slot) for which the marker signals are to be defined. On the left side, the available signals (marker and control signals) are listed and colour-coded.
- Auxiliary functions are offered in the lower editor area, e.g. presettings for the ramps in the marker signal, cursor positioning by entering the bit position and possible editing by means of value entries in a table.
- The actual graphic definition of the control signals occurs in the center area of the editor. Each control signal is represented by means of a coloured line along the bit axis. A cursor can be shifted alongside this line and marks the position where a ramp is to be set.

The color of the cursor changes depending on the current function. The switch over between the colors (and therefore functions) is by means of the Enter key:

- black: marks the bit position on the marker line
- yellow: sets a ramp
- green: activates the marked ramp for shifting

The ramp transition of the newly set ramp depends on the current status (high/low) of the control signal. If the signal is low, a ramp with low/high transition is generated; if the signal is high, a ramp with high/low transition is generated.

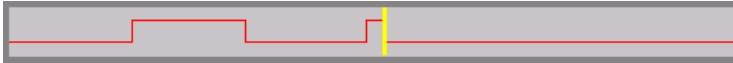

When ramps are set between existing ramps, the transition of the new ramp is also defined by the status of the signal before the new ramp. For this reason, a ramp that has already been set can be assigned low/low or high/high transition (as in the example), i.e. it will have no effect on the control signal in this configuration. However, the ramp remains saved, and its position is indicated by a dashed line.

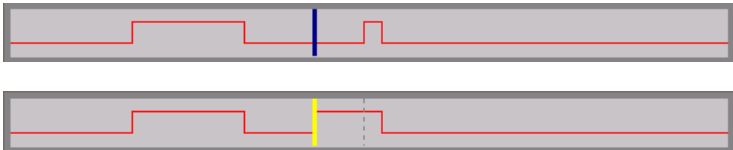

If another change produces effective transition, this ramp will be regenerated.

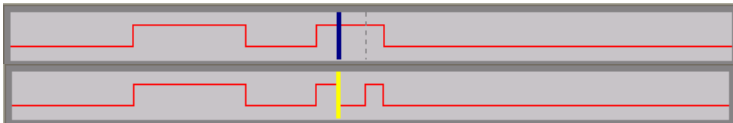

- An existing ramp can be shifted to any positions. The transitions are adjusted accordingly.



- To make the setting easy, a selection of preset ramp characteristics is offered in the **Preset Signal** area.
- In the **Cursor** area, the cursor can be specifically set to a defined bit position in the data signal.
- The ramps can also be set in the table in the **Marker Positions** area.

The various functions of the editor are explained in the individual menus. The following table explains only the general use of the graphic editor.

Function	PC keyboard	Mouse
<p><b>Call up editor.</b></p> <p>The cursor marks the first control signal in the list on the left side of the menu.</p>	<p>Mark the button in the individual menu and press the Enter key.</p>	<p>Click the button in the individual menu.</p>

Function	PC keyboard	Mouse
<p><b>Activate control/marker signal line for editing</b></p> <p>The cursor is active for the selected line.</p>	<p>Use the cursor keys to mark the editable graphic area and press the Enter key.</p> <p>Use the cursor keys to mark the control/marker signal line and press the Enter key.</p>	Click row.
<p><b>Set ramp.</b></p> <p>The ramp transition depends on the status (high/low) of the control/marker signal before the ramp.</p>	Use the cursor keys to move the cursor to the position where the ramp is to be inserted. Press the Enter key.	Double click cursor; the cursor changes colour and the ramp is inserted.
<p><b>Shift ramp.</b></p> <p>The ramp transition depends on the status (high/low) of the control/marker signal before the ramp.</p>	<p>Use the cursor keys to move the cursor to the ramp position; the cursor changes colour.</p> <p>Press the Enter key. The cursor again changes colour. The ramp will now be shifted by means of the cursor.</p> <p>Press the Enter key. The ramp will be set at the current position.</p>	<p>After double-clicking the cursor, click it once again and, while holding down the left-hand mouse button, drag it. The cursor changes colour.</p> <p>The ramp is set as soon as the left-hand mouse button is released.</p>
<p><b>Delete ramp.</b></p> <p>The ramp transitions of the other ramps are adapted to the changed signal status (high/low).</p>	<p>Use the cursor keys to move the cursor to the ramp position; the cursor changes colour.</p> <p>Press the Delete key. The ramp will be deleted.</p>	-
<p><b>Define length of control list (Custom Dig Mod only).</b></p>	<p>Use the cursor keys to mark the <b>Length</b> entry field in the <b>Cursor</b> menu area and press the Enter key.</p> <p>Enter the length by means of the numeric keys.</p> <p>Press the Enter key. The control list length is defined.</p>	-
<p><b>Zoom displayed range (Custom Dig Mod only).</b></p> <p>Approx. 300 bits around the current cursor position are displayed.</p>	<p>Use the cursor keys to mark the <b>Zoom in</b> button and press the Enter key.</p> <p>Enter the length by means of the numeric keys.</p> <p>Press the Enter key. The control list length is defined.</p>	Click the <b>Zoom in</b> button.
<p><b>Save list.</b></p> <p>The list is saved automatically when the menu is closed.</p>	Press the ESC key.	Click the  button in the menu bar.
<p><b>Create new list (Custom Dig Mod only).</b></p>	<p>Mark the <b>Control List...</b> button in the list management submenu of the individual menu and press the Enter key</p> <p>Mark <b>Create New List</b> and press the Enter key.</p> <p>Enter the file name in the <b>File Select</b> menu and select the directory (see section "<a href="#">File Select Menu</a>", page 3.36)</p>	<p>Double-click the <b>Control List...</b> button in the list management submenu of the individual menu.</p> <p>Double-click <b>Create New List</b>.</p> <p>Enter the file name in the <b>File Select</b> menu and select the directory (see section "<a href="#">File Select Menu</a>", page 3.36)</p>

## Help System

The R&S SMATE is equipped with a context-sensitive help function. A help page is available for each parameter and can be called any time during instrument operation. The context-sensitive page which is opened with the F1 key is part of a comprehensive help system. It is possible to move from this context-sensitive page to any page of the help system.

**Note:** *Compiled online help systems are also available for all functions of the R&S SMATE on the CD-ROM supplied with the instrument. This help program can be called on any controller with Internet Explorer version V 4.0 and higher.*

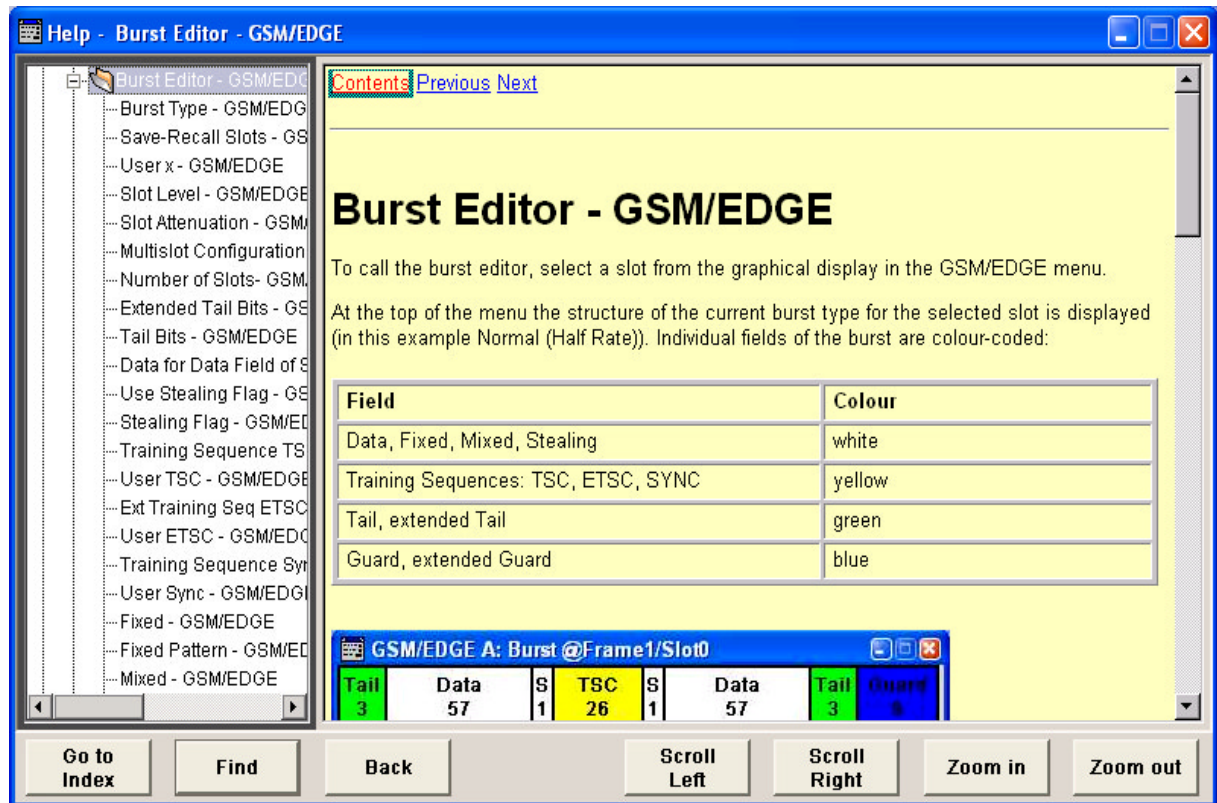

The help function is provided with a navigation bar, i.e. other help pages can be called from the context-sensitive page via the table of contents, the index, arrows for scrolling and page-internal links.

### Operation of context-sensitive help

Function	PC keyboard	Mouse
<b>Open the help system</b>  The help page for the respective parameter is displayed.	Press F1 key.	-
<b>Close the help system</b>	Press F1 key again.	-

Function	PC keyboard	Mouse
<b>Activate the link</b> The help system branches to the linked page.	Select link using the cursor keys and activate with the Enter key.	Click link.
<b>Scroll</b>	Select <b>Previous</b> or <b>Next</b> in the help window using the cursor keys and activate with the Enter key.	Click <b>Previous</b> or <b>Next</b> .
<b>Select an item in the table of contents</b> The help page of the item is displayed.	Activate Content window using the cursor keys left/right. Select the desired item using the cursor keys and activate with Enter.	Set indicated area by moving the vertical scroll bar. Click item.
<b>Select an index term</b> The help page of the term is displayed.	Select the <b>Go-to-Index</b> button using the cursor keys and activate with the Enter key. Enter the first letter of the term and press the Enter key. Select the term with the cursor keys and press the Enter key.	Click the <b>Go-to-Index</b> button. Set indicated area by moving the vertical scroll bar. Click term.
<b>Shift the indicated area of the navigation window to the left or right</b>	Shift the entry focus up one level using the Esc key. Select <b>Scroll Right</b> or <b>Scroll Left</b> - button using the cursor keys and activate with the Enter key.	Set indicated area by moving the horizontal scroll bar.

## File Management

The R&S SMATE uses files to save all instrument data, i.e. system and user data. The user data includes saved instrument settings, data for the different digital standards, lists for the List mode and the user correction as well as the waveforms for multicarrier CW generation and the arbitrary waveform generator.

The files are stored on the hard disk of the instrument. Drive D:\ can be used to save user-defined data; any directory structure can be created on D:\. Some default directories are predefined, but can be changed at any time.

The C:\ drive is a protected system drive. The files on this drive contain data that must not be changed. Therefore, this drive should not be accessed, since reconstruction of the system partition will lead to data loss. To prevent inadvertent deletion or overwriting of system files, this drive is not specified in the file menus. It can be accessed if a protection level (see protection level, Setup menu) is revoked.

Files can be exchanged either via a memory stick or a connected network.

A memory stick is connected to the USB interface and is assigned the next free drive.

In the case of a connected network, all network drives that can be accessed are available (see chapter 1, section "[Connecting the R&S SMATE to a Network \(LAN\)](#)", on page 1.20").

The user data can be roughly divided into four data types:

- Settings
- Lists
- Complex modulation and control data
- Waveforms

The files are accessed in a **File Select** window in the individual menus. Depending on the data type, a file can either be selected or it can be selected and saved:

- Settings, e.g. the frame setting of the GSM/EDGE standard, can be loaded and saved. In this case, the current setting is saved to the specified file.



- Lists, e.g. user correction lists, can be loaded. They can be generated either externally or internally. For internal generation, a new list must be created in the **File Select** window which will then be edited in the list editor of the individual menu.



- Complex modulation and control data can be loaded. It can be generated either externally or internally. For internal generation, a new list must be created which will then be edited in the data and control list editor. These functions are offered in the **Data List Management** window of the individual modulation menu.



- Waveforms are generated externally (e.g. by means of the R&S WinIQSIM program that is supplied together with the optional Baseband Generator R&S SMATE-B10/B11) and can be loaded in the **Arbitrary Waveform Generation** menu.



The files are differentiated according to their extensions; each type of file is assigned a specific file content. The extension is usually of no consequence to the user since access to the files occurs in the individual menus where only the relevant type of file is available. For example, files with frame settings can only be saved and loaded in the **GSM/EDGE** menu.

A button in the individual menu calls up the selection of the **Save, Recall** and **File Manager** functions. If the file can only be loaded, the **Select** or **Load** and **File Manager** selection is available.

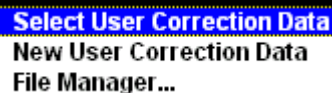
After the **Save/Recall** or **Select/New** selection, a **File Select** window for loading, saving or creating a file is displayed (see the following section "[File Select Menu](#)", page 3.36).

After the **File Manager** selection, a menu for managing all files is displayed (see section "[File Manager](#)", page 3.37).

All instrument settings are saved and loaded in the **File** menu which is called up by means of the CTRL+S key combination (see chapter 4, section "[Storing and Loading Instrument Data – File Key](#)").

## File Select Menu

The **File Select** menu consists of several areas.

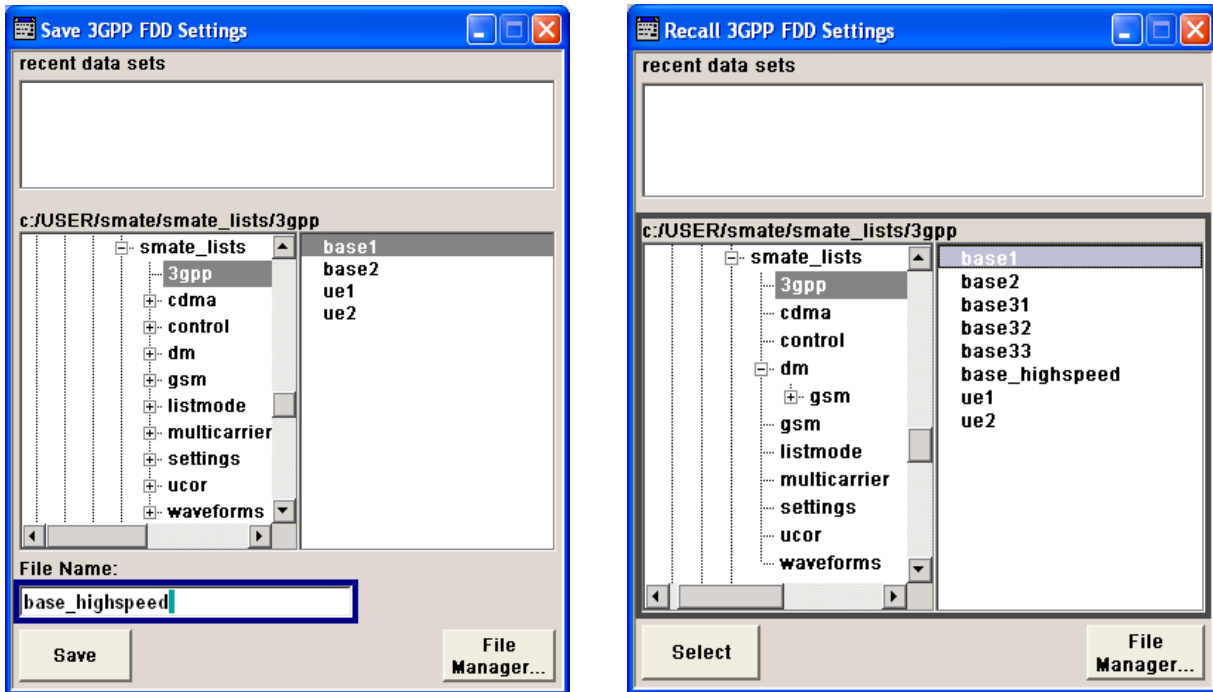

In the upper area, **Recent Data Sets**, the files last used are listed; a maximum of ten files is displayed.

The available drives and directories are displayed on the left side, the files of the selected directory on the right side. The currently selected path is displayed above the windows. Only the relevant files without file extensions are displayed. If the area is opened several times, the path last selected is displayed.

When a file is saved or created, its name is user-selectable; the extension is assigned automatically and cannot be entered. The file is saved to the selected path.

Operation is similar to the operation of menus with several areas (see section "[Selecting and Exiting a Menu Area - Setting Parameters](#)", page 3.18):

By using the cursor keys, the area is marked; the entry focus is shifted to this area by using the Enter key. The up/down cursor keys will then navigate only within this area. By using the left/right cursor keys, it is possible to switch between the directory tree and the file list. The subdirectories of the selected directory will only be displayed after a short delay to allow quick navigation in the directory tree. Pressing the ESC key again shifts the entry focus up one level. The button for saving or loading the file can be selected and pressed. After the setting, e.g. after selecting the file, the menu will be closed automatically.

- **Load file:**  
Select **Recall** in the **Select Operation** list on top of the menu. Mark file in the file list and load it by pressing the Enter key.
- **Save file:**  
Select **Save** in the **Select Operation** list on top of the menu. Enter file name in the **File Name:** field. Mark the directory to which the file is to be saved and then press the Enter key.

In addition to the files saved by the user, some menus also offer files containing predefined contents. These files are saved to a specific directory on system drive C.; for this reason, this directory cannot be chosen from the **File Select** menu. The following example shows the **File Select** menu of the GSM/EDGE digital standard when **Recall Predefined Frames** is selected.



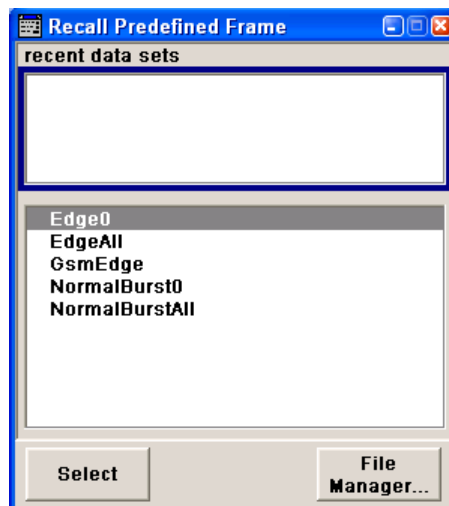

## File Manager

The **File Manager** allows general file management such as copying, shifting, renaming and deleting files as well as generating new directories. Thus, also externally created files, for example waveforms created by using the **R&S WinIQSIM** program, can be saved to the R&S SMATE by copying them from a memory stick or a network to the internal hard disk.

The **File Manager** can be called up in any menu to which files can be saved. Call-up is either at the level of the small selection menu



or via the **File Manager** button in the **File Select** window.



The File Manager can also be called up in the **Save/Recall - Setup-Settings** menu.

In the upper area, **File Type**, the **File Manager** allows the type file selection to be displayed. This can be used to process either all files (all files (\*.\*) selection) or a specific selection of files (e.g. waveforms (\*.vv) selection). The table at the end of this section contains a list of the file types.

The available drives and directories are displayed on the left side, the files of the selected directory on the right side. The currently selected path is displayed above the windows. If the area is opened several times, the path last selected is displayed. Unlike the **File Select** window, the **File Manager** displays the full file names including extensions.

The buttons/softkeys trigger the associated actions such as copying, shifting or deleting the marked files. Plus, a new directory can be created in the level below the marked directory.

Operation is similar to the operation of menus with several areas (see section "[Selecting and Exiting a Menu Area - Setting Parameters](#)", page 3.18): By using the cursor keys, the area is marked; the entry focus is shifted to this area by using the Enter key. The up/down cursor keys will then navigate only within this area. By using the left/right cursor keys, it is possible to switch between the directory tree and the file list. The subdirectories of the selected directory will only be displayed after a short delay to allow quick navigation in the directory tree. Pressing the **[ESC]** key again shifts the entry focus up one level. The buttons/softkeys can be selected and activated.

- Shift file:**  
 Mark file and then press the **Cut** button/softkey. Mark the directory to which the file is to be shifted and then click the **Paste** button/softkey. If the target directory already contains a file with the same name, a confirmation query is displayed to confirm overwriting of this file.
- Copy file:**  
 Mark file and then press the **Copy** button/softkey. Mark the directory to which the file is to be copied and then click the **Paste** button/softkey. If the target directory already contains a file with the same name, a confirmation query is displayed to confirm overwriting of this file.
- Rename file:**  
 Mark file and then press the **Rename** button/softkey. An entry window for entering the new file name opens. Enter the name and press the Enter key. If a file with the same name already exists, a confirmation query is displayed to confirm overwriting of this file.
- Delete file:**  
 Mark file and then press the **Delete** button/softkey. Prior to deletion, a confirmation query is displayed which the user must confirm for this file to be deleted.
- Create new directory:**  
 Mark drive or directory level where the new directory is to be created and then press the **Create New Directory** button/softkey. An entry window for entering the directory name opens. Enter the name and press the Enter key.

Table 3-1 List of file extensions for user files the R&amp;S SMATE assigns automatically

List type	Contents	File suffix
<b>Instrument State</b>		
Instrument State	Instrument settings	*.savrc1
<b>User Correction</b>		
User Correction	User-defined level correction values	*.uco
<b>List Mode</b>		
List	User-defined frequency/level value pairs	*.lsw
<b>Arbitrary Waveform Generator</b>		
Waveform Multi segment waveform	ARB waveforms ARB multi segment waveforms	*.wv
Configuration data	Configuration file for creation of multisegment ARB waveforms	*.inf_mswv
<b>DM</b>		
Data List	Digital modulation data	*.dm_iqd
Control List	Data to control digital modulation	*.dm_iqc
<b>GSM/EDGE</b>		
Slot	User-defined slot data	*.gsm_slu
Frame	User-defined frame data	*.gsm_fu
<b>CDMA2000</b>		
CDMA2000 Settings	Complete setting of the CDMA2000 menu	*.cdma2k
<b>3GPP FDD</b>		
3GPP Settings	Complete setting of the 2GPP (FDD) menu	*.3g
Channel Coding DPCH	Channel coding enhanced DPCH channels (uplink)	*.3g_ccod_ul
Channel Coding DPDCH	Channel coding enhanced DPDCH channels (downlink)	*.3g_ccod_dl

## Contents - Chapter 4 "Instrument Functions"

<b>Instrument Functions .....</b>	<b>4.1</b>
Overview of Instrument Functions.....	4.1
<b>General Instrument Settings .....</b>	<b>4.4</b>
Overview of General Instrument Settings .....	4.4
Default Instrument Settings - Preset Key .....	4.4
General Configuration of Instrument - Setup Key .....	4.5
Internal Adjustments - Setup-System.....	4.6
Hardware Config... - Setup-System.....	4.8
Gui Update... - Setup/System.....	4.9
Software / Options... - Setup/System .....	4.9
Install SW-Option... - Setup/System.....	4.10
Test Point... - Setup-Test .....	4.10
Check Front Panel - Setup-Test.....	4.12
Global Trigger/Clock/External Input Settings - Setup-Environment ..	4.13
User Marker - AUX IO - Setup-Environment-Global...Settings .....	4.16
Remote GPIB - Setup-Remote.....	4.19
Protection - Setup-Protection .....	4.20
Save Recall - Setup-Setting .....	4.20
Help - Setup-Help .....	4.20
Switching to Manual Control - Local Key .....	4.20
Generating a Hardcopy of Display - Hcopy Key.....	4.21
Messages - Info Key.....	4.21
Help System - Help Key .....	4.22
Storing and Loading Instrument Data - File Key .....	4.24
File Menu.....	4.25
Storing Instrument Settings - File .....	4.25
Loading Instrument Settings - File.....	4.27
File Management - File.....	4.28
<b>Graphical Display - Graphics .....</b>	<b>4.30</b>
Graphical Display of Signal Characteristics .....	4.30
Graphics Settings Menu .....	4.31
Softkey Bar of Graphics Window.....	4.33
Signal Displays - Graphics .....	4.36
I/Q Diagram - Graphics .....	4.36
Vector Diagram - Graphics.....	4.37
Constellation Diagram - Graphics .....	4.38
Eye Diagram - Graphics .....	4.39
CCDF Display - Graphics .....	4.40
Power Spectrum - Graphics .....	4.41
<b>RF Signal and Analog Mod - A Mod-RF A .....</b>	<b>4.42</b>
Overview of RF Signal and Analog Modulations.....	4.42
RF Frequency and Phase - Frequency - Phase.....	4.43

Frequency - Phase Menu .....	4.44
RF Reference Frequency - Reference Oscillator .....	4.47
Reference Oscillator Menu .....	4.47
RF Level - Level - EMF .....	4.49
Level - EMF Menu .....	4.50
Automatic Level Control - ALC .....	4.55
Automatic Level Control Menu .....	4.55
Power Sensors .....	4.56
Power Sensors Menu .....	4.57
User Correction .....	4.61
User Correction Menu .....	4.62
List Mode - List .....	4.67
Sweep Mode.....	4.79
Frequency Sweep Menu .....	4.79
Level Sweep Menu.....	4.85
LF Frequency Sweep Menu .....	4.90
LF Generator and LF Output - LF Output.....	4.94
LF Output Menu.....	4.95
Analog Modulations .....	4.96
Modulation Sources.....	4.96
Simultaneous Operation of Several Modulations or Other Operating Modes.....	4.97
Amplitude Modulation - AM .....	4.97
Amplitude Modulation Menu.....	4.98
Broadband Amplitude Modulation - BB-AM .....	4.100
Broadband Amplitude Modulation Menu .....	4.101
Pulse Modulation .....	4.102
Pulse Modulation Menu .....	4.102
Frequency Modulation - FM .....	4.104
Frequency Modulation Menu.....	4.105
Phase Modulation - PhiM .....	4.108
Phase Modulation Menu.....	4.109
<b>I/Q Modulation .....</b>	<b>4.113</b>
Introduction - I/Q Modulation .....	4.113
I/Q Modulator - I/Q MOD Function Block .....	4.114
I/Q Settings Menu.....	4.114
<b>Impairment of Digital I/Q Signal and Noise Generator - AWGN-IMP Block .....</b>	<b>4.123</b>
Introduction - Impairments and AWGN .....	4.123
Differential Output.....	4.124
Introduction - Impairments.....	4.127
Impairment Settings Menu .....	4.128
Introduction - Noise Generator - AWGN.....	4.135
AWGN Settings Menu .....	4.135
<b>Baseband Signal - Baseband.....</b>	<b>4.144</b>
Introduction - Baseband Signal .....	4.144
Signal Routing and Frequency Shifting .....	4.145
Data and Signal Sources in Baseband .....	4.150
Internal PRBS Data and Data Patterns .....	4.151
Internal Modulation Data from Lists.....	4.152
External Synchronous Modulation Data.....	4.153
External Asynchronous Modulation Data .....	4.153
Clock Signals.....	4.154

Synchronizing Data Signals and Clock Signals .....	4.155
Control Signals .....	4.159
Trigger Signals .....	4.160
Marker Output Signals.....	4.161
<b>Digital Modulation - Custom Digital Modulation .....</b>	<b>4.162</b>
Introduction - Custom Digital Modulation .....	4.162
Modulation Types - Custom Digital Mod .....	4.162
Coding - Custom Digital Mod .....	4.167
Baseband Filter - Custom Digital Mod .....	4.169
Conflicting Settings - Custom Digital Mod .....	4.172
Custom Digital Mod Menu .....	4.172
Custom Digital Modulation Main Menu .....	4.173
List Management - Digital Modulation menu.....	4.185
Data List Editor - Digital Modulation .....	4.188
Control and Marker List Editor - Digital Modulation.....	4.190
Power Ramp Control - Digital Modulation Menu .....	4.195
Trigger/Marker/Clock - Custom Digital Modulation Menu .....	4.198
<b>Arbitrary Waveform Generator ARB.....</b>	<b>4.206</b>
Introduction - ARB .....	4.206
ARB Menu .....	4.209
ARB MOD Main Menu .....	4.210
Trigger/Marker/Clock - ARB MOD Menu.....	4.219
Sine Test Signals - ARB MOD Menu .....	4.227
Create Multi-Segment Waveforms - ARB Menu .....	4.228
Typical Applications for Multisegment Waveforms - ARB Menu....	4.233
Create Multi-Carrier Waveforms - ARB Menu .....	4.234
ARB Multi-Carrier Submenu.....	4.235
Typical Applications for Multi-carrier Waveforms - ARB Menu .....	4.244
<b>Multicarrier Continuous Wave .....</b>	<b>4.244</b>
Introduction - Multicarrier CW.....	4.244
Multicarrier CW Main Menu.....	4.246
Trigger/Marker/Clock Menu - Multicarrier CW.....	4.253
<b>Digital Standard GSM/EDGE .....</b>	<b>4.260</b>
Introduction - Digital Standard GSM/EDGE .....	4.260
GSM/EDGE menu .....	4.261
Digital Standard GSM/EDGE Main Menu .....	4.262
Mode Unframed - GSM/EDGE .....	4.268
Mode Framed (single) - GSM/EDGE .....	4.270
Mode Framed (double) - GSM/EDGE .....	4.272
Save Recall Frame/Slots - GSM/EDGE .....	4.274
Modulation - GSM/EDGE .....	4.277
Power Ramping - GSM/EDGE .....	4.279
Trigger/Marker/Clock - GSM/EDGE .....	4.282
Burst Editor - GSM/EDGE .....	4.292
Slot Marker Definition - GSM/EDGE .....	4.304
<b>Digital Standard 3GPP FDD.....</b>	<b>4.309</b>
Introduction - Digital Standard 3GPP FDD.....	4.309
Modulation System 3GPP FDD.....	4.312
Scrambling Code Generator - 3GPP FDD .....	4.312

Scrambling Unit - 3GPP FDD .....	4.315
Channelization Code Generator - 3GPP FDD .....	4.316
Data Source - 3GPP FDD .....	4.316
Slot and Frame Builder - 3GPP FDD .....	4.316
Timing Offset - 3GPP FDD .....	4.317
Demultiplexer - 3GPP FDD .....	4.318
Power Control - 3GPP FDD .....	4.318
Summation and Filtering - 3GPP FDD .....	4.319
Multicode - 3GPP FDD .....	4.319
3GPP FDD Menu.....	4.320
General Settings for 3GPP FDD Signals .....	4.321
Configure Base Station or UE - 3GPP FDD .....	4.326
Filtering, Clipping, ARB Settings - 3GPP FDD.....	4.332
Trigger/Marker/Clock - 3GPP FDD.....	4.337
Test Setups - Models - 3GPP FDD .....	4.346
Predefined Settings - Downlink - 3GPP FDD.....	4.349
Additional User Equipment - Uplink - 3GPP FDD .....	4.351
Base Station Configuration - 3GPP FDD .....	4.353
Compressed Mode - BS - 3GPP FDD.....	4.357
Code Domain Graph – BS – 3GPP FDD .....	4.362
Channel Graph – Base Station – 3GPP FDD .....	4.365
Channel Table - BS - 3GPP FDD.....	4.365
HSDPA Settings - BS - 3GPP FDD.....	4.373
Enhanced Settings for P-CCPCH - BS1 - 3GPP FDD .....	4.379
Channel Coding - Enhanced P-CCPCH BS1 - 3GPP FDD .....	4.380
Enhanced settings for DPCHs - BS1 - 3GPP FDD .....	4.381
Channel Coding - Enhanced DPCHs BS1 - 3GPP FDD .....	4.383
Dynamic Power Control - Enhanced DPCHs BS1 - 3GPP FDD....	4.392
DPCCH Settings - BS Channel Table 3GPP FDD .....	4.397
Config F-DPCH - BS Channel Table 3GPP FDD.....	4.402
Config AICH or AP-AICH - BS Channel Table 3GPP FDD.....	4.406
Config E-RGCH – E-HICH - BS Channel Table 3GPP FDD.....	4.407
Multi Channel Assistant - BS - 3GPP FDD .....	4.409
User Equipment Configuration (UE) - 3GPP FDD .....	4.413
Common Settings - UE - 3GPP FDD .....	4.416
Code Domain Graph - UE - 3GPP FDD.....	4.419
Compressed Mode Configuration Graph - User Equipment - 3GPP FDD .....	4.422
PRACH Settings - UE - 3GPP FDD .....	4.424
Channel Coding State - PRACH UE - 3GPP FDD .....	4.431
PCPCH Settings - UE - 3GPP FDD .....	4.432
Channel Coding - PCPCH UE1 - 3GPP FDD .....	4.441
DPCCH Settings - UE - 3GPP FDD .....	4.442
E-DPCCH Settings - UE - 3GPP FDD.....	4.448
HS-DPCCH Settings - UE - 3GPP FDD.....	4.450
DPDCH Settings - UE - 3GPP FDD .....	4.454
Channel Table- DPDCH UE - 3GPP FDD.....	4.458
E-DPDCH Settings - UE - 3GPP FDD.....	4.461
HSUPA FRC Settings - UE - 3GPP FDD .....	4.466
Global Enhanced Channel Settings - UE1 - 3GPP FDD.....	4.470
Channel Coding - DPDCH Enhanced UE 1 - 3GPP FDD.....	4.471
Transport Channel - Enhanced DPDCH UE1 - 3GPP FDD .....	4.474
Error Insertion - Enhanced DPDCH UE1 - 3GPP FDD .....	4.477
Dynamic Power Control - DPDCH Enhanced User Equipment - 3GPP FDD .....	4.478

<b>Tests on Base Stations in Conformance with the 3G Standard 3GPP-FDD</b> .....	<b>4.481</b>
Introduction - Test Case Wizard .....	4.481
General Considerations - Test Case Wizard - 3GPP FDD .....	4.483
General Settings - Test Case Wizard - 3GPP FDD .....	4.485
Basestation Configuration - Test Case Wizard - 3GPP FDD .....	4.488
Apply - Test Case Wizard - 3GPP FDD .....	4.489
Transmitter Tests - 3GPP FDD .....	4.490
Basic Configuration - Transmitter Tests - 3GPP FDD.....	4.490
Test Case 6.4.2 - Power Control Steps.....	4.490
Test Case 6.6 - Transmit Intermodulation .....	4.496
Overview - Receiver Tests - 3GPP FDD .....	4.500
Basic Configuration - Receiver Tests - 3GPP FDD.....	4.500
Test Setups - Receiver Tests - 3GPP FDD.....	4.500
Carrying Out a Receiver Test Measurement.....	4.503
General Wanted Signal Parameters - Receiver Tests - 3GPP FDD.....	4.504
Receiver Characteristics - Receiver Tests - 3GPP FDD.....	4.505
Test Case 7.2 - Reference Sensitivity Level .....	4.505
Test Case 7.3 - Dynamic Range .....	4.506
Test Case 7.4 - Adjacent Channel Selectivity .....	4.508
Test Case 7.5 - Blocking Characteristics .....	4.510
Test Case 7.6 - Intermodulation Characteristics .....	4.516
Test Case 7.8 - Verification of Internal BER .....	4.519
Performance Requirements - Receiver Tests - 3GPP FDD.....	4.521
Test Case 8.2.1 - Demodulation of DCH in Static Propagation Conditions .....	4.521
Test Case 8.6 - Verification of Internal BLER .....	4.524
Test Case 8.8.1 - RACH Preamble Detection in Static Propagation Conditions .....	4.526
Test Case 8.8.3 - RACH Demodulation of Message Part in Static Propagation Conditions .....	4.528
Test Case 8.9.1 - CPCH Access Preamble and Collision Detection Preamble Detection in Static Propagation Conditions .....	4.532
Test Case 8.9.3 - Demodulation of CPCH Message in Static Propagation Conditions .....	4.532
<b>Digital Standard CDMA2000</b> .....	<b>4.533</b>
Introduction - Digital Standard CDMA2000 .....	4.533
Modulation System CDMA2000 .....	4.535
Modulation System CDMA2000 in the Downlink (Forward).....	4.535
Modulation System CDMA2000 in the Uplink (Reverse) .....	4.536
Data Source - Uplink and Downlink.....	4.536
Channel Coding - Uplink and Downlink.....	4.536
Long-Code Scrambling Generator - Downlink .....	4.537
Power Control Puncturing - Downlink .....	4.538
Variable-Length Walsh Spreading - Downlink.....	4.538
PN Short-Code Scrambling - Downlink .....	4.538
Spreading - Uplink .....	4.538
Scrambling - Uplink .....	4.539
Baseband Filtering - Uplink and Downlink .....	4.541
I/Q Modulator - Uplink and Downlink.....	4.541
Constellation of I/Q Signals - Downlink .....	4.542
Power Control - CDMA2000 - Downlink and Uplink.....	4.543
CDMA2000 Menu .....	4.544
General Settings for CDMA2000 Signals.....	4.545

Configure Base Station or Mobile Station - CDMA2000 .....	4.551
Filtering, Clipping, ARB Settings - CDMA2000 .....	4.555
Trigger-Marker-Clock - CDMA2000.....	4.560
Predefined Settings - Downlink - CDMA2000 .....	4.568
Additional Mobile Station - Uplink - CDMA2000.....	4.571
Base Station Configuration - CDMA2000.....	4.573
Channel Table - BS - CDMA2000 .....	4.580
More Parameters - BS Channel Table CDMA2000 .....	4.587
Power Control - More Parameters BS - CDMA2000.....	4.589
Channel Coding - More Parameters BS - CDMA2000.....	4.592
Error Insertion - More Params BS - CDMA2000 .....	4.595
More Parameters for F-PDCH - BS - CDMA2000.....	4.596
Subpacket Table- More Para2ms F-PDCHs BS - CDMA2000 .....	4.599
Subpacket Graph - More Params F-PDCHs BS - CDMA2000 .....	4.602
Mobile Station Configuration (MS)- CDMA2000 .....	4.603
Common Settings - MS - CDMA2000 .....	4.603
Power Control - MS - CDMA2000 .....	4.606
Channel Table - MS - CDMA2000.....	4.608
<b>Digital Standard IEEE 802.11a WLAN .....</b>	<b>4.612</b>
Introduction - Digital Standard WLAN .....	4.612
Physical Layer OFDM .....	4.613
Physical Layer CCK-PBCC .....	4.616
Data Spreading and Modulation CCK-PBCC .....	4.617
WLAN Menu .....	4.621
General Settings for WLAN Signals .....	4.622
PPDU/Sequence Configuration - WLAN .....	4.629
MAC Header and FCS Configuration - WLAN .....	4.636
PPDU Graph - WLAN.....	4.639
Filter, Clipping - WLAN.....	4.640
Trigger/Marker/Clock - WLAN .....	4.642
<b>Digital Standard IEEE 802.16 WiMAX.....</b>	<b>4.651</b>
Introduction - Digital Standard WiMAX.....	4.651
WiMAX Menu.....	4.653
General Settings for WiMAX Signals .....	4.654
Frame Configuration OFDM - WiMAX.....	4.664
Burst Table OFDM- WiMAX .....	4.668
Frame Graph OFDM - WiMAX .....	4.672
Show Active Carriers OFDM - WiMAX.....	4.673
FCH Configuration Downlink OFDM- WiMAX.....	4.673
Generate UL-MAP Uplink OFDM- WiMAX.....	4.676
UL-MAP Downlink OFDM- WiMAX .....	4.677
More Parameters Uplink OFDM- WiMAX.....	4.678
MAC Header Configuration OFDM - WiMAX .....	4.679
Frame Configuration OFDMA - WiMAX .....	4.681
Time Plan - WiMAX .....	4.685
Zone Table OFDMA- WiMAX.....	4.686
Zone Configuration OFDMA - WiMAX.....	4.688
Burst Table OFDMA - WiMAX.....	4.690
FCH Configuration Downlink OFDMA - WiMAX.....	4.694
DL-MAP Configuration Downlink OFDMA - WiMAX .....	4.695
Data Configuration OFDMA - WiMAX .....	4.698
UL-MAP Configuration Downlink OFDMA - WiMAX .....	4.699
Generate UL-MAP Uplink OFDMA- WiMAX .....	4.701
Ranging Uplink OFDMA - WiMAX.....	4.703
MAC Header Configuration OFDMA - WiMAX.....	4.704



Filter / Clipping Settings - WiMAX .....	4.706
Trigger/Marker/Clock - WiMAX.....	4.709
<b>Digital Standard GPS.....</b>	<b>4.718</b>
Introduction - Digital Standard GPS .....	4.718
GPS Menu .....	4.719
General Settings for GPS Simulation.....	4.720
Satellite Configuration - GPS .....	4.729
Trigger/Marker/Clock - GPS .....	4.732
<b>Digital Standard TD-SCDMA .....</b>	<b>4.742</b>
Introduction - TD-SCDMA (3GPP TDD LCR).....	4.742
Modulation System TD-SCDMA.....	4.744
TD-SCDMA Signal Structure (Frames and Time Slots).....	4.744
DwPTS and UpPTS.....	4.744
Structure of Traffic Burst .....	4.745
TD-SCDMA Menu.....	4.747
General Settings for TD-SCDMA Signals .....	4.748
Filtering, Clipping, ARB Settings - TD-SCDMA.....	4.756
Power Ramping- TD-SCDMA.....	4.760
Trigger-Marker-Clock - TD-SCDMA .....	4.761
Predefined Settings - TD-SCDMA.....	4.768
Cell Configuration - TD-SCDMA.....	4.770
Enhanced Channels Settings – TD-SCDMA.....	4.773
Enhanced Channel Settings – Details – TD-SCDMA .....	4.778
Slot Configuration – TD-SCDMA.....	4.782
Channel Table – TD-SCDMA.....	4.783
DPCCH Settings – TD-SCDMA.....	4.787
Slot Mode PRACH Settings – TD-SCDMA .....	4.791
Code Domain – TD-SCDMA .....	4.794
Channel Graph – TD-SCDMA.....	4.795

## Figures

Fig. 4-1	Input control signals for List Modes Fast Hop and Fast Hop Direct on the serial FHOP bus of the Digital I/O interface .....	4.68
Fig. 4-2	Definition of I/Q modulator in IS2000 and R&S Vector Signal Generator.....	4.120
Fig. 4-3	9-bit PRBS generator.....	4.151
Fig. 4-4	Output signal on the serial data interface and clock output signals on the AUX I/O interface .....	4.155
Fig. 4-5	Data and clock output signals on the parallel AUX I/O interface .....	4.156
Fig. 4-6	External serial data and the clock signals which are output (bit clock and symbol clock). The setup time ( $t_{\text{setup}}$ ) and hold time ( $t_{\text{hold}}$ ) can be found in the data sheet.....	4.156
Fig. 4-7	External parallel data, internal clock signal and the clock signal that is output on the AUX I/O interface The setup time ( $t_{\text{setup}}$ ) and hold time ( $t_{\text{hold}}$ ) can be found in the data sheet. ....	4.157
Fig. 4-8	External serial data and external symbol clock - 3 bits/symbol with high and low active <b>symbol clock</b> for marking the LSB. The data and the symbol clock must change state simultaneously. The setup time ( $t_{\text{setup}}$ ) and hold time ( $t_{\text{hold}}$ ) can be found in the data sheet. ....	4.157
Fig. 4-9	External parallel data with high and low active external symbol clock. The setup time ( $t_{\text{setup}}$ ) and hold time ( $t_{\text{hold}}$ ) can be found in the data sheet. ....	4.158
Fig. 4-10	Signal behavior when power ramping is enabled. The <b>Burst Gate</b> signal defines the start of the rising and falling edges of the envelope, and the <b>Lev_Att</b> signal defines the start and end of level attenuation. The level attenuation value is defined in the <b>Power Ramp Control</b> menu. ....	4.160
Fig. 4-16	Components of the 3GPP FDD transmission system.....	4.332
Fig. 4-17	Structure of downlink scrambling code generator.....	4.333
Fig. 4-18	Structure of uplink short scrambling code generator .....	4.334
Fig. 4-19	Constellation diagram of a channel with 0 dB power.....	4.335
Fig. 4-20	Constellation diagram of a channel with -6 dB power.....	4.338
Fig. 4-21	Constellation diagram of a 3GPP W-CDMA signal with two DPCH channels.....	4.339
Fig. 4-22	Constellation diagram of the signal without clipping, shows the level mapping for vector mode .....	4.354
Fig. 4-23	Constellation diagram with clipping level 50 %, vector mode ( $ i+q $ ).....	4.354
Fig. 4-24	Constellation diagram of the signal with 4 DPCH without clipping, shows the level mapping in scalar mode.....	4.356
Fig. 4-25	Envelope of compressed mode signal with single-frame method .....	4.381
Fig. 4-26	Envelope of compressed mode signal with double-frame method .....	4.381
Fig. 4-27	Code tree of channelization codes.....	4.382
Fig. 4-28	Structure of a downlink DPCH in the time domain.....	4.388
Fig. 4-30	Generation of a channel coded P-CCPCH/BCH.....	4.400
Fig. 4-31	Channel coding of the 12.2 kbps reference measurement channel (downlink).....	4.403
Fig. 4-32	Dynamic Power Control - Down Link .....	4.413

Fig. 4-33	Dynamic change of channel power (continuous).....	4.421
Fig. 4-34	Dynamic change of channel power (continuous).....	4.331
Fig. 4-35	Envelope of compressed mode signal with single-frame method .....	4.349
Fig. 4-36	Envelope of compressed mode signal with double-frame method .....	4.349
Fig. 4-37	Structure of an uplink DPCH in the time domain .....	4.369
Fig. 4-38	Dynamic change of channel power (continuous).....	4.373
Fig. 4-39	Structure of an uplink HS-DPCCH in the time domain .....	4.376
Fig. 4-40	Timing offset between the uplink DPCCCH, the HS-PDSCH and the HS-DPCCH at the 'UE.....	4.376
Fig. 4-41	Channel coding of the 12.2 kbps reference measurement channels (uplink).....	4.397
Fig. 4-42	Components of the CDMA2000 transmission system in the downlink (forward).....	4.461
Fig. 4-43	Components of the CDMA2000 transmission system in the uplink (reverse) .....	4.462
Fig. 4-44	Long-code generator CDMA2000 .....	4.463
Fig. 4-45	Scrambling in the uplink RC 1 and RC2 .....	4.465
Fig. 4-46	Scrambling in the uplink RC 1 and RC2 .....	4.466
Fig. 4-47	Definition of IQ modulator in IS2000 and R&S Vector Signal Generator.....	4.467
Fig. 4-48	Constellation diagram of a BPSK channel with 0 dB power .....	4.468
Fig. 4-49	Constellation diagram of a QPSK channel with 0 dB power.....	4.469
Fig. 4-50	Constellation diagram of the signal without clipping, shows the level mapping .....	4.483
Fig. 4-51	Constellation diagram with clipping level 80 %, vector mode ( $ i+q $ ) The circle emphasizes the changed constellation points.....	4.483
Fig. 4-52	Generation scheme of Walsh code.....	4.502
Fig. 4-53	Walsh code tree .....	4.503
Fig. 4-54	Dynamic change of channel power (continuous).....	4.517
Fig. 4-55	Dynamic change of channel power (continuous).....	4.533
Fig. 4-56	Principle of 802.11b/g signal generation.....	4.543
Fig. 4-57	Principle of PBCC modulation.....	4.546
Fig. 4-63	Constellation diagram of the signal without clipping, shows the level mapping .....	4.684
Fig. 4-64	Constellation diagram with clipping level 380 %, vector mode ( $ i+jq $ ).....	4.684

## Tables

Table 4-1	Preset state - important generator settings.....	4.5
Table 4-1	Function of data bits of FHOP bus (fhop_data line, see following figure) and their function for controlling fast frequency hopping .....	4.68
Table 4-2	Combinations of signal routings for two-path instruments .....	4.149
Table 4-3	PRBS generators .....	4.152
Table 4-4	Modulation type and associated mapping .....	4.163
Table 4-5	Permissible coding combinations for modulation symbols and modulation type.....	4.167
Table 4-6	Phase shifts for $\pi/4$ DQPSK .....	4.167
Table 4-7	Coding algorithms .....	4.168
Table 4-8	Differential coding according to VDL.....	4.169
Table 4-9	Baseband filter .....	4.169
Table 4-10	Standards - Custom Digital Modulation .....	4.178
Table 4-11	Parameters of the modulation system 3GPP FDD .....	4.331
Table 4-12	Generator polynomials of the downlink scrambling code generators .....	4.332
Table 4-13	Generator polynomials of the uplink long scrambling code generator.....	4.333
Table 4-14	Generator polynomials of uplink short scrambling code generator .....	4.334
Table 4-15	Mapping of the quaternary output sequence into the binary IQ level .....	4.334
Table 4-16	Hierarchical structure of 3GPP FDD frames.....	4.336
Table 4-17	Defined settings for the OCNS signal in base station 1 in <b>Standard</b> mode .....	4.348
Table 4-18	Defined settings for the OCNS signal in base station 1 in <b>HSDPA</b> mode .....	4.348
Table 4-19	Changing the crest factor by clipping (vector mode $ i+q $ ) for signal configurations with different output crest factors. 100% clipping levels mean that clipping does not take place.....	4.354
Table 4-20	List of supported channel types and their sequence in the 3GPP FDD channel table...	4.387
Table 4-21	The table below shows a summary of the transport channel parameters of the 12.2 kbps reference measurement channel .....	4.403
Table 4-22	Structure of the DPDCH channel table in conjunction with the overall symbol rate .....	4.382
Table 4-23	Structure of the E-DPDCH channel table in conjunction with the overall symbol rate and no DPDCH activ .....	4.389
Table 4-24	Structure of the E-DPDCH channel table in conjunction with the overall symbol rate and one DPDCH activ .....	4.390
Table 4-25	Parameters of the modulation system CDMA2000.....	4.460
Table 4-26	List of supported channel types and their sequence in the CDMA2000 channel table ..	4.508
Table 4-27	List of supported channel types .....	4.534
Table 4-28	Parameters of 802.11a/g OFDM modulation .....	4.539
Table 4-29	Parameters of the modulation system IEEE 802.16 WiMAX.....	4.578
Table 4-31	Parameters of the modulation system TD-SCDMA .....	4.669

# Instrument Functions

## Overview of Instrument Functions

This chapter explains the functions of the vector signal generator and the options available in the setting menus. The associated IEC/IEEE-bus command is specified for each parameter (where applicable).

The description begins with the general instrument settings which do not directly affect signal generation. The majority of these settings can be accessed by means of front-panel softkey menus and not by means of function block menus. One exception is, for example, the signal graphics which are called up in the **Graphics** block.

The signal generation functions are then described, beginning with the RF section functions which affect the RF signal and the analog modulations and which are compiled in the **RF/A Mod** block of the block diagram.

This is followed by an explanation of all functions which are in the signal flow prior to being fed into the RF block and which do not affect the internal generation of a baseband signal - I/Q modulation, noise generation and impairment of the digital signal, fading and the input of external baseband signals. These functions are accessed by means of the function blocks **Baseband Input, Fading, I/Q Mod** and **AWGN/IMP**.

The remaining (and largest) part of the chapter describes the functions used for the internal generation of the signals in the baseband (these functions are provided in the **Baseband** block).

The general instrument settings include various functions, such as:

- Setting a defined basic setup using the **[PRESET]** key  
(section "[Default Instrument Settings - Preset Key](#)" on page 4.4")
- Switching from remote control to manual control using the **[LOCAL]** key  
(section "[Switching to Manual Control - Local Key](#)" on page 4.20")
- Configuring the generator and its interfaces in the **Setup** menu - e.g. setting the IEC/IEEE-bus address, starting an adjustment, querying instrument data  
(section "[General Configuration of Instrument - Setup Key](#)", page 4.5)
- Generating a hardcopy of the display using the **[HCOPY]** key  
(section "[Generating a Hardcopy of Display - Hcopy Key](#)", page 4.21)
- Calling up the online help using the **[HELP]** key  
(section "[Help System - Help Key](#)", page 4.22)
- Querying messages using the **[INFO]** key  
(section "[Messages - Info Key](#)", page 4.21)
- Loading and storing complete instrument settings in the **File** menu  
(section "[Storing and Loading Instrument Data - File Key](#)", page 4.24)
- Calling up the baseband signal graphics in the **Graphics** function block  
(section "[Graphical Display - Graphics](#)", page 4.30)

The RF signal is configured and the analog modulations activated in the **RF/A Mod** function block:

- CW mode  
(section "[Overview of RF Signal and Analog Modulation](#)", page 4.42)
- List mode  
(section "[List Mode - List](#)", page 4.67)
- Sweep mode  
(section "[Sweep Mode](#)", page 4.79)
- Analog modulations  
(section "[Analog Modulations](#)", page 4.96)

In the I/Q-Mod function block, I/Q modulation is possible with external analog signals and internally generated baseband signals.

Noise can be added to the baseband signal and the baseband signal can be impaired or faded before input into the I/Q modulator. It is therefore possible to output a baseband signal with impairments via the I/Q-OUT outputs (**Impairment/AWGN** function block). Impairment is also possible during I/Q modulation (**I/Q Mod** function block).

- I/Q modulator  
(section "[I/Q Modulator - I/Q MOD](#)", page 4.114)
- Impairing the signal prior to input into the I/Q modulator  
(section "[Introduction - Impairments and AWGN](#)", page 4.113)
- Adding noise  
(section "[Introduction - Impairments and AWGN](#)", page 4.113)

The baseband signal is available at the I/O outputs.

- Differential Outputs  
(section "[Differential Output](#)", page 4.124)

The R&S Vector Signal Generator offers various possibilities for generating digital modulation signals in compliance with the definitions of digital standards or with characteristics which can to a large extent be freely defined. The range of software options for this is being extended continuously. In addition, external baseband signals can be fed into the baseband path.

- Baseband signals - Introduction  
(section "[Baseband Signal - Baseband](#)", page 4.144)
- Digital modulation  
(section "[Digital Modulation - Custom Digital Modulation](#)", page 4.162)
- Arbitrary waveform generator ARB  
(section "Arbitrary Waveform Generator ARB page 4.206)
- Multicarrier CW signals  
(section "[Multicarrier Continuous Wave](#)", page 4.244)
- Digital standard GSM/EDGE  
(section "[Digital Standard GSM/EDGE](#)", page 4.262)
- Digital standard 3GPP FDD (WCDMA)  
(section "[Digital Standard 3GPP FDD](#)", page 4.329)
- Tests on Base Stations  
(section "[Tests on Base Stations in Conformance with the 3G Standard 3GPP-FDD](#)", page 4.498)

- Digital standard CDMA2000  
(section "[Introduction - Digital Standard CDMA2000](#)", page 4.616)
- Digital standard WLAN  
(section "[Digital Standard IEEE 802.11a WLAN](#)", page 4.628)
- Digital standard WiMAX  
(section "[Digital Standard IEEE 802.16 WiMAX](#)", page 4.667)
- Digital standard GPS  
(section "[Digital Standard GPS](#)", page 4.732)
- Digital Standard TD-SCDMA  
(section "[Digital Standard TD-SCDMA](#)", page 4.755)

# General Instrument Settings

## Overview of General Instrument Settings

The section "General Instrument Settings" describes the settings which do not directly affect signal generation.

Most of these settings can only be accessed by means of menus which are opened using keys. This does not apply to the graphical representation of output signals which is activated in the **Graphics** function block, or settings which can additionally be called up in the menus of the function blocks, e.g. input configuration which is possible in the **Setup** menu and in almost every menu of the **Baseband** function block.

The general instrument settings therefore affect various functions, such as storing instrument settings or setting the IEC/IEEE-bus address in the menu of the **SETUP** key (CTRL+E). The order in which the descriptions are given corresponds to the layout of the keys on the front panel of the Vector Signal Generator (from top left to bottom right).

## Default Instrument Settings - Preset Key

The **PRESET** key (CTRL+P) calls up a defined instrument setup. All parameters and switching states are preset (also those of inactive operating modes). The default instrument settings provide a reproducible initial basis for all other settings.

Remote-control command:

\*RST

---

**Note:**

*In remote control it is possible to preset the settings of the two instrument path separately (see chapter 6, Section 'Preset Commands').*

---

In addition, only those settings associated with the menu can be reset directly in the individual menus, e.g. all digital modulation settings in the **Custom Digital Mod** menu. These settings are identical to those which are called up using the **PRESET** key (CTRL+P).

When the instrument is switched on, it is not the preset state that is active, but rather the instrument state that was set before the instrument was switched on.

User-defined instrument states can be stored and called up in the **File** menu.



The following table gives an overview of the presets for the most important generator settings. The other presets can be found in the preset tables of the individual menus and the information accompanying the IEC/IEEE-bus commands.

Table 4-1 Preset state - important generator settings

RF frequency	1 GHz
RF level	RF output switched off
Reference frequency	Internal, adjustment off
Offsets	0
Modulations	Switched off
Uninterrupted level setting	Switch off; level attenuator mode: AUTO
Internal level control	Level ALC: AUTO
User correction	Level Ucor: OFF
LF output	Switched off
Sweep	Switched off
List mode	Switched off
IEC/IEEE-bus address	Not changed

## General Configuration of Instrument - Setup Key

The **[SETUP]** key (CTRL+E) opens the **System** menu used to set general instrument parameters and the **Environment** menu used to configure the instrument interfaces.

Most submenus of this key can be accessed only via the **[SETUP]** key (CTRL+E) or the menu tree (**[MENU]** key), with the following exceptions:

- The **Reference Oscillator** submenu can also be called up in the **RF / A Mod** block and is therefore described in the section on this block (see section "[RF Reference Frequency - Reference Oscillator](#)", page 4.47).
- The **Save/Recall** submenu can also be called up with the **[FILE]** key and is therefore described in the section on this key (see section "[Storing and Loading Instrument Data - File Key](#)", page 4.24).
- The **Global Trigger/Clock/ External Inputs** submenu (see section "[Global Trigger/Clock/External Input Settings - Setup-Environment](#)", page 4.13) is also available in all modulation menus of the **Baseband** function block where it can be called up with the **Global Trigger/Clock Settings** button in the trigger/marker and clock submenus.

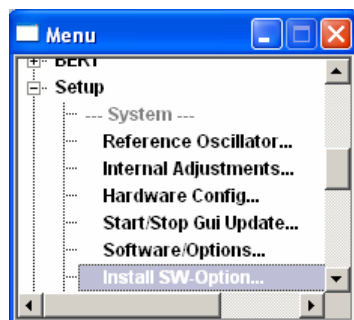

## Internal Adjustments - Setup-System

The R&S Vector Signal Generator is extremely accurate thanks to the integrated procedures for adjustments.

All internal adjustments for which no external measuring equipment is needed can be started in the **Internal Adjustments...** menu. The adjustments with external measuring equipment are described in the Service Manual (on CD ROM, supplied with the instrument).

Adjustment is recommended if the temperature range in which the instrument is operated changes, or prior to all applications which require maximum level and frequency accuracy.

During adjustment a bar indicates the status of progress. If an error occurs, adjustment is terminated and an error message is output in the info line.

### Caution:

*Make sure that the instrument is warm before performing adjustments. The warm-up time is 30 minutes.*

In the case of two-path instruments, adjustment can be performed separately for the two paths.

The **Internal Adjustments** menu is opened up using the **[SETUP]** (CTRL+E) or **[MENU]** key (CTRL+M) under **System**. The adjustments offered also depend on the installed options, e.g. FM Modulator.

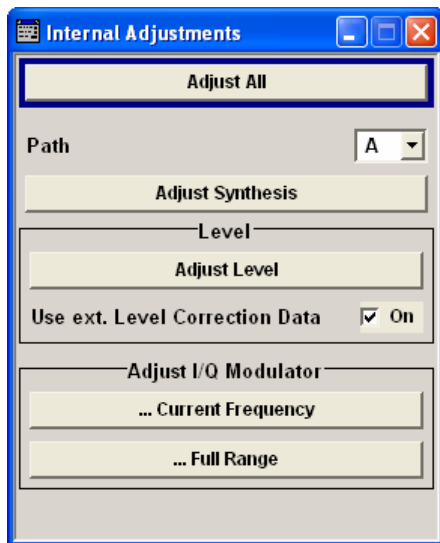

### Adjust All - Setup Internal Adjustments

Starts all internal adjustments for which no external measuring equipment is needed. The adjustments with external measuring equipment are described in the Service Manual (supplied).

With two-path instruments, adjustment is performed for both paths.

Remote-control command:

CAL:ALL?

<b>Path - Setup Internal Adjustments</b>	<p>Selects the path for which the following adjustments are to be performed.</p> <p>Remote-control command: n.a. (With remote control, the path is selected using the numerical suffix under CALibrate.)</p>
<b>Adjust Synthesis - Setup Internal Adjustments</b>	<p>Performs all adjustments which affect the frequency of the selected path.</p> <p>This includes adjustment of option FM/PhiM Modulator.</p> <p>This includes adjustment of option R&amp;S SMATE-B22, FM/PhiM Modulator and Low Phase Noise.</p> <p>Remote-control command: CAL1:FREQ:MEAS?</p>
<b>Adjust Level - Setup Internal Adjustments</b>	<p>Performs all adjustments which affect the level of the selected path.</p> <p>Remote-control command: CAL:LEV:MEAS?</p>
<b>Use Level Adjustment Data - Setup Internal Adjustments</b>	<p>Switch on or off use of external level correction data for the selected path (see service manual, chapter 2, "Adjustment"). This switch can be used in case of corrupt external level correction data.</p> <p>Remote-control command: CAL:LEV:STAT ON</p>
<b>Adjust I/Q Modulator Current Frequency - Setup Internal Adjustments</b>	<p>Starts the adjustment for the I/Q modulator for the currently set frequency, I/Q swap, and baseband gain. The I/Q modulator is adjusted with respect to carrier leakage, I/Q imbalance and quadrature.</p> <p>Adjustment for only the set frequency is considerably faster than adjustment across the entire frequency range. This is possible with ... <b>Full Range.</b></p> <p>Remote-control command: CAL1:IQM:LOC</p>

**Adjust I/Q Modulator Full Range- Setup Internal Adjustments** Starts the adjustment for the I/Q modulator for the entire frequency range. The I/Q modulator is adjusted with respect to carrier leakage, I/Q imbalance and quadrature.

Remote-control command:  
CAL1 : IQM : FULL?

**Adjust Baseband Input- Setup Internal Adjustments** Starts the adjustment for the analog I/Q input. The I/Q input is adjusted with respect to DC offset and gain.

Remote-control command:  
CAL : BBIN : MEAS

## Hardware Config... - Setup-System

In the **Hardware Config** menu, the installed assemblies together with their variants and revision states can be displayed for servicing purposes.

The **Hardware Config** menu is opened using the **SETUP** (CTRL+E) or **MENU** key (CTRL+M) key under **System**.

Section **Counter** in the upper part of the menu shows the **Operation Hours** and the number of power-on (**Power On Counter**).

Remote-control command:

DIAG : INFO : OTIM?

Response: "100023"

DIAG : INFO : POC?

Response: "123"

A table below lists the installed assemblies. It is divided into the sections **Common Assembly**, **RF Assembly** and **Baseband Assembly**.

<b>Path</b>	Shows the path to which the assembly belongs
<b>Assembly</b>	Assembly name
<b>Part Number</b>	Part Number of assembly
<b>Serial Number</b>	Serial Number of assembly
<b>Revision</b>	Revision state of assembly
<b>At slot</b>	Indicates whether the assembly is connected to the serial bus or PCI bus

Remote-control command:

DIAG : BGIN? "MBRD"

Response:

"MBRD 1141.3501.02 1.5.3 100023"

## Gui Update... - Setup/System

The **Start/Stop Gui Update** menu... provides the possibility to switch off update of the displayed parameters in order to increase speed for certain settings.

The indicated values are not updated and may therefore differ from the intern, used values.

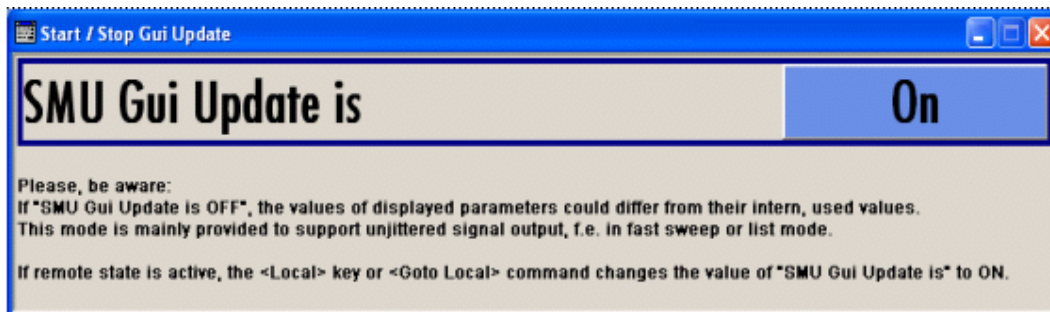

Remote-control command:

```
SYST:DISP:UPD OFF
```

## Software / Options... - Setup/System

The **Software / Options...** shows the firmware version of the instrument software as well as all installed hardware and software options.

---

### Note:

*Software options purchased at a later stage can be activated with a keycode. The activation code is supplied with the software option. How to install options is described in Chapter 4 of the Service Manual (supplied with the instrument).*

*The installation of hardware options purchased at a later stage is also described in Chapter 4 of the Service Manual (supplied with the instrument). Most hardware options need to be installed at an authorized Rohde&Schwarz service shop.*

---

The **Software / Options** menu is opened using the **SETUP** (CTRL+E) or **MENU** key under **System**.

Remote-control commands:

```
*OPT?
```

Response:

```
SMATE-B106/B116, SMATE-B203, SMATE-B10, SMATE-B10, SMATE-B13, SMATE-B13,
...."
```

```
*IDN?
```

Response:

```
"Rohde&Schwarz, SMATE200A, 1400.7005k02/123456, 1.00.0.0 (Release) "
```

The **Firmware** section of the menu shows the firmware version and the version of the software platform.

The tables in the sections **Hardware**, **Software** and **WinIQSIM** list the installed hardware and software options.

<b>Option</b>	Short name of option
<b>Designation</b>	Name of Option
<b>Licenses</b>	Number of licenses The license for the software options are "floating licenses". This means that in the case of two-path instruments just one license is required to use the option for either of the two paths. However, two licenses must be purchased to use an option on both paths simultaneously.
<b>Expiration Date</b>	Expiration date of option For regular options, Permanent is indicated in this column. Some options are available as trial versions. This column shows their expiration date. After this date, the option is no longer available on the instrument.

Section **Loaded Modules** is provided for service purposes. It lists all loaded software modules with their versions and offers a short description of each module.

## Install SW-Option... - Setup/System

Newly purchased software options are enabled in the **Install SW-Options** menu.... They are ready to operate after they are enabled by means of a key code supplied with the option.



Only if the R&S Vector Signal Generator is equipped with an older firmware version, a firmware update prior to enabling the software option may be required. The information on the valid firmware versions for the purchased software option is provided together with the option. The firmware update is described in the service manual instrument, chapter 4 (on CD ROM, supplied with the instrument).

## Test Point... - Setup-Test

The **Test Point...** menu provides access to the test points available in the instrument. When activated, the voltage of the selected test point is measured and displayed. A detailed description of the test points can be found in Chapter 3 of the Service Manual (supplied with the instrument).

The **Test Point...** menu is opened using the **[SETUP]** (CTRL+E) or **[MENU]** key under **System**.

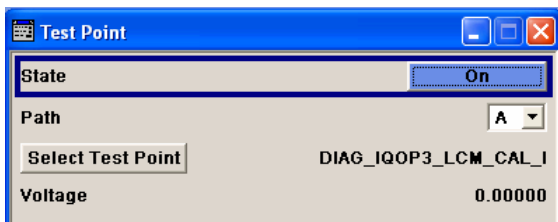

**State Test Point - Setup**

Activates the measurement of the voltage at the selected test point.

Remote-control command:

```
DIAG1:MEAS:POIN? 'DIAG_IQOP3_LCM_CAL_I'
```

Response: 2

**Path Test Point - Setup**

Selects the path along which the test point is measured. Selection is only possible with two-path instruments.

Remote-control command: n.a.

(The path is selected using the suffix under DIAGnostic)

**Select Test Point - Setup**

Calls the submenu for selecting the test point. The currently selected key is shown next to the key.

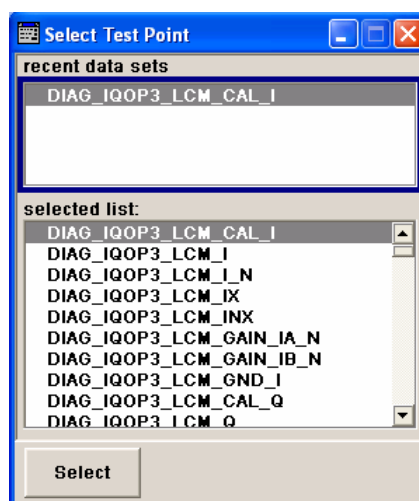

Remote-control commands:

```
DIAG1:POIN:CAT? (Command lists all test points)
```

```
DIAG1:POIN? 'DIAG_IQOP3_LCM_CAL_I'
```

(With remote control, voltage measurement starts as soon as the test point is selected)

**Voltage Test Point - Setup**

Displays the measured voltage measurement at the selected test point.

Remote-control command:

```
DIAG1:MEAS:POIN? 'DIAG_IQOP3_LCM_CAL_I'
```

Response: 2

## Check Front Panel - Setup-Test

The **Check Front Panel** menu.. is used to check whether the front panel keys are functioning correctly. The menu displays all the front panel keys arranged in the same way as on the front panel. The respective function is executed by pressing the associated key.





## Global Trigger/Clock/External Input Settings - Setup-Environment

The **Global Trigger/Clock/External Inputs** menu can be opened using the **SETUP** or **MENU** key under the **Environment** menu as well as in all clock and trigger menus of the **Baseband** function block.

This menu is used to determine the physical characteristics of the input connectors for trigger, clock and control signals of the baseband and RF section. The user inputs/outputs (BNC connector and pins of the AUX I/O connector) are assigned in a submenu.

A common trigger threshold and input impedance is effective for all trigger and control signal inputs (Path A and Path B). The settings influence the digital modulations, the generation of waveforms or multicarrier signals, and all digital standards. Irrespective of this, a common threshold and input impedance is effective for the serial and parallel data input (Path A only). These data sources are available for digital modulation (**Custom Digital Modulation**).

The instrument trigger setting influences all sweeps and is effective in the List mode (Instrument Trigger, Path A and Path B).

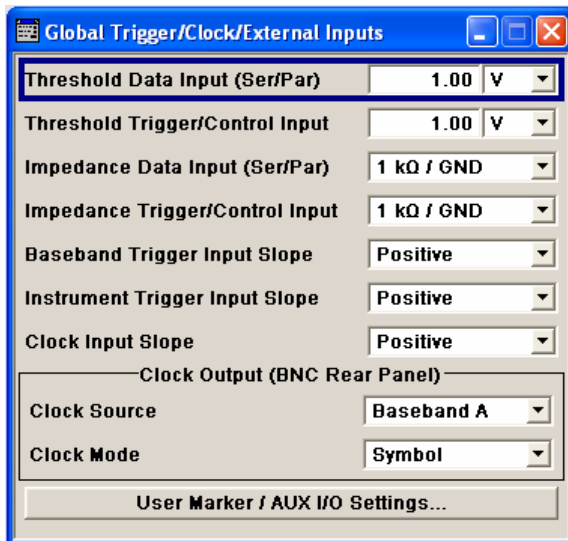

### Threshold Data Input - Global Settings

Sets the high/low threshold in volts for the serial and parallel data input.

The serial data is input at the DATA connector on the front of the instrument. The parallel data is input via the AUX I/O interface at the rear of the instrument (DATA pins).

Remote-control command:

```
SOUR:INP:DATA:THR 1.0
```

<b>Threshold Trigger/Control Input - Global Settings</b>	<p>Sets the high/low threshold in volts for the trigger and control signal inputs of the baseband section.</p> <p>The setting affects the TRIGGER 1 and 2 inputs (BNC connectors at the front and rear of the instrument) and the CW, BURST and LEV_ATT inputs (AUX I/O interface at the rear of the instrument).</p> <p>Remote-control command: SOUR:INP:TRIG:LEV 1.0</p>
<b>Impedance Data Input - Global Settings</b>	<p>Selects the input impedance for the serial and parallel data inputs. 50 Ohm/GND should be selected for high clock rates.</p> <p>The serial data is input at the DATA connector on the front of the instrument. The parallel data is input via the AUX I/O interface at the rear of the instrument (DATA pins).</p> <p>Remote-control command: SOUR:INP:DATA:IMP G50</p>
<b>Impedance Trigger/Control Input - Global Settings</b>	<p>Selects the input impedance for the external trigger and control signal inputs. 50 Ohm/GND should be selected for high clock rates.</p> <p>The setting affects the TRIGGER 1 and 2 inputs (BNC connectors at the front and rear of the instrument) and the CW, BURST and LEV_ATT inputs (AUX I/O interface at the rear of the instrument).</p> <p>Remote-control command: SOUR:INP:TRIG:IMP G1K</p>
<b>Baseband Trigger Input Slope - Global Settings</b>	<p>Selects the polarity of the active slope of an externally applied trigger signal at the BNC connector TRIGGER 1/2.</p> <p>Remote-control command: SOUR:INP:TRIG:BBAN:SLOP POS</p>
<b>Instrument Trigger Input Slope - Global Settings</b>	<p>Sets the polarity of the active slope of an applied instrument trigger.</p> <p>This setting affects the INST TRIG input (BNC connector at the rear of the instrument, instrument trigger for Path A) and the INST TRIG B input of the AUX I/O interface at the rear of the instrument, instrument trigger for Path B).</p> <p>Remote-control command: SOUR:INP:TRIG:SLOP POS</p>

**Clock Input Slope - Global Settings**

Sets the polarity of the active slope of an externally applied bit clock pulse or symbol clock pulse.

This setting affects the CLOCK input (BNC connector at the front of the instrument). An external clock signal can only be supplied for Path A.

Remote-control command:

CLOC:INP:SLOP POS

The polarity of the clock output at the rear panel is set and the path selected in the **Clock Output (BNC Rear Panel)** section.

**Clock Output Source - Global Settings**

Indicates the path for which the clock signal at the CLOCK OUT connector is to be output (always path A).

This setting is only possible for two-path instruments.

Remote-control command:

CLOC:OUTP:SOUR?

Response: A

**Clock Output Mode - Global Settings**

Sets the output of bit or symbol clock pulses at the CLOCK OUT connector at the rear panel.

Remote-control command:

CLOC:OUTP:MODE SYMB

**User Marker - AUX IO Settings - Global Settings**

Calls the menu for configuring the AUX I/O and user interfaces (see the following section "[User Marker - AUX IO - Setup-Environment-Global...Settings](#)").

The pin assignment of the AUX I/O interface is shown in the **User Marker - AUX I/O Configuration** menu; the assignment of the USER pins 2...4 and USER 1 BNC connector can be changed.

With two-path instruments, the current assignment to the respective path is given in addition to the pin assignment.

## User Marker - AUX IO - Setup-Environment-Global...Settings

The R&S Vector Signal Generator provides four USER interfaces which can be freely assigned a selection of signals and which can be configured as both inputs and outputs.

The following signals can be applied at the connector:

- **Marker 4** (output Path A or B). A broad selection of suitable marker signals is offered in the marker menus of the **Baseband** function. In addition, they can be freely configured in the Control List Editor (**Custom Dig Mod**) and Slot Marker Editor (**GSM/EDGE**). The selected markers are activated when switching on the **Baseband** function. When using markers defined in a control list (Marker = CList) the related control list must be loaded in addition (**Custom Dig Mod**).
- **CW Mode Out** (output Path A or B). This signal marks the CW mode in which digital modulation (**Custom Dig Mod**) is deactivated and the RF signal is output in unmodulated form. The CW signal is defined in a control list and activated by loading the control list and setting the **Modulation ⇄ CW Switching** State to **On** in the **More** sub menu. With standards where it is possible to change between various modulation modes, the signal indicates the active modulation mode (standard GSM: signal high (1) = modulation mode GMSK and signal low (0) = modulation mode 8PSK EDGE). In this cases, the signal is generated automatically when the standard is switched on.
- **No Signal (Blank) Marker** (output Path A or B). This signal marks the blank time in the List mode. The signal is generated automatically when the list mode is switched on.
- **HOP** (output Path A or B). This signal marks the hop trigger for frequency hopping in the List mode for **Custom Digital Mod**. The hop signal is defined in a control list and activated by loading the control list in the **Custom Dig Mod** menu.
- **Trigger** (output Path A or B). This signal marks the trigger event caused by the selected trigger signal (internally or externally) of path A or B. The trigger is defined in the respective trigger submenu of the **Baseband** block menus.

Additional signals for Path B are available in the case of two-path instruments. The corresponding signals for Path A are applied at the pins of the AUX I/O interface and at the BNC connector CLOCK.

- **Clock Out** (output Path B; bit or symbol clock pulse). This signal corresponds to the clock signal for digital modulations. The signal is generated automatically when the standard is switched on.
- **LEV ATT** (input/output Path B). With active envelope curve control, this signal determines whether or not the signal level is attenuated. With external envelope curve control, the interface is input, otherwise output. The envelope curve control is activated in the **Power Ramp Control** submenu in the **Custom Digital Modulation** menu. The internal LEV ATT control signal is defined in a control list which must be loaded in the main menu.
- **BURST** (input/output Path B). This signal corresponds to the control signal for envelope curve control. With external envelope curve control, the interface is input, otherwise output. The envelope curve control is activated in the **Power Ramp Control** submenu in the **Custom Digital Modulation** menu. The internal BURST control signal is defined in a control list which must be loaded in the main menu.



The **User Marker - AUX I/O** menu can be opened using the **SETUP** key (CTRL+E) under **Environment - Global Trigger/Clock/External Inputs** or in the **Global Trigger/Clock/External Inputs** submenu of the **Trigger** menu, e.g. from the **GSM/EDGE** menu in the **Baseband A/B** function block.

The signals are assigned to the USER interfaces in the Mapping Configuration section. The pin assignment of the AUX I/O connector is also displayed. An adapter between the AUX I/O interface and coaxial BNC connections is available as an accessory (Accessories for R&S SMATE-Z5, see data sheet).

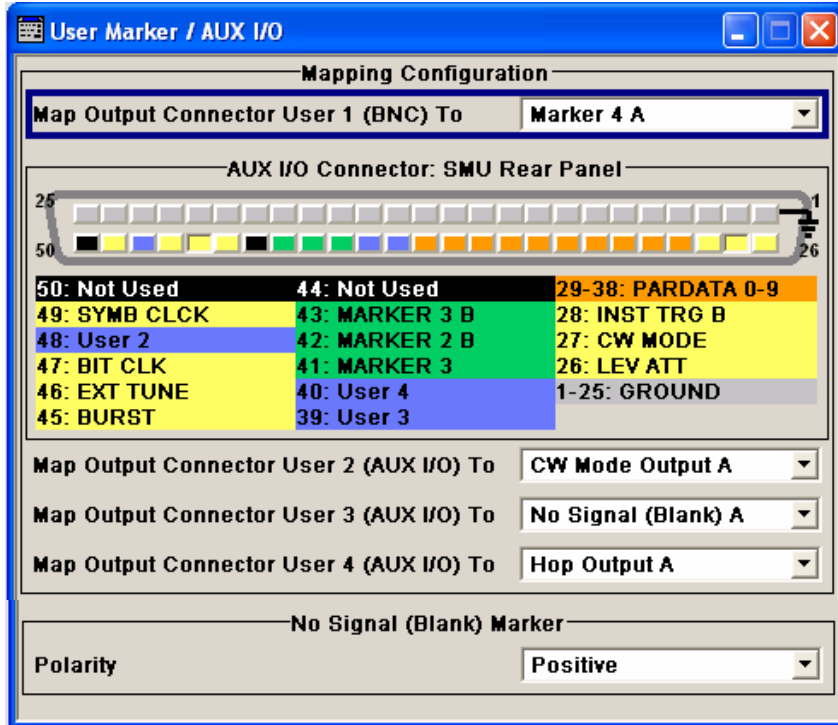
The polarity of the blank marker is selected in the **No Signal (Blank) Marker** section.



**AUX I/O Connector Mapping - AUX IO Configuration**

An illustration of the AUX I/O interface is shown. The pins are color-coded. The inputs are indicated by a "depressed" pin , outputs by a non-depressed pin .

The assignment is shown in tabular form underneath the interface. The colors indicate the signal type. A distinction is made between control signals (yellow), marker signals (green), data (orange), freely selectable signals at the user pins (blue), ground (gray), and unused pins (black).

If no path letter is specified, the pin is assigned to the signals of Path A. Pins with signals from Path B are indicated by a "B" to the right of the signal name. This does not apply to the EXT TUNE input via which the signal for external impairment of the reference frequency is supplied; this impairment signal applies to both paths.

Connection	Description
1... 25 - ⊥	Ground
26 - LEV ATT	Signal input/output for controlling the level attenuation (Path A only). With external envelope curve control ( <b>Custom Digital Modulation</b> only), the pin is the input for the control signal LEV_ATT. With internal envelope curve control, the control signal LEV_ATT is output for Path A. With two-path instruments, the signal for Path B can be applied to one of the user interfaces.

Connection	Description
27 - CW MODE	Signal input for controlling the switchover between the modulated and unmodulated RF signal with activated external modulation/CW switching in the <b>Custom Digital Modulation</b> menu (CW control signal, Path A and/or Path B).  Signal output for the CW control signal with internal source selected. This signal marks the CW mode in which digital modulation is deactivated and the RF signal is output in unmodulated form. In the case of digital standards with selectable modulation mode, the signal indicates the active modulation mode (GSM: (G)MSK = high, 8PSK EDGE = low)
28 - INST TRIG B	Input for external triggering of the analog modulations, sweeps and List mode. HOP input for controlling the frequency hopping mode with external source in List mode (Path B). The instrument trigger input for Path A is input via the BNC connector INST TRIG.
29 - PARDATA0 ...	Parallel data input/output 0...D with 10-bit word width for digital modulation. If the data source "external parallel" is selected, these pins are the data inputs. If a different data source is selected, the data is output here ( <b>Custom Digital Modulation</b> , Path A).
38 - PARDATA9	
39 - USER 3	USER input/output which can be configured for various purposes (see above).
40 - USER 4	USER input/output which can be configured for various purposes (see above).
41 - MARKER 3	Output for the freely programmable marker signal 3 of Path A. The output is permanently assigned.
42 - MARKER 2 B	Output for the freely programmable marker signal 2 of Path B.
43 - MARKER 3 B	Output for the freely programmable marker signal 3 of Path B. The output is permanently assigned.
44 - not used	Pin is not used.
45 - BURST	Signal input/output for controlling the burst ramp, Path A. With external envelope curve control ( <b>Custom Digital Modulation</b> only), the pin is the input for the control signal BURST_RAMP. With internal envelope curve control, the control signal BURST_RAMP is output for Path A. With two-path instruments, the signal for Path B can be applied to one of the user interfaces.
46 - EXT TUNE	Tuning input for the internal reference frequency.
47 - BITCLK	Output Bit clock for internal mode (Path A only). With two-path instruments, the signal for Path B can be applied to one of the user interfaces.
48 - USER 2	USER input/output which can be configured for various purposes (see above).
49 - SYMBCLK	Symbol clock output for internal mode (Path A only). With two-path instruments, the signal for Path B can be applied to one of the user interfaces.
50 - not used	Pin is not used.

**User Connector Signal - AUX IO Configuration**

Selects the signal for USER interface 1 (BNC), 2, 3 or 4 (AUX I/O). The signals which are available for selection are given above.

Remote-control command:  
OUTP:USER2:SOUR AMAR

The polarity of the No Signal (Blank) Marker is set in the **No Signal (Blank) Marker** section.

**Polarity - No Signal Marker - AUX IO Configuration** Selects the polarity of the No Signal Marker. If **Positive** is selected, the signal is high (2.5 V) when the marker is active; if **Negative** is selected, the signal is low (0 V).

Remote-control command:

OUTP:BLAN:POL POS

## Remote GPIB - Setup-Remote

The **Remote GPIB...** menu provides access to the GPIB and Ethernet settings. The **Remote GPIB...** menu is opened using the **SETUP** or **MENU** key under **Remote**.

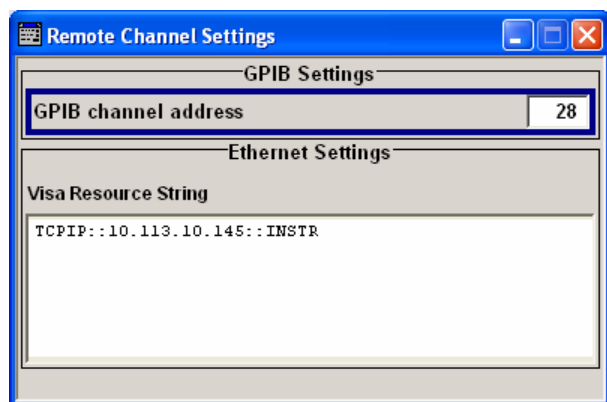

**GPIB channel address** Sets the IEC/IEEE-bus address of the instrument.

Remote-control command:

SYST:COMM:GPIB:ADDR 28

**Visa Resource String** Indicates the visa resource string. This string is used for remote control of the instrument.

Remote-control command:

SYST:COMM:NET:RES?

Response: TCPIP:192.1.2.3:INSTR

## Protection - Setup-Protection

The **Protection** menu provides access to the unlocking of protected service functions (authorized personnel of R&S Service Departments only). To unlock the lock-out, the correct password has to be entered. After the instrument has been switched on, the lock-out 2 to 5 is automatically activated.

Protection Level 1 can be activated to lock-out internal adjustment. The password is 123456.

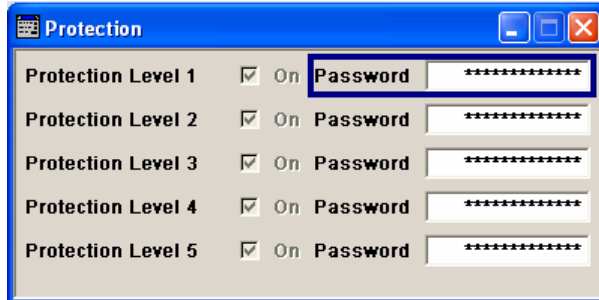

Remote-control command:

```
SYST:PROT1:STAT ON
SYST:PROT1:STAT OFF, 123456
```

## Save Recall - Setup-Setting

The **Save/Recall** submenu can also be called up with the **FILE** key and is therefore described in the section on this key (see section "[Storing and Loading Instrument Data - File Key](#)", page 4.24).

## Help - Setup-Help

The **Help** submenu offers comprehensive online help for the R&S Vector Signal Generator. A desired topic can be selected via the table of contents (select **Manual**) or the index (select **Index**).

For context-sensitive information about a marked parameter, press the **HELP** key. For a description of the **Help** menu, refer to the section covering to the **HELP** key (see section "[Help System - Help Key](#)", on page 4.22)

## Switching to Manual Control - Local Key

In remote control mode a status message appears in the display header. The rest of the display remains unchanged and shows the current instrument status, i.e. the status which exists under the remote control settings. The instrument can be operated (e.g. menus can be opened). However, it is not possible to enter or change values.



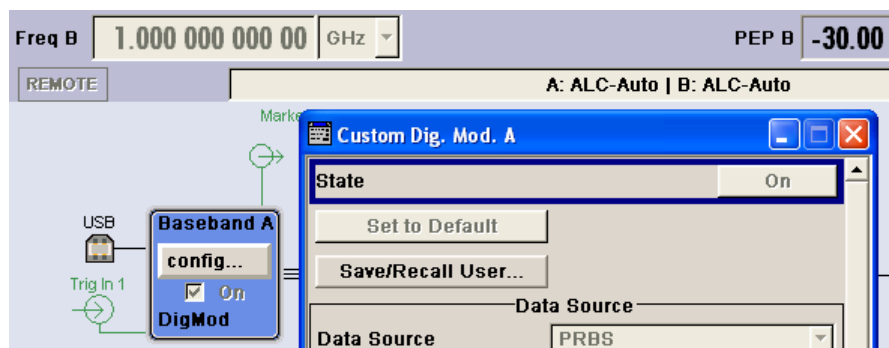

The status message additionally indicates whether the **LOCAL** key (CTRL+Q) is disabled or enabled (see also section ["Switch-Over to Remote Control"](#)).

If the **REMOTE** status message is shown, the **LOCAL** key switches the instrument from remote control to manual control. The current command must be fully processed before the mode is switched, otherwise the instrument switches immediately back to remote control.

If the **REM-LLO** status message is displayed, the instrument can be switched from remote control to manual control by means of remote control only (e.g. with the Visual Basic command `CALL IBLOC (generator%)`); the **LOCAL** key is disabled. The key is disabled by remote control with the command LLO.

When switching from remote to manual control, the display update suppression function, if active (**SETUP**- **GUI Update is Off**), is automatically deactivated (**SETUP**- **GUI Update is On**).

## Generating a Hardcopy of Display - Hcopy Key

The **HCOPY** key is without function for the Vector Signal Generator.

## Messages - Info Key

The **INFO** key (CTRL+I) opens a window containing a detailed description of every message displayed in the info bar, see chapter 3, section ["Info and Status Bar"](#) and chapter 9, section ["Error Messages"](#).

## Help System - Help Key

The **[HELP]** key (F1) opens a browser window containing a context-sensitive description of the highlighted parameter.

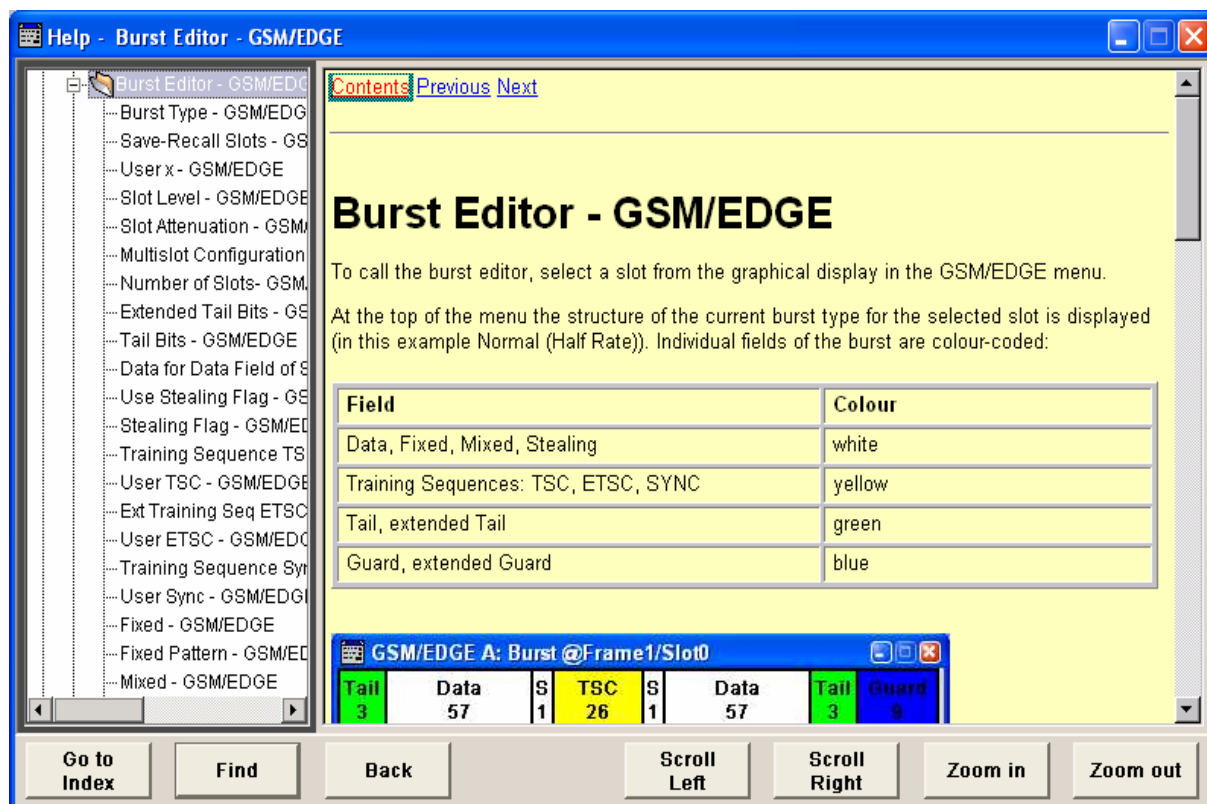

The context-sensitive page which is opened with the **[HELP]** key is part of a comprehensive help system. It is possible to move from this context-sensitive page to any page of the help system. The following navigation aids are available:

- **Internal links in the text**  
They open pages which are directly linked to the described function. In this way it is possible, for example, to call up the description of the IEC/IEEE-bus command for any particular function.
- **Previous/Next links**  
The Previous/Next links allow scroll through the help pages. The sequence of the described functions corresponds to their position in the menus.
- **Back softkey**  
The Back softkey calls up the page last viewed.
- **Contents in the navigation panel**  
The contents list is used to open the individual help pages. It has a hierarchical structure. The highlighted line indicates where the currently displayed page is within the contents list.
- **Index in the navigation panel**  
The index is used to call up all pages which contain the selected entry. The index has an alphabetical structure and also contains all IEC/IEEE-bus commands.

**- Text search softkey**

The text search allows you to look for freely selectable terms in all help pages. A list of the pages containing the entered term is displayed as the search result. The search can be limited to words in the page title to increase the number of hits.

The softkeys are used to determine the entry focus for front panel operation, to select the content of the navigation window and to change the font size. To determine the entry focus for front panel operation the Cursors UP/Down are used. The links are highlighted in blue, and can be selected and called up using the rotary knob.

**Index / Tree - Help**

Switches the navigation window display between the contents tree and index entries. The input focus must be in the left-hand navigation window.

Remote-control command: -

**Contents tree:**

The contents tree is the contents list of the help system. The cursor always highlights the entry which is currently being displayed in the right-hand help window. The associated page can be opened by selecting an entry.

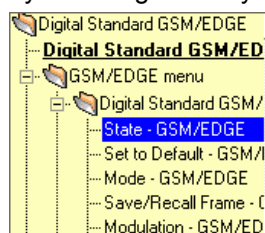

**Index:**

The index contains an alphabetical list of all terms which refer to functions of the instrument. For example, it contains all parameter names and all IEC/IEEE-bus commands. The associated help page can be opened by selecting an entry.

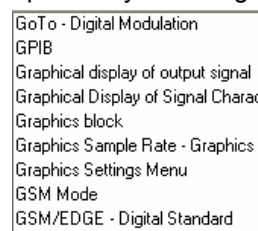

**Find - Help**

Opens the search panel. The content of the titles only or the complete help text can be searched for the entered term.

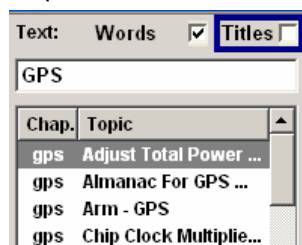

Remote-control command: -

**Scroll Left / Scroll Right - Help**

Shifts the indicated area of the navigation window.

Remote-control command: -

**Zoom in / Zoom out - Help**

Increases and reduces the font size of the help text.

Remote-control command: -

## Storing and Loading Instrument Data - File Key

The R&S Vector Signal Generator allows complete instrument settings to be stored in files on the hard disk. Defined and complex instrument settings can then be reproduced at any time by loading this data. If required, these settings can be loaded to various signal generators.

The **FILE** key (CTRL+S) open the menu used to store and load instrument settings in a file. The data can be stored on the hard disk in a data directory. Additionally there are three intermediate memories in which the current instrument setting can be stored and then called up again by pressing a key. This makes it possible to switch quickly between defined instrument settings.

All settings which differ from the preset plus the configuration data for the operating elements (e.g. window positions) are stored. When loaded, these referenced settings are implemented and all non-referenced parameters are set to the associated preset value. As a result the files remain relatively small since they only contain the relevant information. Furthermore, this also allows instrument settings to be transferred easily between different signal generators since once again only the settings which differ from the preset values have to be adjusted.

If a list, e.g. a frequency/level list, is used for the LIST mode or a list of frame or channel configurations is used for a digital standard, a reference to this list also stored. The list is also loaded when the associated instrument setting is loaded. If the list has been deleted in the meantime (or it is not available on a different instrument), an error message appears if an attempt is made to access this list after the instrument setting has been loaded. The associated setting or operating mode, e.g. the List mode, is only started after the user has selected an existing list. If the list has been overwritten in the meantime, the new entries will be used.

---

**Note:**

*Lists are stored and loaded in the appropriate menus. For example, the GSM frame definitions are created and stored in the GSM menu.*

---

When loading an instrument setting, it is possible to select whether the current frequency and level setting is to be retained or whether the stored settings are to be activated. It is possible to delete stored instrument settings. A file can be copied by loading it with "Recall" and then storing it under a new name.

Settings can be transferred easily between instruments with different equipment options and/or firmware versions because only the settings which differ from the preset values are affected. When settings are loaded, only those which are possible on the instrument are implemented. Error messages indicate the settings which cannot be implemented.

The stored file is transferred from one instrument to another using the memory stick or by means of a network drive.

General file management functions such as copying and moving data are available in the **File Manager** submenu.

## File Menu

The settings available in the File menu depend on the operation selected under **Select Operation**.



<b>Select Operation - File</b>	Selects the file function.
<b>Save...</b>	Calls the menu for storing the current instrument setting.
<b>Recall...</b>	Calls the menu for calling up a stored instrument setting.

## Storing Instrument Settings - File

If **Save** is selected under **Select Operation**, the File menu provides options for storing the current instrument setting in a file.

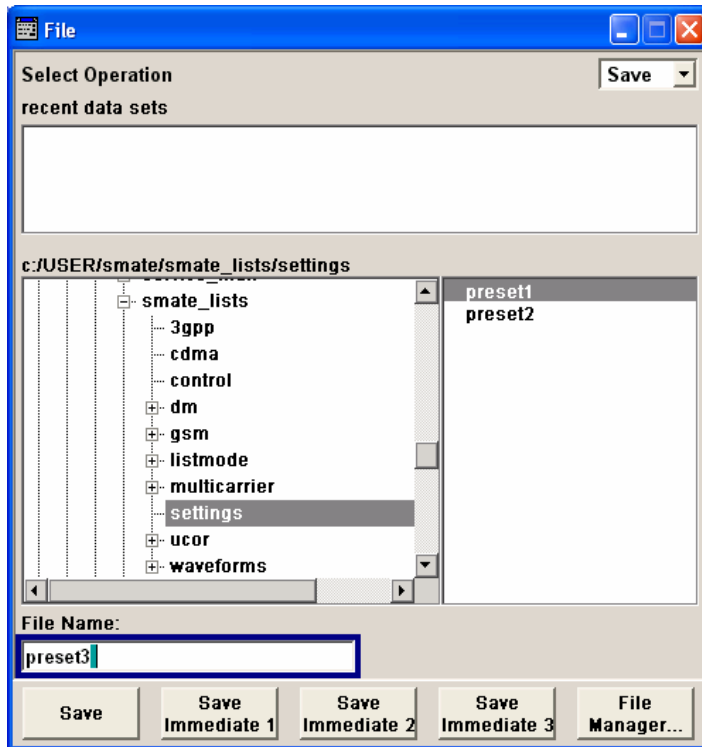

<b>Recent data sets - File</b>	Displays the files last used. The entire path is shown in plain text. Remote-control command: n.a.
--------------------------------	---

<b>Directory - File</b>	<p>Selects the directory in which the file is to be stored. The window opposite lists all settings files in this directory. A new directory can be created in the File Manager (<b>File Manager</b> button).</p> <p>Remote-control command: MMEM:CDIR "D:\user" (The path can also be entered when the file is stored.)</p>
<b>File List - File</b>	<p>Displays the files which are in the selected directory. If a file is highlighted, it is overwritten when the file is stored.</p> <p>Remote-control command: MMEM:CAT?</p>
<b>File Name - File</b>	<p>Enter the file name of the file without file extension. This file is then created.</p> <p>Remote-control command: n.a. (The file name is entered when the file is stored.)</p>
<b>Save - File</b>	<p>Stores the current instrument settings under the specified path.</p> <p>Remote-control command: MMEM:STOR:STAT 0, 'test'</p>
<b>Save Immediate x- File</b>	<p>Stores the current instrument setting in one of the three intermediate memories. These instrument settings are retained until a different instrument setting is stored in the intermediate memory. When the instrument is switched off, the contents of the intermediate memories are retained.</p> <p>Remote-control command: *SAV 1</p>
<b>File Management- File</b>	<p>Calls the <b>File Management</b> menu. Directories can be created and files managed in this menu (see the section "<a href="#">File Management - File</a>", page 4.28").</p> <p>Remote-control command: n.a.</p>

## Loading Instrument Settings - File

If **Recall** is selected under **Select Operation**, the **File** menu provides options for loading complete instrument settings. Here it is possible to select whether the current or stored RF frequency and RF level settings are to be used.

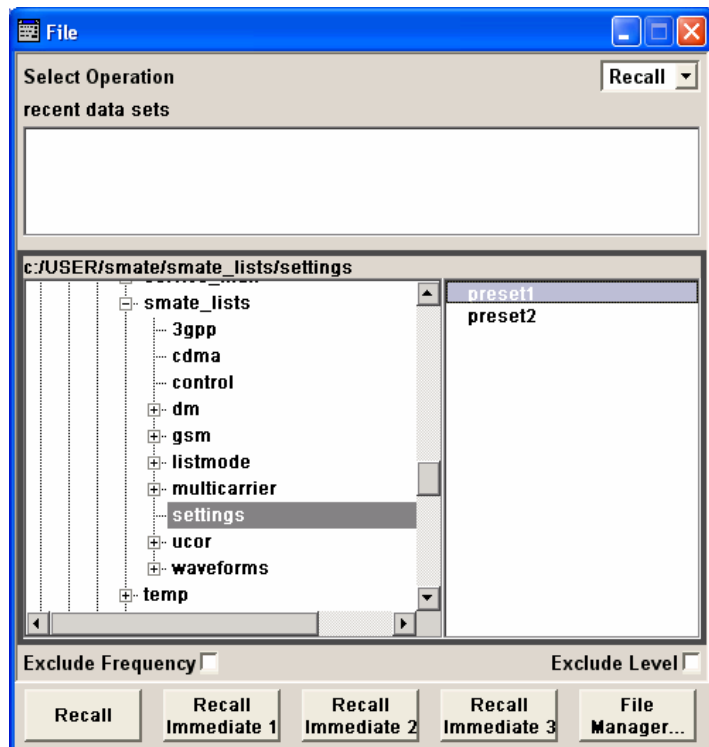

### Recent data sets - File

Displays the files last used. The entire path is shown.

If the desired file is in the list, it can be selected in this window.

Remote-control command: n.a.

### Directory - File

Enter the directory in which the file with the instrument setting to be loaded is located.

The **Selected file** window lists all the files in this directory.

Remote-control command:

MMEM:CDIR "D:\user"

### File List - File

Selects the file with the desired instrument configuration.:

Remote-control command:

MMEM:CAT?

### Exclude Frequency - File

The current frequency is retained when a stored instrument setting is loaded.

Remote-control command:

SOUR1:FREQ:RCL EXCL

<b>Exclude Level - File</b>	<p>The current level is retained when a stored instrument setting is loaded.</p> <p>Remote-control command: SOUR1:POW:RCL EXCL</p>
<b>Recall - File</b>	<p>Load the selected configuration.</p> <p>If an instrument setting in which a sweep was activated is stored, the sweep is started when the recall command is called.</p> <p>If an instrument setting which accesses lists is stored, this list is also loaded.</p> <p>If the list has been deleted in the meantime, an error message appears when the instrument setting is loaded. If the list has been overwritten in the meantime, the new entries will be used.</p> <p>Remote-control command: MMEM:LOAD:STAT 0, 'test'</p>
<b>Recall Intermediate x- File</b>	<p>Loads the selected configuration from one of the three intermediate memories.</p> <p>If an instrument setting in which a sweep was activated is stored, the sweep is started when the recall command is called.</p> <p>If an instrument setting which accesses lists is stored, this list is also loaded.</p> <p>If the list has been deleted in the meantime, an error message appears when the instrument setting is loaded. If the list has been overwritten in the meantime, the new entries will be used.</p> <p>A message appears if no instrument configuration is stored in this memory.</p> <p>Remote-control command: *RCL 1</p>

## File Management - File

The **File Management** menu provides all the functions required for file management. Directories can be created, and files copied, deleted and moved between the directories on the drives (hard disk, memory stick and network drives).

<b>File Type - File Management</b>	<p>Selects the file types to be indicated. If a file type with a specific file extension (e.g. List Mode List (*.lsw)) is selected only files with this extension are indicated in the selected directory.</p> <p>Remote-control command: n.a.</p>
------------------------------------	--



<b>Directory - File Management</b>	<p>Selects the directory in which the file to be deleted or copied is located. The window to the right lists all files in this directory. The file to be deleted or copied can be highlighted. The path is indicated above the directory window.</p> <p>Remote-control command: M MEM:CDIR "D:\user"</p>
<b>File Name - File Management</b>	<p>Selects the file.</p> <p>Remote-control command: n.a.</p>
<b>Cut - File Management</b>	<p>Cuts the selected file. It can be pasted into a different directory using the <b>Paste</b> button.</p> <p>Remote-control command: M MEM:DEL 'E:\test.savercl'</p>
<b>Copy - File Management</b>	<p>Copies the selected file. It can be pasted into a different or the same directory using the <b>Paste</b> button. When pasting the file into the same directory file name "Copy of &lt;filename&gt;" is given automatically. When pasting the file into a different directory, the original filename is kept.</p> <p>Remote-control command: M MEM:COPY "D:\user\set1.wv", "D:\user\set2.wv"</p>
<b>Paste - File Management</b>	<p>Pastes the file that has been copied or cut before.</p> <p>Remote-control command: n.a.</p>
<b>Rename - File Management</b>	<p>Renames the selected file or directory. The new name can be entered in the <b>New Filename</b> window.</p> <p>Remote-control command: M MEM:MOVE "test02.dm_iqd", "set2.dm_iqd"</p>
<b>Delete - File Management</b>	<p>Deletes the selected file. Before the file is deleted, a message appears prompting the user to confirm deletion of the file.</p> <p>Remote-control command: M MEM:DEL 'E:\test.savercl'</p>
<b>Create New Directory - File Management</b>	<p>Creates a new directory. The name of the new directory can be entered in the <b>New Directory</b> window.</p> <p>The directory is created as a subdirectory in the selected level.</p> <p>Remote-control command: M MEM:MDIR 'D:\user\test'</p>

**Note:**

*When the subdirectory is entered, it is possible to enter an absolute path name (e.g. "D:\USER\MEAS") or the path relative to the current directory (e.g. ". . \MEAS").*

# Graphical Display - Graphics

## Graphical Display of Signal Characteristics

The R&S Vector Signal Generator can be used to graphically display the generated baseband signal. A selection of different signal displays assists the user in assessing and checking the increasingly complex modulation signals.



The Graphics function block is available for instruments with the option R&S SMATE-B13 (Baseband Main Module) and one of the options R&S SMATE-B10/B11 (UniCod + ARB), or R&S SMATE-B62 (Noise Generator).

It is the baseband signal actually generated that is recorded and displayed, and not a signal calculated on the basis of the set parameters.

This graphical display allows the user to quickly view and check the current signal characteristics and also gives an overview of the changes in the signal over time. The signal quality can be permanently monitored. The results of parameter changes on the signal, such as a change in modulation mode, or the effects of certain configurations, e.g. the activation of several base stations in the case of (W)CDMA signals, can be analyzed directly in the display. Freezing the signal and then zooming permit a detailed evaluation of any signal segment. The definition and display of one or more reference curves makes it possible to compare various signals (i.e. by comparing the CCDF (Complementary Cumulative Distribution Function) with different channelization codes, or the spectra if different filter parameters are selected).

The displayed signal segment can be influenced by selecting the trigger that defines the time for recording to start. With automatic triggering, the signal is tapped at the point in the signal path that is best for the respective display. The displayed signal segment is selected internally depending on the signal such that the signal characteristics of interest (e.g. the useful signal) are displayed. This selection is appropriate for a representative display of the complete signal.

In addition, a user-definable trigger is available with which the displayed signal segment can be limited.

The time resolution can be set either automatically or manually, whereby for manual setting the bandwidth for which the trace is to be displayed is selected. The transient recorders used for signal recording have a variable recording depth which is specified under the respective display.

In addition to the large graphics window, the display can also be shown in a small window ("smart graphics"). This window is fitted into the block diagram as a block, and can be used for basic checking purposes (e.g. whether the signal is still being generated).

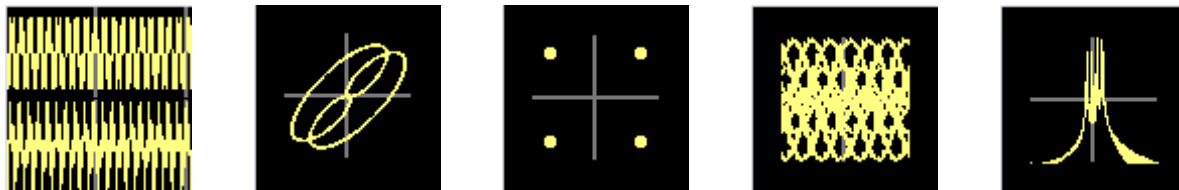

In the case of two-path instruments, the baseband signals of both paths can be displayed simultaneously.

## Graphics Settings Menu

The **Graphics Settings** menu for selecting the graphical display of the output signal is opened either in the **Graphics** function block or in the menu with the same name which is opened using the **[MENU]** key.

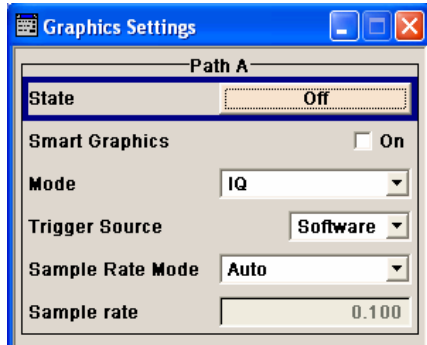

The signal display can be selected and activated in the menu.

With two-path instruments, the settings for the two paths can be entered separately. The signals can be displayed simultaneously in two separate windows.

### Status - Graphics Settings

Activates the selected graphical display.

After activation, the diagram selected with **Mode** is displayed in the block diagram.

At the bottom of each graphics window there are several buttons for freezing and zooming the display and for activating a reference curve (see the following section "[Softkey Bar of Graphics Window](#)", page 4.33).

Remote-control command: n.a.

### Smart Graphics - Graphics Settings

Activates the "smart graphics".

The graphic is displayed in a small window which is roughly the size of a block. These windows are displayed permanently in the block diagram until they are deactivated, and allow basic checking of the signal. They do not contain any buttons.

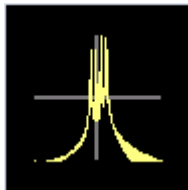

Remote-control command: n.a.

<b>Mode - Graphics Settings</b>	<p>Selects the graphical signal display. The display is not shown until it has been activated with <b>Status On</b>.</p> <p>The individual signal displays are described in the following sections under "<a href="#">Signal Displays - Graphics</a>", from page 4.36 onwards.</p> <p>Remote-control command: n.a.</p>
<b>Trigger Source - Graphics Settings</b>	<p>Defines the trigger for the starting time of the graphic recording.</p> <p>Remote-control command: n.a.</p>
	<p><b>Software</b> Recording of signals is started automatically in specified intervals.</p> <p>This asynchronous method is appropriate when a representative display of the complete signal is desired, as recording starts in a random time reference to the signal.</p>
	<p><b>Marker 1</b> The starting point for recording signals is determined by marker 1 in the menu of the active standard.</p> <p>This synchronous method is appropriate when specific signal segments are to be shown in greater detail. With periodic signals, a static image is obtained by selecting a period length of marker 1 that is equal to the signal period.</p> <p>The displayed signal segment can be shifted as needed by entering a marker delay in the Trigger/Marker menu of the active standard.</p>
<b>Scrambling Code - Graphics Settings</b>	<p>(only if Code Domain (3GPP FDD DL) is selected) Sets the scrambling code if the <b>Code Domain</b> display is selected. Since it is possible to select a different scrambling code in the menu for each of the 4 base stations and it is also possible to display an external signal, the scrambling code for which the display is to be generated must be explicitly specified here.</p> <p>Remote-control command: n.a.</p>
<b>Sample Rate Mode - Graphics Settings</b>	<p>Sets how the time resolution of the signal is determined. Maximum resolution corresponds to a display covering the entire signal bandwidth. The higher the resolution is, the shorter the length of the displayed signal segment will be for the specified recording depth.</p>
	<p><b>Auto</b> The resolution is set to an optimum value on the basis of the signal and display type.</p> <p>Remote-control command: n.a.</p>
	<p><b>Full Bandwidth</b> The resolution is set such that the display covers the entire signal bandwidth.</p> <p>Remote-control command: n.a.</p>

	<b>User</b>	Under <b>Graphics Sample Rate</b> , the user can determine the resolution by setting the signal bandwidth for which the display is to be generated. Remote-control command: n.a.
<b>Graphics Sample Rate - Graphics Settings</b>	With <b>Auto</b> and <b>Full Bandwidth</b> : Displays the signal bandwidth for which the display is to be generated. With <b>User</b> : Selects the signal bandwidth for which the display is to be generated. The setting range moves between the minimum and maximum bandwidth which is possible for the selected display. The selection is made graphically by moving the pointer. Remote-control command: n.a.	

## Softkey Bar of Graphics Window

At the bottom of each graphics window there are buttons for freezing and zooming the display and for defining and activating a reference curve.

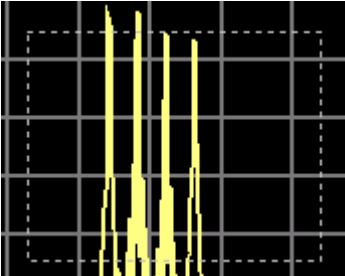

<b>Run</b>	Freezes the current display. Clicking the button again reactivates the normal, permanently updated display. Freezing the display allows it to be analyzed more easily. Zooming the display at the same time permits detailed evaluation of any signal segment. Remote-control command: n.a.
<b>Zoom In</b> (only possible with mouse)	The mouse can be used to freely select any section to be zoomed. This section is selected by pressing the left-hand mouse key and dragging a rectangular marquee. In this way a display can be zoomed in several steps. The zoom is cancelled by clicking the <b>Zoom Out</b> button.
	
	Remote-control command: n.a.
<b>Zoom out</b>	Cancels the zoom. Remote-control command: n.a.

**Time**  
(only I/Q mode)

Switches to seconds for time representation on the X axis of the I/Q diagram.

Remote-control command: n.a.

**Show ref**

Displays the reference curve(s). All defined reference curves are displayed simultaneously (see the description of the **Copy to ref** button).

The reference curves are displayed together with the current signal. They allow visual comparison of two or more signals with different settings, e.g. with different filters.

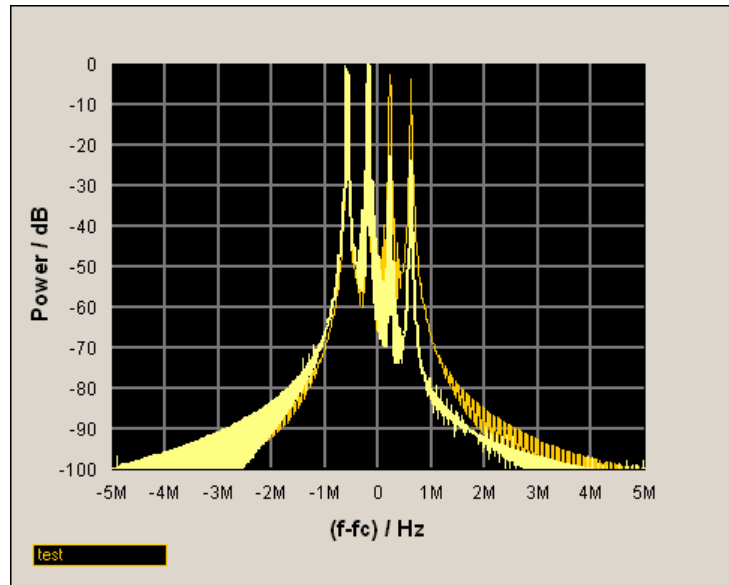

Clicking the button again hides the reference curves.

The reference curves must be defined beforehand using the **Copy to Ref** button.

Remote-control command: n.a.

**Copy to ref**

Defines the current curve as the reference curve.

A window opens in which the curve can be given a comment and a color.

First of all the desired color is highlighted in the top window. If this color has already been assigned to a reference curve, this curve is overwritten. The command is entered in the bottom **Comment** section. This comment then appears next to the highlighted color.

Up to 5 reference curves can be defined and displayed simultaneously in different colors together with the current signal.

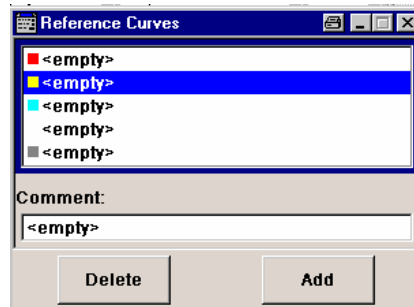

Each reference curve is available until it is deleted.

Remote-control command: n.a.

**Display area**

The comments entered for the defined reference curve are shown in the display area next to the assigned color. A maximum of five colors (and reference curves) are available. If no reference curve is assigned to a particular color, the comment <empty> is displayed.

Remote-control command: n.a.

**Comment**

Enters a comment for the current curve which is to be defined as the reference curve. This comment then appears next to the highlighted color in the display area.

Remote-control command: n.a.

**Delete**

Deletes the curve highlighted in the display area.

Curves which are no longer required can be deleted to reduce the number of reference curves displayed simultaneously.

Remote-control command: n.a.

**Assign**

Defines the current curve as the reference curve.

The new reference curve is shown together with the entered comment next to the selected color in the display area.

Remote-control command: n.a.

## Signal Displays - Graphics

All signal displays which are used for analyzing a baseband signal can be selected. A number of signal displays are only available if the corresponding signal is generated, e.g. Code Domain only available for (W)CDMA signals.

### I/Q Diagram - Graphics

The I/Q diagram displays the inphase component ( $i(t)$ ) and quadrature component ( $q(t)$ ) of the I/Q signal over time.

The diagram is displayed in a window with two separate coordinate systems. The coordinate systems have identical X and Y axes. The time (in number of symbols, chips or samples depending on the signal) is plotted on the X axes, and the amplitude scaled to the peak envelope power (PEP) is plotted on the Y axes (minimum scaled amplitude = -1; maximum scaled amplitude = +1). The recording depth is 1kSamples.

This signal is picked off at the output of the baseband main module (**Impairment** function block). Impairment of the signal as defined by the user and the addition of noise is contained in the displayed signal. Also, an added internal signal (from the second path) is included.

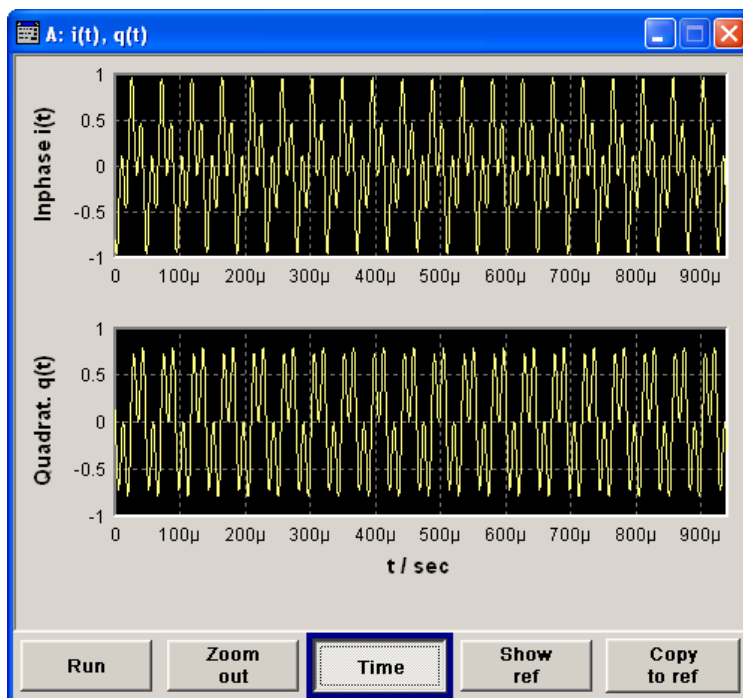



## Vector Diagram - Graphics

The Q component is displayed over the I component in the vector diagram. Each point is determined by a vector. The amplitudes of the signal components scaled to the peak envelope power (PEP) are plotted on the X and Y axis (minimum scaled amplitude = -1; maximum scaled amplitude = +1).

This display shows the curves between the various states of modulation mapping. The recording depth is 1kSamples.

This signal is picked off at the output of the baseband main module (**Impairment** function block). Impairment of the signal as defined by the user and the addition of noise is contained in the displayed signal.

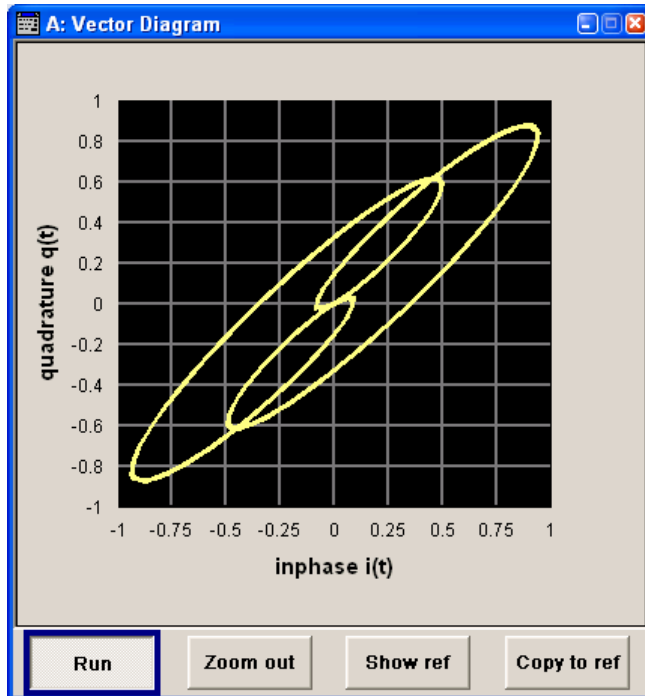

## Constellation Diagram - Graphics

In the constellation diagram, the Q component is also displayed over the I component. However, only the values at the constellation points (signal value at the ideal scanning instant of the symbol) are displayed, i.e. for each symbol only 1 value in the form of a circle is shown for the I and Q component.

The amplitudes of the signal components scaled to the peak envelope power (PEP) are plotted on the X and Y axis (minimum scaled amplitude = -1; maximum scaled amplitude = +1). The recording depth is 2kSamples.

This signal is picked off at the output of the unocoder (**Baseband** function block) upstream of baseband filtering. Impairment of the signal as defined by the user and the addition of noise is not effective in this signal because signal impairment and noise addition occur further down the signal path.

This display shows the various states of modulation mapping which occur in the signal. The example shows the constellation diagram of a QPSK modulation signal.

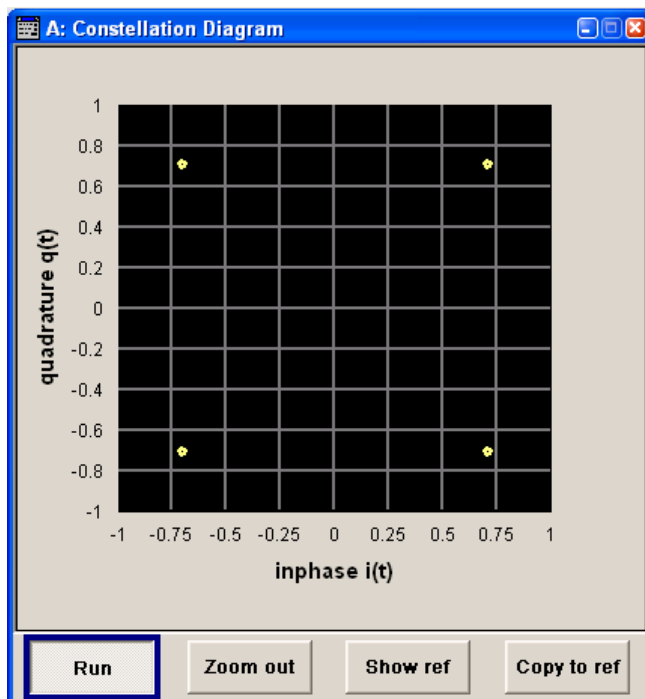

## Eye Diagram - Graphics

The eye diagram displays synchronized and superimposed sections of either the inphase or quadrature components of the signal.

The display width (eye length) is set at 2 symbols; several hundred curve segments are superimposed. The time (in the range  $\pm 1$  symbol) is plotted on the X axis, and the amplitude scaled to the peak envelope power (PEP) is plotted on the Y axis (minimum scaled amplitude = -1; maximum scaled amplitude = +1). The beginning of recording is synchronous to the symbol and chip clock pulse. The recording depth is 2kSamples.

This signal is picked off at the output of the uncoder (**Baseband** function block) downstream of baseband filtering. Impairment of the signal as defined by the user and the addition of noise is not effective in this signal because signal impairment and noise addition occur further down the signal path.

The exactness of the superimpositions and therefore the size of the eye gaps depend on the used filter.

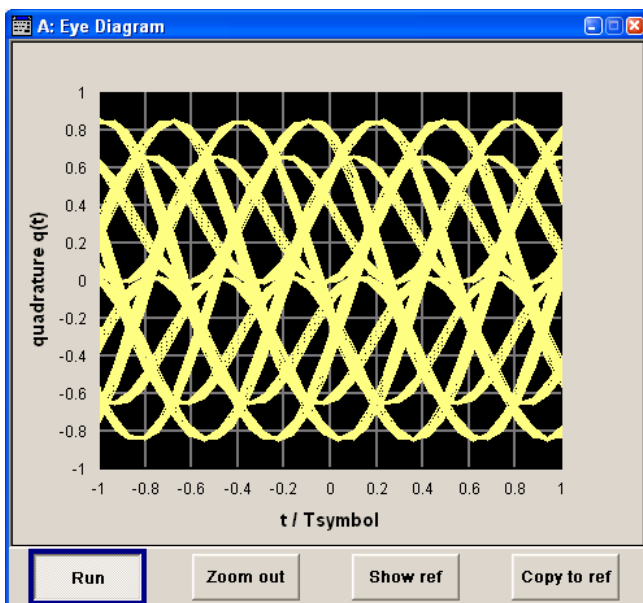

## CCDF Display - Graphics

The **Complementary Cumulative Distribution Function** shows the probability with which the output signal will exceed the average power.

The level over the average power is plotted from 0 to 20 dB on the X axis; the average power (RMS) corresponds to the origin. The probability of exceeding the average power is plotted between 0.0001% and 100% on the Y axis. The recording depth is 8kSamples.

This signal is picked off at the output of the baseband main module (**Impairment** function block). Impairment of the signal as defined by the user and the addition of noise is not effective in this signal because signal impairment and noise addition occur further down the signal path.

The point at which the CCDF curve intersects the X axis gives the crest factor of the signal.

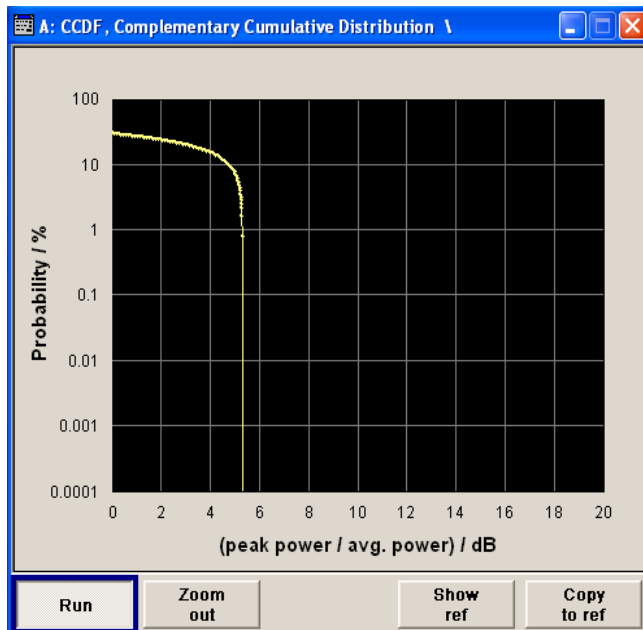

## Power Spectrum - Graphics

With the spectrum display, the signal spectrum is calculated from the I/Q signal by means of Fast Fourier Transform (FFT).

The power density over frequency is displayed. The power density is plotted on the Y axis, and the frequency is plotted symmetrically on the X axis (-sampling rate/2 to +sampling rate/2). FFT Points indicates the number of I/Q value pairs which are used for calculating a (part-)FFT. AVG indicates the number of subspectra used for averaging. The recording depth is 8kSamples.

This signal is picked off at the output of the baseband main module (**Impairment** function block). Impairment of the signal as defined by the user and the addition of noise is contained in the displayed signal.

The spectrum display of the output signal is particularly suitable for checking multicarrier signals.

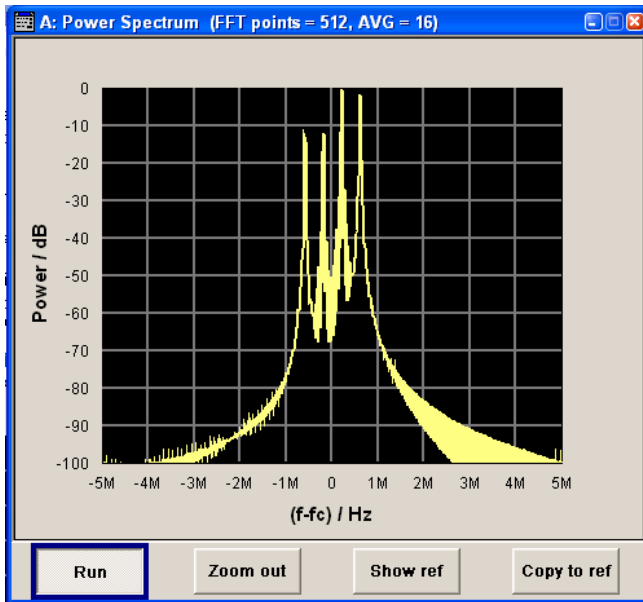

# RF Signal and Analog Mod - A Mod-RF A

## Overview of RF Signal and Analog Modulations

Settings for the RF output signal and analog modulation are made under "RF Signal and Analog Modulations". These settings can be accessed in the block diagram by way of the **RF/A MOD** function block, or by means of the menu with the same name which is opened using the **MENU** key.

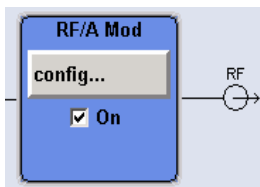

The function block is available for the basic unit (R&S SMATE + frequency option R&S SMATE-B10x) without additional equipment options. An additional frequency option (R&S SMATE 20x) is required for a two-path instrument.

For instruments with frequency option R&S SMATE-B10x it is possible to install the options and/or **High Power** (R&S SMATE-B3x options) separately for both RF paths.

The RF output signal can be activated and deactivated directly using the **TOGGLE ON/OFF** key (the function block must be highlighted beforehand).

The **RF ON/OFF** key (CTRL+R) can also be used to activate and deactivate the output signal (here, however, the current entry focus is irrelevant). Both RF output signals are always deactivated in the case of two-path instruments. The previous state is restored when the signals are reactivated.

Remote-control commands:

```
OUTP:STAT OFF
OUTP:ALL:STAT OFF
```

The activated and deactivated state is indicated in the block diagram by means of the different block color and the status of the **On** checkbox. The disconnected connection to the output is additionally shown when the output is deactivated. Active analog modulation is also indicated in the block.

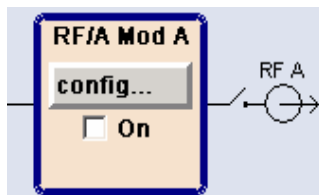

The RF output state can also be set in the **Configure** menu of the RF /MOD block.

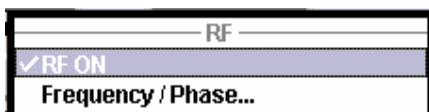

Remote-control command:

```
OUTP:STAT OFF
```

The CW, Sweep and List modes are available for generating the RF signal.

<b>CW</b>	The RF signal is generated with the set frequency and level. This is the default mode.
<b>Sweep</b>	The RF signal is generated as a sweep with the set parameters. It is possible to activate frequency, level and LF sweep simultaneously.
<b>List Mode</b>	The RF signal is generated on the basis of a list of predefined frequency and level values. The duration of the individual steps can be predefined.

Instruments connected downstream can be taken into consideration when setting the frequency and level by entering a frequency and/or level offset.

Automatic level control ensures maximum level accuracy, even with I/Q modulation.

User-specific lists which contain level correction values for any frequency range (User Correction) can be created to, for example, compensate the cable attenuation in a test assembly setup.

The RF signal can be generated in unmodulated or analog form. An internal LF generator and/or the external modulation input EXT MOD at the rear of the instrument is available as the source for the analog modulations.

An external trigger signal for the analog modulations, the sweeps and the LIST mode can be provided for both paths separately at the two INST TRIG inputs. The BNC connector INST TRIG is assigned to Path A, and the pin INST TRIG B of the AUX I/O interface is assigned to Path B. The input REF IN is used to input an external instrument reference, and the output REF OUT serves as the output of the reference frequency (internal or external).

The RF signals in the case of two-path instruments are generated independently of each other. Both RF paths are, however, synchronized to the same reference frequency (internal or external).

## RF Frequency and Phase - Frequency - Phase

The simplest way to set the RF frequency is to enter it directly in the header of the display.

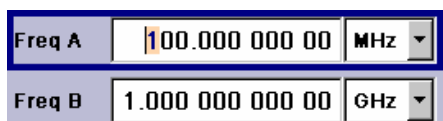

The entry is activated by pressing the **FREQ** key (CTRL+F). In the case of two-path instruments, pressing this key again activates entry of the frequency for Path B. Changes to the frequency have an immediate effect (without confirmation with the Enter key) on the output signal of the respective path.

Remote-control command

```
SOUR:FREQ 100 MHz
```

---

### Note:

The IEC/IEEE-bus command sets the level of the **Freq** display, i.e. an entered frequency offset is taken into consideration in the frequency value (see below).

---

The frequency entered and displayed in the frequency field takes any set frequency offset into consideration, e.g. an offset set for a downstream instrument. This means that with a frequency offset the frequency displayed in the header does not correspond to the frequency at the RF output, but rather to the frequency at the output of the downstream instrument. A set frequency offset is indicated by the **FREQ OFFSET** status message.

This allows the desired frequency at the output of a downstream instrument to be entered in the frequency field. The R&S Vector Signal Generator changes the RF output frequency according to the entered offset.

However, the frequency entered and displayed in the **Frequency/Phase** menu of the **RF/Ana Mod** function block always corresponds to the RF output frequency. Any frequency offset is not taken into consideration.

The correlation is as follows:

$$\text{Freq in header} = \text{RF output frequency} (= \text{Freq in menu}) + \text{Freq offset} (= \text{Offset in menu})$$

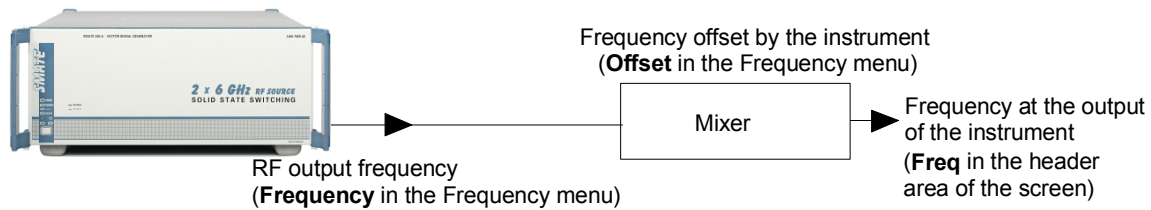

The frequency offset is entered in the **Frequency/Phase** menu. Here it is also possible to set the frequency without taking the offset into consideration, to set the step width for the frequency entry using the rotary knob, and to set the phase for the RF output signal.

## Frequency - Phase Menu

The **Frequency/Phase** menu is opened either in the **RF/A Mod** function block or using the **MENU** key (CTRL+M) under **RF/A Mod**.

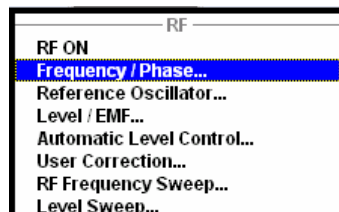

Frequency and phase of the RF output signal are set in the upper part of the group menu. The lower parts concern the settings of the reference oscillator and are described in the section "[RF Reference Frequency - Reference Oscillator](#)", page 4.47.



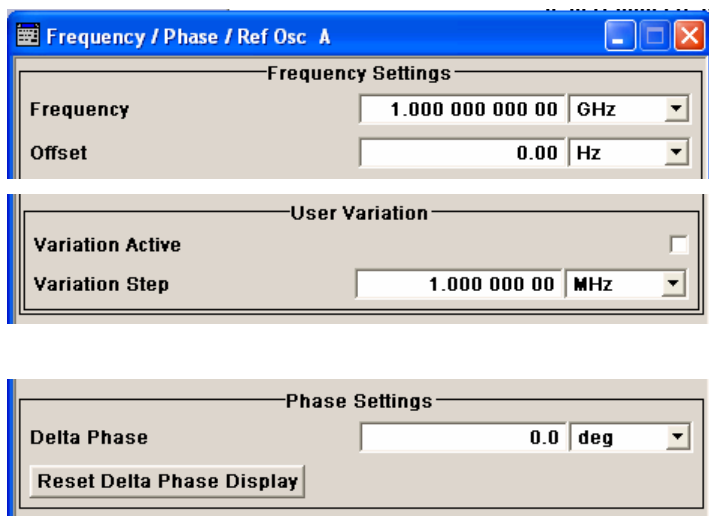

The frequency and offset are set in the top section of the menu.

The step width which is used when setting the frequency using the rotary knob (with **Variation Active On**) is set in the **User Variation** section.

The phase of the output signal can be changed in the **Phase Settings** section.

The frequency and offset are set in the top section of the menu.

#### Frequency - RF Signal

Sets the RF frequency of the RF output connector. The frequency entered and displayed here corresponds to the frequency at the RF output, i.e. any offset entry is not taken into consideration.

Remote-control command: n.a.

---

#### Note:

*The IEC/IEEE-bus command `SOUR:FREQ` sets the frequency of the **FREQ** display, i.e. the frequency containing offset.*

---

#### Frequency Offset - RF Signal

Sets the frequency offset relative to the RF frequency. The frequency offset of a downstream instrument (e.g. a mixer) is entered.

The entry does not change the value of the RF frequency at the RF output. It only changes the RF frequency displayed in the display header. The value of the RF frequency in the header corresponds to the frequency.

Remote-control command:

`SOUR:FREQ:OFFS 0 Hz`

If the frequency is set using the rotary knob, the step width is defined in the **User Variation** section.

**Variation Step - RF Signal** Sets the user-defined step width. This step width is used when entering the RF frequency using the rotary knob. Frequency variation with this step width must also be activated with **Variation Active**.

Remote-control command:  
SOUR:FREQ:STEP 1 MHz

**Variation Active - RF Signal** Activates the user-defined step width used when varying the frequency value with the rotary knob.

**ON** The frequency value set with the rotary knob is varied using the user-defined step width which is entered under **Variation Step**.

Remote-control command:  
SOUR:FREQ:STEP:MODE USER

**OFF** The frequency value set with the rotary knob is varied in steps of one unit at the cursor position (standard operating mode).

Remote-control command:  
SOUR:FREQ:STEP:MODE DEC

The phase of the RF output signal can be changed in the **Phase Settings** section.

**Delta Phase - RF Signal** Sets the phase of the RF signal. The current phase of the signal is used as the reference. This function allows, for example, the phase of the output signal to be synchronized with the phase of a signal from a second signal generator.

Remote-control command:  
SOUR:PHAS 10 DEG

**Reset Delta Phase Display - RF Signal** Resets delta phase value. The set phase is adopted as the new current phase, i.e. the delta phase value is reset to 0.

Remote-control command:  
SOUR:PHAS:REF

## RF Reference Frequency - Reference Oscillator

In the internal reference mode the internal reference signal is available at the REF OUT connector (rear of instrument). The frequency of the internal reference signal is permanently set to 10 MHz. The frequency of the internal reference oscillator can be impaired by means of the EXT TUNE input (AUX I/Q connector at rear of instrument) (**Frequency Adjustment**; see data sheet for technical information). External impairment is possible in both **Adjustment State** states (**On** or **Off**).

In the external reference mode an external signal with selectable frequency and defined level must be input at the REF IN connector. This signal is output at the REF OUT connector. The **EXT REF** status message appears in the display header.

The reference frequency setting is effective for both paths.

### Reference Oscillator Menu

The **Reference Oscillator** menu is opened either in the **RF/A Mod** function block or using the **MENU** key under **RF/A Mod**.

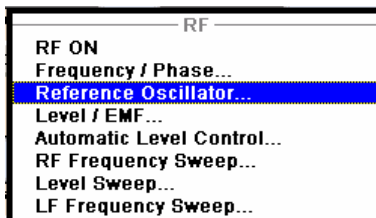

The reference oscillator is set in the lower areas of the group menu. The three upper areas are for setting the frequency and phase of the RF output signal; see section "[RF Frequency and Phase - Frequency - Phase](#)", page 4.43.



....

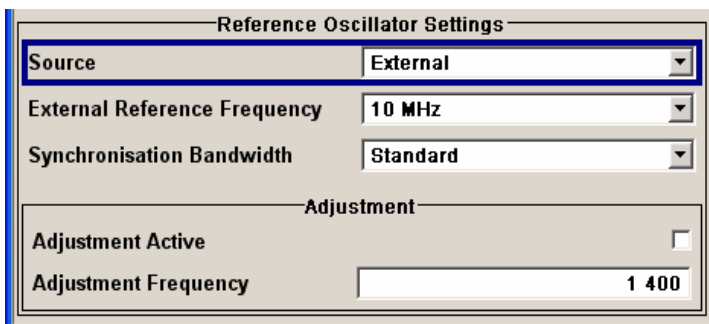

The menu is used to select the source, to enter the frequency of an external reference signal and to adjust the reference frequency.

**Source - Reference Oscillator**

Selects the source of the reference frequency.

**Internal**

The internal reference signal of 10 MHz is used.

Remote-control command:  
SOUR:ROSC:SOUR INT

**External**

An external reference signal is used. The frequency of the external reference signal must be selected under **External Frequency**.

Remote-control command:  
SOUR:ROSC:SOUR EXT

**Synchronization Bandwidth - RF Signal**

(Source External only) Selects the synchronization bandwidth for an external reference signal. The wideband setting is provided for using very good reference sources of high spectral purity.

**Narrow**

Synchronization bandwidth is 1 Hz.

Remote-control command:  
SOUR:ROSC:EXT:SBAN NARR

**Wide**

Synchronization bandwidth is 750 Hz.

Remote-control command:  
SOUR:ROSC:EXT:SBAN WIDE

**External Reference Frequency - RF Signal**

Selects the external reference signal.

Remote-control command:  
SOUR:ROSC:EXT:FREQ 13E6

**Adjustment State - Reference Oscillator**

Selects adjustment mode.

**Off**

The calibrated adjustment value of the internal reference frequency is used. This value is determined at one of the R&S service shops during calibration.

Remote-control command:  
SOUR:ROSC:INT:ADJ:STAT ON

**On**

A user-defined adjustment value is used. The value is entered under **Adjustment Frequency**.

This allows the frequency to be impaired freely, for example to simulate a frequency error.

The instrument is no longer in the calibrated state.

Remote-control command:  
SOUR:ROSC:INT:ADJ:STAT OFF

**Adjustment Frequency - RF Signal** Enters a user-defined adjustment value for the internal reference frequency. This value is not used unless **Adjustment Active On** is selected.

Remote-control command:  
SOUR:ROSC:INT:ADJ:VAL 1400

## RF Level - Level - EMF

### Note:

The message **Level overrange/underrange** appears in the status line if the set level (**Level**) or the displayed peak envelope power (**PEP**) (Digital Modulation or Digital Standard) is in the overrange (see data sheet). The correct level setting cannot be guaranteed for the entire frequency range if the set level is in the overrange/underrange.

The simplest way to set the RF level is to enter it directly in the header of the display.

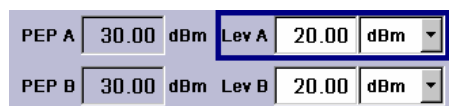

The entry is activated by pressing the **LEVEL** key. In the case of two-path instruments, pressing this key again activates entry of the level for Path B. Changes to the level have an immediate effect (without confirmation with the Enter key) on the output signal of the respective path.

Remote-control command:  
SOUR:POW:LEV:IMM:AMPL -30 dBm

### Note:

The IEC/IEEE-bus command sets the level of the **Level** display, i.e. an entered level offset is taken into consideration in the level value (see below).

The center line (**Level**) and, to the left of this, the peak envelope power (**PEP**) of the modulated RF output signal is displayed in the case of digital modulation or digital standard.

A two-line display appears in the case of two-path instruments. The frequency and level of Path A are shown in the top line, and the frequency and level of Path B in the bottom line.

dBm, dBμV, mV and μV can be used as the level units. The 4 unit keys are labeled with these units.

The level entered and displayed in the Level field takes the offset of any downstream attenuators/amplifiers into consideration by way of calculation. This means that with a level offset the level displayed in the header does not correspond to the level at the RF output, but rather to the level at the output of the downstream instrument.

This allows the desired level at the output of downstream instruments to be entered. The R&S Vector Signal Generator changes the RF output level according to the set offset.

However, the level entered and displayed in the **Level** menu of the **RF/Ana Mod** function block always corresponds to the RF output level. Any level offset is not taken into consideration.

The correlation is as follows:

$$\text{Level in header} = \text{RF output level} (= \text{Level in menu}) + \text{Level offset}$$

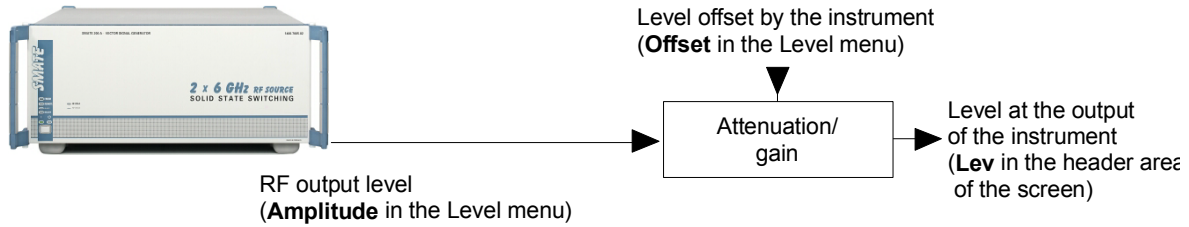

The level offset is entered in the **Level** menu. Here it is also possible to set the level without taking the offset into consideration, and to make other settings, such as level offset, attenuator mode, power-on state.

## Level - EMF Menu

The **RF Level - EMF** menu is opened either in the **RF/Ana Mod** function block or using the **MENU** key (CTRL+M) under **RF/Ana Mod**.

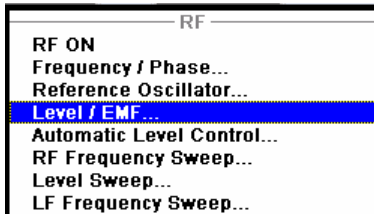

The top sections of the combined menu **Level / EMF / ALC /UCOR** provide access to the level and attenuator settings. The lower sections provide access to the automatic level control settings, see section "[Automatic Level Control - ALC](#)", page 4.55. and to function User Correction, see section "[User Correction](#)", page 4.61.

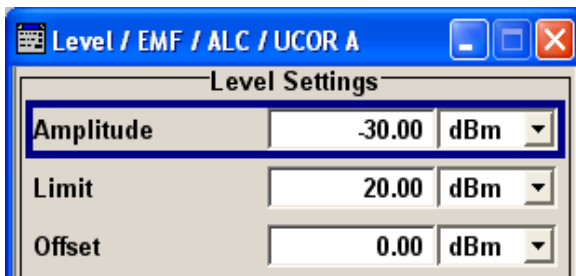

The offset-free level, attenuation mode, level offset and level limit are set in the top section of the menu.

The screenshot shows four menu sections:

- Attenuator Settings:** Mode is set to Auto.
- User Variation:** Variation Active is unchecked. Variation Step is 1.00 dBm.
- Miscellaneous:** RF/MOD On/Off Connector is checked (Enable).
- Power-On / EMF Settings:** Power-On State is Previous Setting. Display Level as Voltage of EMF is unchecked.

The attenuator is set in the **Attenuator Settings** section.

The step width which is used when setting the level using the rotary knob (with **Variation Active On**) is set in the **User Variation** section.

The hardware control lines on the Digital I/O interface at the rear of the instrument are activated in the **Miscellaneous** section.

The power-on behavior of the R&S Vector Signal Generator and the level display in the display header are set in the **Power-On / EMF Settings** section.

The offset-free level, attenuation mode, level offset and level limit are set in the top section of the menu.

#### Amplitude - RF Signal

Sets the RF level of the RF output connector.

The level entered and displayed here corresponds to the level at the RF output, i.e. any offset entry is not taken into consideration.

Remote-control command: n.a.

---

#### Note:

*The IEC/IEEE-bus command `SOUR:POW:LEV:IMM:AMPL` sets the level of the **Level display**, i.e. the level containing offset.*

---

#### Limit - RF Signal

Sets the level limit.

The value specifies the upper limit of the level at the RF output connector. A message appears if an attempt is made to set a level above this limit and the level at the RF output is confined to the upper limit. However, the level indication is not influenced.

Remote-control command:

`SOUR:POW:LIM:AMPL 30 dBm`

**Level Offset - RF Signal**

Sets the level offset relative to the RF level.

The level offset of a downstream instrument (e.g. an attenuator or amplifier) is entered.

The entry does not change the value of the RF level at the RF output. It only changes the RF level displayed in the display header. The value of the RF level in the header corresponds to the level at the output of the downstream instrument.

Remote-control command:

SOUR:POW:LEV:IMM:OFFS 0

The attenuator mode is set in the **Attenuator Settings** section.

**Attenuator Mode - RF Signal**

Sets the attenuator mode at the RF output.

The selection of Normal and High Power is only available when the instrument is equipped with the high-power output option (R&S SMATE-B31 or R&S SMATE-B36).

**Auto**

Standard mode. The electronically switching attenuator switches with a 5 dB step width at fixed switching points.

**With high-power output option:**

The entire level range is available. The level settings are made in the area of the electronically switching attenuator as well as the relay-switched option (longer switchover time, wear).

Remote-control command:

OUTP:AMOD AUTO

**Normal  
(Option High Power only)**

The level settings are made only in the area of the electronically switching attenuator. The high level ranges are not available.

This setting is wear-free, as the relays are not switched.

Remote-control command

OUTP:AMOD NORM

**High Power  
(Option High Power only)**

The level settings are made only in the area of the option. Only the high level range is available. The relays are not switched.

Remote-control command

OUTP:AMOD HPOW



**Fixed**

The level settings are made without switching the attenuator and the high-power output option. When this operating mode is switched on, the attenuator and the option are fixed in their current positions and the resulting variation range is defined. The range is displayed under **Attenuator Fixed Range**.

If automatic level control is activated (**ALC State = On**), the level settings are made without interruption.

If the normal variation range is overranged or underranged, level errors increase considerably and the warning **Level under/overrange** appears in the info line. The spectral purity of the output signal decreases with high attenuation.

Remote-control command:

OUTP:AMOD FIX

**Attenuator Fixed Range**

Displays the level range in which the level is set without interruption for the "**Attenuator Mode fixed**" setting.

Remote-control commands:

OUTP:AFIX:RANG:UPP?

OUTP:AFIX:RANG:LOW?

If the level is set using the rotary knob, the step width is defined in the **User Variation** section.

**Variation Step - RF Level**

Sets the user-defined step width for entering the RF level using the rotary knob. Level variation with this step width must also be activated with **Variation Active**.

Remote-control command:

SOUR:POW:STEP:INCR 1dBm

**Variation Active - RF Level**

Activates the user-defined step width used when varying the level value with the rotary knob.

**ON**

The level value set with the rotary knob is varied using the user-defined step width which is entered under **Variation Step**.

Remote-control command:

SOUR:POW:STEP:MODE USER

**OFF**

The level value set with the rotary knob is varied in steps of one unit at the cursor position (standard operating mode).

Remote-control command:

SOUR:POW:STEP:MODE DEC

The hardware control lines on the Digital I/O interface at the rear of the instrument are activated in the **Miscellaneous** section.

**RF/MOD On/Off Connector  
- RF Level**

Activates hardware control lines RF OFF and MOD OFF on the Digital I/O interface at the rear of the instrument.

The R&S SMATE provides hardware control lines on the Digital I/O interface at the rear of the instrument. They can be used for fast access to several instrument functions:

Outputs OPC A/B (pin 39 and 42) are always active. Active High (1) indicates that all remote control commands of the respective path are executed.

Inputs RF OFF A/B (pin 40 and 43) provide fast switching of the RF Output (10  $\mu$ s). They must be activated prior to use. For the control signals to take effect, the RF Output must be switched on when the inputs are activated.

Active High (1) switches the RF Output off. A subsequent Active Low (0) switches the RF Output on again.

The attenuation of the switched off output is considerably less than after regular switch-off, because the connection between the RF output and attenuator is not interrupted.

Inputs MOD OFF A/B (pin 41 and 44) provide fast switching of the I/Q Modulator (10  $\mu$ s). They must be activated prior to use. For the control signals to take effect, the modulations must be switched on when the inputs are activated.

Active High (1) switches the modulations off. A subsequent Active Low (0) switches the modulations on again.

The control signal has no effect on the status of the digital modulations in the baseband block or of the analog modulation of the RF block. An exception is broadband amplitude modulation which uses the I/Q modulator.

Remote-control command:  
:SOUR:INP:CONT:RFM ON

The power-on behavior of the R&S Vector Signal Generator and the level display in the display header are set in the **Power-On /EMF Settings** section.

**Power-On State - RF Signal** Selects the state which the RF output is to assume after the instrument is switched on.

**RF Off** The output is deactivated when the instrument is switched on.

Remote-control command:  
OUTP:PON OFF

**Previous Setting** When the instrument is switched on, the output assumes the same state as it had when the instrument was switched off.

Remote-control command:  
OUTP:PON ON

**Display Level as Voltage  
EMF - RF Level**

Activates display of the signal level as voltage of the EMF (no-load voltage). If this setting is deactivated, the level is displayed as a voltage with 50  $\Omega$  (presetting).

Remote-control command: n.a.

## Automatic Level Control - ALC

Automatic level control (**Automatic Level Control**) can be used with almost all applications, especially I/Q modulation and amplitude modulation. It only has to be deactivated for certain settings in the baseband and when I/Q impairments (**Impairments State On**) are activated. This is indicated under the respective function.

The level control status is permanently displayed as a status message in the info line.



The standard operating status is level control **On**. This provides the highest level accuracy. The preset is **Auto**. In this mode the level control is automatically adapted to the operating conditions.

Level control can be switched to **Sample&Hold** or **On** for particular applications. The **Sample&Hold** state (level control Off) is recommended if in CW mode the signal/intermodulation ratio is to be improved for multi-transmitter measurements.

If **Sample&Hold** is selected, the level is recalibrated for every level and frequency setting. For this purpose, level control is activated briefly at a defined signal, the level adjuster is then held at the attained value and level control is activated.

If **On** and **Attenuator Mode Fixed** is selected, the level is recalibrated for every level and frequency setting. For this purpose, level control is activated briefly at a defined signal, the level adjuster is then held at the attained value and level control is activated the uninterrupted level settings are made.

## Automatic Level Control Menu

The **Automatic Level Control** menu is opened either in the **RF/A Mod** function block or using the **MENU** key under **RF/A Mod**.

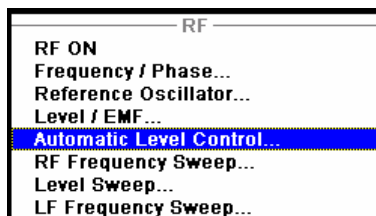

The combined menu Level / EMF / ALC /UCOR provides access to the automatic level control settings in the lower section. The top sections provide access to the level and attenuator settings, see section "[RF Reference Frequency - Reference Oscillator](#)", page 4.47, the bottom section to function User Correction, see section "[User Correction](#)", page 4.61.

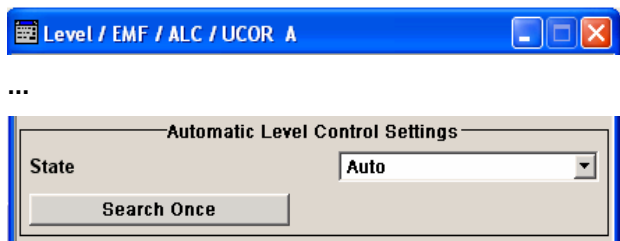

This menu is used to activate level control.

**State - ALC**

Activates/deactivates internal level control.

**Sample&Hold**

Internal level control is deactivated.

Remote-control command:

```
SOUR:POW:ALC OFF
SOUR:POW:ALC:OMOD SHOL
```

**Auto**

Default state. Level control is automatically adapted to the operating states.

Remote-control command:

```
SOUR:POW:ALC AUTO
```

**On**

Internal level control is permanently activated.

Remote-control command:

```
SOUR:POW:ALC ON
```

**Search Once - ALC**

Manually activates level control briefly to allow the level to be calibrated (the **Sample&Hold** setting must be selected).

Remote-control command:

```
SOUR:POW:ALC:SONC
```

## Power Sensors

Up to three R&S NRP Power Sensors can be connected to the generator. The SENSOR connector for the first R&S NRP Power Sensor is on the front panel, a second and third R&S NRP Power Sensor can be connected via the USB interfaces (front and rear panel, requires USB adapter R&S NRP-Z3 or R&S NRP-Z4). The connected R&S NRP Power Sensors are automatically detected and indicated in the **Power Sensors** menu.

The average signal power is continuously measured by the R&S NRP Power Sensor(s) and indicated in the Power Sensors menu (**Power Viewer**). The output signals of the two RF signal paths or any freely selectable source can be measured.

The R&S NRP Power Sensor can be used to acquire level correction data used to create and activate lists in which level correction values predefined by the user are freely assigned to RF frequencies. Correction is performed by the user-defined table values being added to the output level for the respective RF frequency (see [User Correction](#), on page 4.61).

## Power Sensors Menu

The **Power Sensor** menu is opened either in the **RF/A(B) Mod A(B)** function block or using the **MENU** key under **RF/A(B) Mod A(B)**. The menu is structured like a table showing the values for sensor 1 in the left "column" and the values of the second/third sensor in the middle/right "column". Only the detected sensors are indicated, i.e. if only one sensor is connected only one column is indicated. The sensor connected to the SENSOR port is always indicated as sensor 1, and the sensors connected to the USB interface are always indicated as sensor 2 and 3.

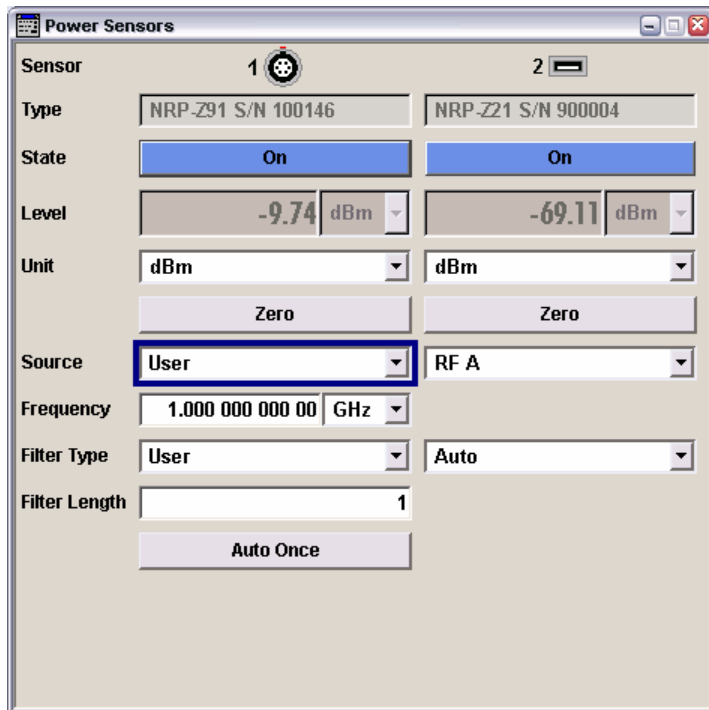
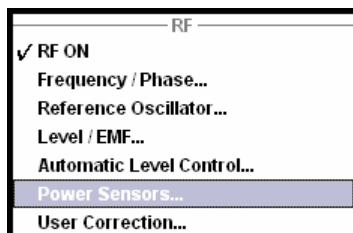

<b>Sensor - Power Sensors</b>	<p>Indicates the connector used for the detected sensors. The values listed below belong to the respective sensor.</p> <p>Remote-control command: SENS:STAT? Response. 1</p> <p>The sensor is selected by suffix <b>1</b>, <b>2</b> or <b>3</b> in key word SENSE or READ of the command header. Suffix 1 denotes the sensor connected to the SENSOR connector, suffix 2 the sensor connected first to one of the USB interfaces and suffix 3 the sensor connected second to one of the USB interfaces.</p>
<b>Type - Power Sensors</b>	<p>Indicates the type of the connected R&amp;S NRP Power Sensor. The sensor type is automatically detected.</p> <p>Remote-control command: SENS:POW:TYPE?</p>
<b>State - Power Sensors</b>	<p>Activates/deactivates level measurement by the power sensor.</p> <p>Remote-control command: n.a. The level acquisition is enabled by the READ command.</p>
<b>Level - Power Sensors</b>	<p>Indicates the measured level value with the selected unit.</p> <p>Remote-control command: READ:POW?</p>
<b>Unit - Power Sensors</b>	<p>Selects the unit used for result display.</p> <p>The power sensor provides the measured value in Watt.</p> <p>In which unit the measured value is indicated is selected here and might be either Watt, dBm or dBuV.</p> <p>Remote-control command: SENS:UNIT:POW DBM</p>

**Zero - Power Sensors**

Activates the autozero function.

Zeroing is required in regular interval (e.g. once a day), if the temperature has varied more than about 5 °C, if the sensor has been replaced or if measurements of signals with very low power are to be performed.

The sensor must be disconnected from all power sources before starting the autozero function.

Remote-control command:

```
SENS:POW:ZERO
```

**Source - Power Sensors**

Selects the RF path for measurement. The sensor is set to the frequency of the selected path.

If two sensors are connected, both sensor can be allocated the same path, e.g. for measurements before and after the DUT.

In addition, setting **User** can be selected for measurements of any freely selectable source. The frequency is entered manually under frequency (e.g. for measurement of amplifier gain with 2 sensors).

Remote-control command:

```
SENS:POW:SOUR USER
```

**Frequency - Power Sensors****Source User only**

Enters the frequency for measurement source User.

Remote-control command:

```
SENS:POW:FREQ 2.5MHz
```

**Filter Type - Power Sensors**

Selects the filter length used for measurement. The averaging filter is used to reduce fluctuations in the measured result to the extent desired. Such fluctuations can be caused by inherent noise of the measuring instrument, modulation of the measurement signal or beats from the superposition of adjacent carriers. A more stable display has to be traded off against longer measurements. The measurement result is obtained from a two-stage averaging process.

---

**Note:**

*Longer measurements does not mean that it takes longer to display a new result, but rather that it takes longer for the result to settle when the power changes.*

---

Measurements are continuously repeated in a predefined time window. The measurement result is obtained by averaging the measured values for the last 2N time windows. The number N is the filter length, the factor of 2 arises because the output signals from the microwave detector to suppress low-frequency noise are chopped at the same rate as the time windows, which means that an independent measured value can only be obtained from two consecutive values. As the filter length is the multiplier for the time window it directly influences the measurement time.

The filter length can be selected automatically or can be manually set to a fixed value. As a preliminary, you should always check if the auto mode is giving satisfactory results because you will always have to adjust an optimal, manual filter-length setting if the power is not constant.

**Auto**

The filter length is automatically selected and adapted to the currently measured value. With very high signals the filter length and therefore the measurement time can be short. With very low signal levels the filter length and therefore the measurement time is increased in order to reduce noise.

Remote-control command:

SENS:POW:FILT:TYPE AUTO

**User**

The filter length is set manually.

Remote-control command:

SENS:POW:FILT:TYPE USER



**Filter Length - Power Sensors****Filter User** only

Sets the filter length manually. As the filter length works as a multiplier for the time window, this results in a constant measurement time. Values 1 and 2<sup>n</sup> are settable.

**Note:**

*The time window varies in manual control, it is fixed to 20 ms in remote control.*

Remote-control command:

```
SENS:POW:FILT:LENG 16
```

**Auto Once - Power Sensors**

Activates the search for the optimum filter length for the current measurement conditions. The found filter length is indicated in the **Filter Length** field above.

Remote-control command:

```
SENS:POW:FILT:SONC
```

## User Correction

The "User Correction" function is used to create and activate lists in which level correction values predefined by the user are freely assigned to RF frequencies. Correction is performed by the user-defined table values being added to the output level for the respective RF frequency.

With frequencies which are not contained in the list, the level correction is determined by interpolation of the closest correction values.

The lists are created in the List Editor. Each list is stored in its own file with the predefined file extension \*.uco. The name of the User Correction file can be freely selected. The files are loaded from the **Lists...** file manager. Externally created tables with pairs of frequency and level values can be converted into User Correction files using the import function. The external files must have the file extension \*.txt or \*.csv. These file formats are provided e.g. by the Microsoft Excel program. The separators for table columns and for decimal floating-point numerals can be set. In addition, internally created User Correction data can be exported into ASCII files using the export function.

The amplitude can also be linearized automatically by means of a R&S NRP Power Sensor connected to one of the generator output signals. With the aid of the **Fill with Sensor** function, a table with correction values for external test assemblies can be automatically determined, e.g. for compensating the frequency response of cables. The User Correction list with the correction values acquired by the sensor is generated in the **Edit User Correction List** menu. The correction values can be acquired any time irrespective of the modulation settings of the generator.

If user correction is activated, the **UCOR** display (User Correction) is shown in the header together with the **Level** display. The RF output level is the sum of both values.

$$\text{Level} + \text{UCOR} = \text{Output level}$$

If activated, user correction is effective in all operating modes.

## User Correction Menu

The **User Correction** menu is opened either in the **RF/A Mod** function block or using the **[MENU]** key under **RF/A Mod**.

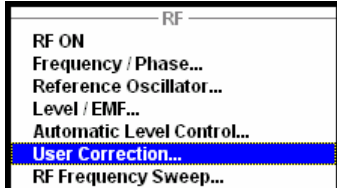

The combined menu Level / EMF / ALC /UCOR provides access to the automatic level control settings in the bottom section. The top sections provide access to the level and attenuator settings, see section "*RF Reference Frequency - Reference Oscillator*", page 4.47, and to the automatic level control settings, see section "*Automatic Level Control - ALC*", page 4.55.

The menu is used to activate/deactivate user correction, and to create, select and activate the lists.



The menu is used to activate/deactivate user correction, and to create, select and activate the lists.

### State - User Correction

Activates/deactivates user correction.

The **UCOR** status message appears in the frequency and level display.

Remote-control command:

SOUR:CORR:STAT ON

### Value - User Correction

Indicates the current value for level correction.

Remote-control command:

SOUR:CORR:VAL?

**User Correction Data - User Correction** Calls the **File Select** menu for selecting and creating a list or the **File Manager**.

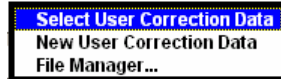

Remote-control command:

SOUR:CORR:CSET:CAT?

Response:

'Ucor1', 'Ucor2'

SOUR:CORR:CSET:SEL 'Ucor1'

SOUR:CORR:CSET:DEL 'Ucor2'

**Edit User Correction Data - User Correction** Calls the editor for editing the selected user correction list. A list consists of any number of frequency/level value pairs. The currently selected list is displayed.

**Important:**

*Save list only after filling both columns (frequency and level), otherwise the entries are lost.*

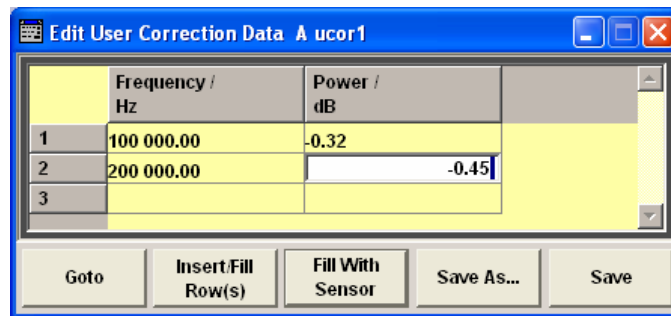

**Frequency /Hz** Enters the frequency to which the level correction value applies.

**Note:**

*Using the Fill With Sensor function requires only entry of the frequency values. The level values are automatically acquired by the connected power sensor.*

Remote-control command:

SOUR:CORR:CSET:SEL 'Ucor1'

SOUR:CORR:CSET:DATA:FREQ 100MHz,...

**Power /dB** Enters the level correction value to which the specified frequency applies. The values can be entered manually or automatically with the **Fill With Sensor** function .

Remote-control command:

SOUR:CORR:CSET:SEL 'Ucor1'

SOUR:CORR:CSET:DATA:POW 1dB,0.8dB,...

**Goto**

Selects row for editing.



If Goto row is selected, a window opens for entering the requested row.

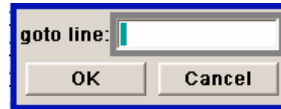

Remote-control command: n.a.

(it is not possible to change individual positions of the list)

**Fill With Sensor**

Calls the menu to activate the filling of the user correction list with level values acquired by the selected power sensor. All level correction values for the given frequency values in the left column are entered in the selected list. The list is automatically stored and recalled again after filling.

The menu indicates the relevant generator settings. The RF source (RF A or RF B) is defined by the path for which the correction menu settings are made. Only the sensor can be selected in the **Sensor** field of the menu.

The **Execute** button is only enabled if a sensor is detected and the user correction list contains at least one frequency value.

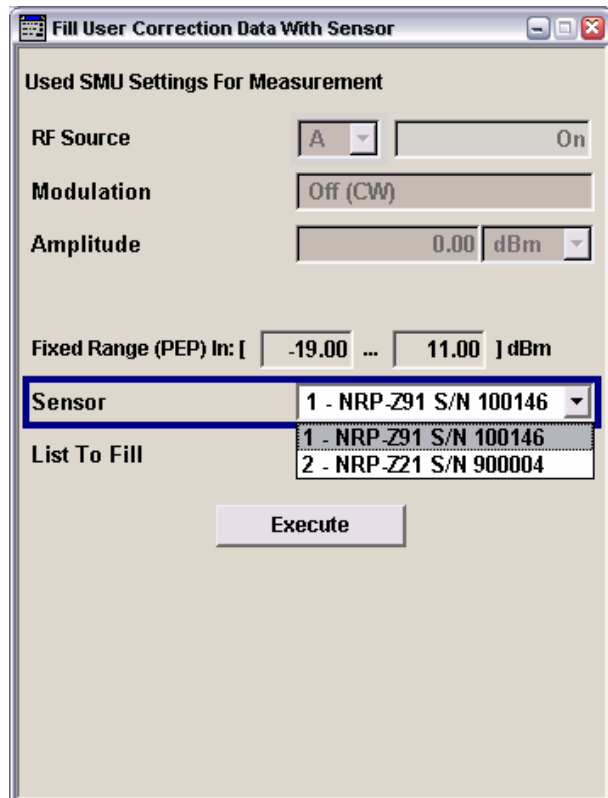

Remote-control command:

CORR:CSET:DATA:SENS:POW:SONC

(the power sensor used is selected by the suffix in key word SENSE of the command header. Suffix 1 denotes the sensor connected to the SENSOR connector, suffix 2 the sensor connected first to one of the USB interfaces and suffix 3 the sensor connected second to one of the USB interfaces.)

**Insert Row(s)**

Insert a new row before the marked row.

Remote-control command: n.a .

**Save as**

Open the file menu to save the list under a new name.

Each list is saved to the R&S Vector Signal Generator hard disk as a separate file with the file prefix \*.uco. The file name and the directory to which the file is saved are user-selectable.

Remote-control command: -

**Save**

The list is saved under its current name.

Remote-control command: -

(the list is automatically saved after the values have been entered)

User correction list can be imported from externally created files or exported into text or CSV-files. The import/export settings are available after clicking the **Import/Export** button.

**Import/Export - User Correction**

Expands the menu with the area for import and export of user correction files.

Externally edited Excel tables with frequency/level pairs can be imported as text or CSV-files and used for user correction.

On the other hand, internally created user correction list can be exported as text or CSV-files.

**Mode - User Correction**

Selects if user correction lists should be imported or exported. The settings offered depend on the selected mode.

Remote-control command:

SOUR:CORR:DEXC:MODE IMP

**Extension - User Correction**

Selects the file extension of the ASCII file to be imported or exported. Selection TXT (text file) or CSV (Excel file) is available.

Remote-control command:

SOUR:CORR:DEXC:AFIL:EXT TXT

**Decimal Point - User Correction**

Selects the decimal separator used in the ASCII data between '.' (decimal point) and ',' (comma) with floating-point numerals.

Remote-control command:

SOUR:CORR:DEXC:AFIL:SEP:DEC DOT

**Column Separator- User Correction**

Selects the separator between the frequency and level column of the ASCII table the user correction list is exported to or imported from.

Remote-control command:

SOUR:CORR:DEXC:AFIL:SEP:COL TAB

### Select ASCII Source / Destination - User Correction

Calls the **File Manager** for selecting the ASCII file to be imported into a user correction list (source) or the ASCII file the user correction list is exported (destination) in.

Remote-control command:

```
SOUR:CORR:DEXC:AFIL:SEL "C:/user/ucor/list1.txt"
```

### Destination / Source - User Correction

Calls the **File Manager** for selecting the user correction list to be exported (source) into an ASCII file or the destination for the ASCII file to be imported (destination) in.

Remote-control command:

```
SOUR:CORR:DEXC:SEL "C:/user/ucor/list1.txt"
```

### Import / Export - User Correction

Starts the export or import of the selected file.

When import is selected, the ASCII file is imported as user correction list.

When export is selected, the user correction list is exported into the selected ASCII file.

Remote-control command:

```
SOUR:CORR:DEXC:EXEC
```

## List Mode - List

Similar to a sweep, a series of previously defined frequency and level points is processed in List mode. In contrast to a sweep, however, a list with freely selectable value pairs (frequency and level) can be created. The value range for frequency and level covers the entire configurable value range of the instrument.

---

### Note:

*List mode and sweeps can not be activated simultaneously, they deactivate each other.*

---

The lists can be created in the List Editor. Each list is stored in its own file with the predefined file extension \*. **lsw**. The name of the List file can be freely selected. The files are loaded from the **Lists...** file manager. Externally created tables with pairs of frequency and level values can be converted into List files using the import function. The external files must have the file extension \*.txt or \*.csv. These file formats are provided e.g. by the Microsoft Excel program. The separators for table columns and for decimal floating-point numerals can be set. In addition, internally created List data can be exported into ASCII files using the export function.

The necessary hardware settings are calculated the first time a list is processed. With long dwell times, this calculation can be performed while the list is being processed; the entered dwell times are observed. With very short dwell times, calculation of the hardware settings increases the dwell time for the initial processing cycle; the entered value is only observed from the second processing cycle onwards. In this case a message appears to inform the user that there is a deviation between the current and set dwell times. No further calculations are required after the first run through a list. The current dwell times will definitely no longer deviate from the set dwell times.

The list is either processed from the beginning to the end of the list (modes **Auto**, (**External**) **Single**, (**External**) **Step**) or by hopping from one freely selectable list index (frequency/level pair) to the next (modes **Fast Hop**, **Fast Hop Direct**).

The Fast Hop control signals (clock, strobe and data) are supplied via the serial FHOP bus on the **Digital I/O** interface at the rear of the instrument. Data transmission starts with the MSB (most significant bit). A strobe marks the LSB (least significant bit) and thus the end of a valid data sequence (40 bits). The data bits determine the RF path, the Fast Hop mode (direct or not) and the processed list index.

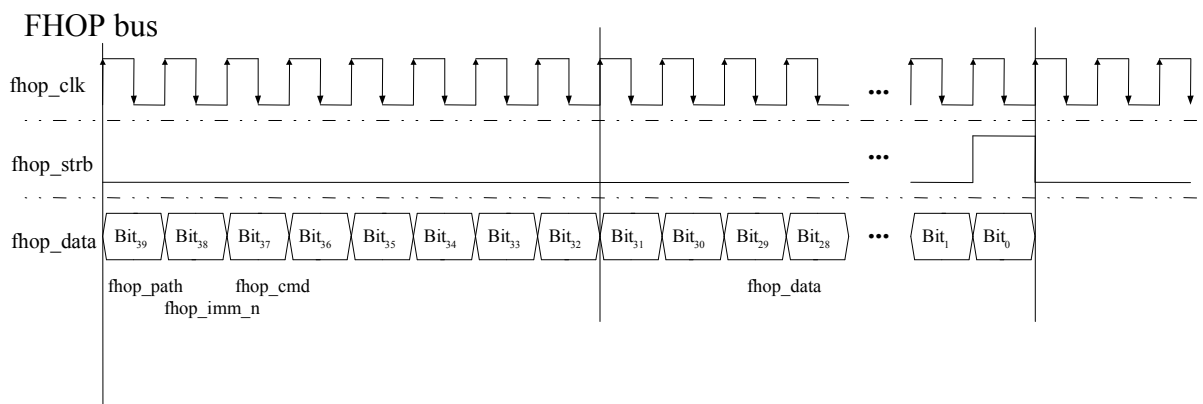

Fig. 4-1 Input control signals for List Modes Fast Hop and Fast Hop Direct on the serial FHOP bus of the Digital I/O interface

Table 4-1 Function of data bits of FHOP bus (fhop\_data line, see following figure) and their function for controlling fast frequency hopping

Data bit name (bit number)	Function
path (39)	Selects RF path: 0 = RF path A; 1 = RF path B
imm_n (38)	Selects Fast Hop mode: 0 = Fast Hop Direct (the selected settings are performed at once after data transfer of a complete sequence (40 bits) without additional triggering) 1 = Fast Hop (the selected settings are performed after an instrument trigger)
cmd (37 to 32)	Selects function for fast hop mode. Bit 32 must be set to 1 (= List Mode) Bit 37 to 33 must be set to 0 (= reserved for future extensions)
data (31 to 0)	Data bits Determine the list index (frequency/level setting) to be processed for List Mode

**Example:**

The bit sequence 0100-0010-0000-0000-0000-0000-0000-0000-1010 on data line **fhop\_data** selects the list index 10 of the currently loaded list on path A. The frequency and level setting associated with this index are performed after the next instrument trigger.

**Preconditions:**

List Mode **Fast Hop** is selected in the LIST menu and a list with at least 10 entries is loaded. An external trigger is provided on pin **INST TRIG A** of interface Digital I/O.



The **List Mode** menu is opened either in the **RF/Ana Mod** function block or using the **MENU** key (CTRL+M) under **RF/Ana Mod**.



The menu is used to activate/deactivate operating mode List, to create, select and activate the lists, and to select the trigger mode and the dwell time.

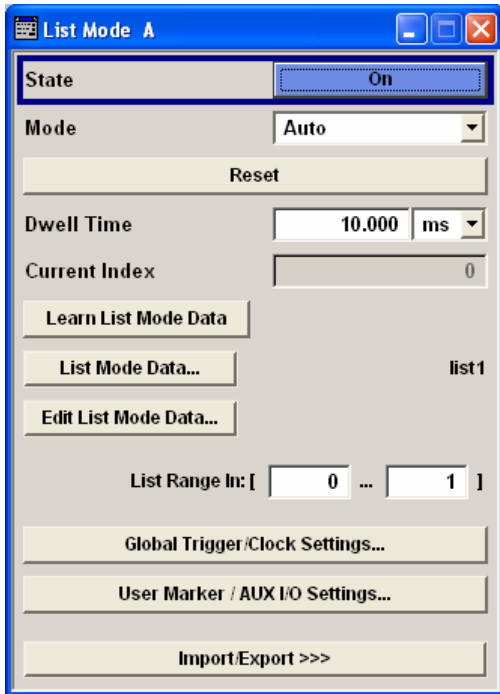

**State - List Mode**

Activates/deactivates the List mode. The currently selected list is processed.

In case of a new or modified list, the necessary hardware settings are automatically determined on activation of the list mode. The data determined in this way is stored along with the list and is available whenever the list is used again.

This means that when activating the list mode, the system checks whether any hardware settings are present. If so, the list is started immediately, but if not they are automatically determined (the list is learnt).

A **Learn List Mode Data** button is available for deliberately activating list learning.

**Note:**

*Activating the list mode automatically deactivates all sweeps.*

Remote-control command:

SOUR:FREQ:MODE LIST

**Attenuator Mode – List Mode with High Power Option**

Sets the ranges of level settings for the list mode. The level settings are either performed in the low level or in the high level ranges.

Parameter **Attenuator Mode** is only available when the instrument is equipped with the high-power output option (R&S SMATE-B31 or R&S SMATE-B36).

**Note:**

*An error message is generated and the best possible level is set if the list contains level values outside the selected range.*

**Normal**

The level settings are made in the area of the electronically switching attenuator. The high level ranges are not available.

Remote-control command:

:LIST:POW:AMOD NORM

**High Power**

The level settings are made in the area of the option. Only the high level range is available.

Remote-control command:

:LIST:POW:AMOD HPOW

**Mode - List Mode**

Selects the cycle mode of the List mode.

**Auto**

Cycle from the beginning to the end of the list with automatic restart at the beginning. If a different mode was activated prior to the **Auto** mode, the cycle continues from the current index. The duration of a list step is determined by the set dwell time.

Remote-control command:

```
SOUR:FREQ:MODE LIST
SOUR:LIST:MODE AUTO
SOUR:LIST:TRIG:SOUR AUTO
```

**Single**

Single cycle from the beginning to the end of the list. If **Single** is selected, the cycle is not started immediately. The **Execute Single** button appears under the **Mode** line. The cycle is started with this button. The duration of a list step is determined by the set dwell time.



Remote-control command:

```
SOUR:FREQ:MODE LIST
SOUR:LIST:MODE AUTO
SOUR:LIST:TRIG:SOUR SING
SOUR:LIST:TRIG:EXEC
```

**Step**

Manual, step-by-step processing of the list. Activating **Step** stops the current list and the cursor moves to the value displayed for **Current Index**. It is now possible to scroll up and down in the list in discrete steps by varying the index. The duration of a list step is determined by the time between two index entries.



Remote-control command:

```
SOUR:FREQ:MODE LIST
SOUR:LIST:MODE STEP
SOUR:LIST:TRIG:SOUR SING
```

**Extern Single**

Single cycle from the beginning to the end of the list as with **Single**, but started by an external trigger.

The external trigger signal is input at the rear of the instrument. The BNC connector INST TRIG is provided for Path A, and the pin INST TRIG B on the AUX I/O interface for Path B.

Remote-control command:

```
SOUR:FREQ:MODE LIST
SOUR:LIST:MODE AUTO
SOUR:LIST:TRIG:SOUR EXT
```

**Extern Step**

Step-by-step cycle using the external trigger signal. Each trigger event starts a single step. The duration of a list step is determined by the time between two trigger events.

The external trigger signal is input at the rear of the instrument. The BNC connector INST TRIG is provided for Path A, and the pin INST TRIG B on the AUX I/O interface for Path B.

Remote-control command:

```
SOUR:FREQ:MODE LIST
SOUR:LIST:MODE STEP
SOUR:LIST:TRIG:SOUR EXT
```

**Fast Hop**

Index-by-index cycle. The processed list index is determined by the external control signals provided via the serial FHOP bus on the Digital I/O interface at the rear of the instrument (see above, introduction to list mode).

The external trigger signal is used. Each trigger event starts the processing of the frequency and level settings associated with selected index (trigger source as described under **Extern Single**). The duration of a list step is determined by the time between two trigger events. Note that the `fhop_imm_n` bit has to be disabled on the `fhop_data` line (= 1, see above, introduction to list mode).

Remote-control command:

```
SOUR:FREQ:MODE LIST
SOUR:LIST:MODE HOP
SOUR:LIST:TRIG:SOUR EXT
```

**Fast Hop Direct**

Index-by-index cycle. The processed list index is determined by the external control signals provided via the serial FHOP bus on the Digital I/O interface at the rear of the instrument.

Processing of the frequency and level settings associated with selected index is automatically started at the end of data transmission. Note that the `fhop_imm_n` bit has to be enabled on the `fhop_data` line (= 0, see above, introduction to list mode).

Remote-control command:

```
SOUR:FREQ:MODE LIST
SOUR:LIST:MODE DHOP
SOUR:LIST:TRIG:SOUR EXT
```

**Execute Single - List Mode** Triggers the list manually. This button is available only if **Mode Single** is selected.

Remote-control commands

```
SOUR:FREQ:MODE LIST
```

```
SOUR:LIST:MODE AUTO
```

```
SOUR:LIST:TRIG:SOUR SING
```

```
SOUR:LIST:TRIG:EXEC
```

**Reset - List Mode** Resets the list to the starting point.

Remote-control command:

```
SOUR:LIST:RES
```

**Dwell Time - List Mode** Enters the dwell time. The dwell time determines the duration of a list step in list operating modes **Auto**, **Single** and **Extern Single**. In these modes a complete list is processed either once or continuously.

In list operating modes **Step** and **Extern Step**, the set dwell time does not affect signal generation. In this case, the duration of a list step is determined by the time between two (internal or external) trigger events.

Remote-control command:

```
SOUR:LIST:DWEL 10 ms
```

**Current Index - List Mode** Sets the list index in **Step** mode.

Remote-control command: n.a.

**Learn List Mode Data... - List Mode**

Starts the determination of the hardware setting for the selected list. The data determined in this way is stored along with the list.

It may be necessary to deliberately activate list learning in the event of greatly altered environmental conditions that require new hardware settings.

If this is not done, a previously learned hardware setting will continue to be used when list mode is switched on (**State = On**). If no setting is available, e.g. when the list is used for the first time, learning is automatically activated.

Remote-control command:

```
SOUR:LIST:LEAR
```

**List Mode Data... - List Mode**

Calls the **File Select** menu for selecting and creating a list or the **File Manager**.



Remote-control command:

SOUR:LIST:CAT?

Response: 'MYLIST', 'LIST1', 'LIST2'

SOUR:LIST:SEL 'LIST2'

SOUR:LIST:DEL 'LIST1'

SOUR:LIST:DEL:ALL

**Edit List Mode Data... - List Mode**

Calls the editor for editing the selected list. A list consists of any number of frequency/level value pairs. The currently selected list is displayed.

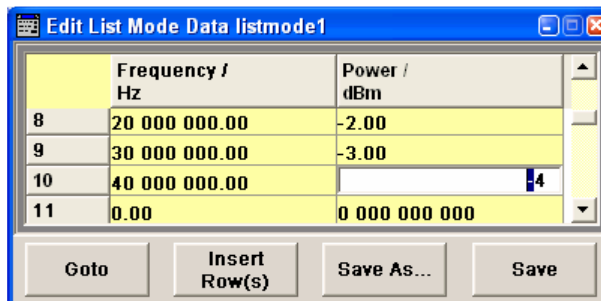

**Frequency /Hz**

Enter the frequency of the frequency/power value pair.

Remote-control command:

SOUR:LIST:FREQ 1.4GHz,1.3GHz,1GHz...

**Power /dBm**

Enter the level of the frequency/power value pair.

Remote-control command:

SOUR:LIST:POW 0dBm, 2dBm, 2dBm, 3dBm, ...

**Goto**

Selects row for editing.



If Goto row is selected, a window opens for entering the requested row.

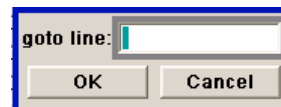

Remote-control command: n.a.

(it is not possible to change individual positions of the list)

**Insert/Fill**

Opens the Insert/Fill Row selection box.

**Row(s)**



**Insert row**

Inserts a new row before the marked row.

**Insert range**

Inserts a new row before the marked row

**Fill...**

Opens the Fill Table menu (see below).

Remote-control command: n.a.

**Save as**

Open the file menu to save the list under a new name.

Each list is saved to the R&S Vector Signal Generator hard disk as a separate file with the file prefix **\*.lsw**. The file name and the directory to which the file is saved are user-selectable.

Remote-control command: -

**Save**

The list is saved under its current name.

Remote-control command: -

(the list is saved automatically after the values have been entered)

**Fill Table - List Mode**

The **Fill Table** menu is opened in the list editor using button **Insert/Fill Row** with selection **Fill...**

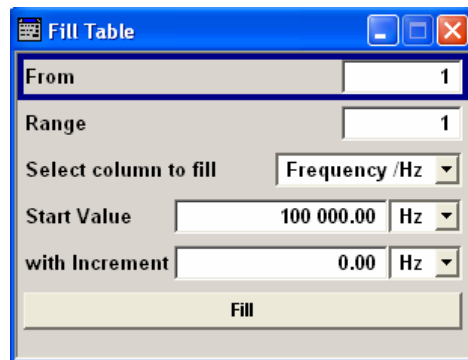

The List Mode table can be used to automatically fill the List Mode table with the selected values for the defined index range.

The list entries are only computed when the **Fill** button is pressed.

**From** Sets the start value of the index range.

Remote-control command: na

**Range** Sets the range for filling the table .

Remote-control command: na

- Select column to fill** Selects either the frequency or the level column to be filled with the value defined below.  
Remote-control command: n.a
- Start value** Sets the start value for the frequency or the level entries.  
Remote-control command: na
- With increment** Sets the increment for the frequency or the level entries.  
Remote-control command: na
- Fills** Fills the selected column in the set range with values, starting with the start value and using the set increment.  
Remote-control command: na

**List Range In - List Mode**

Defines an index range in the current list by setting the start and stop index. Only the values in the selected index range are processed in List mode, all other list entries are ignored.

Remote-control command:  
 SOUR:LIST:IND:STAR 15  
 SOUR:LIST:IND:STOP 155

**Global Trigger/Clock Settings - List Mode**

Open the **Global Trigger/Clock Settings** menu. This menu is used among other things for setting the polarity of the active slope of an applied instrument trigger

In the case of two-path instruments this setting is valid for both paths. It affects the INST TRIG input (BNC connector at the rear of the instrument, instrument trigger for Path A) and the INST TRIG B input of the AUX I/O interface at the rear of the instrument, instrument trigger for Path B).

See also section "[Global Trigger/Clock/External Input Settings - Setup-Environment](#)", on page 4.13.



**User Marker AUX I/O Settings - List Mode**

Calls the menu for configuring the AUX I/O and user interfaces (see the following section "[User Marker - AUX IO - Setup-Environment-Global...Settings](#)").

The pin assignment of the AUX I/O interface is shown in the **User Marker - AUX I/O Configuration** menu; the assignment of the USER pins 2...4 and USER 1 BNC connector can be changed.

With two-path instruments, the current assignment to the respective path is given in addition to the pin assignment.

User correction list can be imported from externally created files or exported into text or CSV-files. The import/export settings are available after clicking the **Import/Export** button.

**Import/Export - List Mode**

Expands the menu with the area for import and export of list mode files.



Externally edited Excel tables with frequency/level pairs can be imported as text or CSV-files and used for list mode.

On the other hand, internally created list mode list can be exported as text or CSV-files..

**Mode - List Mode**

Selects if list mode lists should be imported or exported. The settings offered below depend on the selected mode.

Remote-control command:  
`SOUR:LIST:DEXC:MODE IMP`

**Extension - List Mode**

Selects the file extension of the ASCII file to be imported or exported. Selection TXT (text file) or CSV (Excel file) is available.

Remote-control command:  
`SOUR:LIST:DEXC:AFIL:EXT TXT`

**Decimal Point - List Mode**      Selects the decimal separator used in the ASCII data between '.' (decimal point) and ',' (comma) with floating-point numerals.

Remote-control command:  
SOUR:LIST:DEXC:AFIL:SEP:DEC DOT

**Column Separator- List Mode**      Selects the separator between the frequency and level column of the ASCII table.

Remote-control command:  
SOUR:LIST:DEXC:AFIL:SEP:COL TAB

**Select ASCII Source / Destination - List Mode**      Calls the **File Manager** for selecting the ASCII file to be imported into a list mode list (source) or the ASCII file the list mode list is exported (destination) in.

Remote-control command:  
SOUR:LIST:DEXC:AFIL:SEL "var/user/list/list1.txt"

**Destination / Source - List Mode**      Calls the **File Manager** for selecting the list mode list to be exported (source) into an ASCII file or the destination for the ASCII file to be imported (destination) in.

Remote-control command:  
SOUR:LIST:DEXC:SEL "var/user/ucor/list1.txt"

**Import / Export - List Mode**      Starts the export or import of the selected file.  
When import is selected, the ASCII file is imported as list mode list.  
When export is selected, the list mode list is exported into the selected ASCII file.

Remote-control command:  
SOUR:LIST:DEXC:EXEC

## Sweep Mode

The R&S Vector Signal Generator offers three different sweep types (frequency sweep, level sweep and LF sweep) to be activated alternatively. Each type has 5 modes which differ with respect to the sweep cycle mode (continuous, individual and step-by-step) and triggering mode (automatic, internal and external).

A sweep is set in five basic steps which are shown below taking a frequency sweep as an example:

1. Set the sweep range (**Start Freq** and **Stop Freq** or **Center Freq** and **Span**).
2. Select linear or logarithmic sweep spacing (**Spacing**).
3. Set the step width (**Step Lin/Log**) and dwell time (**Dwell Time**).
4. Activate the sweep (**Mode** to **Auto**, **Single**, **Step** or **Extern Single**, **Extern Step**).
5. Trigger the sweep, except for Auto mode (Execute Single Sweep, Current Frequency or External Trigger Signal).

---

### Note:

*Sweeps and List mode can not be activated simultaneously, they deactivate each other.*

---

## Frequency Sweep Menu

The **Frequency Sweep** menu is opened either in the **RF/A Mod** function block or in the menu tree of the **[MENU]** key under **RF Signal**.



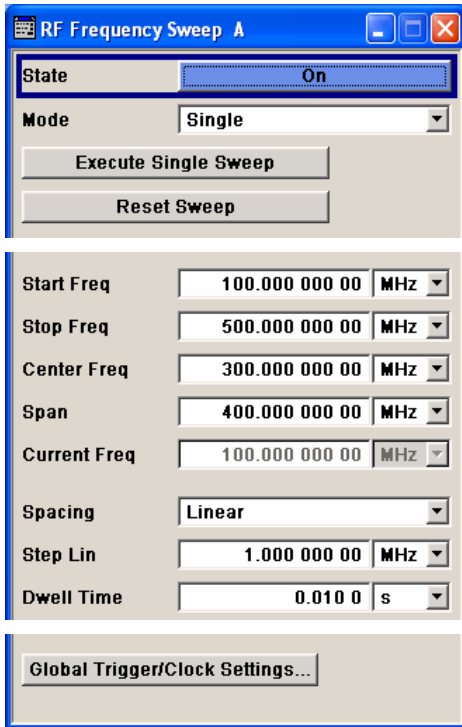

In the top section of the menu, the RF sweep mode is activated and the sweep mode is selected.

The buttons are used to reset the RF sweep (all sweep modes) or to execute the RF sweep (**Single** mode).

The sweep range, sweep spacing and dwell time are set in the bottom section.

The sweep range of the RF sweep can be entered in two ways, either by entering the **Start** and **Stop** value or by entering the **Center** and **Span**. The two sets of parameters influence each other in the following way:

**Start** = (Center - Span/2)

**Stop** = (Center + Span/2)

**Center** = (Start + Stop)/2

**Span** = (Stop - Start)

In the top section of the menu, the RF sweep mode is activated and the sweep mode is selected. The buttons are used to reset the RF sweep (all sweep modes) or to execute the RF sweep (**Single** mode).

**State - Frequency Sweep** Activates/deactivates RF sweep mode.

**Note:**

*Activating the RF frequency sweep automatically deactivates the list mode. All sweep types (RF sweep, level sweep and LF sweep) can be activated simultaneously.*

Remote-control commands:

```
SOUR:FREQ:MODE SWE
SOUR:FREQ:MODE CW
```

**Mode - Frequency Sweep** Selects the Sweep instrument operating mode and the Sweep mode.

**Auto**

Sets an automatic repeated sweep cycle. If a different sweep mode was activated prior to the **Auto** mode, the cycle continues from the current sweep setting.

Remote-control commands:

```
SOUR:SWE:FREQ:MODE AUTO
TRIG:FSW:SOUR AUTO
SOUR:FREQ:MODE SWE
```

<b>Single</b>	<p>Sets a single sweep cycle. The sweep is triggered by the <b>Execute Single Sweep</b> button.</p> <p>If a different sweep mode was activated prior to the <b>Single</b> mode, the current sweep is stopped. The <b>Single</b> sweep always starts at the start frequency when triggered.</p> <p>Remote-control commands: SOUR:SWE:FREQ:MODE AUTO TRIG:FSW:SOUR AUTO SOUR:FREQ:MODE SWE SOUR:SWE:FREQ:EXEC</p>
<b>Step</b>	<p>Sets a step-by-step sweep cycle.</p> <p>If this mode is activated, the cursor moves to the value displayed for <b>Current Freq</b>. Any variation to the <b>Current Freq</b> value triggers a sweep step.</p> <p>If a different sweep mode was activated prior to the <b>Step</b> mode, the current sweep is stopped. The <b>Step</b> sweep starts at the current RF frequency when triggered.</p> <p>Remote-control commands: SOUR:SWE:FREQ:MODE MAN SOUR:FREQ:MAN 200 MHz SOUR:FREQ:MODE SWE SOUR:FREQ:MAN 300 MHz SOUR:FREQ:MAN 400 MHz</p>
<b>Extern Single</b>	<p>Sets a single sweep cycle. The sweep is triggered by an external trigger signal.</p> <p>If a different sweep mode was activated prior to the <b>Extern Single</b> mode, the current sweep is stopped. The <b>Extern Single</b> sweep always starts at the start frequency when triggered.</p> <p>The external trigger signal is input at the rear of the instrument. The BNC connector INST TRIG is provided for Path A, and the pin INST TRIG B on the AUX I/O interface for Path B.</p> <p>Remote-control command: SOUR:SWE:FREQ:MODE AUTO TRIG:FSW:SOUR EXT SOUR:FREQ:MODE SWE</p>

**Extern Step** Sets a step-by-step sweep cycle. Each sweep step is triggered by an external trigger signal (trigger source as described under **Extern Single**).

If a different sweep mode was activated prior to the **Extern Step** mode, the current sweep is stopped. The **Extern Step** sweep always starts at the start frequency when triggered.

Remote-control command:  
 SOUR:SWE:FREQ:MODE STEP  
 SOUR:SWE:FREQ:SPAC LIN  
 SOUR:SWE:FREQ:STEP:LIN 1 MHz  
 TRIG:FSW:SOUR EXT  
 SOUR:FREQ:MODE SWE

The sweep range, sweep spacing and dwell time are set in the bottom section.

**Execute Single Sweep - Frequency Sweep** Triggers the sweep manually. A manual sweep can only be triggered if **Mode Single** is selected.

Remote-control commands  
 SOUR:SWE:FREQ:MODE AUTO  
 TRIG:FSW:SOUR SING  
 SOUR:FREQ:MODE SWE  
 SOUR:SWE:FREQ:EXEC

**Reset Sweep - Frequency Sweep** Resets the sweep. The start frequency is set and the next sweep starts from there.

Remote-control command:  
 SWE:RES:ALL

**Start Freq - Frequency Sweep** Sets the start frequency.

Remote-control command:  
 SOUR:FREQ:STAR 100MHz

**Stop Freq - Frequency Sweep** Sets the stop frequency.

Remote-control command:  
 SOUR:FREQ:STOP 500MHz

**Center Freq - Frequency Sweep** Sets the center frequency.

Remote-control command:  
 SOUR:FREQ:CENT 300MHz

<b>Span - Frequency Sweep</b>	<p>Sets the span.</p> <p>Remote-control command: SOUR:FREQ:SPAN 400MHz</p>
<b>Current Freq - Frequency Sweep</b>	<p>Displays the current frequency.</p> <p>If <b>Step</b> is set, the frequency for the next frequency step of the sweep is entered here.</p> <p>Remote-control command SOUR:FREQ:MAN 300MHz</p>
<b>Spacing - Frequency Sweep</b>	<p>Selects linear or logarithmic sweep spacing.</p> <p>Remote-control command: SOUR:SWE:FREQ:SPAC LIN   LOG</p>
<b>Step Lin/Log - Frequency Sweep</b>	<p>Sets the step width for the individual sweep steps. This entry is effective for all sweep modes.</p> <p><b>Step Lin</b> or <b>Step Log</b> is displayed depending on whether <b>Spacing Lin</b> or <b>Log</b> is selected.</p>
	<p><b>Step Lin</b>      With the linear sweep, the step width is a fixed frequency value which is added to the current frequency. The linear step width is entered in Hz.</p> <p>Remote-control command: SOUR:SWE:FREQ:STEP:LIN 1 MHz</p>
	<p><b>Step Log</b>      With the logarithmic sweep, the step width is a constant fraction of the current frequency. This fraction is added to the current frequency. The logarithmic step width is entered in %.</p> <p>Remote-control command: SOUR:SWE:FREQ:STEP:LOG 1 PCT</p>

**Dwell Time - Frequency Sweep**

Sets the dwell time. The dwell time determines the duration of the individual sweep steps

Remote-control command:

SOUR:SWE:FREQ:DWEL 10ms

**Global Trigger/Clock Settings - Frequency Sweep**

Calls the **Global Trigger/Clock Settings** menu. This menu is used among other things for setting the polarity of the active slope of an applied instrument trigger

In the case of two-path instruments this setting is valid for both paths. It affects the INST TRIG input (BNC connector at the rear of the instrument, instrument trigger for Path A) and the INST TRIG B input of the AUX I/O interface at the rear of the instrument, instrument trigger for Path B).

See also section "[Global Trigger/Clock/External Input Settings - Setup-Environment](#)", on page 4.13.



## Level Sweep Menu

The **Level Sweep** menu is opened either in the **RF/A Mod** function block or using the **[MENU]** key under **RF/A Mod**.

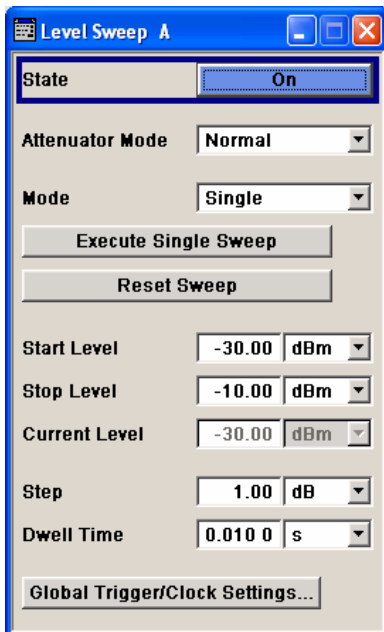
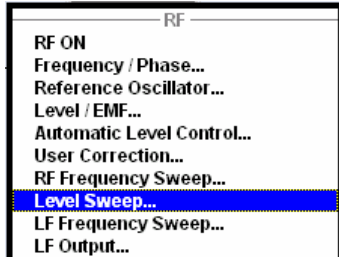

In the top section, the Level Sweep mode is activated and the sweep mode is selected. The buttons are used to reset the level sweep (all sweep modes) or to execute the level sweep (**Single** mode).

The level range for the sweeps is selected for instruments with Option High Power.

The sweep range, sweep spacing and dwell time are set in the bottom section.

In the top section, the Level Sweep mode is activated and the sweep mode is selected. The buttons are used to reset the level sweep (all sweep modes) or to execute the level sweep (**Single** mode).

**State - Level Sweep**

Activates Level Sweep mode.

**Note:**

*Activating the level sweep automatically deactivates the list mode. All sweep types (RF sweep, level sweep and LF sweep) can be activated simultaneously.*

Remote-control commands:

SOUR:POW:MODE SWE

SOUR:POW:MODE CW

**Attenuator Mode – Level Sweep with High Power Option**

(High Power Option only) Sets the ranges of level settings for the level sweep. The sweep is either performed in the low level or in the high level ranges.

Parameter **Attenuator Mode** is only available when the instrument is equipped with the high-power output option (R&S SMATE-B31 or R&S SMATE-B36).

**Note:**

*An error message is generated and the best possible level is set if the level setting for the current sweep step is outside the selected range.*

**Normal**

The level settings for the level sweep are made in the area of the electronically switching attenuator. The high level ranges are not available.

Remote-control command:

:SWE:POW:AMOD NORM

**High Power**

The level settings for the level sweep are made in the area of the option. Only the high level range is available.

Remote-control command:

:SWE:POW:AMOD HPOW

**Mode - Level Sweep**

Selects the Level Sweep instrument operating mode and the Sweep mode.

**Auto**

Sets an automatic repeated sweep cycle. If a different sweep mode was activated prior to the **Auto** mode, the cycle continues from the current sweep setting.

Remote-control commands:

SOUR:SWE:POW:MODE AUTO

TRIG:PSW:SOUR AUTO

SOUR:POW:MODE SWE

- Single** Sets a single sweep cycle. The sweep is triggered by the **Execute Single Sweep** button.
- If a different sweep mode was activated prior to the **Single** mode, the current sweep is stopped. The **Single** sweep always starts at the start level.
- Remote-control commands:  
SOUR:SWE:POW:MODE AUTO  
TRIG:PSW:SOUR SING  
SOUR:POW:MODE SWE  
SOUR:SWE:POW:EXEC
- Step** Sets a step-by-step sweep cycle. Each sweep step is triggered by a variation of the value in the **Current Level** entry window.
- If this mode is activated, the cursor moves to the value displayed for **Current Level**. If a different sweep mode was activated prior to the **Step** mode, the current sweep is stopped. The **Step** sweep starts at the current level value.
- Remote-control commands:  
SOUR:SWE:POW:MODE STEP  
TRIG:PSW:SOUR SING  
SOUR:POW:MAN -16  
TRIG:PSW:SOUR SING  
SOUR:POW:MODE SWE  
SOUR:POW:MAN -16.5  
SOUR:POW:MAN -17
- Extern Single** Sets a single sweep cycle. The sweep is triggered by an external trigger signal.
- If a different sweep mode was activated prior to the **Extern Single** mode, the current sweep is stopped. The **Extern Single** sweep always starts at the start level.
- The external trigger signal is input at the rear of the instrument. The BNC connector INST TRIG is provided for Path A, and the pin INST TRIG B on the AUX I/O interface for Path B.
- Remote-control command:  
SOUR:SWE:POW:MODE AUTO  
TRIG:PSW:SOUR EXT  
SOUR:POW:MODE SWE  
(External trigger)

**Extern Step** Sets a step-by-step sweep cycle. Each sweep step is triggered by an external trigger signal (trigger source as described under **Extern Single**). The step width corresponds to the step width of the rotary knob.

If a different sweep mode was activated prior to the **Extern Step** mode, the current sweep is stopped. The **Extern Step** sweep always starts at the start level.

Remote-control command:  
 SOUR:SWE:POW:MODE STEP  
 SOUR:SWE:POW:STEP 0.5  
 TRIG:PSW:SOUR EXT  
 SOUR:POW:MODE SWE  
 (External trigger)

**Reset Sweep - Level Sweep** Resets the sweep. The start level is set and the next sweep starts from there.

Remote-control command:  
 SWE:RES:ALL

**Execute Single Sweep - Level Sweep** Triggers the sweep manually. A manual sweep can only be triggered if **Mode Single** is selected.

Remote-control commands  
 SOUR:SWE:POW:MODE AUTO  
 TRIG:PSW:SOUR SING  
 SOUR:POW:MODE SWE  
 SOUR:SWE:POW:EXEC

The sweep range, sweep spacing and dwell time are set in the bottom section.

**Start Level - Level Sweep** Sets the start level.

Remote-control command:  
 SOUR:POW:STAR -100

**Stop Level - Level Sweep** Sets the stop level.

Remote-control command:  
 SOUR:POW:STOP -10

**Current Level - Level Sweep**

Displays the current level.

If **Step** is set, the level for the next level step of the sweep is entered here.

Remote-control command

```
SOUR:POW:MAN -30
```

**Step - Level Sweep**

Sets the step width for the individual sweep steps. This entry is effective for all sweep modes.

With the level sweep, the logarithmic step width is a constant fraction of the current level. This fraction is added to the current level. The logarithmic step width is entered in dB.

Remote-control command:

```
SOUR:SWE:POW:STEP 3
```

**Dwell Time - Level Sweep**

The enter the dwell time. The dwell time determines the duration of the individual sweep steps.

Remote-control command:

```
SOUR:SWE:POW:DWEL 10ms
```

**Global Trigger/Clock Settings - level Sweep**

Open the **Global Trigger/Clock Settings** menu. This menu is used among other things for setting the polarity of the active slope of an applied instrument trigger

In the case of two-path instruments this setting is valid for both paths. It affects the INST TRIG input (BNC connector at the rear of the instrument, instrument trigger for Path A) and the INST TRIG B input of the AUX I/O interface at the rear of the instrument, instrument trigger for Path B).

See also section "[Global Trigger/Clock/External Input Settings - Setup-Environment](#)", on page 4.13.

## LF Frequency Sweep Menu

The **LF Frequency Sweep** menu is opened either in the **RF/A Mod** function block or using the **[MENU]** key (CTRL+M) under **RF/A Mod**.

With two-path instruments, the frequency settings are always effective for both paths since an LF generator is available for both paths in the instrument.

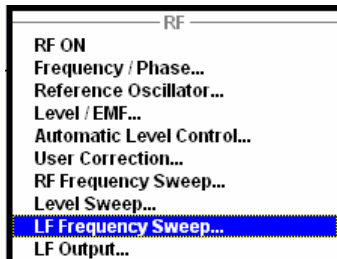

The top sections of the combined menu LF Output / LF Frequency Sweep provide access to the LF Sweep mode settings. The lower section provides access to the LF output settings, see section "[LF Generator and LF Output - LF Output](#)", page 4.94.

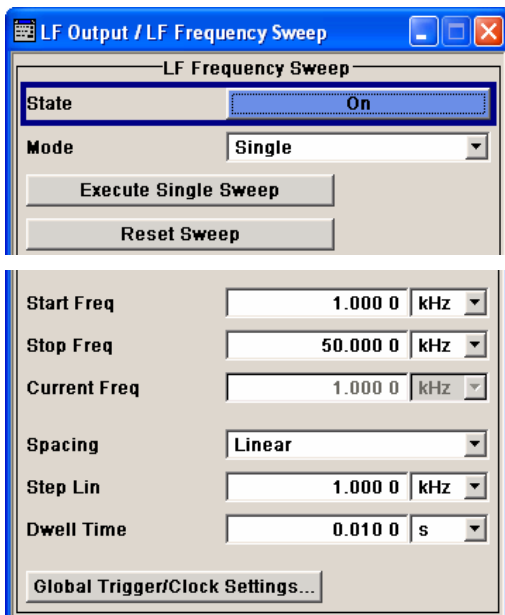

In the top section, the LF Sweep mode is activated and the sweep mode is selected. The buttons are used to reset the LF sweep (all sweep modes) or to execute the LF sweep (**Single** mode).

The sweep range, sweep spacing and dwell time are set in the bottom section.

In the top section, the LF Sweep mode is activated and the sweep mode is selected. The buttons are used to reset the LF sweep (all sweep modes) or to execute the LF sweep (**Single** mode).

**State - LF Sweep**

Activates LF Sweep mode.

**Note:**

*Activating the LF sweep automatically deactivates the list mode. All sweep types (RF sweep, level sweep and LF sweep) can be activated simultaneously.*

## Remote-control commands:

```
SOUR:LFO:FREQ:MODE SWE
```

```
SOUR:LFO:FREQ:MODE CW
```

**Mode - LF Sweep**

Selects the Sweep instrument operating mode and Sweep mode.

**Auto**

Sets an automatic repeated sweep cycle. If a different sweep mode was activated prior to the **Auto** mode, the cycle continues from the current sweep setting.

## Remote-control commands:

```
SOUR:LFO:SWE:FREQ:MODE AUTO
```

```
TRIG0:SWE:SOUR AUTO
```

```
SOUR:LFO:FREQ:MODE SWE
```

**Single**

Sets a single sweep cycle. The sweep is triggered by the **Execute Single Sweep** button.

If a different sweep mode was activated prior to the **Single** mode, the current sweep is stopped. The **Single** sweep always starts at the start frequency.

## Remote-control commands:

```
SOUR:LFO:SWE:FREQ:MODE AUTO
```

```
TRIG0:SWE:SOUR SING
```

```
SOUR:LFO:FREQ:MODE SWE
```

```
SOUR:LFO:SWE:FREQ:EXEC
```

**Step**

Sets a step-by-step sweep cycle. Each sweep step is triggered by a variation of the value in the **Current Freq** entry window.

If this mode is activated, the cursor moves to the value displayed for **Current Freq**. If a different sweep mode was activated prior to the **Step** mode, the current sweep is stopped. The **Step** sweep starts at the current LF frequency.

## Remote-control command:

```
SOUR:LFO:SWE:FREQ:MODE MAN
```

```
SOUR:LFO:FREQ:MAN 12 kHz
```

```
SOUR:LFO:FREQ:MODE SWE
```

```
SOUR:LFO:FREQ:MAN 14 kHz
```

```
SOUR:LFO:FREQ:MAN 16 kHz
```

- Extern Single** Sets a single sweep cycle. The sweep is triggered by an external trigger signal.
- If a different sweep mode was activated prior to the **Extern Single** mode, the current sweep is stopped. The **Extern Single** sweep always starts at the start frequency.
- The external trigger signal is input at the rear of the instrument. The BNC connector INST TRIG is provided for Path A, and the pin INST TRIG B on the AUX I/O interface for Path B.
- Remote-control command:  
 SOUR:LFO:SWE:FREQ:MODE AUTO  
 TRIG0:SWE:SOUR EXT  
 SOUR:LFO:FREQ:MODE SWE  
 (External trigger)
- Extern Step** Sets a step-by-step sweep cycle. Each sweep step is triggered by an external trigger signal (trigger source as described under **Extern Single**). The step width corresponds to the step width set for the rotary knob.
- If a different sweep mode was activated prior to the **Extern Step** mode, the current sweep is stopped. The **Extern Step** sweep always starts at the LF start frequency.
- Remote-control command:  
 SOUR:LFO:SWE:FREQ:MODE STEP  
 TRIG0:SWE:SOUR EXT  
 SOUR:LFO:FREQ:MODE SWE  
 (External trigger)
- Reset Sweep - LF Sweep** Resets the sweep. The start frequency is set and the next sweep starts from there.
- Remote-control command:  
 SWE:RES:ALL
- Execute Single Sweep - LF Sweep** Triggers the sweep manually. A manual sweep can only be triggered if **Mode Single** is selected.
- Remote-control commands  
 SOUR:LFO:SWE:FREQ:MODE AUTO  
 TRIG0:SWE:SOUR SING  
 SOUR:LFO:FREQ:MODE SWE  
 SOUR:LFO:SWE:FREQ:EXEC



The sweep range, sweep spacing and dwell time are set in the bottom section.

<b>Start Freq - LF Sweep</b>	<p>Sets the start frequency.</p> <p>Remote-control command: SOUR:LFO:FREQ:STAR 100kHz</p>
<b>Stop Freq - LF Sweep</b>	<p>Sets the stop frequency.</p> <p>Remote-control command: SOUR:LFO:FREQ:STOP 50kHz</p>
<b>Current Freq - LF Sweep</b>	<p>Displays the current frequency.</p> <p>If <b>Step</b> is set, the frequency for the next frequency step of the sweep is entered here.</p> <p>Remote-control command SOUR:LFO:FREQ:MAN 15 kHz</p>
<b>Spacing - LF Sweep</b>	<p>Selects linear or logarithmic sweep spacing.</p> <p>Remote-control command: SOUR:LFO:SWE:FREQ:SPAC LIN   LOG</p>
<b>Step Lin/Log - LF Sweep</b>	<p>Sets the step width for the individual sweep steps. This entry is effective for all sweep modes.</p> <p><b>Step Lin</b> or <b>Step Log</b> is displayed depending on whether <b>Spacing Lin</b> or <b>Log</b> is selected.</p> <p><b>Step Lin</b>            With the linear sweep, the step width is a fixed frequency value which is added to the current frequency. The linear step width is entered in Hz.</p> <p>Remote-control command: SOUR:LFO:SWE:FREQ:STEP:LIN 1 kHz</p> <p><b>Step Log</b>            With the logarithmic sweep, the step width is a constant fraction of the current frequency. This fraction is added to the current frequency. The logarithmic step width is entered in %.</p> <p>Remote-control command: SOUR:LFO:SWE:FREQ:STEP:LOG 1 PCT</p>

**Dwell Time - LF Sweep**      Sets the dwell time. The dwell time determines the duration of the individual sweep steps.

Remote-control command:

SOUR:LFO:SWE:FREQ:DWEL 10ms

**Global Trigger/Clock Settings - LF Sweep**

Open the **Global Trigger/Clock Settings** menu. This menu is used among other things for setting the polarity of the active slope of an applied instrument trigger

In the case of two-path instruments this setting is valid for both paths. It affects the INST TRIG input (BNC connector at the rear of the instrument, instrument trigger for Path A) and the INST TRIG B input of the AUX I/O interface at the rear of the instrument, instrument trigger for Path B).

See also section "[Global Trigger/Clock/External Input Settings - Setup-Environment](#)", on page 4.13.

## **LF Generator and LF Output - LF Output**

The internal LF generator is available as the internal source for the analog modulations AM, FM / PM and Pulse, and also as the signal source for the LF output at the rear of the instrument.

The frequency setting for the LF generator can be made both in the modulation menus and in the LF Output menu.

A change to the frequency of the LF generator automatically has an effect on modulation if the LF generator is selected as the modulation source (i.e. **Internal** is selected as **Source**). With two-path instruments, the frequency setting is always effective for both paths since an LF generator is available for both paths in the instrument.

The LF Sweep mode is activated in the **LF Sweep** menu.

## LF Output Menu

The **LF Output** menu is opened either in the **RF/A Mod** function block or using the **MENU** key under **RF/A Mod**.

The combined menu LF Output / LF Frequency Sweep provides access to the LF output configuration in the bottom section. The top sections provide access to the LF Sweep mode settings, see section "[LF Frequency Sweep Menu](#)", page 4.90.

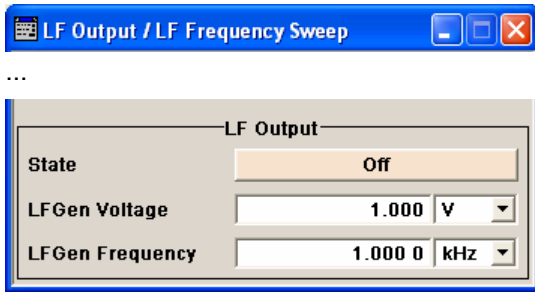

### State - LF Output

Activates/deactivates the LF output. This setting has no effect on the modulations.

Remote-control command:

SOUR:LFO:STAT ON | OFF

### LF Gen Voltage - LF Output

Sets the output voltage of the LF output. The entered value determines the peak voltage.

Remote-control command:

SOUR:LFO:VOLT 1 V

### LF Gen Frequency - LF Output

Sets the frequency of the LF generator. This setting affects all analog modulations which use the LF generator as the internal modulation source.

Remote-control command:

SOUR:LFO:FREQ 1 kHz

## Analog Modulations

The R&S Vector Signal Generator provides the analog modulations amplitude modulation (AM), broadband amplitude modulation (BB-AM) and pulse modulation (Pulse) for the basic unit (R&S SMATE + frequency option R&S SMATE-B10x) without additional equipment options. Two-path instruments require a second RF path (R&S SMATE-B20x option).

The analog modulations frequency modulation (FM) and phase modulation (PhiM) require option R&S SMATE-B22 (FM/PhiM Modulator and Low Phase Noise). Two path instruments require a second RF path (R&S SMATE-B20x option) and a second option R&S SMATE-B22.

---

**Note:**

The **MOD ON/OFF** key switches the modulations on and off. In the two-path mode, the **MOD ON/OFF** key switches all modulations off. Pressing the key again restores the status that was active before the last switch-off. **MOD OFF** is displayed in the info line of the header next to the **Level** field.

Remote-control command:

```
SOUR:MOD:ALL:STAT OFF
```

---

## Modulation Sources

For amplitude, pulse, frequency and phase modulation the internal and external modulation source can be used. For BB-AM only external modulation sources can be used.

### Internal Modulation Sources

The LF generator is available as internal modulation source. The generator supplies sinusoidal signals in the frequency range 0.1 Hz to 1 MHz (see also the section "[LF Generator and LF Output - LF Output](#)", page 4.94). With pulse modulation, the sinusoidal signal from the LF generator is formed internally into a rectangular signal used to actuate the pulse modulator.

With two-path instruments, the frequency settings are always effective for both paths since an LF generator is available for both paths in the instrument.

### External Modulation Sources

The EXT MOD input at the rear of the instrument is provided as the external modulation source for amplitude, pulse, frequency and phase modulation. The external signal for broadband amplitude modulation is fed in via the I-input.

The external modulation signal at the EXT MOD input must have a voltage of  $U_s = 1 \text{ V}$  ( $U_{\text{eff}} = 0.707 \text{ V}$ ) in order to achieve the displayed modulation depth and range. The input voltage should not exceed  $1.1 V_s$ , otherwise modulation distortions might occur. With external pulse modulation, the switching point is max. 2.4 V and the voltage at the input should not exceed 5 V. The maximum modulation frequency is 10 MHz for frequency and phase modulation.

## Simultaneous Operation of Several Modulations or Other Operating Modes

The table shows the modulations and operating modes which can be activated simultaneously (+) or which deactivate each other (-).

	AM	FM	PHiM	Pulse	BB-AM	I/Q	DM	ARB
Amplitude modulation (AM)	/	+	+	+	-	-	-	-
Frequency modulation (FM)	+	/	-	+	+	+	+	+
Phase modulation (PHiM)	+	-	/	+	+	+	+	+
Pulse modulation	+	+	+	/	+	+	+	+
Broadband AM (BB-AM)	-	+	+	+	/	-	-	-
Vector modulation (I/Q)	-	+	+	+	-	/	-	-
Digital modulation (DM)	-	+	+	+	-	-	/	-
ARB	-	+	+	+	-	-	-	/

## Amplitude Modulation - AM

An internal or external source can be selected for amplitude modulation. The LF GEN modulation generator is available as the internal source. The I/Q modulator is used for amplitude modulation.

The EXT MOD input connector for external feed is at the rear of the instrument. The coupling mode of the input (AC or DC) can be selected.

---

### Note:

*It is not possible to use AM simultaneously with broadband AM, I/Q modulation, arbitrary waveform generation, digital modulation and digital standards.*

*The AM modulation depth is limited by the maximum peak envelope power (PEP).*

---

# Amplitude Modulation Menu

The **Amplitude Modulation** menu is opened either in the **RF/A Mod** function block or using the **MENU** key under **RF/A Mod**.

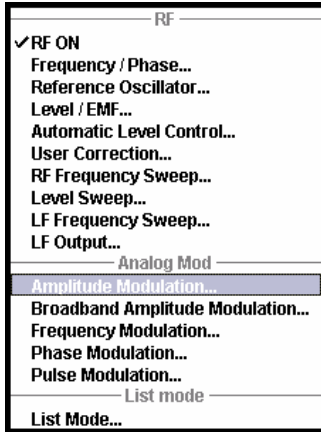

The top section of the combined menu Amplitude Modulation /Broadband AM provides access to the amplitude modulation settings. The lower section provides access to the broadband amplitude modulation settings, see section "[Broadband Amplitude Modulation - BB-AM](#)", page 4.100.

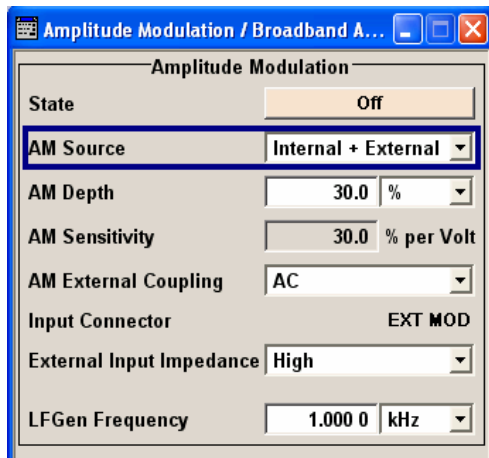

### State - AM

Activates/deactivates AM modulation.

Activation of AM deactivates BB-AM, I/Q modulation, digital modulation and digital standards.

Remote-control command:

```
SOUR:AM:STAT ON
```

<b>AM Source - AM</b>	Selects the source for the AM signal.
	<p><b>Internal</b>      Selects the internal LF generator as the source for AM modulation.</p> <p>Remote-control command: SOUR:AM:SOUR INT</p>
	<p><b>External</b>      Selects the external source. The external signal is input via the EXT MOD connector.</p> <p>Remote-control command: SOUR:AM:SOUR EXT</p>
	<p><b>Intern + Extern</b>      Selects the internal and external source at the same time.</p> <p>Remote-control command: SOUR:AM:SOUR INT,EXT</p>
<b>AM Depth</b>	<p>Sets the modulation depth in percent.</p> <p>Remote-control command: SOUR:AM:DEPT 20PCT</p>
<b>AM Sensitivity</b>	<p>Displays the input sensitivity of the EXT MOD input in %/V. The display only appears in the case of external modulation.</p> <p>The modulation depth entered under <b>AM Depth</b> is reached with 1 volt modulation of the input.</p> <p>Remote-control command: SOUR:AM:SENS? Response: "30"</p>
<b>AM External Coupling</b>	<p>Selects the coupling mode (AC or DC) for external feed.</p> <hr/> <p><b>Note:</b> <i>Coupling for external feed via input EXT MOD can be set independently for modulations AM, FM and PhiM.</i></p> <hr/> <p>Remote-control command: SOUR:AM:EXT:COUP AC</p>

**AM Input Connector**                      Displays the modulation input. The display only appears in the case of external modulation.  
Remote-control command: n.a.

**AM External Input Impedance**                      (Source External only) Selects the impedance for external feed via the EXT MOD input. Selection 50 ohm and high (>100 kohm) is available.  
This setting affects all analog modulations which use the external modulation source.  
Remote-control command:  
SOUR:INP:MOD:IMP G50

**LF Gen Frequency - AM**                      Sets the frequency of the LF generator.  
This setting affects all analog modulations which use the LF generator as the internal modulation source. With two-path instruments, the setting affects both paths.  
Remote-control command:  
SOUR:LFO:FREQ 1E3

## **Broadband Amplitude Modulation - BB-AM**

With broadband amplitude modulation the I/Q modulator is used for amplitude modulation.

Broadband amplitude modulation (BB-AM) is only possible for Path A. An external source is always used. The modulation input is the I-input of the I/Q modulator. The sensitivity for broadband amplitude modulation is 0.25V / 100% modulation depth. It is not possible to set a modulation depth for BB-AM.

---

**Note:**

*It is not possible to use BB-AM simultaneously with AM, I/Q modulation, ARB, digital modulation and digital standards.*

*The upper level limit for BB-AM is the same as that for I/Q modulation. PEP is up to 6 dB above the display value, depending on the modulation depth.*

---



## Broadband Amplitude Modulation Menu

The **Broadband Amplitude Modulation** menu is opened either in the **RF/A Mod** function block or using the **MENU** key under **RF/A Mod**.

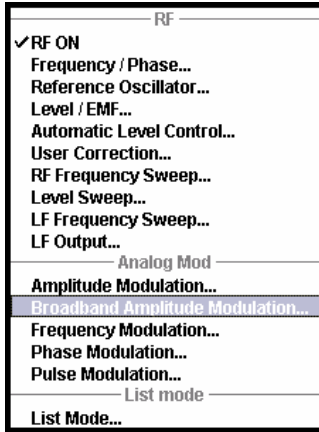

The combined menu Amplitude Modulation /Broadband AM provides access to the Broadband AM configuration in the bottom section. The top section provides access to the amplitude modulation settings, see section "[Amplitude Modulation - AM](#)", page 4.97.

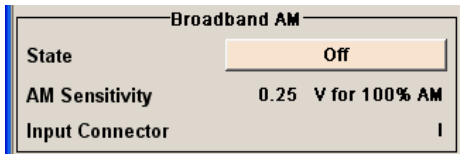

### State - BB-AM

Activates/deactivates broadband AM modulation. Activation of broadband AM deactivates AM, I/Q modulation, digital modulation and digital standards.

Remote-control command:  
 SOUR:AM:BBAN:STAT ON

**AM Sensitivity - BB-AM**

Displays the input sensitivity of the I IN input in V/100% modulation depth. The input sensitivity cannot be influenced in the case of broadband AM since it is not possible to set the range.

Remote-control command:  
 SOUR:AM:BBAN:SENS?  
 Response: "0.25"

**Input Connector - BB-AM**

Displays the modulation input (I-input connector of the I/Q modulator).  
 Remote-control command: n.a.

## Pulse Modulation

Pulse modulation is available for the basic unit (R&S SMATE + frequency option R&S SMATE-B10x) without additional equipment options. An additional frequency option (R&S SMATE-B20x) is required for a two-path instrument.

An internal or external source can be selected for pulse modulation. A simple rectangular signal with selectable repetition frequency is available as the internal signal. This signal is formed from the sinusoidal signal supplied by the LF generator.

The external signal is input via the EXT MOD connector at the rear of the instrument. The polarity of the external pulse modulation can be selected. If **Polarity** is set to **Normal**, the RF level is ON if the level is HIGH at the modulation input.

## Pulse Modulation Menu

The **Pulse Modulation** menu is opened either in the **RF/A Mod** function block or using the MENU key under **RF/A Mod**.

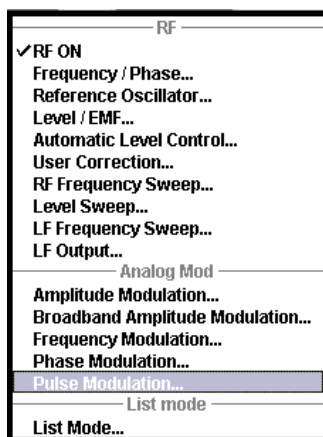

The menu differs according to the selected internal or external modulation source.

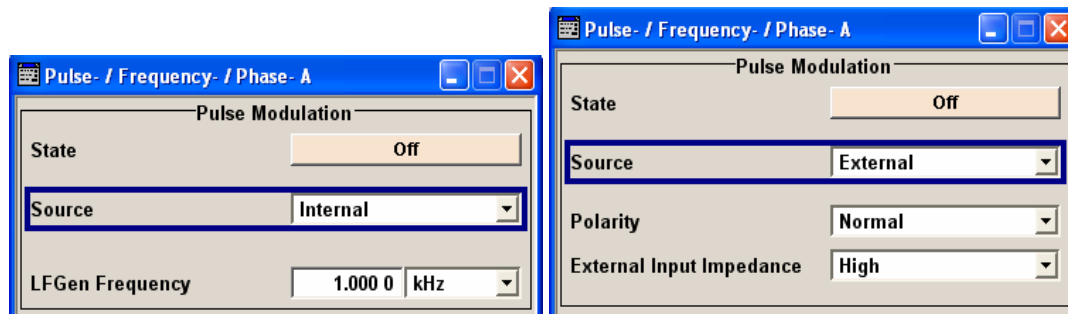

**State - Pulse Modulation** Activates/deactivates pulse modulation. Activation of pulse modulation deactivates ALC and power ramping.

Remote-control command:

SOUR:PULM:STAT ON | OFF

**Source - Pulse Modulation** Selects the source for the pulse modulation signal.

**Internal**

Selects the internal source. The LF generator generates a rectangular pulse with the set frequency.

Remote-control command:

SOUR:PULM:SOUR INT

**External**

Selects the external source. The external modulation signal is input via the EXT MOD connector.

Remote-control command:

SOUR:PULM:SOUR EXT

**LFG Gen Frequency - Pulse Modulation**

Sets the repetition frequency of the internal signal. This setting affects all analog modulations which use the LF generator as the internal modulation source. With two-path instruments, the setting affects both paths.

Remote-control command:

SOUR:LFO:FREQ 20 kHz

**Pulse External Input Impedance**

(Source External only) Selects the impedance for external feed via the EXT MOD input. Selection 50 ohm and high (>100 kohm) is available.

This setting affects all analog modulations which use the external modulation source.

Remote-control command:  
SOUR:INP:MOD:IMP G50

**Polarity - Pulse Modulation**

Selects the polarity of the modulation signal.

**Normal**

The RF signal is ON while the level is HIGH.

Remote-control command:  
SOUR:PULM:POL NORM

**Inverted**

The RF signal is ON while the level is LOW.

Remote-control command:  
SOUR:PULM:POL INV

## Frequency Modulation - FM

Frequency modulation requires option R&S SMATE-B22 (FM/PhiM Modulator and Low Phase Noise). Two path instruments require a second path (R&S SMATE-B20x option) and a second option R&S SMATE-B22.R&S SMATE-B22 (FM/PhiM Modulator and Low Phase Noise)

An internal and/or external source can be selected for frequency modulation. The LF GEN modulation generator is available as the internal source.

The EXT MOD input connector for external feed is at the rear of the instrument. The coupling mode of the input (AC or DC) and 50 ohm or high (> 10 kohm) impedance can be selected.

Selection between Low Noise mode (with reduced setting range for modulation bandwidth and deviation, see data sheet) and standard mode is possible.

---

**Note:**

*It is not possible to use frequency modulation simultaneously with phase modulation.*

---

## Frequency Modulation Menu

The **Frequency Modulation** menu is opened either in the **RF/A Mod** function block or using the **MENU** key under **RF/A Mod**.

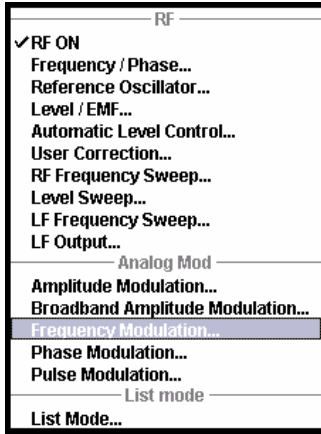

The middle section of the combined menu Pulse/Frequency/Phase Modulation provides access to the frequency modulation settings. The upper section provides access to the pulse modulation settings, see section "[Pulse Modulation](#)", page 4.102, the lower section to phase modulation, see section "[Phase Modulation - PhiM](#)", page 4.108

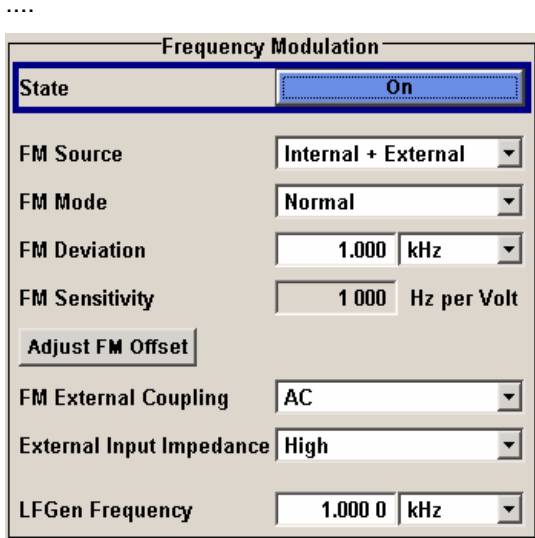

<b>State - FM</b>	<p>Activates/deactivates FM modulation.</p> <p>Activation of FM deactivates phase modulation.</p> <p>Remote-control command: SOUR:FM:STAT ON</p>
<b>FM Source - FM</b>	<p>Selects the source for the FM signal.</p>
<b>Internal</b>	<p>Selects the internal LF generator as the source for FM modulation.</p> <p>Remote-control command: SOUR:FM:SOUR INT</p>
<b>External</b>	<p>Selects the external source. The external signal is input via the EXT MOD connector.</p> <p>Remote-control command: SOUR:FM:SOUR EXT</p>
<b>Internal + External</b>	<p>Selects the internal and external source at the same time.</p> <p>Remote-control command: SOUR:FM:SOUR INT,EXT</p>
<b>FM Mode - FM</b>	<p>Selects the mode for the frequency modulation.</p>
<b>Normal</b>	<p>The maximum range for modulation bandwidth and FM deviation is available.</p> <p>Remote-control command: :SOUR:FM:MODE NORM</p>
<b>Low Noise (requires option R&amp;S SMATE-B22)</b>	<p>Frequency modulation with phase noise and spurious characteristics close to CW mode. The range for modulation bandwidth and FM deviation is reduced (see data sheet).</p> <p>Remote-control command: SOUR:FM:MODE LNO</p>

**FM Deviation**

Sets the modulation depth in Hz.

The maximal deviation depends on the RF frequency set and the selected modulation mode (see data sheet). It is possible to enter a deviation that is too high for a certain RF frequency or to vary the RF frequency to a range in which the deviation can no longer be set. In this case the maximally possible deviation is set and an error message is displayed.

Remote-control command:

:SOUR:FM:DEV 10kHz

**FM Sensitivity**

Displays the input sensitivity of the EXT MOD input in Hz/V. The display only appears in the case of external modulation.

The modulation depth entered under **FM Depth** is reached with 1 volt (=  $U_{\text{peak}}$ ) of the input signal.

**Note:**

*The input voltage should not exceed  $1.1 V_p$  otherwise modulation distortions might occur.*

Remote-control command:

SOUR:FM:SENS?

Response: "1E3"

**FM Adjust FM Offset**

Starts the adjustment for the FM/PhiM modulator. The option is adjusted with respect to DC-offset.

Remote-control command:

CAL:FMOF?

**FM External Coupling**

(Source External only) Selects the coupling mode (AC or DC) for external feed.

**Note:**

*Coupling for external feed via input EXT MOD can be set independently for modulations AM, FM and PhiM.*

**AC**

The d.c. voltage content is separated from the modulation signal.

Remote-control command:

SOUR:FM:EXT:COUP AC

**DC**

The modulation signal is not altered.

Remote-control command:

SOUR:FM:EXT:COUP DC

**FM External Input Impedance**

(Source External only) Selects the impedance for external feed via the EXT MOD input. Selection 50 ohm and high (>100 kohm) is available.

This setting affects all analog modulations which use the external modulation source.

Remote-control command:  
SOUR:INP:MOD:IMP G50

**LF Gen Frequency - FM**

(Source Internal only) Sets the frequency of the LF generator.

This setting affects all analog modulations which use the LF generator as the internal modulation source. With two-path instruments, the setting affects both paths.

Remote-control command:  
SOUR:LFO:FREQ 1E3

## Phase Modulation - PhiM

Phase modulation requires option R&S SMATE-B22 (FM/PhiM Modulator and Low Phase Noise) Two path instruments require a second RF path (R&S SMATE-B20x option) and a second option R&S SMATE-B22.R&S SMATE-B22 (FM/PhiM Modulator and Low Phase Noise)

**Note:**

*It is not possible to use phase modulation simultaneously with frequency modulation.*

An internal and/or external source can be selected for phase modulation. The LF GEN modulation generator is available as the internal source.

The EXT MOD input connector for external feed is at the rear of the instrument. The coupling mode of the input (AC or DC) and the impedance (50 ohm or < 1kohm) can be set.

Selection between three modulation modes is possible:

- **High Bandwidth** mode with full setting range for modulation bandwidth and limited PhiM deviation.
- **Low Noise** mode with reduced setting range for modulation bandwidth and deviation (see data sheet)
- **High Deviation** mode with full setting range for PhiM deviation and a reduced setting range for modulation bandwidth. Phase noise is reduced in the lower modulation frequency range (compared to **High Bandwidth** mode).



## Phase Modulation Menu

The **Phase Modulation** menu is opened either in the **RF/A Mod** function block or using the **MENU** key under **RF/A Mod**.

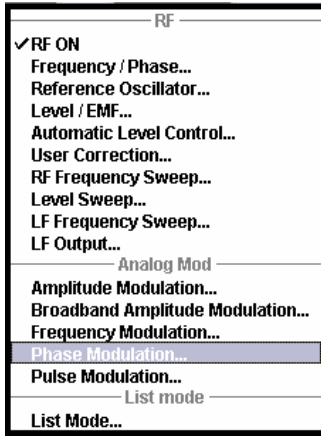

The lower section of the combined menu Pulse/Frequency/Phase Modulation provides access to the phase modulation settings. The upper section provides access to the pulse modulation settings, see section "[Pulse Modulation](#)", page 4.102, the middle section to frequency modulation, see section "

[Frequency Modulation - FM](#)", page 4.104



....

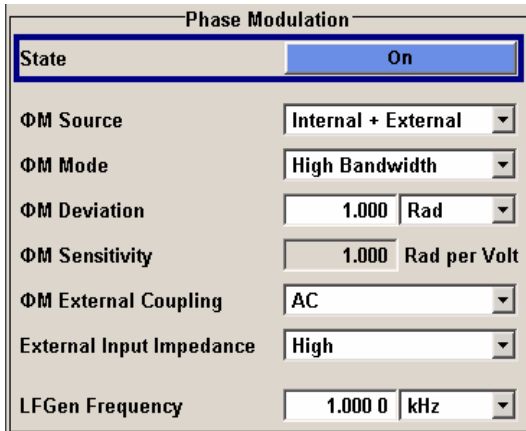

<b>State - PhiM</b>	<p>Activates/deactivates PhiM modulation.</p> <p>Activation of PhiM deactivates frequency modulation.</p> <p>Remote-control command: SOUR:PM:STAT ON</p>
<b>PhiM Source</b>	<p>Selects the source for the PhiM signal.</p> <p><b>Internal</b>      Selects the internal LF generator as the source for PhiM modulation.</p> <p>Remote-control command: SOUR:PM:SOUR INT</p> <p><b>External</b>      Selects the external source. The external signal is input via the EXT MOD connector.</p> <p>Remote-control command: SOUR:PM:SOUR EXT</p> <p><b>Internal + External</b>      Selects the internal and external source at the same time.</p> <p>Remote-control command: SOUR:PM:SOUR INT,EXT</p>
<b>PhiM Mode</b>	<p>Selects the mode for the phase modulation.</p> <p><b>High Bandwidth</b>      The maximum range for modulation bandwidth is available. However, phase noise is increased for low frequencies. The range for PhiM deviation is limited.</p> <p>This mode is recommended for high modulation frequencies.</p> <p>Remote-control command: SOUR:PM:MODE HBAN</p> <p><b>High Deviation</b>      The maximum range for PhiM deviation is available. Phase noise is improved for low frequencies compared to <b>High Bandwidth</b> mode. The range for modulation frequency is limited (see data sheet).</p> <p>This mode is recommended for low modulation frequencies and/or high PhiM deviation.</p> <p>Remote-control command: SOUR:PM:MODE HDEV</p>

**Low Noise**  
(with option B22 only)  
Phase modulation with phase noise and spurious characteristics close to CW mode. The range for modulation bandwidth and PM deviation is limited (see data sheet).

Remote-control command:  
SOUR:PM:MODE LNO

**PhiM Deviation**

Sets the modulation depth in RAD or degrees.

The maximal deviation depends on the RF frequency set and the selected modulation mode (see data sheet). It is possible to enter a deviation that is too high for a certain RF frequency or to vary the RF frequency to a range in which the deviation can no longer be set. In this case the maximally possible deviation is set and an error message is displayed.

Remote-control command:  
SOUR:PM:DEV 10kHz

**PhiM Sensitivity**

Displays the input sensitivity of the EXT MOD input in RAD/V. The display only appears in the case of external modulation.

The modulation depth entered under **PhiM Depth** is reached with 1 volt ( $=U_{\text{peak}}$ ) of the input signal.

**Note:**

*The input voltage should not exceed 1.1 V<sub>p</sub> otherwise modulation distortions might occur.*

Remote-control command:  
SOUR:PM:SENS?

**PhiM External Coupling**

Selects the coupling mode (AC or DC) for external feed.

**Note:**

*Coupling for external feed via input EXT MOD can be set independently for modulations AM, FM and PhiM.*

**AC**

The d.c. voltage content is separated from the modulation signal.

Remote-control command:  
SOUR:PM:EXT:COUP AC

**DC**

The modulation signal is not altered.

Remote-control command:  
SOUR:PM:EXT:COUP DC

**PhiM External Input Impedance**

Selects the impedance for external feed via the EXT MOD input. Selection 50 ohm and high impedance (>100 kohm) is available.

This setting affects all analog modulations which use the external modulation source.

Remote-control command:  
SOUR:INP:MOD:IMP G50

**LF Gen Frequency - PhiM**

(Source Internal only) Sets the frequency of the LF generator.

This setting affects all analog modulations which use the LF generator as the internal modulation source.

Remote-control command:  
SOUR:LFO:FREQ 1E3

# I/Q Modulation

## Introduction - I/Q Modulation

The R&S Vector Signal Generator offers I/Q modulation with external analog I/Q signals as well as internal digital signals.

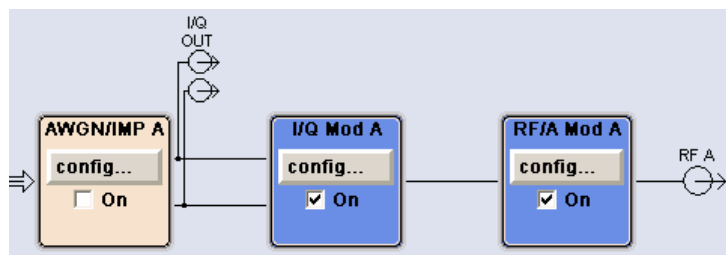

In the case of Path A, I/Q modulation with an external analog I/Q signal is possible for the basic unit (R&S SMATE with frequency option R&S SMATE-B10x) without additional equipment options. The basic equipment configuration for generating an internal baseband signal includes the options R&S SMATE-B13 (Baseband Main Module) and R&S SMATE-B10/B11 (Unicod and ARB).

In the case of Path B, external signals cannot be fed into the I/Q modulator. The second I/Q modulator is available if the option R&S SMATE-B20x (Path B), a second R&S SMATE-B13 option (Baseband Main Module), and one of the options R&S SMATE-B10/B11 (Baseband Generator), R&S SMATE-B17 (External Baseband Input) or R&S SMATE-K62 (Noise Generator) are installed.

The external signal is input via the **I** and **Q** connector and transferred directly to the I/Q modulator of Path A (**I/Q Mod A** function block).

The internally generated baseband signal is configured in the **Baseband** function block (see the section "Baseband Signal - Baseband"). Before the signal is fed into the I/Q modulator, the signal can be faded (**Fading** function block), noise can be added and/or the signal can be impaired. Impairment at this point along the signal flow is offered to allow a signal to be output at the I/Q-OUT outputs (a signal which, for example, compensates signal distortion in a connected test object (DUT)).

Impairment is integrated in the option R&S SMATE-B13 (Baseband Main Module). The generation of noise requires the option R&S SMATE--K62 (AWGN).

In the case of two-path instruments, the baseband signals of both paths can be added with or without frequency offset.

The input signal of the I/Q modulator is selected in the **I/Q Mod** function block (see the following section "[I/Q Modulator - I/Q MOD](#)", page 4.114).

If the external analog signal is fed into the I/Q modulator, the input signal "**Analog Wideband I/Q In**" must be selected. The maximum RF bandwidth is available (see data sheet).

If the internally generated baseband signal is input the input signal "**Internal Baseband I/Q In**" must be selected. The RF bandwidth is reduced (see data sheet). This setting is always active for Path B.

Impairments can also be set in the **I/Q Mod** menu to allow an externally applied analog I/Q signal to be impaired. An internal baseband signal can thus be impaired both digital (in the **Impairment** block in the **Impairment** menu) and analog in the I/Q modulator. If impairments are set in both menus, they superimpose each other in the signal.

# I/Q Modulator - I/Q MOD Function Block

The input signal of the I/Q modulator is selected and the **I/Q Settings** menu opened in the **I/Q Mod** function block.



The **I/Q Settings** menu containing the modulation settings is opened in the top section.

The input signal is selected in the **I/Q Mod In** section and also in the **I/Q Settings** menu.

See following section "I/Q Settings Menu", page 4.114

## I/Q Settings Menu

The menu for setting the I/Q modulation parameters is opened either in the **I/Q Mod** function block or in the menu with the same name which is opened using the **MENU** key.

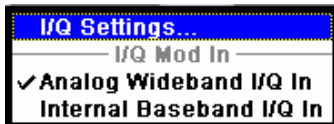

**Notes:**

*It is not possible to use I/Q modulation with an external analog signal (**Analog Wideband I/Q In**) simultaneously with AM, broadband AM, digital modulation and digital standards, fading, noise, arbitrary waveform generation, multicarrier CW and external baseband input.*

*System error correction of the I/Q modulator permits precise and repeatable measurements. The correction routine should be called in the case of temperature fluctuations of several degrees. The routine is called in the **Internal Adjustment** submenu, **SETUP** key - **System** menu .*

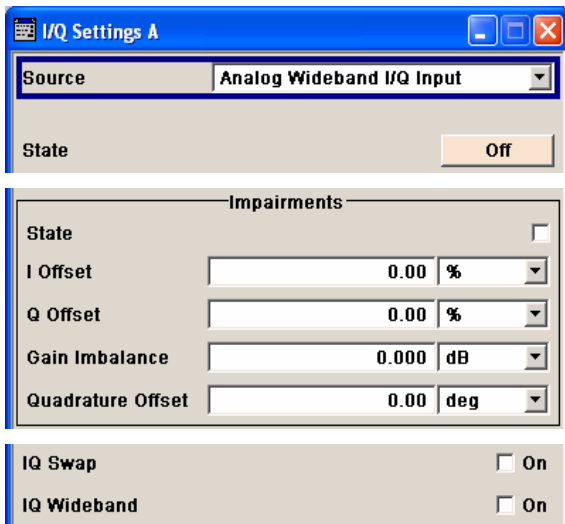

I/Q modulation is activated and the source entered in the top section of the menu

I/Q impairment for specific impairment of the I/Q modulation is set in the **Impairments** section.

I/Q control can be swapped in the lower section of the menu and the optimized settings for wideband modulation signals can be activated.

The screenshot shows a menu titled "Analog Wideband I/Q Input". It contains two settings:

- Crest Factor:** A text box containing "0.00" followed by a dropdown menu set to "dB".
- Gain:** A dropdown menu set to "3 dB (Best For High 3GPP ACLR)".

The bottom section of the menu differs depending on the selected input signal (**Analog Wideband I/Q Input** or **Internal Baseband**).

The crest factor is input for the external signal.

The gain is selected for the internal and external signal.

I/Q modulation is activated and the source entered in the top section of the menu.

### **IQ Source - I/Q Mod**

Selects the input signal for the I/Q modulator. This selection is only available for Path A.

#### **Analog Wideband I/Q In**

Selects an external analog signal as the input signal. The signal must be applied at the inputs **I** and **Q**.

Remote-control command:

SOUR:IQ:SOUR ANAL

#### **Internal Baseband I/Q In**

Selects the internal baseband signal as the input signal. This setting requires the additional equipment options for generating the various baseband signals.

Remote-control command:

SOUR:IQ:SOUR BAS

### **State - I/Q Mod**

Activates/deactivates I/Q modulation .

If **Analog Wideband I/Q In** is selected, the I/Q modulator is also deactivated and activated.

If **Internal Baseband I/Q In** is selected, the I/Q modulator is always activated automatically as soon as signal generation is activated in the **Baseband** block. It can, however, be deactivated later, e.g. if only the baseband signal which is output at the I/Q outputs is relevant.

Remote-control command:

SOUR:IQ:STAT ON | OFF

I/Q impairment for specific impairment of the I/Q modulation is set in the **Impairments** section.

**State - Impairments I/Q Mod**

Activates/deactivates I/Q impairment.

If activated, the settings for leakage, I/Q imbalance and quadrature offset become effective.

Whether or not I/Q impairment is activated is indicated in the function block.

---

**Note:**

*It is advisable to switch automatic level control to the Sample&Hold mode, as otherwise level errors may occur (RF / Ana Mod – Automatic Level Control menu).*

---

Remote-control command:

SOUR:IQ:IMP:STAT ON | OFF

**Offset - I/Q Mod**

Sets the carrier offset (in percent) of the amplitudes (scaled to the peak envelope power (PEP) for the I and/or Q signal component).

An ideal I/Q modulator suppresses the carrier offset completely (offset = 0 percent). If an offset value is entered for a component, a carrier offset with fixed amplitude is added to the signal. In the diagram, all I values or Q values are offset by a fixed amplitude value depending on the entered percentage.

Effect of offset for the I component:

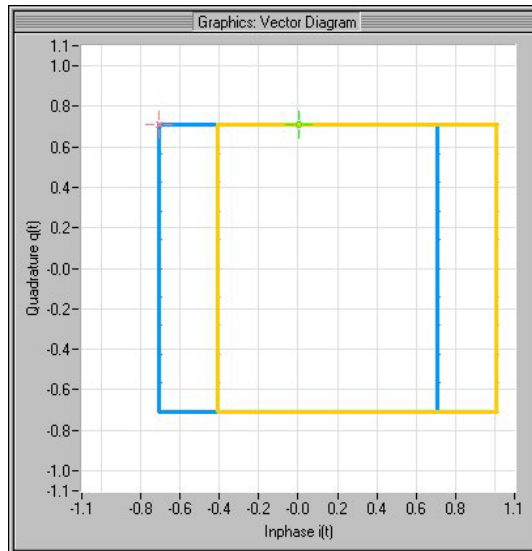



Effect of offset for the Q component:

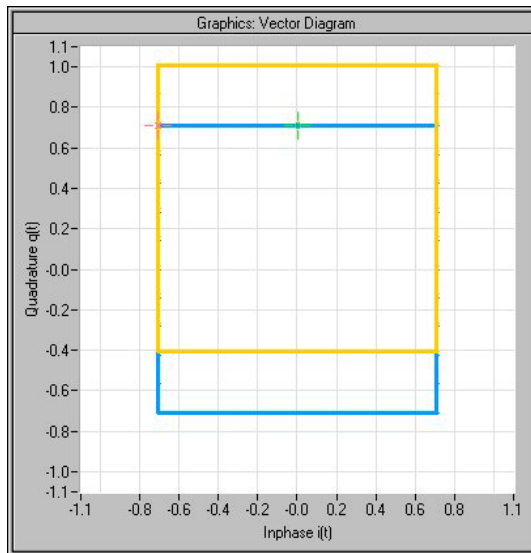

Effect of an identical offset for both signal components:

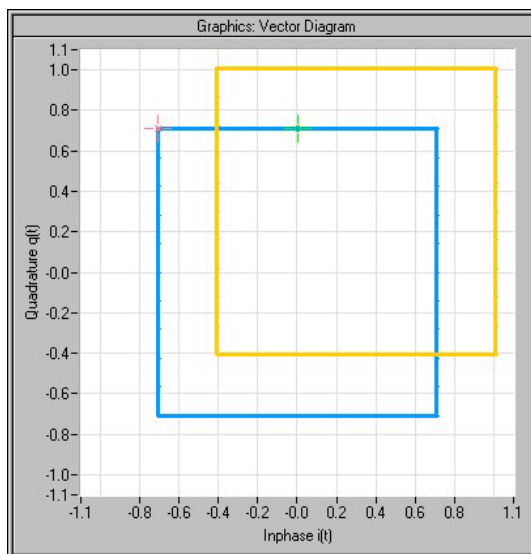

Remote-control command:

```
SOUR:IQ:IMP:LEAK:I 10PCT
SOUR:IQ:IMP:LEAK:Q 10PCT
```

**Gain Imbalance - I/Q Mod**

Sets the imbalance of the I and Q vector.

The entry is made in dB (default) or %, where 1 dB offset is roughly 12 % according to the following:

$$\text{Imbalance [dB]} = 20\log ( | \text{Gain}_Q | / | \text{Gain}_I | )$$

An ideal I/Q modulator amplifies the I and Q signal path by exactly the same degree. The imbalance corresponds to the difference in amplification of the I and Q channel and therefore to the difference in amplitude of the signal components. In the vector diagram, the length of the I vector changes relative to the length of the Q vector.

Positive values mean that the Q vector is amplified more than the I vector by the corresponding percentage:

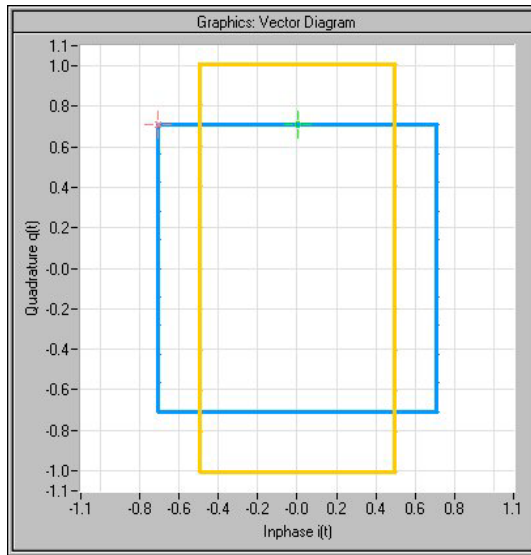

Negative values mean that the I vector is amplified more than the Q vector by the corresponding percentage:

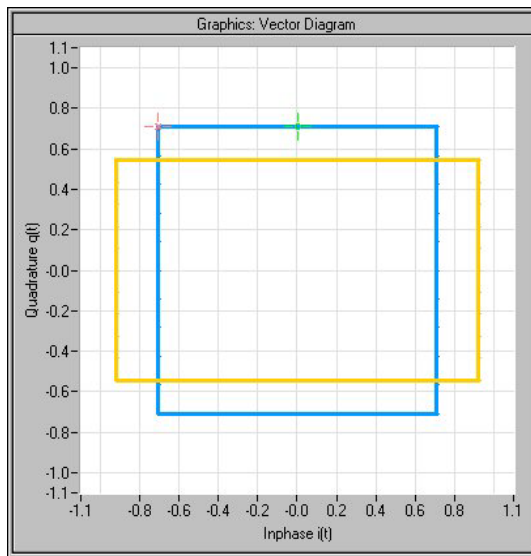

Remote-control command:

```
SOUR:IQ:IMP:IQR:MAGN -5PCT
```

**Quadrature Offset - I/Q Mod** Sets the quadrature offset.

An ideal I/Q modulator sets the phase angle to exactly 90 degrees. With a quadrature offset, the phase angle between the I and Q vector deviates from the ideal 90 degrees, the amplitudes of both components are of the same size. In the vector diagram, the quadrature offset causes the coordinate system to shift.

A positive quadrature offset means a phase angle greater than 90 degrees:

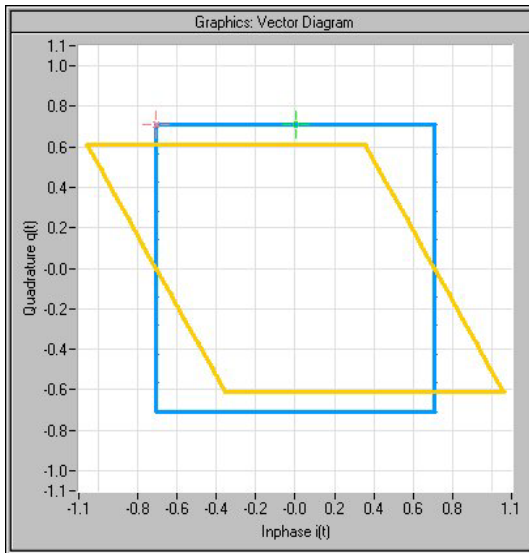

A negative quadrature offset means a phase angle less than 90 degrees:

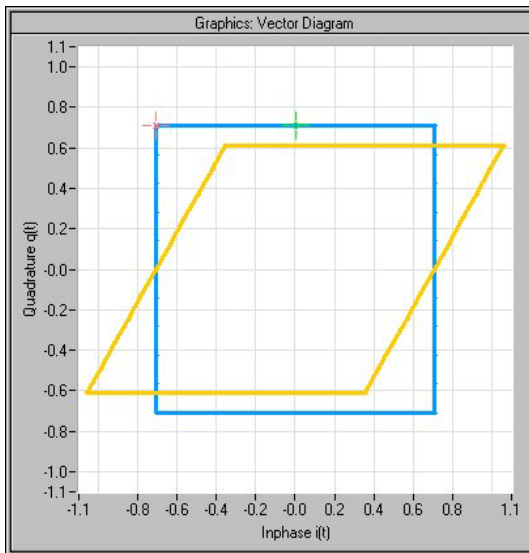

Remote-control command:  
 SOUR:IQ:IMP:QUAD:ANGL 4DEG

The I/Q control can be swapped and the optimized setting for wideband signals can be selected in the middle section of the menu.

### I/Q-Swap - I/Q Mod

Selects normal or swapped I/Q control for an external analog signal. The modulation sidebands are inverted by swapping the I and Q signals.

This parameter enables I/Q modulation to be performed on signals according to IS2000 (cdma2000 standard) and the majority of all other standards. As a result, an I/Q demodulator defined according to IS2000 can also be used for demodulating the generated signals.

The I/Q modulator defined in the IS2000 standard differs from the definition in the R&S Vector Signal Generator. The definition on which the R&S Vector Signal Generator is based is used by virtually all digital communication standards (except IS95 and IS2000).

In the final step, the filtered I/Q signal is modulated to the desired RF in a different way in the I/Q modulator:

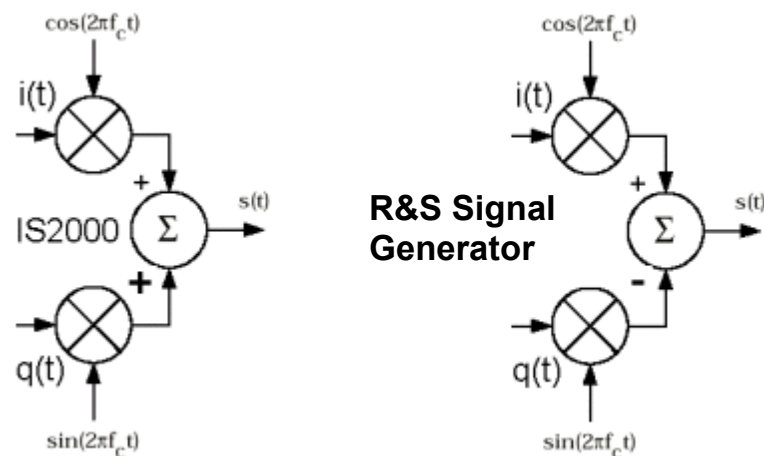

Fig. 4-2 Definition of I/Q modulator in IS2000 and R&S Vector Signal Generator

According to IS2000, the RF signal  $s(t)$  is derived from the baseband I/Q signal as follows:

$$s(t) = i(t) \cos(2\pi f_c t) + q(t) \sin(2\pi f_c t)$$

The R&S Vector Signal Generator is based on the following definition:

$$s(t) = i(t) \cos(2\pi f_c t) - q(t) \sin(2\pi f_c t)$$

**I/Q Swap** must now be set to **On** so that an I/Q modulator defined according to IS2000 can cope with the RF signal generated by the R&S Vector Signal Generator.

#### Off

I/Q control is normal.

Remote-control command:

SOUR:IQ:SWAP:STAT OFF

**On** The I and Q signals are swapped.  
 Remote-control command:  
 SOUR:IQ:SWAP:STAT ON

**I/Q-Wideband - I/Q Mod** Optimized setting for wideband modulation signals (>5 MHz).

The modulation frequency response is decreased at the expense of poorer harmonic suppression. This is achieved by shifting the switching frequencies of the lowpass filters in the output section.

Remote-control command:  
 SOUR:IQ:WBST ON

In the bottom section of the menu the crest factor is input for the external signal and the gain is selected for the internal and external signal (**Analog Wideband I/Q Input** or **Internal Baseband**).

**Crest Factor - I/Q Mod** (Analog Wideband I/Q Input only) Sets the crest factor of the external analog signal.

The crest factor gives the difference in level between the peak envelope power (PEP) and average power value (RMS) in dB.

This value is necessary to allow the correct output power to be generated at the RF output. When the set output power is generated, the R&S Vector Signal Generator uses this value to compensate the average power which is lower compared to the peak power.

The maximum input voltage at the I/Q input is equated to the peak power and is used as the "reference" for setting the level of the output signal. Since the signal does not usually supply the peak power at a constant level and instead supplies a lower average power, the crest factor specifies how many dB have to be added internally so that the correct output power is achieved.

Remote-control command:  
 SOUR:IQ:CRES 10

**Baseband Gain-Gain - I/Q Mod** Optimizes the modulation of the I/Q modulator for any measurement requirement.

The modulation is determined by selecting the gain.

---

**Note:**

*The remote-control commands to be used depend on the selected I/Q input signal (SOURce:IQ:SOURce ANALog | BASeband). For the Analog Wideband I/Q input signal (SOURce:IQ:SOURce ANALog), the commands of system SOURce:IQ:GAIN are valid. For the internal or external Baseband I/Q input signal (SOURce:IQ:SOURce BASeband), the commands of system SOURce:BB:IQGain are valid.*

---

<b>Auto (digital baseband signal only)</b>	<p>With this setting, the modulation is automatically optimized for the internally set baseband signal.</p> <p>Remote-control command: SOUR:BB:IQG AUTO (digital I/Q signal)</p>
<b>- 3dB (Low Distortion)</b>	<p>Activates -3 dB gain. With this setting, signal distortions are minimized.</p> <p>Remote-control command: SOUR:IQ:GAIN DBM3 (analog I/Q signal) SOUR:BB:IQG DBM3 (digital I/Q signal)</p>
<b>0 dB (Standard)</b>	<p>Activates 0 dB gain</p> <p>Remote-control command: SOUR:IQ:GAIN DB0 (analog I/Q signal) SOUR:BB:IQG DB0 (digital I/Q signal)</p>
<b>3 dB (High 3GPP ACLR)</b>	<p>Activates 3 dB gain. This setting is recommended for 3GPP signals with very high adjacent channel power ratio (ACPR).</p> <p>Remote-control command: SOUR:IQ:GAIN DB3 (analog I/Q signal) SOUR:BB:IQG DB3 (digital I/Q signal)</p>
<b>6dB (Low Noise)</b>	<p>Activates 6 dB gain. With this setting, signal noise is minimized.</p> <p>Remote-control command: SOUR:IQ:GAIN DB6 (analog I/Q signal) SOUR:BB:IQG DB6 (digital I/Q signal)</p>

# Impairment of Digital I/Q Signal and Noise Generator - AWGN-IMP Block

## Introduction - Impairments and AWGN

The R&S Vector Signal Generator allows the digital I/Q signal to be impaired before it is passed on to the I/Q modulator, and also noise to be added to the signal. The noise generator can also be used to generate a pure noise signal.

These settings are available in the block diagram in the "**AWGN / IMP**" function block as well as in the menu with the same name which is opened using the **[MENU]** key .

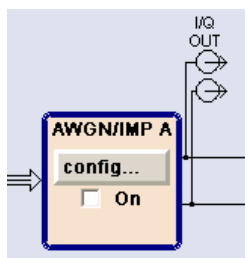

The equipment options for the basic unit (R&S SMATE with frequency option R&S SMATE-B10x) include the option R&S SMATE-B13 (Baseband Main Module) for **Impairments** and the option R&S SMATE-K62 (Noise Generator) for **AWGN**.

Two-path instruments require a second RF path (option R&S SMATE-B20x) and a second R&S SMATE-B13 option (Baseband Main Module) for impairment of a signal on Path B. Noise can be generated alternately for both paths using an option R&S SMATE-K62 (Noise Generator). Simultaneous noise generation on both paths requires a second option.

The baseband signal is output at the I/Q output connectors **I Out** and **Q Out** on the rear panel of the instrument. The single ended or differential output (option R&S SMATE-B16, Differential Output) is configured in sub menu **I/Q Out...**

In the case of two-path instruments, these connectors can be assigned either to Path A or Path B.

**IQ Out - AWGN - IMP Block** Selects the path to which the I/Q output connectors are assigned (two-path instruments only).

**Settings....** Opens the submenu to set the output type and voltages, see following section "*Differential Output*". The menu is only available when option Differential Outputs (R&S SMATE-B16) is fitted.

Remote-control command: n . a .

**I/Q Out from A** The I/Q output connectors are assigned to Path A.

Remote-control command:  
SOUR:BB:IQO:SOUR A

**I/Q Out from B** The I/Q output connectors are assigned to Path B.

Remote-control command:  
SOUR:BB:IQO:SOUR B

# Differential Output

The differential output of the Vector Signal Generator provides symmetrical signals for differential inputs of DUTs without the need of additional external electric network. The operating point of the inputs can be set by a definable DC-voltage (bias). In addition an offset between inverting and non-inverting output can be set to balance a difference of the best operating points.

The differential output can be assigned either to path A or path B (**Impairment block - I/Q Out**).

The equipment options for the basic unit (R&S SMU with frequency option R&S SMATE-B10x) include the option R&S SMATE-B13 (Baseband Main Module) and the option R&S SMATE-B16 (Differential Output) for **I/Q Out**....

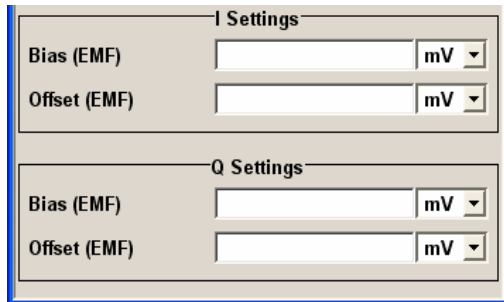

**Optimize IQ-Signals for RF Output - Differential Outputs - IMP Block**

Activates/deactivates optimization of level accuracy and imbalance for RF Output.

Level accuracy and imbalance can be either optimized for RF output (active) or for differential outputs (not active).

With a second option Baseband Main Module (R&S SMATE-B13) it is possible to optimize a signal for RF output in one path and for the differential output in the other path.

Remote-control command:

```
SOUR:IQ:OUTP:BIAS:OPT:STAT ON
```

**Output Type - Differential Outputs - IMP Block**

Selects the type of output. The menu changes depending on the selection

**Differential**

Differential output at **I OUT** and **I OUT BAR** / **Q OUT** and **Q OUT BAR**. The analog I/Q signal components are output at I/Q OUT and I/Q OUT BAR. A bias to set the operating point of DUT can be defined. In addition an offset between inverting and non-inverting output can be set to balance a difference of the best operating points.



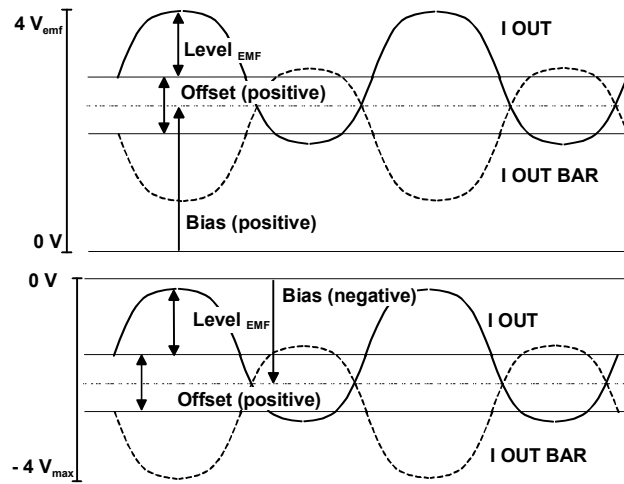

Remote-control command:  
`SOUR:IQ:OUTP:TYPE DIFF`

**Single Ended**

Single-ended output at **I OUT** and **Q OUT**. A bias between I/Q OUT and ground can be defined.

Remote-control command:  
`SOUR:IQ:OUTP:TYPE SING`

**Output Mode - Differential Outputs - IMP Block**

Selects the mode for setting the outputs - independent or together. The menu changes depending on the selection here.

**Fixed**

The settings for the I/Q signal components are fixed and cannot be changed.

**Level Vp-p (EMF) (Single ended) = 1.0 V**

**Level Vp-p (EMF) (Differential) = 2.0 V**

**Bias = 0 V**

**Offset = 0 V**

Remote-control command:  
`SOUR:IQ:OUTP:MODE FIX`

**Variable**

The settings for the I/Q signal components are not fixed and can be modified.

Remote-control command:  
`SOUR:IQ:OUTP:MODE VAR`

**I/Q Level EMF - Differential Outputs - IMP Block**

Sets the output voltage for both signal components. Small differences at the inputs can be taken into account via impairment settings (see following section "[Impairment Settings Menu](#)")

**Differential Output:**

Value range:  $\pm 2,0$  Volt (corresponds to 0 ... 4 Volt open-circuit voltage). The maximum overall output voltage (**Level EMF + Bias + Offset**) is 4 volts.

**Single ended Output:**

Value range:  $\pm 1,0$  Volt (corresponds to 0 ... 2 Volt peak-peak).

Remote-control commands:

```
SOUR:IQ:OUTP:LEV 0.1
```

**Couple IQ Bias - Differential Outputs - IMP Block**

Activates/deactivates coupling of bias setting of the I-signal and Q-signal component. For activated coupling, the setting can be made for the I-signal component, it automatically applies to the Q-signal component as well. The fields for setting the Q-signal component are shaded.

Remote-control command:

```
SOUR:IQ:OUT:BIAS:COUP:STAT ON
```

In menu area **I Settings** and **Q Settings** the bias and offset settings are made.

**Bias - Differential Outputs - IMP Block**

(EMF) Sets the bias. A DC voltage is superimposed upon the I or Q signal. The maximum overall voltage (Level EMF + Bias + Offset) is 4 volts.

Remote-control commands:

```
SOUR:IQ:OUTP:BIAS:I -0.5V
```

```
SOUR:IQ:OUTP:BIAS:Q 0.5V
```

**Offset - Differential Outputs  
- IMP Block**

Sets an offset between the inverting and the non-inverting output. The maximum overall voltage (**Level EMF + Bias + Offset**) is 4 Volt. The set value is set half in the positive and half in the negative direction:

A positive offset is set with half of the value in positive direction at the non-inverting outputs, in negative direction at the inverting outputs, respectively.

For example, if a 100.0 mV offset value is set for the I signal component, the output signal at **I OUT** will have a 50.0 mV offset and the output signal at **I OUT Bar** will have a - 50.0 mV offset.

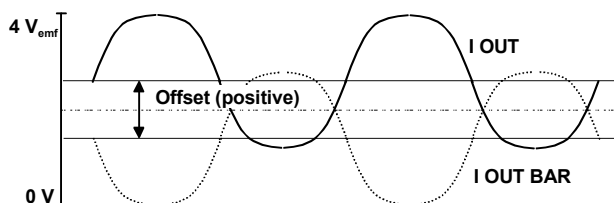

A negative offset is set with half of the value in negative direction at the non-inverting outputs, in positive direction at the inverting outputs, respectively.

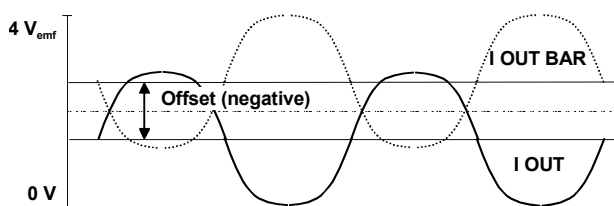

This setting is available only for output type **Differential**.

Remote-control commands:

```
SOUR:IQ:OUTP:OFFS:I 0.01V
```

```
SOUR:IQ:OUTP:OFFS:Q 0V
```

## Introduction - Impairments

Impairment of the digital I/Q signal prior to input into the I/Q modulator can be used, for example, to compensate the distortion of a test object or to check the effect of a disturbed signal on a test object. For this purpose, the I/Q signal can be output at the **I/Q Out** outputs. On the other hand, the I/Q impairments used internally for compensating signal distortion can be deactivated by the I/Q modulator in order to, for example, test its own baseband components.

---

### Note:

*In addition to impairment of the digital I/Q signal, the R&S Vector Signal Generator also allows impairment of the analog signal to be set in the I/Q modulator. The relevant settings are made in the **I/Q Mod** function block (see the section "[I/Q Modulation](#)", on page 4.114).*

---

# Impairment Settings Menu

The **Impairment Settings** menu for setting the digital I/Q impairments is opened either in the **AWGN / IMP** function block or using the **[MENU]** key under **AWGN / IMP**.

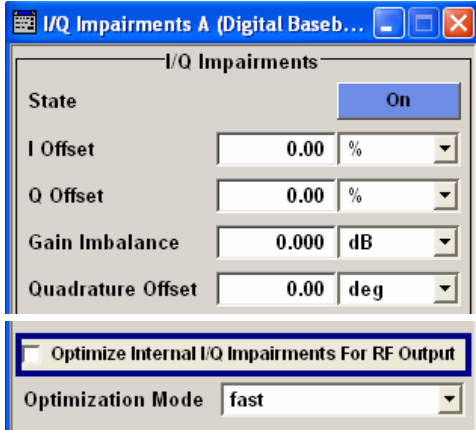
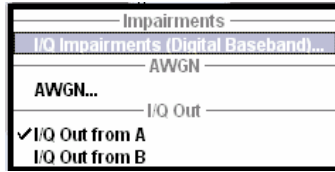

I/Q impairment is activated and set in the **I/Q Impairments** section.

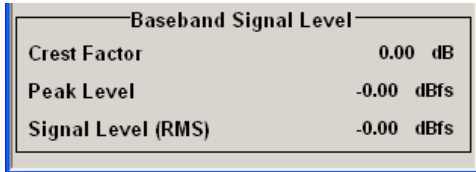

Internal compensation of signal distortions by the I/Q modulator is activated / deactivated in the middle section.

The signal levels and the crest factor of the baseband signal at the I/Q outputs connectors are indicated in the bottom section.

This information is needed by the user, for example, in order to use the I/Q signal externally and to adjust the level correctly there, or to see how the signal is modulated.

I/Q impairment is activated and set in the **I/Q Impairments** section.

**State - Digital Impairments** Activates/deactivates digital I/Q impairment.

When activated, the settings for carrier leakage, I/Q imbalance and quadrature offset become effective.

Internal predistortion for compensating the I/Q modulator is not influenced by this setting.

Remote-control command :  
 SOUR:BB:IMP:STAT ON

**I/Q Offset - Digital Impairments**

Sets the carrier leakage (in percent) of the amplitudes (scaled to the peak envelope power (PEP)) for the I and/or Q signal component.

An ideal I/Q modulator suppresses the carrier leakage completely (offset = 0 percent). If an offset is entered for a component, a carrier leakage with fixed amplitude is added to the signal. In the diagram, all I values or Q values are offset by a fixed amplitude value depending on the entered percentage.

Effect of offset for the I component:

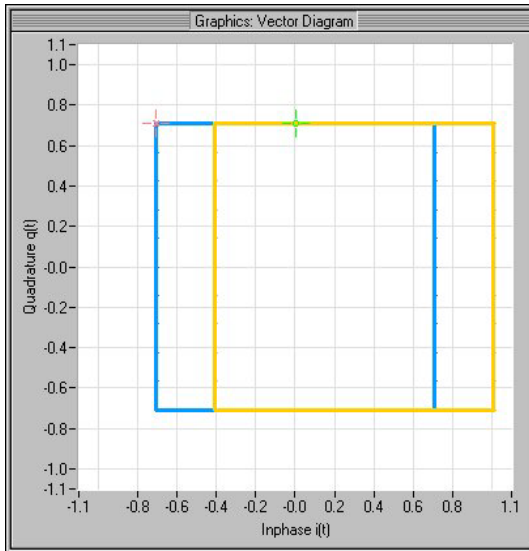

Effect of offset for the Q component:

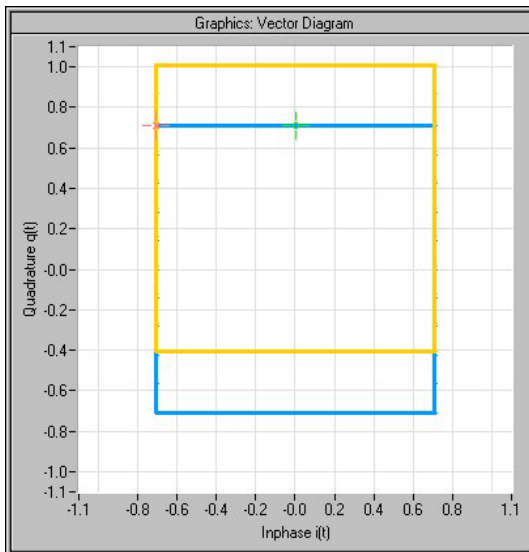

Effect of an identical offsets for both signal components:

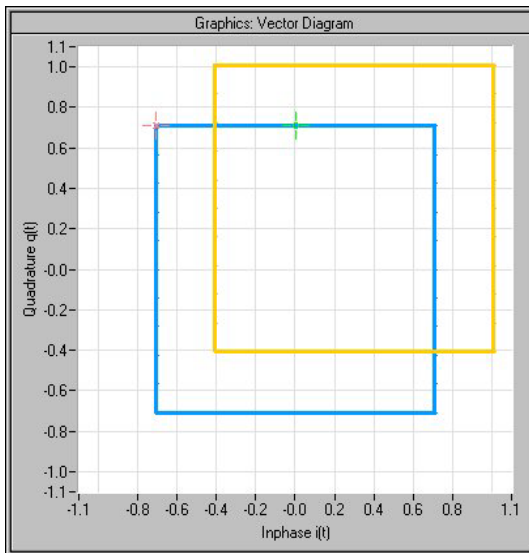

Remote-control commands:

SOUR:BB:IMP:LEAK:I 6PCT

SOUR:BB:IMP:LEAK:Q 6PCT

**Gain Imbalance - Digital Impairments**

Sets the imbalance of the I and Q vector.

The entry is made in dB (default) or %, where 1 dB offset is roughly 12 % according to the following:

$$\text{Imbalance [dB]} = 20\log ( | \text{Gain}_Q | / | \text{Gain}_I | )$$

An ideal I/Q modulator amplifies the I and Q signal path by exactly the same degree. The imbalance corresponds to the difference in amplification of the I and Q channel and therefore to the difference in amplitude of the signal components. In the vector diagram, the length of the I vector changes relative to the length of the Q vector.

Positive values mean that the Q vector is amplified more than the I vector by the corresponding percentage:

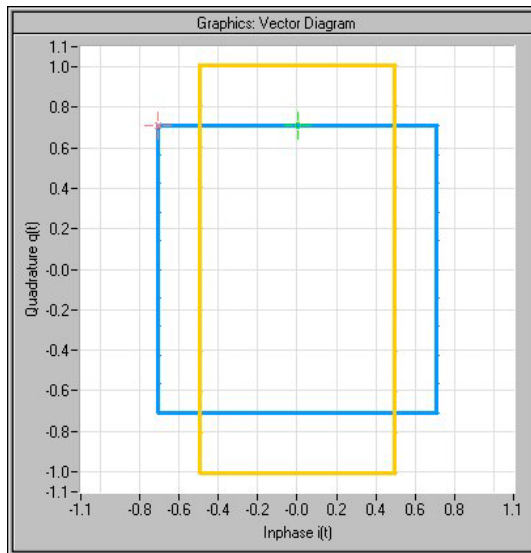

Negative values mean that the I vector is amplified more than the Q vector by the corresponding percentage:

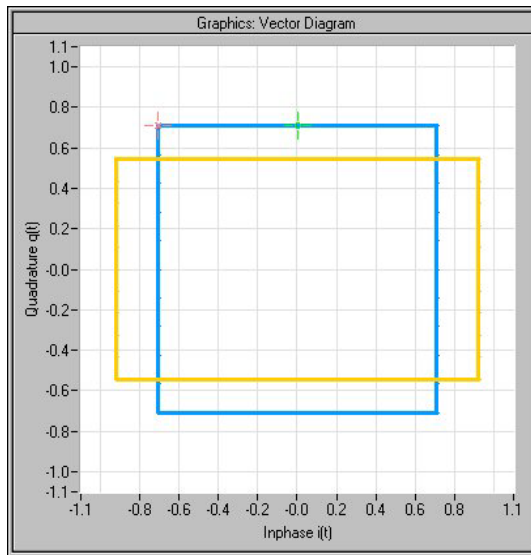

Remote-control command:  
SOUR:BB:IMP:IQR 0.1



**Quadrature Offset - Digital Impairments**

Sets the quadrature offset.

An ideal I/Q modulator sets the phase angle to exactly 90 degrees. With a quadrature offset, the phase angle between the I and Q vector deviates from the ideal 90 degrees, the amplitudes of both components are of the same size. In the vector diagram, the quadrature offset causes the coordinate system to shift.

A positive quadrature offset means a phase angle greater than 90 degrees:

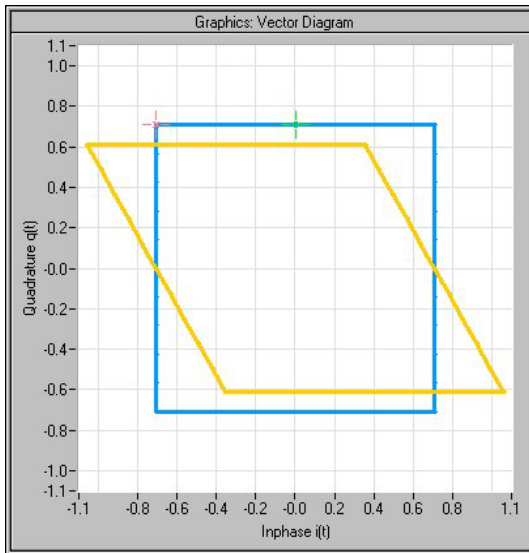

A negative quadrature offset means a phase angle less than 90 degrees:

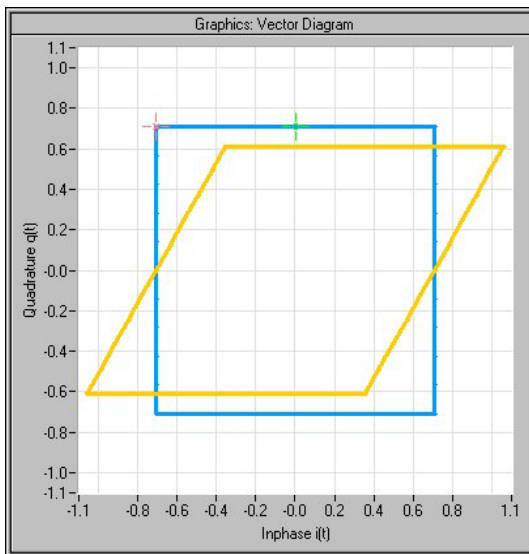

Remote-control command:  
 SOUR:BB:IMP:QUAD:ANGL 5DEG

**Optimize internal IQ-Impairments for RF Output - Digital Impairments** Activates/deactivates internal compensation of signal distortions by the I/Q modulator.  
 Remote-control command:  
 SOUR:BB:IMP:OPT:STAT ON

**Optimization Mode - Digital Impairments** Selects the optimization mode

**Fast** Optimization is reached by compensation for I/Q skew.

Remote-control command:  
 SOUR:BB:IMP:OPT:MODE FAST

**High Quality** Optimization is reached by compensation for I/Q skew and frequency response correction.

Remote-control command:  
 SOUR:BB:IMP:OPT:MODE QHIG

The signal levels and the crest factor of the baseband signal at the I/Q-output connectors are indicated in the bottom section.

**Crest Factor - Digital Impairments** Indicates the crest factor of the baseband signal.  
 The crest factor is calculated from the two level parameters as follows:  

$$\text{Crest / dB} = \text{Peak\_Level/dBFs} - \text{Signal\_Level/dBFs}$$
  
 Remote-control command:  
 :SOUR:BB:CFAC?

**Peak Level - Digital Impairments** Indicates the peak level of the baseband signal relative to full scale of 0.5 V (in terms of dB full scale).  
 Remote-control command:  
 :SOUR:BB:POW:PEAK?

**Signal Level (RMS)- Digital Impairments** Indicates the rms level of the baseband signal relative to full scale of 0.5 V (in terms of dB full scale).  
 Remote-control command:  
 :SOUR:BB:POW:RMS?

## Introduction - Noise Generator - AWGN

The noise generator generates an AWGN signal (Additive White Gaussian Noise) in the digital baseband, i.e. the noise power density has a Gaussian distribution and is distributed evenly across the frequency. This noise signal superimposes the (interference-free) useful signal (**Additive Noise** mode). Typical applications for the noise generator are bit-error or block-error measurements, depending on the set C/N ratio.

The Gaussian noise is generated by means of feedback shift registers with subsequent probability transformation. The switching configuration is such that virtually ideal statistical characteristics are achieved:

- I and Q paths are decorrelated from each other.
- The crest factor of 18 dB allows very small probabilities to be realized.
- The period of the noise signal depends on the selected system bandwidth. The relationship of period P to system bandwidth  $B_{\text{sys}}$  is approximated:
- $P \approx 1 \cdot 10^{13} / B_{\text{sys}}$

This results in periods between 317 years with minimum bandwidth and approximately 2 days with maximum bandwidth.

This results in a period of approximately one month for 3GPP FDD with a bandwidth of 3.84 Mcps, and a period of 427 days for GSM with 270.833 kcps.

Scalable low-pass filters are used to produce a noise level with both a broad dynamic range and a broad bandwidth range (from 1 kHz to 60 MHz).

Apart from the **Additive Noise** mode, there are also the **Noise Only** and the **CW Interferer** mode. In the **Noise Only** mode a pure noise signal is generated and modulated to the carrier. In the **CW Interferer** mode, a sinusoidal signal with an adjustable frequency offset to the baseband signal is generated and added to the baseband signal by means of a counter instead of a shift register.

## AWGN Settings Menu

The **AWGN Settings** menu for setting the noise generator is opened either in the **AWGN / IMP** function block or in the menu tree of the **MENU** key under **AWGN Settings**.

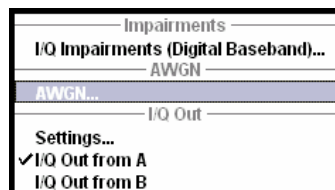

The **AWGN Settings** menu is divided into the following sections.

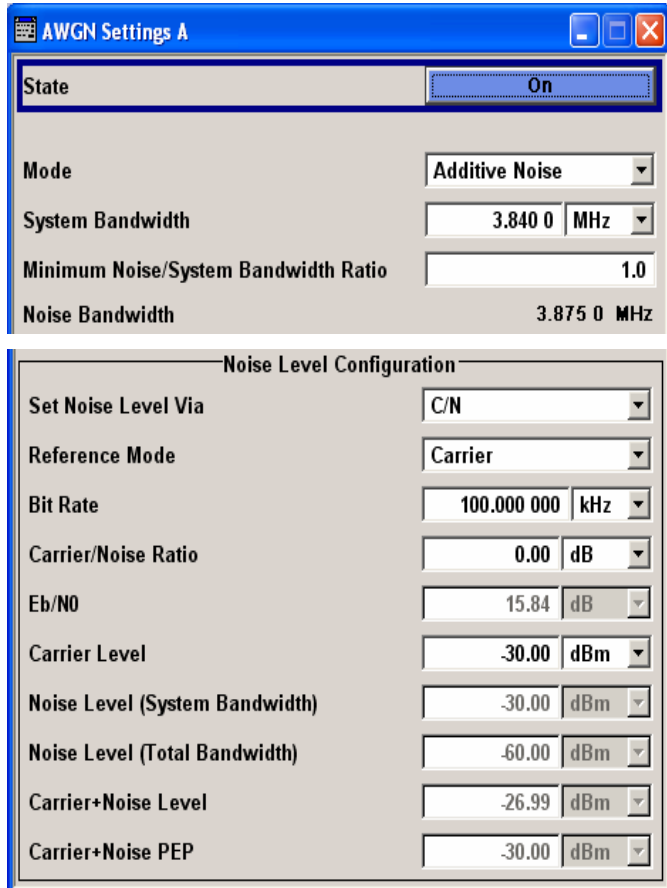

The RFI signal generator is activated, the mode selected and the interfering signal is configured in the top section of the menu.

The level of the interfering signal is configured in the **Noise Level Configuration** section.

In **Additive Noise** and **CW interferer** mode, the interfering level can be defined and the resulting total level displayed here.

In **Noise Only** mode, only the noise level can be set here.

The RFI signal generator is activated, the mode selected and the interfering signal is configured in the top section of the menu.

**State - AWGN**

Activates/deactivates the RFI signal generator. The interferer (AWGN or CW interferer, depending on the selected mode) is generated as after the generator is activated.

Remote-control command:  
`SOUR:AWGN:STAT ON`

**Mode - AWGN**

Selects the mode for generating the interfering signal.

**Additive Noise**

The AWGN noise signal with selectable system bandwidth is added to the baseband signal.

Remote-control command:  
`SOUR:AWGN:MODE ADD`

**Noise Only** The pure AWGN noise signal with selectable system bandwidth is modulated to the carrier. The connection to the baseband is interrupted.

Remote-control command:  
SOUR:AWGN:MODE ONLY

**CW Interferer** A sine with a defined frequency offset is added to the baseband signal. The calculation of  $E_b / N_0$  ratio is omitted.

Remote-control command:  
SOUR:AWGN:MODE CW

**System Bandwidth - AWGN** (Additive Noise and Noise Only) Sets the RF bandwidth to which the set carrier/noise ratio relates.

Within this frequency range, the signal is superimposed with a noise signal whose level corresponds exactly to the set C/N ratio.

---

**Note:**

*The noise signal is not generated arbitrarily for a particular bandwidth, but instead it is generated in steps. Noise therefore also occurs outside the set system bandwidth.*

---

Remote-control command:  
SOUR:AWGN:BWID 1.23 MHz

**Minimum Noise/System Bandwidth Ratio - AWGN** (Additive Noise and Noise Only) Sets the ratio of minimum noise bandwidth to system bandwidth.

The noise signal is not generated arbitrarily for a particular bandwidth, but instead it is generated in steps. Noise therefore also occurs outside the set system bandwidth.

With this parameter the minimum real noise bandwidth can be set as required by some standards. It does not influence the calculation of level from the set C/N ratio in relation to system bandwidth.

The overall bandwidth "System BW x Minimum Noise/System BW Ratio" may not exceed 80 MHz.

Remote-control command:  
SOUR:AWGN:BWID:RAT 2

**Noise Bandwidth - AWGN** (Additive Noise and Noise Only) Indicates the real noise bandwidth. The value is only indicated for **State On**.

---

**Note:**

*The noise signal is not generated arbitrarily for a particular bandwidth, but instead it is generated in steps. Noise therefore also occurs outside the set system bandwidth.*

---

Remote-control command:

SOUR:AWGN:BWID:NOIS?

**Target CW Frequency - AWGN** Sets the desired frequency of the sine in **CW Interferer** mode.

Remote-control command:

SOUR:AWGN:FREQ:TARG 3.4 MHz

**Resulting CW Frequency - AWGN** Indication of the actual CW frequency of the sinusoidal signal in **CW Interferer** mode. The actual frequency may differ from the desired frequency, since the resolution is limited to 0.7 Hz.

---

**Note:**

*The desired frequency constellation can be precisely set with an accuracy of up to 0.01 Hz by selecting a suitable frequency offset of the baseband source (e.g. Custom Dig Mod) and by correcting the RF frequency by the difference between Resulting and Target CW Frequency.*

---

Remote-control command:

SOUR:AWGN:FREQ:RES?

The interfering signal is configured in the **Noise Level Configuration** section.

**Set Noise Level via - AWGN** (Additive Noise only) Selects the mode for setting the noise level .

**C/N**

The noise level is set on the basis of the value entered for the carrier/noise ratio.

With digital modulation, the associated  $E_b/N_0$  value is determined and displayed

Remote-control command:

SOUR:AWGN:POW:MODE CN

 **$E_b/N_0$** 

The noise level is set on the basis of the value entered for the ratio of bit energy to noise power density.

The associated C/N value is displayed. The correlation between the two values is as follows:

$$\frac{C}{N} = \frac{E_b}{N_0} \cdot \frac{f_{bit}}{B_{sys}}$$

$f_{bit}$  = Bit rate (Symbol rate x Modulation value)

$B_{sys}$  = System bandwidth

With **Custom Dig Mod** signals, the bit rate used for calculation is defined by the selected standard in the **Custom Digital Mod** menu.

With **Digital Standard** signals, the bit rate to be used for calculating the  $E_b/N_0$  can be entered at **Bit Rate**.

Some test cases with the 3GPP base station tests (TS 25.141) specify, for example, E/N settings that apply to channel-coded data or block segments.

Remote-control command:

SOUR:AWGN:POW:MODE EN

**Reference Mode - AWGN**

(Additive Noise and CW Interferer) Select reference mode if the C/N or  $E_b/N_0$  ratio is changed.

**Carrier**

If the C/N value or  $E_b/N_0$  value changes, the carrier level is kept constant and the noise level is adjusted. This is the standard procedure for measuring the bit error rate versus the noise power.

Remote-control command:

SOUR:AWGN:POW:RMODE CARR

**Noise**

If the C/N value or  $E_b/N_0$  value changes, the noise level is kept constant and the carrier level is adjusted.

Some test cases of 3GPP Base Station Tests (TS 25.141) specify, for example, that the noise power be permanently set as a function of the base station power class, whereas the carrier power is variable.

Remote-control command:

SOUR:AWGN:POW:RMODE NOIS

**Bit Rate - AWGN**

(Additive Noise only) Sets or indicates the bit rate used for converting C/N to  $E_b/N_0$ .

**Custom Digital Mod:**

With **Custom Digital Mod** signals, the bit rate used is indicated here. It is defined by the choice of the standard in the **Custom Digital Mod** menu.

**Digital Standard:**

With **Digital Standard** signals, the bit rate used for converting C/N to  $E_b/N_0$  is set here.

When generating a **Digital Standard**, it is thus possible to select which bit rate is to be used for calculating the ratio of bit energy to noise power density, e.g. the bit rate before or after channel coding.

Remote-control command:

```
SOUR:AWGN:BRAT 3.4E6
```

**Carrier Noise Ratio - AWGN** (Additive Noise and CW Interferer only) Sets the carrier/noise ratio.

**Reference Mode Carrier**

This entry determines the RFI power in the **Reference Mode Carrier** and thus the power of the output signal. It does not affect the power of the useful signal, i.e. the carrier power remains constant.

**Reference Mode Noise**

This entry determines the power of the useful signal in the **Reference Mode Noise**, i.e. the carrier power. The RFI power remains constant.

The level of the noise signal which is derived from the entered C/N value is displayed in the menu under **Noise Level**. The value is displayed automatically in the units of the useful signal.

The level of the useful signal is displayed in the menu under **Carrier Level** and can also be changed there. The displayed value corresponds to the value in the **Level** display field.

The level of the output signal is displayed under **Carrier Level + Noise**.

If **Set Noise Level via  $E_b/N_0$**  is selected, the associated C/N value is displayed here.

Remote-control command:

```
SOUR:AWGN:CNR 10 dB
```



**Eb N0 - AWGN**

(Additive Noise only) Sets the ratio of bit energy to noise power density in **Additive Noise** mode.

**Reference Mode Carrier**

This entry determines for **Reference Mode Carrier** the noise level and therefore also the level of the output signal. It does not affect the level of the useful signal, i.e. the carrier level is kept constant.

**Reference Mode Noise**

This entry determines for **Reference Mode Noise** the level of the useful signal, i.e. the carrier level. the noise level is kept constant.

The level of the noise signal which is derived from the entered Eb/N0 value is displayed under **Noise Level**. The value is displayed automatically in the units of the useful signal.

The level of the useful signal is displayed in the menu under **Carrier Level**. The displayed value corresponds to the value in the **Level** display field.

The level of the output signal is displayed under **Carrier Level + Noise**.

If **Set Noise Level via C/N** is selected, the associated Eb/N<sub>0</sub> value is displayed here.

Remote-control command:

SOUR:AWGN:ENR 10 dB

**Carrier Level - AWGN****(Additive Noise and CW Interferer) Reference Mode Carrier**

Sets the carrier level for **Reference Mode Carrier**. This entry corresponds to the level entered in the **Level** header.

The level of the noise signal which is derived from the entered C/N value is displayed under **Noise Level**. The value is displayed automatically in the units of the useful signal.

**Reference Mode Noise**

Indicates the carrier level which is derived from the entered C/N value for **Reference Mode Noise**. This indication corresponds to the level indicated in the **Level** header.

The noise level can be set under **Noise Level**.

**Note:**

*The peak envelope power (PEP) specified in the header corresponds to the PEP value of the carrier. The PEP value of the overall signal is displayed in the menu under **Carrier +Noise PEP**.*

Remote-control command:

SOUR:AWGN:POW:CARR 10 dBm

**Noise Level (System Bandwidth) - AWGN**

**Noise Only mode:**

Sets the level of the noise signal.

In this mode, this entry corresponds to the level entered in the **Level** header.

**Additive Noise mode:**

**Reference Mode Noise**

Sets the level of the noise signal. The level of the carrier is derived from the entered C/N or Eb/N<sub>0</sub> value.

**Reference Mode Carrier**

Displays the level of the noise signal in the system bandwidth. The level of the noise signal is derived from the entered C/N or Eb/N<sub>0</sub> value. The carrier level is entered under **Carrier Level**.

**Note:**

*The noise signal is not generated arbitrarily for a particular bandwidth, but instead it is generated in steps. Noise therefore also occurs outside the set system bandwidth. This means that the total measurable noise level (see below) usually exceeds the value displayed here. Correct measurement of the noise level within the system bandwidth is possible by means of channel power measurement using a signal analyzer.*

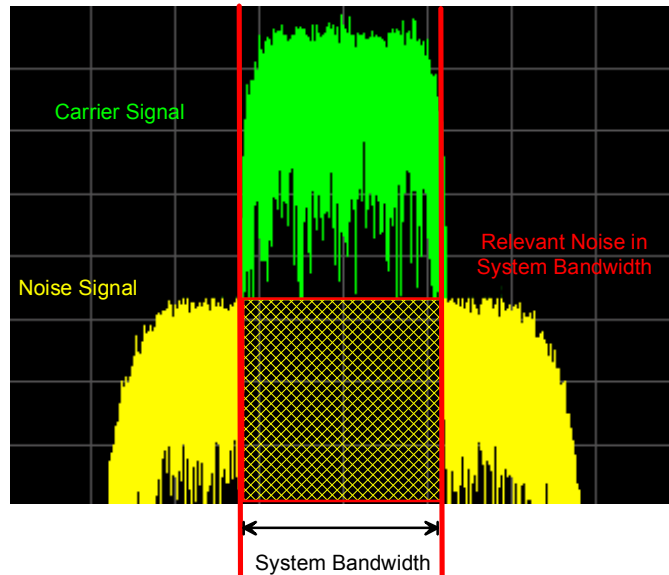

**Additive CW Interferer mode:**

**Reference Mode Noise**

Sets the level of the interfering signal. The level of the carrier is derived from the entered C/N value.

**Reference Mode Carrier**

Displays the level of the interfering signal. The level of the interfering signal is derived from the entered C/N value. The carrier level is entered under **Carrier Level**.

**Remote-control command:**

SOUR:AWGN:POW:NOIS 10 dBm

**Noise Level (Total Bandwidth) - AWGN**

Displays the level of the noise signal in the total bandwidth in **Noise Only** and **Additive Noise** mode:

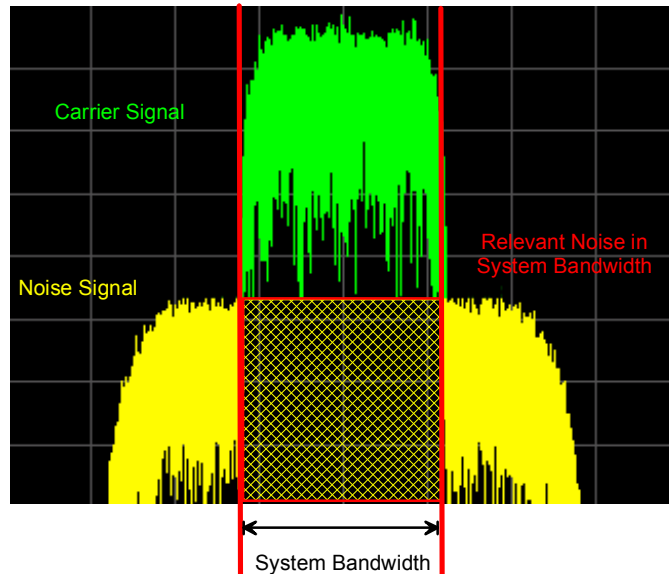

Remote-control command:

SOUR:AWGN:POW:NOIS:TOT?

Response: 19 dB

**Carrier + Noise Level - AWGN**

(Additive Noise and CW Interferer) Displays the overall level of the noise signal plus useful signal.

Remote-control command:

SOUR:AWGN:POW:SUM?

**Carrier + Noise PEP - AWGN**

(Additive Noise and CW Interferer) Displays the peak envelope power of the overall signal comprised of noise signal plus useful signal.

**Note:**

*The peak envelope power (PEP) specified in the header corresponds to the PEP value of the carrier.*

Remote-control command:

SOUR:AWGN:POW:SUM:PEP?

# Baseband Signal - Baseband

## Introduction - Baseband Signal

The R&S Vector Signal Generator provides you with the ability to generate digital modulation signals in accordance with the definitions in the digital standards or with user-definable characteristics. Signals are generated in realtime or from a data store with the aid of external and internal data. You can also load externally computed modulation signals into the R&S Vector Signal Generator in the form of waveform files.

Several digital standards are provided, plus digital modulation with user-definable signal characteristics, generation of waveforms with the aid of the Arbitrary Waveform Generator and generation of multicarrier CW signals with the aid of Multicarrier CW.

The settings for digital modulation can be accessed in the block diagram via the "**Baseband**" function block or with the aid of the **MENU** key.

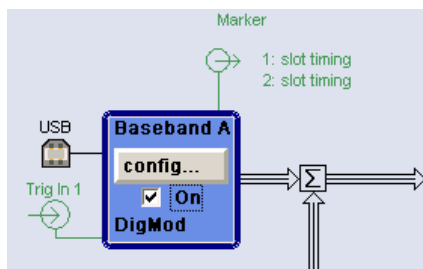

The equipment layout for generating the internal, digital modulation signals includes the options Baseband Main Module (B13) ) and one of the options Baseband Generator (B9/B10/B11) ). The three Baseband Generator options feature different ARB memory sizes (see data sheet). Apart from the memory size, however, the options offer the same functionality, either one can be installed.

In addition, the appropriate option is required for the digital standards. These options are specified in the description of the respective standard.

The minimum equipment for a two-path instrument is a second R&S SMATE-B9/B10/B11 option. This can be used simultaneously on the second path to generate a modulation signal which can either be routed via path A or added to the signal on path A with a frequency offset that can be set. In the case of a fully two-path layout (baseband and RF sections) path B can be operated as a second signal generator independently of path A (see chapter 2, '[Getting Started](#)', and data sheet).

In the subsequent signal route the baseband signals can be frequency-shifted, detuned or loaded with noise (see sections [Menu Impairment Settings](#)" and "[Noise generator - AWGN](#)").

# Signal Routing and Frequency Shifting

In the case of two-path instruments, signal routing, frequency offset and path gain definition are defined at the topmost menu level in the **Baseband** block or by using the **MENU** button under **Baseband**.

The upper part of the **Baseband** menu is used for selecting digital standards, digital modulation and waveform generation. These menus are described in the respective chapters relating to the modulation systems.

The lower part of the **Baseband** menu can be used to define a frequency offset a path gain, and the signal routing for two-path instruments.

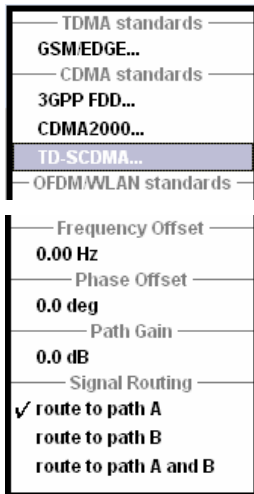

The upper part of the **Baseband** menu is used for selecting digital standards, digital modulation and waveform generation. These menus are described in the respective chapters relating to the modulation systems.

The **Frequency Offset** section is used to enter the frequency offset.

**Frequency Offset - Baseband**

Enters the frequency offset for the baseband signal.

The offset affects the signal on the **Baseband block** output. It shifts the useful baseband signal in the center frequency.

**Note:**

*It is not possible to enter a frequency offset if a waveform with a sample rate of exactly 100 MHz is introduced. A signal of this nature is not routed via the resampler in which the frequency shift takes place. This type of entry is also prohibited if the noise generator (AWGN block) is on.*

The complex I/Q bandwidth of the shifted useful signal must not exceed 80 MHz in total. The following applies:

$$f_{\text{offset}} - \frac{f_{\text{use}}}{2} \geq -\frac{80}{2} \text{ MHz} \quad \text{and} \quad f_{\text{offset}} + \frac{f_{\text{use}}}{2} \leq +\frac{80}{2} \text{ MHz}$$

$f_{\text{use}}$  = the complex useful bandwidth of the I/Q signal before the offset.

$f_{\text{offset}}$  = frequency offset.

The following graph illustrates the setting range for the frequency offset.

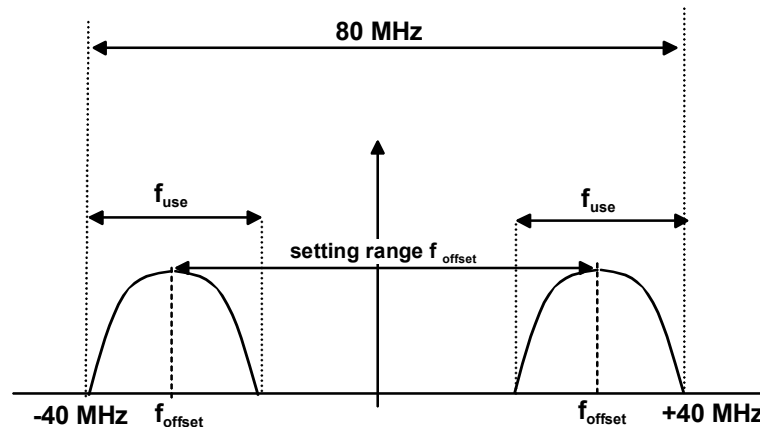
**Example:**

3GPP FDD signal (chip rate 3.84 Mcps, root-cosine filter 0.22).

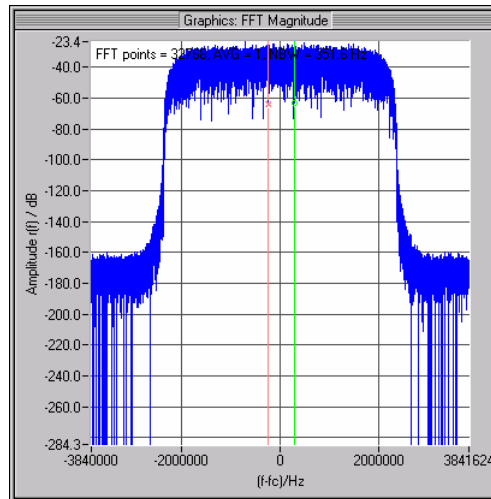

The complex useful bandwidth of a signal which has been filtered using a root-cosine filter with roll off  $\alpha$  is calculated as follows:

$$f_{use} = (1 + \alpha) * f_{symbol}$$

$f_{symbol}$  = the symbol rate or chip rate of the signal.

In the example the complex useful bandwidth is calculated as follows:

$$F_{use} = (1 + 0.22) * 3.84 \text{ MHz} = 4.6848 \text{ MHz.}$$

So as to comply with the condition requiring a maximum I/Q bandwidth of 40 MHz, the valid range of values for the frequency offset is then:

$$-40\text{MHz} + \frac{4.6848 \text{ MHz}}{2} \leq f_{offset} \leq 40\text{MHz} - \frac{4.6848 \text{ MHz}}{2} =$$

$$-35.3152\text{MHz} \leq f_{offset} \leq 35.3152\text{MHz}$$

In the case of ARB signals, the output clock rate can be used for estimating the maximum I/Q bandwidth of the waveform.

Remote-control command:

SOUR:BB:FOFF 2MHZ

The **Phase Offset** section is used to enter the relative path gain.

**Phase Offset - Baseband** Enters the phase offset for the baseband signal of the selected path compared to the baseband signal of the other path and/or of the external baseband input.

The gain affects the signal on the **Baseband block** output.

Remote-control command:  
SOUR:BB:POFF 0.4DEG

The **Path Gain** section is used to enter the relative path gain.

**Path Gain - Baseband** Enters the path gain for the baseband signal of the selected path compared to the baseband signal of the other path and/or of the external baseband input.

The gain affects the signal on the **Baseband block** output.

The **Path Gains** of the different baseband sources (Baseband Input, Baseband A and Baseband B) define the relative gain of the associated signals. The real gain depends on the following parameters along with the set path gain:

- Signal characteristics, in particular the crest factor
- Number of baseband sources
- Overall RF output level.

The sum baseband signal can be verified in the spectrum display in the **Graphics** block.

Remote-control command:  
SOUR:BB:PGA 2 dB

The **Signal Routing** section is used to define the signal route for two-path instruments.

**Signal Routing - Baseband** Selects the signal route for the baseband signal of a two-path instrument. The following table shows the combination of signal routes allowed for two-path instruments.

**Route to path A** The baseband signal is introduced into path A. The signals from both paths are summed if necessary.

Remote-control command:  
SOUR:BB:ROUT A

**Route to path B** The baseband signal is introduced into path B. The signals from both paths are summed if necessary.

Remote-control commands:  
SOUR:BB:ROUT B

**Route to path A and B** The baseband signal is introduced into path A and path B. The signals from both paths are summed if necessary.

Remote-control command:  
SOUR:BB:ROUT AB



Table 4-2 Combinations of signal routings for two-path instruments

Routing baseband A	Routing baseband B	Block diagram
Route to path A	Route to path A	
Route to path A	Route to path B	
Route to path A	Route to path A and B	
Route to path B	Route to path A	
Route to path B	Route to path B	
Route to path B	Route to path A and B	

Routing baseband A	Routing baseband B	Block diagram
Route to path A and B	Route to path A	
Route to path A and B	Route to path B	
Route to path A and B	Route to path A and B	

## Data and Signal Sources in Baseband

This section describes the common characteristics of the signals used for generating the baseband signal for all standards, including for example all listed data sources. The selection in the digital menus at any given time depends on the parameter and standard concerned and is clear from the selection list offered in the menu. The external data sources may therefore not be available in certain cases.

Characteristics which are uniquely specific to particular standards are described in relation to the menu concerned.

**Note:**

*Externally generated analog baseband signals can be fed into the digital signal path via the analog I/Q input **I IN** and **Q IN** (option Baseband Input, R&S SMATE-B17)*

The following input signals are used when digital modulation signals are being generated:

- Modulation data
- Clock signals
- Control signals

The input signals can be both internally generated and supplied from an external source. The internally generated data and clock signals are output not only on the DATA and Clock connectors but also on the corresponding pins of the AUX I/O interface.

In the case of two-path instruments the external data and clock sources are permanently allocated to path A, and data output is always for path A.

Likewise control signals and also trigger signals for triggering signal generation in the R&S Vector Signal Generator can be internally generated or supplied from an external source.

Up to four marker output signals for synchronizing external instruments can be user-defined for each path.

Externally computed waveform files can be loaded via one of the computer interfaces (USB - memory stick, or Ethernet interface - network drive) or via the IEC bus in the instrument and generated with the aid of the Arbitrary Waveform Generator (ARB, see section "[Arbitrary Waveform Generator ARB](#)", page 4.206). Internally the **Multicarrier CW** menu for defining multicarrier waveforms is available (see section "[Multicarrier Continuous Wave](#)", page 4.244).

## Internal PRBS Data and Data Patterns

PRBS generators deliver pseudo-random binary sequences of differing length and duration. They are known as maximum length sequences, and are generated with the aid of ring shift registers with feedback points determined by the polynomial.

By way of example, the diagram below shows a 9-bit generator with feedback to registers 4 and 0 (output).

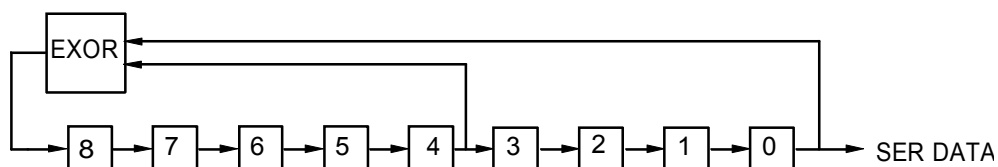

Fig. 4-3 9-bit PRBS generator

The pseudo-random sequence from a PRBS generator is uniquely defined by the register number and the feedback. The following table describes all the available PRBS generators:

Table 4-3 PRBS generators

PRBS generator	Length in bits	Feedback to	Menu selection
9-bit	$2^9 - 1 = 511$	Registers 4, 0	PRBS 9
11-bit	$2^{11} - 1 = 2047$	Registers 2, 0	PRBS 11
15-bit	$2^{15} - 1 = 32767$	Registers 1, 0	PRBS 15
16-bit	$2^{16} - 1 = 65535$	Registers 5, 3, 2, 0	PRBS 16
20-bit	$2^{20} - 1 = 1048575$	Registers 3, 0	PRBS 20
21-bit	$2^{21} - 1 = 2097151$	Registers 2, 0	PRBS 21
23-bit	$2^{23} - 1 = 8388607$	Registers 5, 0	PRBS 23

The **Data Source** selection for PRBS data from the menus is **PN09**, ....

Simple data patterns such as binary 0 strings or 1 strings can also be used as internal modulation data. The **Data Source** selection from the menus is **ALL 0**, **ALL1**. A variable bit string with a maximum length of 64 bits can be entered in an input field by selecting **Pattern**.

## Internal Modulation Data from Lists

Internal modulation data can be generated and stored in the form of binary lists. A separate file is created for each list and held on the R&S Vector Signal Generator hard disk. The file name can be defined by the user.

The **Data Source** selection from the menus is **Data List**. When this menu item is chosen the **Select Data List** button appears; this opens the file-selection window for data lists. A list can be created and edited in the **Data List Editor**, which is accessed from the menu via the **List Management** or **Data List Management** button.

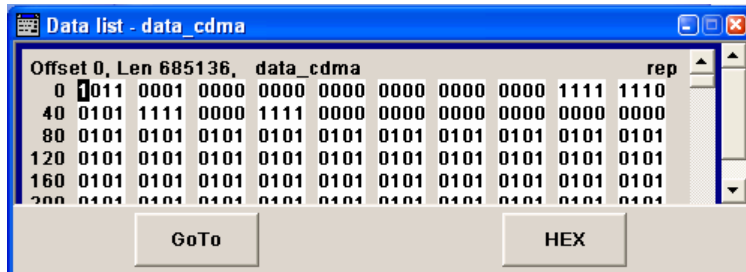

The maximum length of a data list is determined by the size of the data list memory (see data sheet). There is no restriction on the number of lists that can be stored.

## External Synchronous Modulation Data

### External Serial Modulation Data via the DATA Connector

For **Custom Digital Modulation**, serial modulation data can be supplied bit-by-bit via the DATA connector. The **Data Source** selection from the menu is **Extern Serial**. In the case of two-path instruments the DATA input is permanently allocated to path A.



In the case of modulation modes with more than 1 bit/symbol, the most significant bit (MSB) must be fed in first (MSB first).

The clock reference (symbol clock) used to read in the data can be either internal or external.

External serial data is output on the PARDATA pins of the AUX I/O interface as parallel data LSB-justified.

The maximum data rate for serial data processing can be found in the data sheet.

### External Parallel Modulation Data via the AUX I/O Interface

For **Custom Digital Modulation**, parallel data can be supplied symbol-by-symbol via the AUX I/O interface (D0 – D9). The **Data Source** selection from the menu is **Extern Parallel**. In the case of two-path instruments the data lines from the AUX I/O interface are permanently allocated to path A.

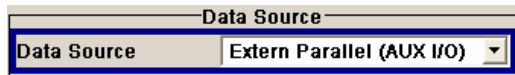

In the case of modulation modes with fewer than 10 bits/symbol, the data must be applied LSB-justified. In the case of 8-PSK modulation for example (3 bits/symbol) only data lines D0, D1 and D2 are used.

The clock reference (symbol clock) used to read in the data can be either internal or external.

External parallel data is output on the DATA connector serially. However, there is a maximum data rate above which serial data processing becomes impossible and the DATA connector becomes high-impedance. The maximum data rate for parallel data processing is shown in the data sheet.

## External Asynchronous Modulation Data

Asynchronous data can be supplied via the USB interface as a data source for **Custom Digital Modulation** and the digital standards. The **Data Source** selection from the menu is **Ext USB**.

In the case of two-path instruments the USB interface is permanently allocated to path A.



Data processing in path A can be synchronized with the internal clock reference or an external symbol clock or a multiple of these.

## Clock Signals

The clock reference used for generating the timing pulse can be either internal or external (**Clock Source** selection from the menu: **Internal / External**).

### Internal clock reference



When the internal clock reference is selected, the clock signals generated by the R&S Vector Signal Generator are output on the following connectors:

CLOCK (front panel)	Bit clock
CLOCK OUT (rear panel)	Choice of bit clock or symbol clock
BITCLK (AUX I/O interface, rear panel)	Bit clock
SYMBCLK (AUX I/O interface, rear panel)	Symbol clock

If required, in the case of two-path instruments the internal bit clock or symbol clock from path B can be output on one of the USER interfaces. The clock output signals are assigned in the menu sequence **Setup - Environment - Global Trigger/Clock/External Inputs - USER Marker /AUX I/O Settings**.

### External clock reference



When the external clock reference is selected, it is always supplied via the CLOCK connector on the front panel. The internal clocks synchronized to it are output on the following connectors:

CLOCK OUT (rear panel)	Choice of bit clock or symbol clock
BITCLK (AUX I/O interface, rear panel)	Bit clock
SYMBCLK (AUX I/O interface, rear panel)	Symbol clock

The active edge of the external clock signal on the CLOCK input is selectable (menu Setup-**System-Global Trigger/Clock/External Inputs**). Internally the rising edge is always taken as the active edge. The active rising edge of the internal clocks is therefore synchronized with either the rising or the falling edge of the external clock reference. A symbol clock can be supplied externally or, if internally generated or externally asynchronous data is being fed in, a multiple of a symbol clock can be supplied.

In the case of two-path instruments the external clock signal is applied to path A.

In order for the clock synthesizer on the R&S Vector Signal Generator to be synchronized correctly, the external clock reference must first be applied and the correct symbol rate must then be set. Until this has been done the external clock source must not be selected (**Clock Source External**).

---

**Note:**

*The symbol rate set must not deviate from the symbol rate of the external signal by more than 2% (see also data sheet).*

---

The synchronization of data signals and clock signals for the various data sources and clock sources is described in the following section.

## Synchronizing Data Signals and Clock Signals

When selecting data signals and clock signals, the following operating modes are possible:

- Internal clock and internal data
- Internal clock and external synchronous data
- External clock and external synchronous data
- External clock and either internal data or external asynchronous data (via USB interface)

### Internal Clock and Internal Data

When internal data is selected for path A, this data is output in serial mode on the DATA connector or in parallel mode on the PARADATA pins of the AUX I/O interface (**Custom Digital Modulation**).

In modulation modes with fewer than 10 bits/symbol, the parallel data is output LSB-justified. In the case of 8-PSK modulation for example (3 bits/symbol) only data lines D0, D1 and D2 are used.

The internal data of path B is not output in the case of two-path instruments. For synchronization purposes, however, it is possible to output the bit clock or symbol clock from this path to one of the USER connectors.

The following diagram shows by way of example the output signals on the serial DATA interface in the case of 8-PSK modulation (3 bits per symbol). The positive edge of the clock is always used when outputting data. The data source is a data list with 15 bits = 001 010 100 101 110 (5 symbols).

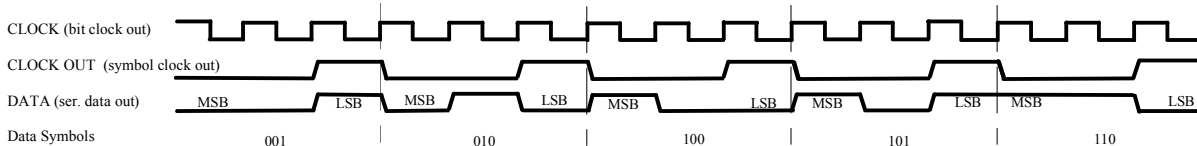

Fig. 4-4 Output signal on the serial data interface and clock output signals on the AUX I/O interface

There is a maximum data rate above which serial data processing becomes impossible. This data rate can be found in the data sheet. If the rate is exceeded the DATA connector becomes high-impedance, and the output on the CLOCK connector is the symbol clock instead of the bit clock.

The following diagram shows by way of example the output signals on the parallel interface in the case of 8-PSK modulation (3 bits per symbol). The data source is a data list with 15 bits = 001 010 100 101 110 (5 symbols).

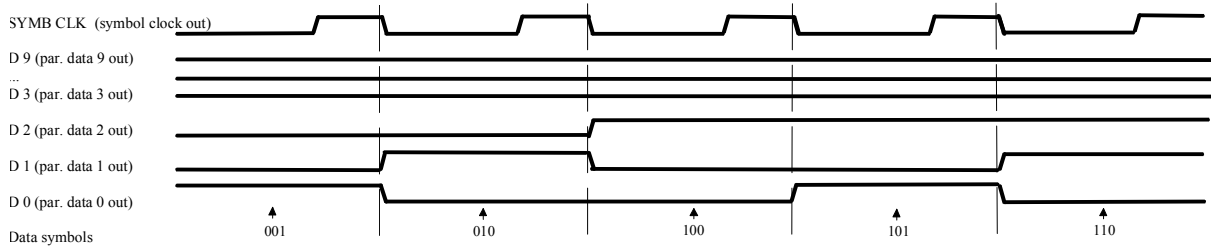

Fig. 4-5 Data and clock output signals on the parallel AUX I/O interface

In order for parallel external data to be retrieved correctly the rising edge of the symbol clock must be used, since the timing between the falling edge of the symbol clock and the data switch on the parallel interface is undefined.

**Internal Clock and External Synchronous Data**

**External serial data**

When serial data for **Custom Digital Modulation** is being fed in via the DATA connector on the front panel, the symbol clock acts as a scanning pulse (strobe) so as to mark the least significant bit in a symbol.

The clock signals are output on the CLOCK and CLOCK OUT connectors (front panel and rear panel respectively, choice of bit clock or symbol clock on the latter) and on the BITCLK or SYMBCLK pins on the AUX I/O interface. Optimum timing is achieved from using the output signal on the CLOCK connector on the front panel. The setup and hold times (see following diagram,  $t_{setup}$  and  $t_{hold}$ ) that must be maintained in the R&S Vector Signal Generator to ensure that the serial data is accepted correctly can be found in the data sheet.

The following diagram illustrates the timing ratios between data and clock when serial data is being supplied from an external source and the internal clock source is being used.

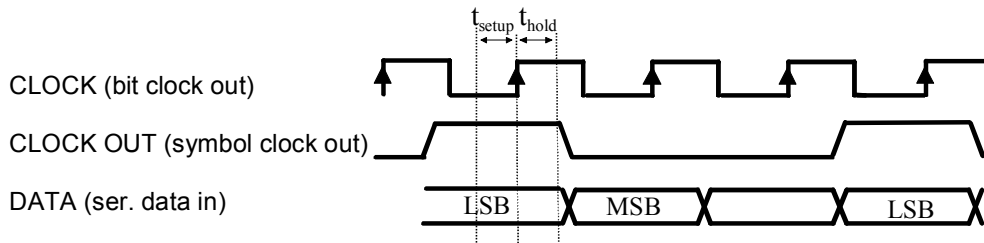

Fig. 4-6 External serial data and the clock signals which are output (bit clock and symbol clock). The setup time ( $t_{setup}$ ) and hold time ( $t_{hold}$ ) can be found in the data sheet.



### External parallel data

When parallel data for **Custom Digital Modulation** is being fed in via the AUX I/O interface (D0 – D9), the internal symbol clock is used.

The symbol clock is output on the CLOCK OUT connector (rear panel, choice of bit clock or symbol clock) and on the SYMBCLK pin on the AUX I/O interface. Optimum timing is achieved by using the symbol clock on the SYMBCLK pin on the AUX I/O interface. The setup and hold times (see following diagram,  $t_{\text{setup}}$  and  $t_{\text{hold}}$ ) that must be maintained in the R&S Vector Signal Generator to ensure that the serial data is accepted correctly can be found in the data sheet.

The following diagram illustrates the timing ratios between data and clock when parallel data is being supplied from an external source and the internal clock source is being used.

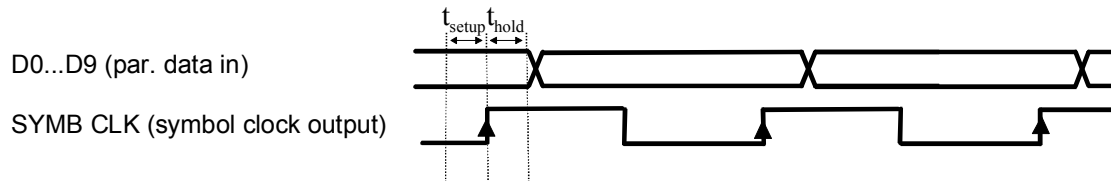

Fig. 4-7 External parallel data, internal clock signal and the clock signal that is output on the AUX I/O interface. The setup time ( $t_{\text{setup}}$ ) and hold time ( $t_{\text{hold}}$ ) can be found in the data sheet.

### External Clock and External Synchronous Data

When synchronous modulation data is being fed in from an external source for **Custom Digital Modulation**, clock generation in the R&S Vector Signal Generator can be synchronized on the rising or falling edge of an external symbol clock. The clock reference is supplied on the CLOCK connector (front panel).

The clock signals generated as a result are output on the CLOCK OUT connector (rear panel, choice of bit clock or symbol clock) and on the BITCLK or SYMBCLK pins on the AUX I/O interface.

### External serial data

The following diagram illustrates the timing ratios between data and clock when serial data is being supplied from an external source and an external reference clock is being used.

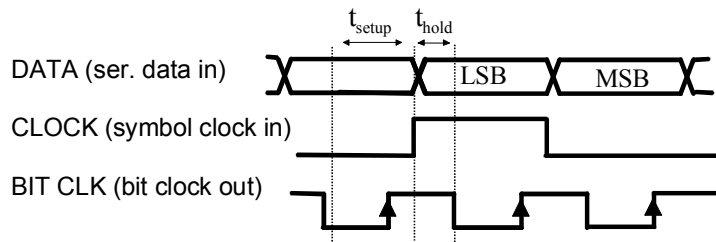

Fig. 4-8 External serial data and external symbol clock - 3 bits/symbol with high and low active **symbol clock** for marking the LSB. The data and the symbol clock must change state simultaneously. The setup time ( $t_{\text{setup}}$ ) and hold time ( $t_{\text{hold}}$ ) can be found in the data sheet.

A bit clock is generated from the externally supplied symbol clock and is used for reading the serial data into the R&S Vector Signal Generator. The active edge of this bit clock is located ahead of the symbol clock.

**External parallel data**

The following diagram illustrates the timing ratios between data and clock when parallel data is being supplied from an external source and an external reference clock is being used.

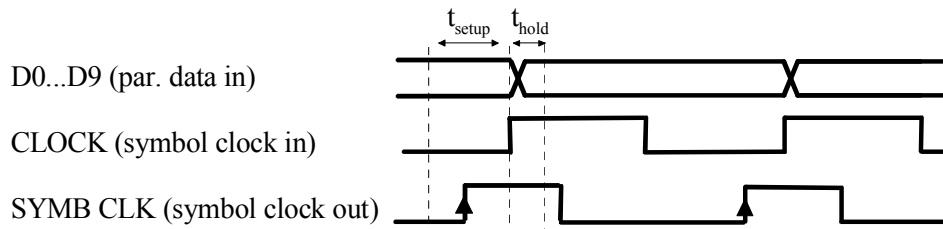

Fig. 4-9 External parallel data with high and low active external symbol clock. The setup time ( $t_{\text{setup}}$ ) and hold time ( $t_{\text{hold}}$ ) can be found in the data sheet.

The R&S Vector Signal Generator uses the externally supplied symbol clock to generate an internal symbol clock that defines the sampling points at which the parallel data is read into the R&S Vector Signal Generator. These sampling points are also located a little ahead of the external symbol clock.

**External Clock and Internal or External Asynchronous Data**

If the modulation data is internally generated or supplied asynchronously from an external source, clock generation in the R&S Vector Signal Generator can be synchronized on an external symbol clock, or a multiple thereof, which is fed in on the CLOCK connector (front panel). Synchronization can be based on the rising edge or falling edge according to choice. The maximum permissible multiple symbol clock can be found in the data sheet.

## Control Signals

The following control signals are processed in the R&S Vector Signal Generator:

- **Burst Gate** and **Level Attenuation** for power ramping
- **CW** for controlling the CW (continuous wave) mode. The **CW** signal turns off digital modulation. The RF signal is output in unmodulated form. In the case of standards in which it is possible to switch between different modulation modes, the signal only is output and cannot be supplied from an external source. In such cases it indicates the modulation mode internally (standard GSM: signal high (1) = modulation mode GMSK and signal low (0) = modulation mode 8PSK EDGE).

The CW control signal is generated internally or supplied externally via the AUX I/O interface. The control signals for power ramping can be provided externally for **Custom Digital Modulation** only. When generated internally the signals are output on the AUX I/O interface.

A dedicated internal **Control Data Editor** is provided for defining the control signals. This editor with its intuitive graphical interface can be used to define and save control signals. Definition by generating or editing a binary list is no longer necessary (though it is still possible via the IEC bus).

A separate file with the file extension **\*.dm\_iqc** is created for each defined control signal and held on the R&S Vector Signal Generator hard disk.

If the **Component Data Editor** is used, the **Control Data Editor** is integrated with it. The defined control data is not held separately, but stored with the data structure. This applies both to signals of the Data Editor Realtime and the Data Editor Offline.

### Power Ramping and Level Attenuation

In TDMA radio networks it is necessary to control the RF output signal envelope synchronously for the purpose of digital modulation. The signals BURST\_GATE and LEV\_ATT are used for this. These signals are internally generated. In the case of **Custom Digital Modulation** they can also be supplied from an external source via the AUX I/O interface.

When power ramping is enabled, a ramp is generated whenever there is a data switch on the **Burst** signal (from high to low or low to high). The steepness of this ramp can be adjusted. Power ramping is enabled and configured in the **Power Ramp Control** submenu.

The **Lev\_Att** signal is used to control a defined level attenuation. If level attenuation is enabled, the modulation signal level is attenuated by a defined value if the **Lev\_Att** signal is high. The level attenuation value is defined in the **Power Ramp Control** menu. For the **GSM/EDGE** standard a maximum of 7 different level attenuation values can be defined and allocated separately to the 8 slots quite independently of one another. Level attenuation is enabled either in the **Power Ramp Control** menu (Custom Digital Modulation) or in the Burst Editor (GSM/EDGE).

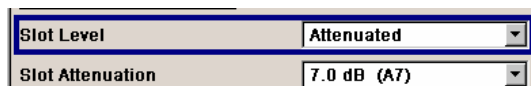

Level attenuation makes it possible to simulate radio stations located at various distances.

The diagram below shows an example of how the power ramping signals work.

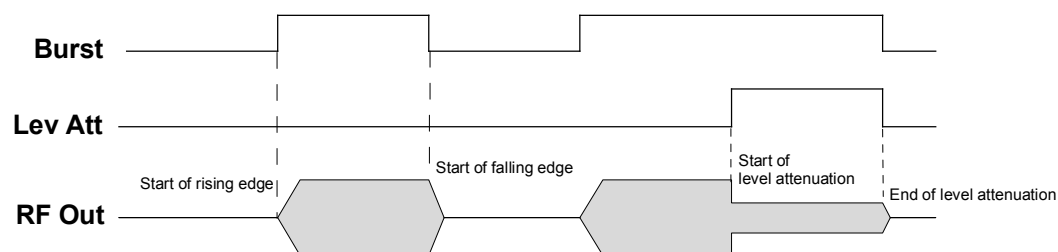

Fig. 4-10 Signal behavior when power ramping is enabled. The **Burst Gate** signal defines the start of the rising and falling edges of the envelope, and the **Lev\_Att** signal defines the start and end of level attenuation. The level attenuation value is defined in the **Power Ramp Control** menu.

## Trigger Signals

In the R&S Vector Signal Generator, trigger signals are internally generated or externally supplied signals which start signal generation at a particular point in time.

Signal generation can also take place without triggering, in which case the signal is then generated in full after modulation is powered up. A trigger event either has no effect on signal generation (menu setting **Trigger Mode Auto**) or triggers a signal restart (menu setting **Trigger Mode Retrigger**).

If signal generation is triggered, the signal is continuously generated after the first trigger. In the **Armed\_Auto** mode, a further trigger event has no effect. In the **Armed\_Retrig** mode, every additional trigger event triggers a restart of the signal. In both cases, triggering can be reset to the initial state (**armed**), i.e. signal generation is stopped and the instrument waits for the next trigger to start signal generation anew.

The status of signal generation (**Running** or **Stopped**) is displayed for all trigger modes in the corresponding trigger menu of the digital standard currently switched on. The signal generation status particularly with an external trigger can thus be checked.

Internal and external trigger sources are available for triggering.

- Internally, triggering is carried out manually by pressing the **Execute Trigger** button (menu selection **Internal**).
- In the case of two-path instruments, internal triggering can be caused by the trigger signal on the second path (menu selection **Internal (Baseband A/B)**). This makes it possible to synchronize the signal on one of the two paths with the signal on the second path. As in the case of external triggering, it is possible to set the trigger signal to be delayed or suppressed.

- External trigger signals can be fed in via the TRIGGER 1 and 2 connectors on the front and rear panels (menu selection **External**).

In the case of external triggering and internal triggering by the trigger signal on the second path, the start can be delayed by a definable number of symbols (menu setting (**External**) **Trigger Delay**). This makes it possible to purposely simulate the time delay between a base station signal and a user equipment signal, for example in the course of base station tests.

The effect of a restarted trigger signal in the **Retrigger** trigger mode can be suppressed for a definable number of symbols (menu setting (**External**) **Trigger Inhibit**). By this means the trigger can be suppressed for a definable number of frames, for example in the course of base station tests, and yet the signal can still be generated synchronously. In each frame the base station generates a trigger which would cause a signal generation restart every time but for the suppression.

**Example:** Entering 1000 samples means that after a trigger event, any subsequent trigger signal is ignored for the space of 1000 samples.

A signal which marks the trigger event set off by the current internal or external trigger of path A or B can be output at the USER connectors (AUX IO interface or USER BNC connector).

---

**Note:**

*The trigger mode setting, the selection of the trigger source and the setting of a delay and trigger suppression in the case of external triggering are carried out independently for each of the two paths. On the other hand configuration of the trigger connectors (polarity and impedance) is carried out jointly for both paths.*

---

## Marker Output Signals

The R&S Vector Signal Generator generates user-definable marker output signals which can be used to synchronize external instruments. By this means a slot clock or frame clock can be set, for instance, or the start of a particular modulation symbol can be marked.

Four marker outputs are available for each path. The outputs for markers 1 to 3 are defined, but marker 4 can be placed on one of the USER outputs according to choice.

### Path A

Markers 1/2	MARKER 1 / 2 BNC connectors on the front panel
Marker 3	MARKER 3 pin of the AUX I/O connector on the rear panel
Marker 4	USER1 BNC connector or USER2/3/4 pins of the AUX I/O connector on the rear panel according to choice

### Path B

Marker 1	MARKER 1B BNC connector on the rear panel
Markers 2/3	MARKER 2B / 3B pins of the AUX I/O connector on the rear panel
Marker 4	USER1 BNC connector or USER2/3/4 pins of the AUX I/O connector on the rear panel according to choice

# Digital Modulation - Custom Digital Modulation

## Introduction - Custom Digital Modulation

The R&S Vector Signal Generator can generate digital modulation signals with user-definable characteristics. Baseband filtering and the symbol rate can be set within wide limits.

The equipment layout for generating the digital modulation signals includes the options Baseband Main Module (B13) and Baseband Generator (B10/B11).

In the case of two-path instruments, at least one further Baseband Generator (B10/B11) option is needed for signal generation in the second path. Using this option a signal can be defined in path B and then either routed via path A or added to the signal on path A with a frequency offset that can be set. When path B is fully expanded with a second option Baseband Main Module (B13) and an RF section frequency option (B20x) the modulation signal can be output on RF output B.

When modulation is ON, a two-part level indication is shown in the header section of the display. This displays both the average power (LEVEL) and the peak envelope power (PEP) of the modulated RF output signal.



The difference between PEP and LEVEL depends on the modulation type and the filtering: Both values are pre-measured internally so that the displayed values match the true values in the signal. When external signals are used, they are replaced by PRBS data during pre-measurement.

## Modulation Types - Custom Digital Mod

The available modulation types are ASK (amplitude shift keying), FSK (frequency shift keying), PSK (phase shift keying) and QAM (quadrature amplitude modulation).

The actual modulation procedure is described by mapping, which assigns I and Q values (PSK and QAM) or frequency shifts (FSK) to every modulation symbol that occurs. This is represented graphically in the constellation diagrams.

The mapping for the selected modulation type is displayed in the **More...** submenu in the **Modulation** menu section (see "[More - Modulation Type - Digital Modulation](#)", page 4.181)

The QAM procedures 16QAM, 32QAM, 64QAM have been produced in accordance with ETSI standard ETS 300429 for digital video broadcasting (DVB). The QAM procedures 256QAM and 1024QAM are not specified in this standard, but have been produced according to the same basic principles.

In the case of all FSK procedures, the user can set the symbol rate  $f_{\text{SYMB}}$  up to a maximum value (see data sheet). If MSK is selected, the frequency deviation (**FSK deviation**) cannot be set since it is permanently set to  $\frac{1}{4}$  of the symbol rate.

Table 4-4 Modulation type and associated mapping

**PSK**

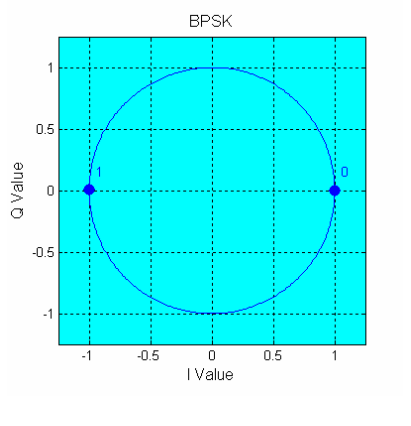
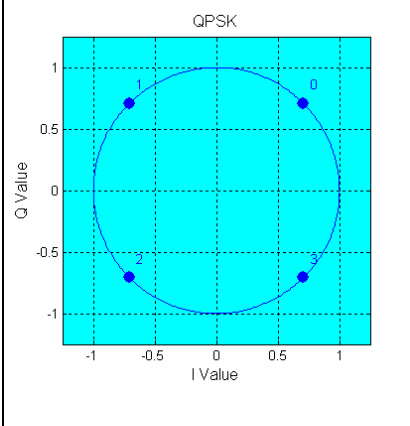
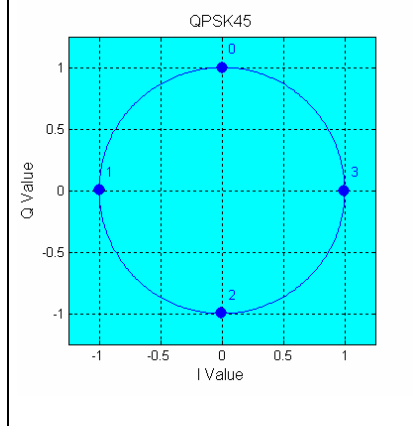
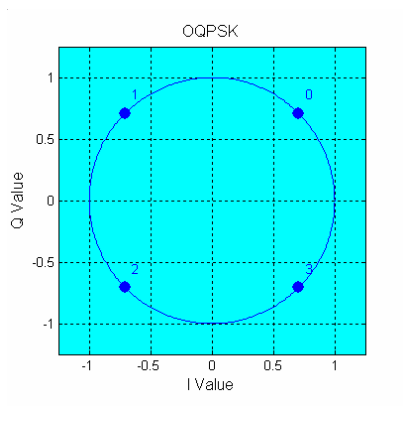
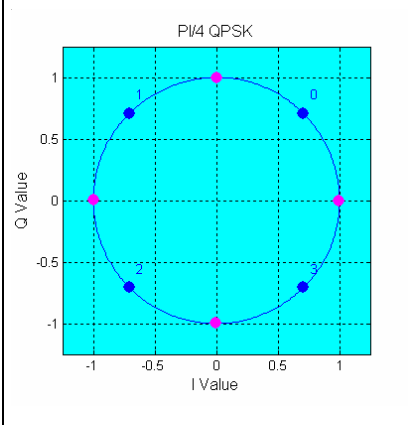
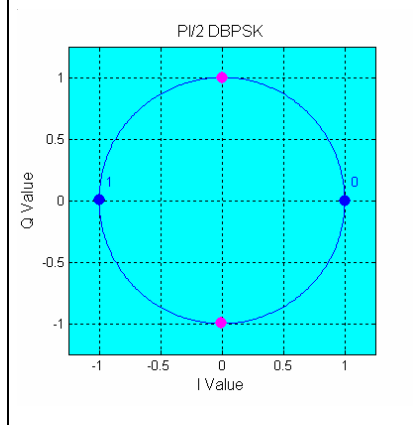
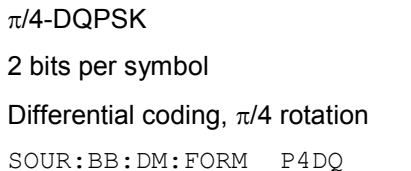
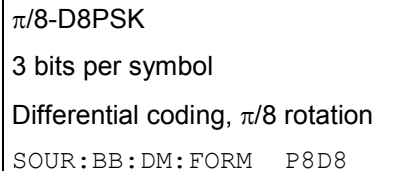
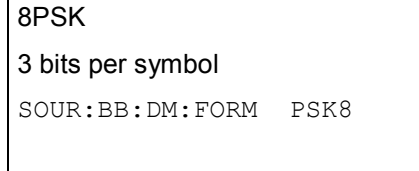
<p><b>BPSK</b> 1 bit per symbol SOUR:BB:DM:FORM BPSK</p>  <p>The diagram shows a circle on a grid with I Value on the x-axis and Q Value on the y-axis. Two points are marked: '1' at (-1, 0) and '0' at (1, 0).</p>	<p><b>QPSK</b> 2 bits per symbol SOUR:BB:DM:FORM QPSK</p>  <p>The diagram shows a circle with four points marked: '1' at (-0.707, 0.707), '0' at (0.707, 0.707), '2' at (-0.707, -0.707), and '3' at (0.707, -0.707).</p>	<p><b>QPSK 45° Offset</b> 2 bits per symbol 45° rotation SOUR:BB:DM:FORM QPSK45</p>  <p>The diagram shows a circle with four points marked: '0' at (0, 1), '1' at (-1, 0), '2' at (0, -1), and '3' at (1, 0).</p>
<p><b>OQPSK</b> 3 bits per symbol Q offset SOUR:BB:DM:FORM OQPSK</p>  <p>The diagram shows a circle with four points marked: '1' at (-0.707, 0.707), '0' at (0.707, 0.707), '2' at (-0.707, -0.707), and '3' at (0.707, -0.707).</p>	<p><b><math>\pi/4</math>-QPSK</b> 2 bits per symbol <math>\pi/4</math> rotation SOUR:BB:DM:FORM P4QP</p>  <p>The diagram shows a circle with eight points marked: '1' at (-0.707, 0.707), '0' at (0.707, 0.707), '2' at (-0.707, -0.707), '3' at (0.707, -0.707), and four additional points at 135, 225, 315, and 45 degrees.</p>	<p><b><math>\pi/2</math>-DBPSK</b> 1 bit per symbol Differential coding, <math>\pi/2</math> rotation SOUR:BB:DM:FORM P2DB</p>  <p>The diagram shows a circle with four points marked: '1' at (-1, 0), '0' at (1, 0), and two additional points at (0, 1) and (0, -1).</p>
<p><b><math>\pi/4</math>-DQPSK</b> 2 bits per symbol Differential coding, <math>\pi/4</math> rotation SOUR:BB:DM:FORM P4DQ</p>  <p>The diagram shows a circle with eight points marked: '1' at (-0.707, 0.707), '0' at (0.707, 0.707), '2' at (-0.707, -0.707), '3' at (0.707, -0.707), and four additional points at 135, 225, 315, and 45 degrees.</p>	<p><b><math>\pi/8</math>-D8PSK</b> 3 bits per symbol Differential coding, <math>\pi/8</math> rotation SOUR:BB:DM:FORM P8D8</p>  <p>The diagram shows a circle with sixteen points marked: '1' at (-0.98, 0.17), '0' at (0.98, 0.17), '2' at (-0.98, -0.17), '3' at (0.98, -0.17), and twelve additional points at 22.5 degree intervals.</p>	<p><b>8PSK</b> 3 bits per symbol SOUR:BB:DM:FORM PSK8</p>  <p>The diagram shows a circle with eight points marked: '1' at (-0.98, 0.17), '0' at (0.98, 0.17), '2' at (-0.98, -0.17), '3' at (0.98, -0.17), and four additional points at 45, 135, 225, and 315 degrees.</p>

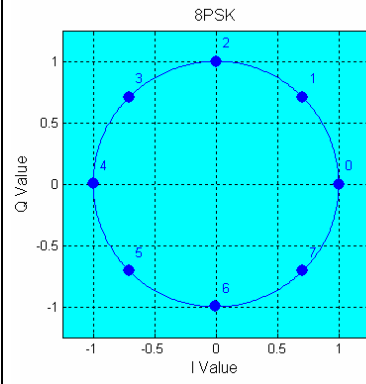
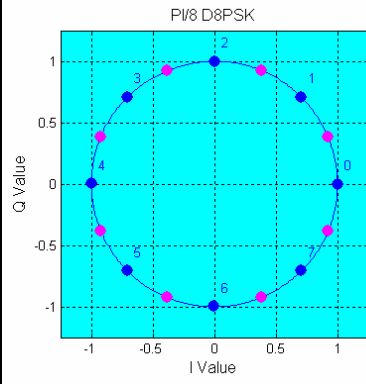
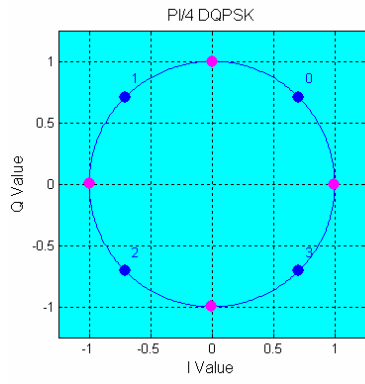

8PSK EDGE ( $3\pi/8$  8PSK)

3 bits per symbol

Edge coding,  $3\pi/8$  rotation

SOUR:BB:DM:FORM P8ED

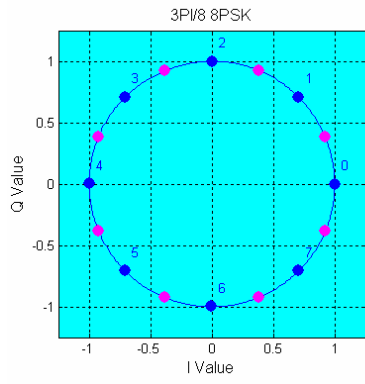



QAM

16QAM

4 bits per symbol

SOUR:BB:DM:FORM QAM16

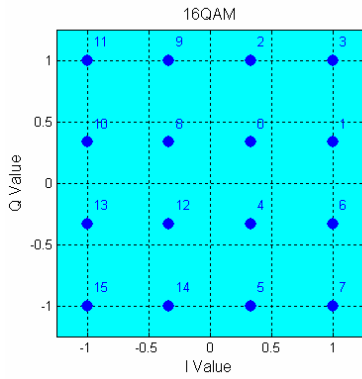

32QAM

5 bits per symbol

SOUR:BB:DM:FORM QAM32

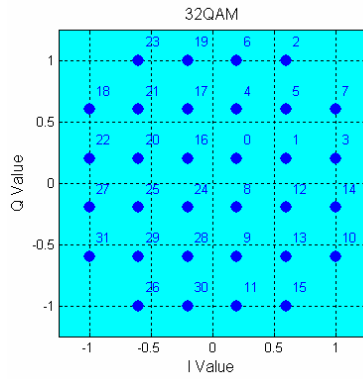

64QAM

6 bits per symbol

SOUR:BB:DM:FORM QAM64

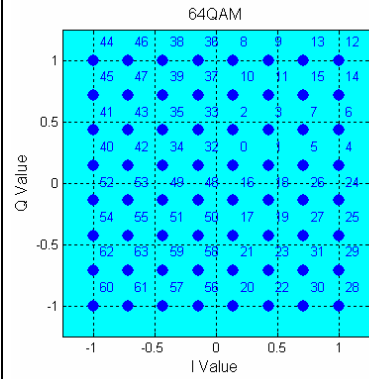

256QAM

8 bits per symbol

SOUR:BB:DM:FORM QAM256

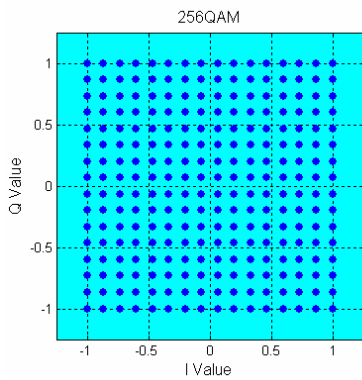

1024QAM

10 bits per symbol

SOUR:BB:DM:FORM QAM1024

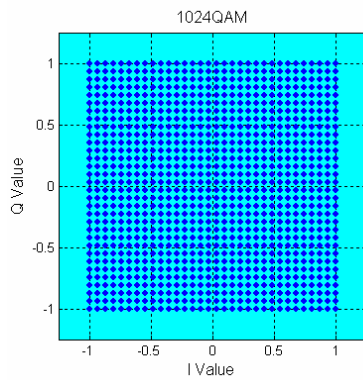

**FSK**

**Note:**

In addition to the following FSK modulations, a variable FSK modulation with definable deviation per symbol is available.

**MSK**

1 bit per symbol

FSK deviation

```
SOUR:BB:DM:FORM MSK
SOUR:BB:DM:FSK:DEV 0.1
MHz
```

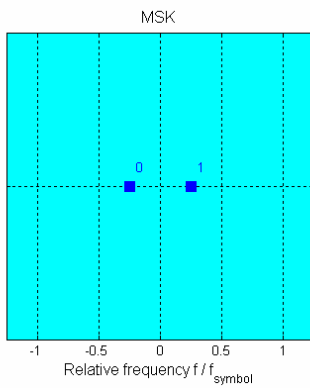

**2FSK**

1 bit per symbol

```
SOUR:BB:DM:FORM FSK2
```

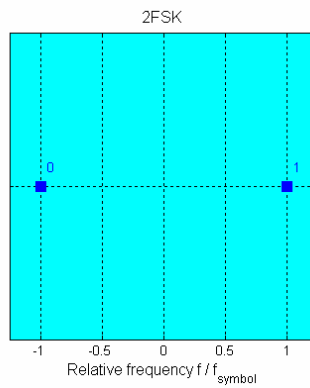

**4FSK**

2 bits per symbol

```
SOUR:BB:DM:FORM FSK4
```

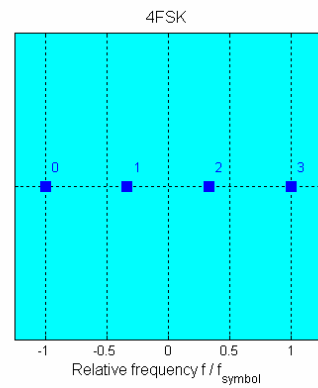

## Coding - Custom Digital Mod

Modulation symbols are coded directly before I and Q values or frequency shifts are assigned. Coding is thus directly related to modulation methods, which is the reason why codings are not freely combinable with modulation methods. The following table shows which of the coding combinations are available and defines the modulation types for which the various coding procedures can be used.

In the notation used below  $a_n$  denotes the n-th input symbol and  $b_n$  denotes the correspondingly coded output symbol. Individual bits in the symbols from the LSB (least significant bit) to the MSB (most significant bit) are denoted by  $a_{0n}$ ,  $a_{1n}$  and so on. The same applies to the output symbols.

Table 4-5 Permissible coding combinations for modulation symbols and modulation type

	OFF	Differ- ence	Phase differ- ence	Differ- ence + Gray	Gray	GSM	NADC, PDC, PHS, TETRA, APCO25 (PSK), PWT	TFTS/ TETRA	INMARSAT, ICO, WCDMA 3GPP, cdma2000	VDL	APCO25 (FSK)
ASK	X	X		X	X						
BPSK	X	X		X	X						
$\pi/2$ DBPSK	X				X						
QPSK	X	X		X	X				X		
QPSK 45° Offset	X	X		X	X				X		
$\pi/4$ QPSK	X	X			X						
$\pi/4$ DQPSK	X				X		X	X			
8PSK	X	X		X	X					X	
8PSK_EDGE	X										
$\pi/8$ D8PSK	X				X						
MSK	X	X		X	X	X					
2FSK	X	X		X	X	X					
4FSK	X	X		X	X						X
16QAM	X	X	X	X	X						
32QAM	X	X	X	X	X						
64QAM	X	X	X	X	X						
256QAM	X	X	X	X	X						
1024QAM	X	X	X	X	X						

### Modulation type $\pi/4$ DQPSK

With differential coding switched on at the same time, a constellation diagram is obtained for  $\pi/4$ DQPSK which is similar to that obtained for 8PSK. Phase shifts are however assigned to the individual modulation symbols. The following tables show the assignment of modulation symbols to phase shifts of the I/Q vector in relation to the selected coding.

Table 4-6 Phase shifts for  $\pi/4$ DQPSK

Modulation symbol $a_n$ (binary indication: MSB, LSB)	00	01	10	11
Phase shifts without coding	+ 45°	+135°	- 135°	-45°
Phase shifts with coding NADC, PDC, PHS, TETRA or APCO25 (PSK)	+ 45°	+135°	-45°	- 135°
Phase shifts with coding TFTS	- 135°	+135°	-45°	+ 45°

**Coding algorithms**

Common coding types are listed in the following table.

Table 4-7 Coding algorithms

Coding	Coding algorithm	Applicable for K bit/symbol
NONE	$b_n = a_n$	$k = 1...8$
Differential	$b_n = (a_n + b_{n-1}) \text{ modulo } 2^k$	$k = 1...7$
Differential + Gray	Gray coding with additional differential coding	$k = 1...7$
GSM	$dc_n = \text{not}(d_n \text{ exor } d_{n-1})$	$k = 1$

**Example 1:** Differential coding for QPSK modulation with  $K = 2$  bit/symbol

Decimal display; value range for modulation symbols

$$a_n \in \{0; 1; 2; 3\}$$

Recursive coding is defined as follows:  $b_n = (a_n + b_{n-1}) \text{ modulo } 4$ .

Depending on the state of a preceding modulation symbol  $b_{n-1}$  the coded modulation symbol  $b_n$  is obtained for example from modulation symbol  $a_n = 2$  as follows:

$a_n = 2$	$b_{n-1}$	$b_n$
	0	2
	1	3
	2	0
	3	1

By means of differential coding, the assignment between modulation symbols and phase differences shown in the following table is generated:

Modulation symbol $a_n$ (binary, MSB, LSB)	00	01	10	11
Phase difference	$0^\circ$	$90^\circ$	$180^\circ$	$270^\circ$

**Example 2:** Gray and differential coding for 8PSK modulation

First, a gray coding is performed according to the gray code. Afterwards, a differential coding is performed according to the recursive coding algorithm quoted above. The assignment between modulation symbols and phase differences shown in the following table is generated:

Modulation symbol $a_n$ (binary, MSB, LSB)	000	001	010	011	100	101	110	111
Phase difference	$0^\circ$	$45^\circ$	$135^\circ$	$90^\circ$	$270^\circ$	$315^\circ$	$225^\circ$	$180^\circ$

Differential coding according to VDL can be used for modulation types with 3 bits/symbol, e.g. 8PSK.

Table 4-8 Differential coding according to VDL

Modulation symbol (binary, MSB, LSB)	$d_n$	000	001	010	011	100	101	110	111
Phase difference		0°	45°	135°	90°	315°	270°	180°	225°

Phase differential coding INMARSAT and PHASE DIFF correspond to system standards Inmarsat-M and DVB according to ETS 300 429. The INMARSAT coding can generally be used for modulation types with 2 bits/symbol, such as QPSK. It uses the following algorithm.

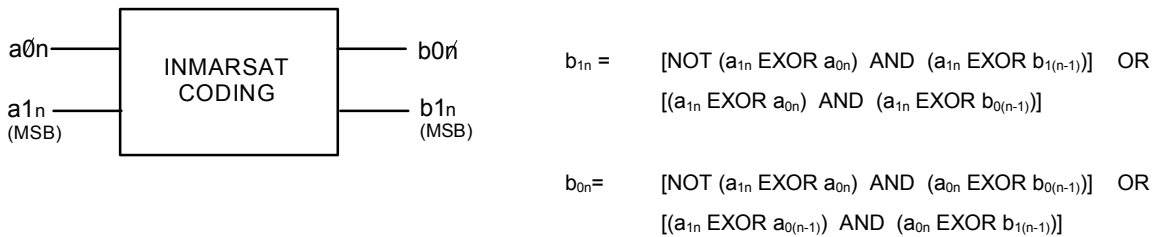

## Baseband Filter - Custom Digital Mod

The R&S Vector Signal Generator offers a wide selection of predefined baseband filters. The filter characteristic for the selected filter is displayed in the **More...** submenu in the **Filter** menu section (see "[More - Filter - Digital Modulation](#)", page 4.183)

The following table shows the filters that are available, together with the associated parameters and IEC bus commands. The filter characteristic is displayed in graphical form.

Table 4-9 Baseband filter

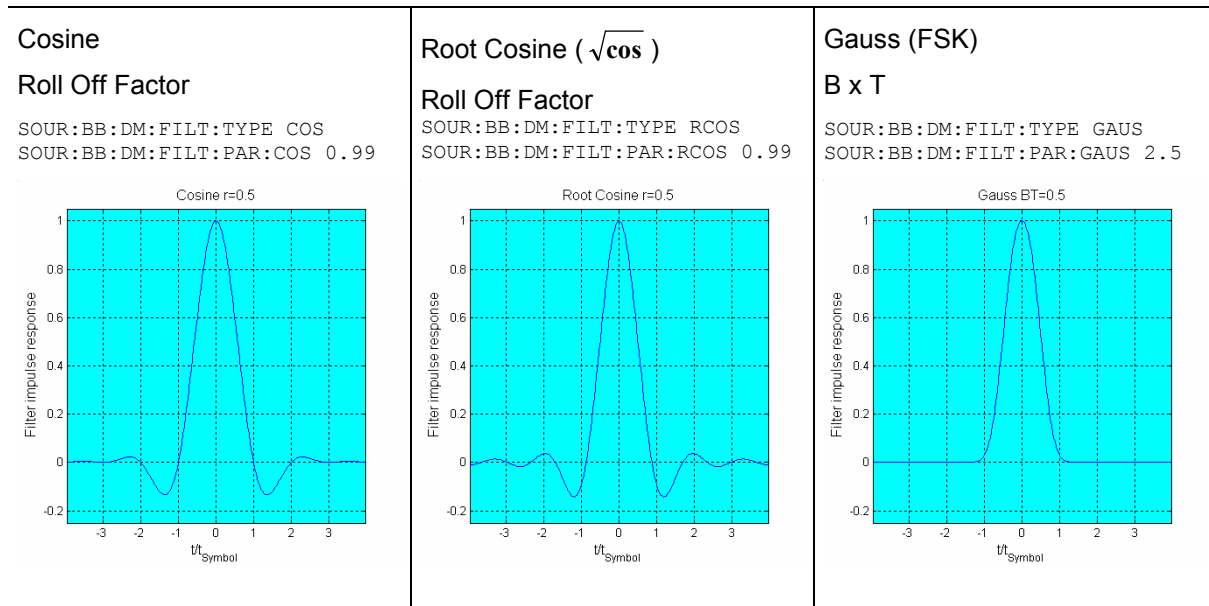

Pure Gauss

B x T

SOUR:BB:DM:FILT:TYPE PGA  
SOUR:BB:DM:FILT:PAR:PGA 2.5

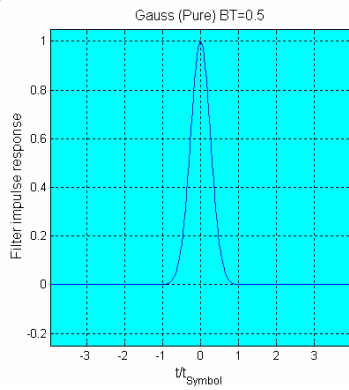

Gauss Linearized

SOUR:BB:DM:FILT:TYPE LGA

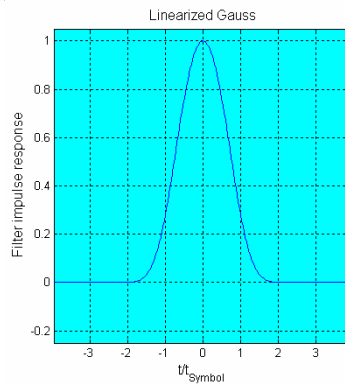

cdmaOne

SOUR:BB:DM:FILT:TYPE CONE

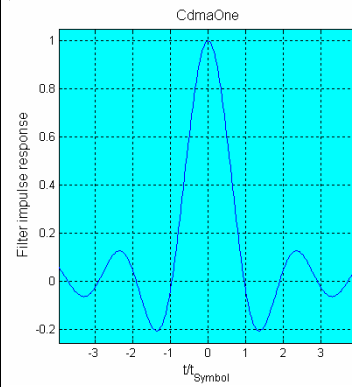

cdmaOne 705 kHz

SOUR:BB:DM:FILT:TYPE COF705

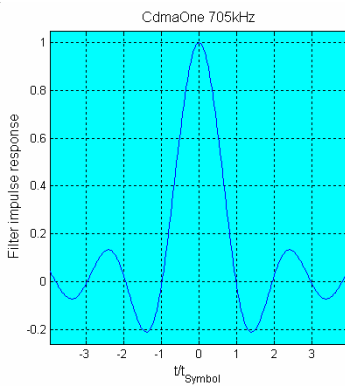

cdmaOne + Equalizer

SOUR:BB:DM:FILT:TYPE COE

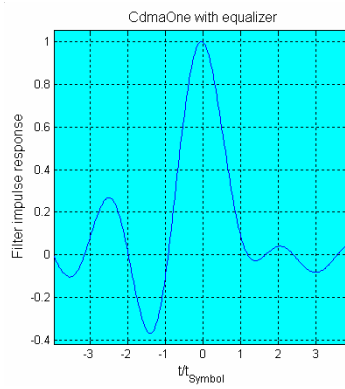

cdmaOne 705 kHz + Equalizer

SOUR:BB:DM:FILT:TYPE COFE

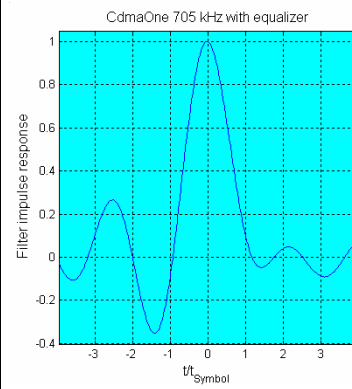

cdma2000 3X

SOUR:BB:DM:FILT:TYPE DM3x

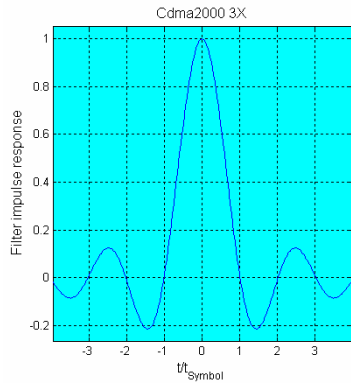

APCO25

Roll Off Factor

SOUR:BB:DM:FILT:TYPE APCO25  
SOUR:BB:DM:FILT:PAR:APC 0.5

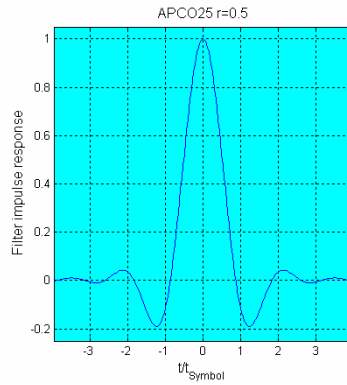

Split Phase

BxT

SOUR:BB:DM:FILT:TYPE SPH  
SOUR:BB:DM:FILT:PAR:SPH 0.15

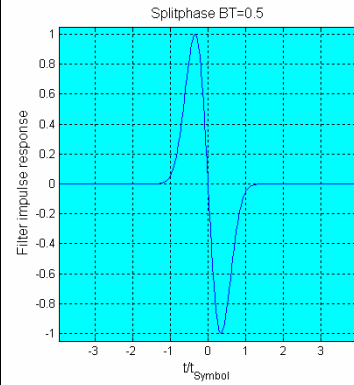

Rectangular

SOUR:BB:DM:FILT:TYPE RECT

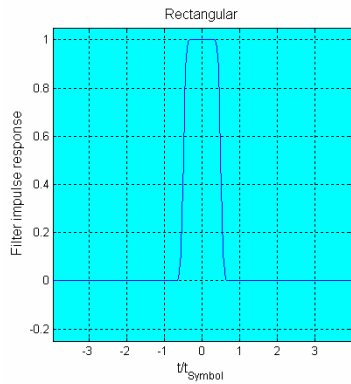

## Conflicting Settings - Custom Digital Mod

Having selected a modulation procedure, not every combination is possible when selecting the settings for the modulation parameters Symbol Rate and Coding. These restrictions inevitably give rise to conflicting settings if a parameter is changed and leads to a prohibited combination.

A conflicting setting is indicated by a message on the Info line in the display. The R&S Vector Signal Generator displays the setting entered by the user, but the modulation signal actually generated does not correspond to this display. A conflict of settings can be triggered if the user changes a parameter inappropriately. The message disappears as soon as a conflict-free setting is entered. A list of the possible settings conflicts and messages in digital modulation can be found in chapter 9 "Error messages".

## Custom Digital Mod Menu

The menu for setting digital modulation can be opened either in the **Baseband** block or in the menu tree under Baseband.

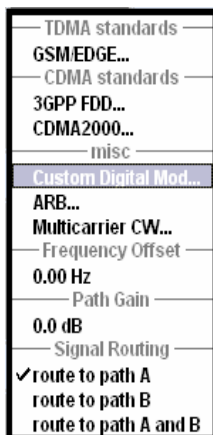

The **Custom Digital Modulation** menu enables direct selection of the data source, standard, symbol rate, coding, modulation type and filter. All other settings are entered in submenus which are called via **More** buttons.



The upper part of the menu is used for powering up digital modulation as well as for calling the default settings and user-defined standards.

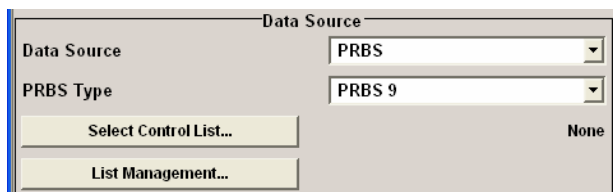

The data source is selected and set in the **Data Source** section.

The **More** button opens a submenu for calling the data editor and the file manager.



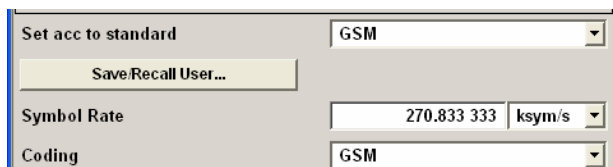

The middle part of the menu is used for selecting the standard, the symbol rate and the coding.

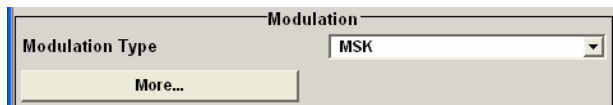

The modulation type is set in the **Modulation** section. The **More** button opens a submenu that displays the mapping for the selected modulation. This submenu can also be used to enable switching an RF signal between modulated and unmodulated.



The filter is set in the **Filter** section. The **More** button opens a submenu where the filter characteristic of the selected filter is displayed.

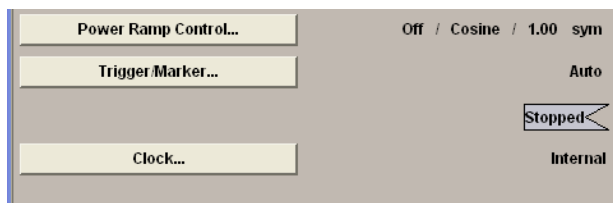

The buttons in the lower part of the menu open submenus for power ramping and for configuring triggers and clocks. In each case the current setting is displayed next to the button.

## Custom Digital Modulation Main Menu

The upper part of the menu is used for powering up digital modulation as well as for calling the default settings and user-defined standards.

**State - Digital Modulation** Enables/disables digital modulation.  
 Switching on digital modulation turns off all the other digital standards on the same path.  
 The digital modulation is generated in realtime (no precalculated signal), and therefore all parameter changes (in the ON state) directly affect the output signal.  
 Remote-control command:  
 SOUR:BB:DM:STAT ON

**Set To Default - Digital Modulation** Calls default settings. The values are shown in the following table.  
 Remote-control command:  
 SOUR:BB:DM:PRES

<b>Parameter</b>	<b>Value</b>
State	Not affected by Set to Default
Data Source	PRBS 9
Standard	GSM
Symbol Rate	270.833 ksymb/s
Coding	GSM
Modulation Type	MSK
Filter	Gauss (FSK)
Filter Parameter BxT	0.3
<b>Power Ramp Control</b>	
Attenuation	15 dB
Time	1 sym
Function	Cos
Fall Offset	0
Rise Offset	0
Source	Internal
State	Off
<b>Trigger</b>	
Mode	Auto
Source	Internal
Ext. Delay	0
Ext. Inhibit	0
<b>Clock</b>	
Source	Internal
Mode	Symbol
Delay	0

**Save/Recall - Digital Modulation**

Calls the **Save/Recall** menu.

From the **Save/Recall** menu the **File Select** windows for saving and recalling the complete settings in the **Custom Digital Modulation** menu can be called.



The Digital Modulation Settings are stored as files with the predefined file extension **\*.dm**. The file name and the directory they are stored in are user-definable.

The complete settings in the **Custom Digital Modulation** menu are saved and recalled.

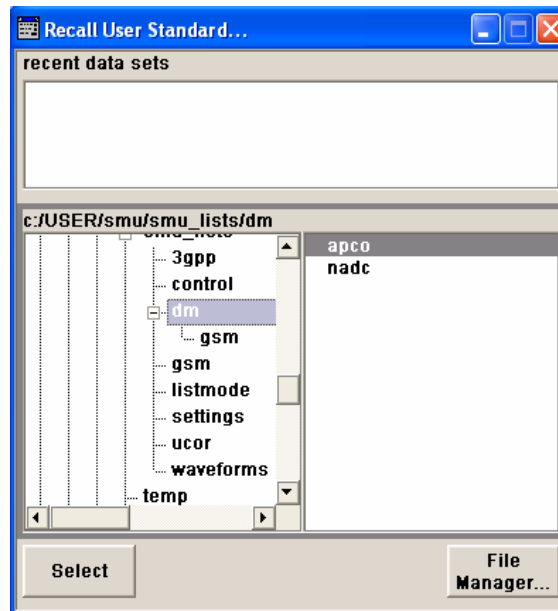

Remote-control commands:

```
MMEM:MDIR 'F:\gen\dig_mod\sett'
```

```
SOUR:BB:DM:SETT:CAT?
```

```
SOUR:BB:DM:SETT:DEL
```

```
SOUR:BB:DM:SETT:LOAD
```

```
SOUR:BB:DM:SETT:STOR
```

The data source is selected and set in the **Data Source** section. The parameters offered depend on the data source selected. The **More** button opens a submenu for calling the data editor and the file manager.

**Data Source - Digital Modulation**

Selects the data source (see also section "[Data and Signal Sources in Baseband](#)", page 4.150).

You may choose from the following data sources:

**All 0** 0 data or 1 data is internally generated.

**All 1** Remote-control command:  
`SOUR:BB:DM:SOUR ONE | ZERO`

**PRBS** PRBS data in accordance with the IUT-T with period lengths between  $2^9-1$  and  $2^{23}-1$  are internally generated.

**PRBS Type** The length is selected in the **PRBS Type** input box.



Remote-control commands:  
`SOUR:BB:DM:SOUR PRBS`  
`SOUR:BB:DM:PRBS 9|11|15|16|20|21|23`

**Pattern** A user-definable bit pattern with a maximum length of 64 bits is internally generated.

**Pattern** The bit pattern is defined in the **Pattern** input box.

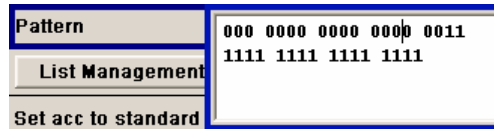

Remote-control command:  
`SOUR:BB:DM:SOUR PATT`  
`SOUR:BB:DM:PATT #H77550,17`

**Data List** Data lists will be used.  
**...Select Data** Data lists can be generated internally in the data editor or externally.

Data lists are selected in the **File Select** window, which is called by means of the **Select Data** button.

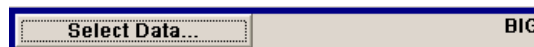

The **File Manager** is used to transmit external data lists to the R&S Vector Signal Generator, and can be called within every File Select window by means of the **File Manager** button.

Remote-control command:  
`SOUR:BB:DM:SOUR DLIS`  
`SOUR:BB:DM:DLIS:SEL "d_list1"`

**External Serial** External serial data is supplied via the DATA connector.

Remote-control command:  
`SOUR:BB:DM:SOUR SER`

**External Parallel (AUX I/O)** External parallel data is supplied externally via the PARDATA pins on the AUX I/O interface.

Remote-control command:  
 SOUR:BB:DM:SOUR PAR

**List Management - Digital Modulation**

Calls the menu for managing data and control lists (see section "[List Management - Digital Modulation menu](#)", page 4.185).

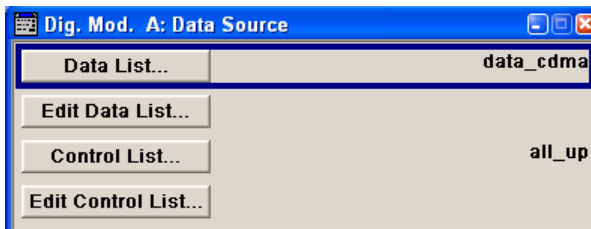

Remote-control command: n.a.

The middle part of the menu is used for selecting the standard, the symbol rate and the coding.

**Set acc. to Standard - Digital Modulation**

Selects a standard.

After selection, modulation parameters **Modulation Type**, **Symbol Rate**, **Filter** and **Coding** are automatically set in accordance with the standard.

If one of these parameters is subsequently altered, the display changes to User. The User setting can be saved to a file so that it can be recalled at some later time (**Save/Recall User...** button).

The following table shows the standards that are available, together with the associated settings of the modulation parameters.

Remote-control command:  
 SOUR:BB:DM:STAN PDC

Table 4-10 Standards - Custom Digital Modulation

Standard	Modulation	Symbol Rate	Filter	Coding	Parameter for IEC command
Bluetooth	2FSK, Deviation 160.0 kHz	1.0 Msym/s	Gauss, B*T = 0,5	OFF	BLUetooth
DECT	2FSK, Deviation 288.0 kHz	1.152 Msym/s	Gauss, B*T = 0,5	OFF	DECT
ETC (ARIB STD T55)	ASK, ASK Depth 100%	1.024 Msym/s	Split Phase, B*T = 2.0	OFF	ETC
GSM	MSK	270.833333 ksym/s	Gauss, B*T = 0.3	GSM	GSM
GSM EDGE	8PSK EDGE (3 $\pi$ /8 8PSK)	270.833333 ksym/s	Gauss linear	OFF	GSMEdge
NADC	$\pi$ /4 DQPSK	24.3 ksym/s	SQR COS, $\alpha$ = 0.35	NADC	NADC
PDC	$\pi$ /4 DQPSK	21.0 ksym/s	SQR COS, $\alpha$ = 0.50	PDC	PDC
PHS	$\pi$ /4 DQPSK	192.0 ksym/s	SQR COS, $\alpha$ = 0.50	PHS	PHS
TETRA	$\pi$ /4 DQPSK	18.0 ksym/s	SQR, $\alpha$ = 0.35	TETRA	TETRa
WCDMA 3GPP	QPSK 45° Offset	3.84 Msym/s	SQR, $\alpha$ = 0.22	WCDMA 3GPP	W3GPP
TD-SCDMA	QPSK 45° Offset	1.28 Msym/s	WCDMA 0.22	OFF	
cdma2000 Forward	QPSK	1.2288 Msym/s	cdmaOne + Equalizer	cdma2000	CFORward
cdma2000 Reverse	Offset QPSK	1.2288 Msym/s	cdmaOne	cdma2000	CREVerse
Worldspace	QPSK	1.84 Msym/s	SQR COS, $\alpha$ = 0.40	Worldspace	WORLdspace
TFTS	$\pi$ /4 DQPSK	22.1 ksym/s	SQR COS, $\alpha$ = 0.40	TFTS	TFTS

**Save/Recall User - Digital Modulation**

Calls the **Save/Recall User** menu.

From the **Save/Recall** menu the **File Select** windows for saving and recalling user-defined standards and the **File Manager** can be called.



User standards are stored as files with the predefined file extension **\*.dm\_stu**. The file name and the directory they are stored in are user-definable.

Remote-control commands:

```
MMEM:MDIR 'F:\gen\gen_lists\dm'
```

```
SOUR:BB:DM:STAN:ULIS:CAT?
SOUR:BB:DM:STAN:ULIS:DEL
SOUR:BB:DM:STAN:ULIS:LOAD
SOUR:BB:DM:STAN:ULIS:STOR
```

**Symbol Rate - Digital Modulation**

Selects the symbol rate.

The value range is dependent on the selected modulation type.

When the modulation type changes, the range is automatically redefined. If the set symbol rate is outside this range, an error message is generated and the maximum value for the newly chosen modulation type is automatically set.

Remote-control command:

```
SOUR:BB:DM:SRAT 15 MHz
```

**Coding - Digital Modulation** Selects the coding (see section "[Coding - Custom Digital Mod](#)", page 4.167 ).

The menu offers only the coding settings that are permissible for the chosen modulation type. The other coding methods are grayed out.

If the system is subsequently switched to a modulation type for which the selected coding is not available, coding is automatically set to OFF.

Remote-control command:

```
SOUR:BB:DM:COD
```

The modulation type is set in the **Modulation** section. The parameters offered depend on what is currently selected. The **More...** button opens a submenu for displaying the user-defined mapping.

**Modulation Type - Digital Modulation**

Selects a modulation type.

The associated symbol mapping is displayed in the **More...** submenu (see also table [Modulation type and associated mapping, page 4.163](#)).

If the coding that is set is not possible with the chosen modulation type, **coding** is set to **Off**.

You may choose from the following:

ASK, the PSK modulations BPSK, QPSK, QPSK 45° Offset, OQPSK,  $\pi/4$ -QPSK,  $\pi/2$ -DBPSK,  $\pi/4$ -DQPSK,  $\pi/8$ -D8PSK, 8PSK, 8PSK EDGE, the QAM modulations 16QAM to 1024QAM and the FSK modulations MSK, 2FSK, 4FSK and Variable FSK.

For selection "Variable FSK", the deviation of each symbol can be set in the **More...** submenu.

Remote-control command:

```
SOUR:BB:DM:FORM ASK
```

**ASK Depth - Digital Modulation**

Sets the modulation depth for ASK modulation.

Remote-control command:

```
SOUR:BB:DM:ASK:DEPT 100 PCT
```

**FSK Deviation - Digital Modulation**

Sets the frequency deviation for FSK modulation. The range of values depends on the chosen symbol rate (see data sheet).

Whenever **MSK** is selected, the deviation corresponds to 1/4 of the symbol rate and cannot be set.

Remote-control command:

```
SOUR:BB:DM:FSK:DEV 5 Hz
```



**More - Modulation Type - Digital Modulation**

Calls the submenu which displays the mapping of the currently selected modulation type and the digital modulation delay in the case of an external data source.

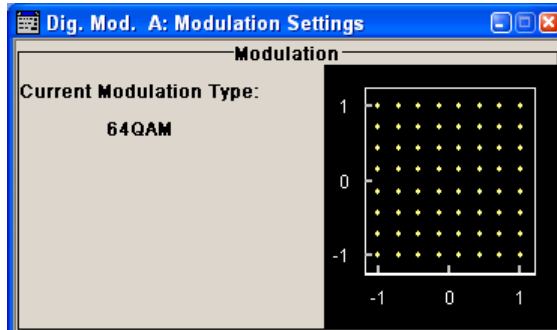

The **Modulation - CW Switching** section can be used to enable switching an RF signal between modulated and unmodulated.

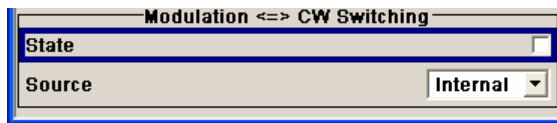

In case of selection **Variable FSK**, the FSK type and the deviation for each symbols is set in the **Variable FSK** section.

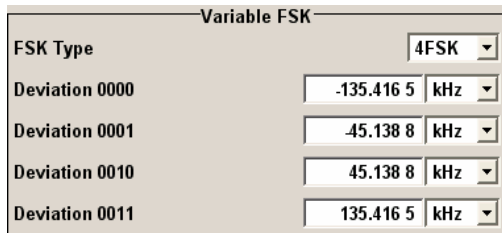

**FSK Type - Digital Modulation**

**(Variable FSK only)**

Selects the FSK modulation type for selection **Variable FSK**.

You may choose from 4FSK, 8FSK and 16FSK.

Remote-control command:

SOUR:BB:DM:FSK:VAR:TYPE FSK8

**Deviation xxxx - Digital Modulation**

**(Variable FSK only)**

Set the deviation of the associated symbol. The number of symbols depends on the selected modulation type. The value of each symbol is indicated in binary format.

Remote-control command:

SOUR:BB:DM:FSK:VAR:SYMB2:DEV 13E3

**Modulation Delay - Digital Modulation**

**(Data Source ext serial and ext parallel only)**

Displays the digital modulation delay from the data input to the I/Q output.

The value is displayed only if an external synchronous data source is selected. In this case the value represents the delay between the active clock edge for data and the corresponding peak I/Q value (associated with this data item) on the I/Q connectors.

Remote-control command:

SOUR:BB:DM:MDEL?

**Current Modulation Type - Digital Modulation**

Displays the currently selected modulation type together with its associated mapping.

Remote-control command: n.a.

The **Modulation ⇔ CW Switching** section is used to enable switching an RF signal between modulated and unmodulated.

**State Mod - CW - Digital Modulation**

**State**

Enables switching between a modulated and an unmodulated RF signal.

Switching is carried out by a control signal (CW) that is defined internally in the control list or supplied from an external source via a user-defined input.

Remote-control command:

SOUR:BB:DM:SWIT:SOUR INT  
 SOUR:BB:DM:CLIS:SEL 'CLIST1'  
 SOUR:BB:DM:SWIT:STAT ON  
 SOUR:BB:DM:SWIT:SOUR EXT  
 SOUR:BB:DM:SWIT:STAT ON

**Source Mod - CW - Digital Modulation**

Selects the CW control signal for switching between a modulated and an unmodulated RF signal.

**Internal**

The CW signal in the control list is used for the control. The internal signal can be output on one of the user interfaces.

Remote-control command:

SOUR:BB:DM:SWIT:SOUR INT

**External** The control signal on the CW pin of the AUX I/Q connector is used (path A and B).  
 Remote-control command:  
 SOUR:BB:DM:SWIT:SOUR EXT

**Filter - Digital Modulation** Selects the baseband filter (see also section "[Baseband Filter - Custom Digital Mod](#)", page 4.169).  
 Remote-control command:  
 SOUR:BB:DM:FILT:TYPE COS

The filter is set in the **Filter** section.

**Filter Parameter- Digital Modulation** Sets the filter parameter.  
 The filter parameter offered as the setting depends on the currently selected filter type.  
 Remote-control commands:  
 SOUR:BB:DM:FILT:PAR:APCO25 0.2  
 SOUR:BB:DM:FILT:PAR:COS 0.35  
 SOUR:BB:DM:FILT:PAR:GAUS 0.5  
 SOUR:BB:DM:FILT:PAR:PGA 0.5  
 SOUR:BB:DM:FILT:PAR:RCOS 0.35  
 SOUR:BB:DM:FILT:PAR:SPH 2

**More - Filter - Digital Modulation** Calls the menu for displaying the filter characteristic of the currently selected filter.

**Current Filter Response** Displays the filter characteristic of the currently selected filter.

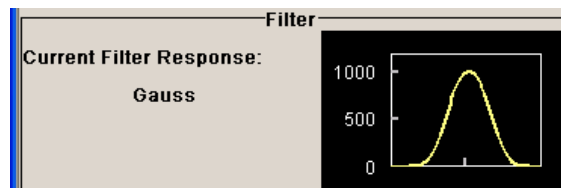

Remote-control command: n.a.

The lower part of the **Custom Digital Modulation** menu is used for setting triggers and clocks, as well as for power ramp settings.

**Power Ramp Control - Digital Modulation**

Calls the power ramp control menu (see section "[Power Ramp Control - Digital Modulation Menu](#)", page 4.195).

Remote-control command: n.a.

**Trigger/Marker - Digital Modulation**

Calls the **Trigger/Marker/Clock** menu. The **Trigger/Marker/Clock** menu is used to select the trigger source, set the time delay on an external trigger signal and configure the marker output signals (see section "[Trigger/Marker/Clock - Custom Digital Modulation Menu](#)", page 4.198).

Remote-control command: n.a.

**Execute Trigger - Digital Modulation**

Executes trigger manually. A manual trigger can be executed only when an internal trigger source and a trigger mode other than Auto have been selected.

Remote-control commands:

SOUR:BB:DM:TRIG:SOUR INT

SOUR:BB:DM:SEQ RETR

SOUR:BB:DM:TRIG:EXEC

**Clock - Digital Modulation**

Calls the **Trigger/Marker/Clock** menu. The **Trigger/Marker/Clock** menu is used to select the clock source (see section "[Trigger/Marker/Clock - Custom Digital Modulation Menu](#)", page 4.198).

Remote-control command: n.a.

## List Management - Digital Modulation menu

The **List Management** menu is called from the **Digital Modulation** main menu.

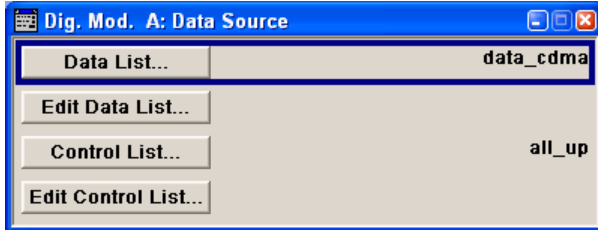

The data and control lists are selected and created in the **File Select** menu which is called up by means of the **Data List...** and **Control List...** buttons.



The **File Manager** is used to copy, rename and delete files and to create directories (see also Chapter 3, section "[File Management](#)")

To ensure that the selected data or control list is used for generating the digital signal, the list must be selected as the data source:

Data	Parameter	Selection
Digital data	Source:	DList
Marker	Marker Mode:	CList
Control signals CW, Level Attenuation and Burst Gate	Source	Internal

The data editor is called using the **Edit Data List...** and **Edit Control List...** buttons. The contents of the selected list are displayed. Operating the list editors is described in Chapter 3, section "[List Editors](#)".

**Select Data/Control List - Digital Modulation**

Selects data/control list. This opens the **File Select** window in which the data/control list can be selected.

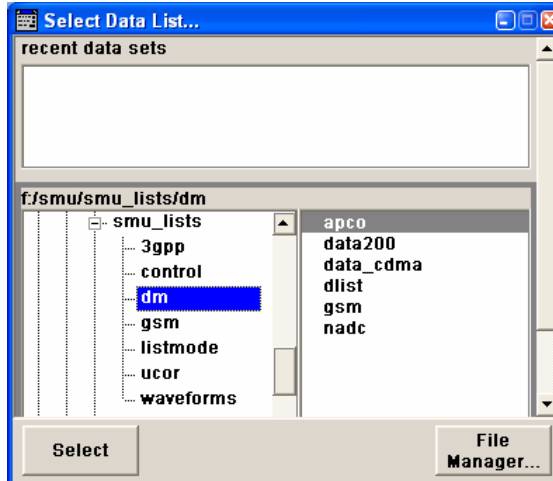

Remote-control commands:

```
SOUR:BB:DM:DLIS:SEL "d_list1"
SOUR:BB:DM:CLIS:SEL "c_list3"
```

**Create Data/Control List - Digital Modulation**

Creates new data/control list. This opens the **File Select** window in which the data/control list can be created.

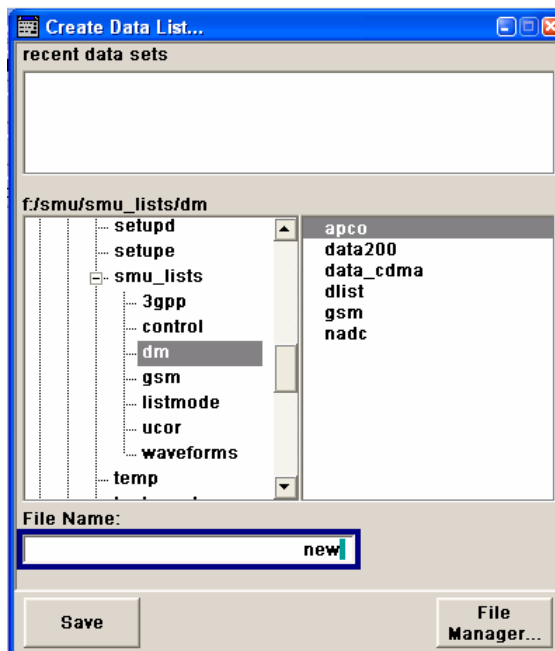

The file name has to be entered in field **File Name:**. The new list contains no data, it can be edited in the list editor.

Remote-control commands:

```
SOUR:BB:DM:DLIS:SEL "d_list1"
```

```
SOUR:BB:DM:CLIS:SEL "c_list3"
```

**File Manager - Digital Modulation**

Calls the **File Manager**.

The File Manager is used to copy, delete and rename files and to create new directories.

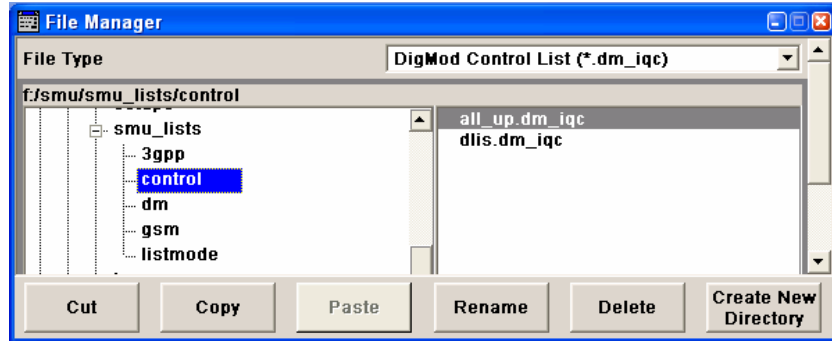

Remote-control commands:

```
SOUR:BB:DM:DLIS:SEL "d_list1"
SOUR:BB:DM:DLIS:COPY "D_list2"
SOUR:BB:DM:DLIS:DEL "c_list1"
SOUR:BB:DM:CLIS:SEL "c_list3"
SOUR:BB:DM:CLIS:COPY "c_list2"
SOUR:BB:DM:CLIS:DEL "c_list1"
MMEM:MDIR "D:\user\new"
```

**Data List Editor - Digital Modulation**

The **Data List Editor** for editing the selected data list is called up in the **Data/Control List Management** submenu of the **Digital Modulation** main menu by means of the **Edit Data List...** button. Chapter 3, Section "[List Editor](#)" describes how to use the editor.

A list of binary values with a maximum length of 2<sup>31</sup> bits can be entered in the **Data Editor**. This value corresponds to a file size of approx. 268 Mbyte. While it is being processed, the file is continuously automatically buffered. When the menu is exited, the file is automatically saved with the new values, i.e. there is no extra **Save** button. Depending on the size of the file, saving may take some time.

To increase readability, the bits are displayed in groups of four. The current cursor position, the length of the list and the list file name are displayed above the list. The offset starts with the value 0 which corresponds to the bit position on the left side of the first row, i.e. the beginning of the list. On the left edge of the editor, the last three offset positions are specified at the beginning of the row.

An existing list can be edited in the insert or overwrite mode.

Remote-control commands:

```
SOUR:BB:DM:DLIS:SEL "d_list1"
SOUR:BB:DM:DLIS:DATA 1,1,0,1,0,1,0,1,1,1,1,0,0,0
SOUR:BB:DM:DLIS:DATA:APP 1,1,0,1,0,1,0,1,1,1,1,0,0,0
```



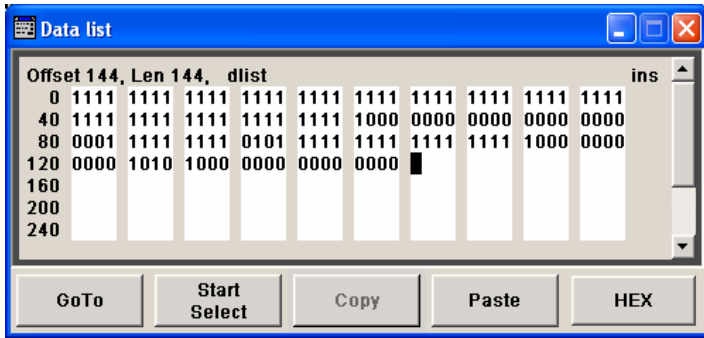

**GoTo - Digital Modulation** Opens the entry window for the bit position. The cursor marks the bit at the selected position.

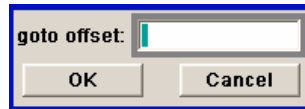

Remote-control command: n.a.

**Start Select - Digital Modulation** Defines the current cursor position as the start position for the range to be marked. The stop position is defined by entering an offset under **GoTo**.

When a start position has been activated, the button will be re-labelled to **Undo Select**. When the button is clicked now, the selected range will be deactivated.

Remote-control command: n.a.

**Copy - Digital Modulation** Copies the selected values.

Remote-control command: n.a.

**Cut - Digital Modulation** Cuts the selected values.

Remote-control command: n.a.

**Paste - Digital Modulation** Pastes the values that have been copied or cut before.

Remote-control command: n.a.

**Hex - Digital Modulation**      Switchover to hexadecimal display.

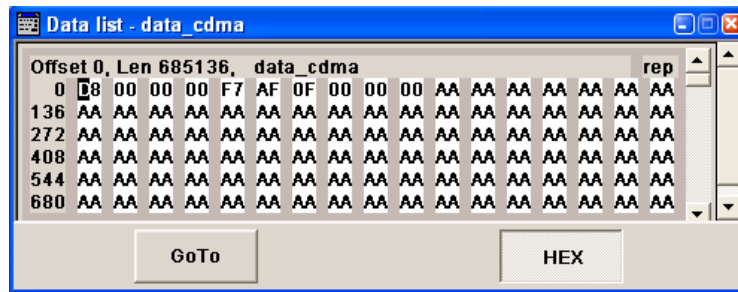

Each four bits are displayed as a hexadecimal value: To increase readability, the hexadecimal values in turn are displayed in pairs of two. The hex functions are automatically assigned to the numeric keys at the front panel.

Remote-control command: n.a.

## Control and Marker List Editor - Digital Modulation

The **Control and Marker List Editor** for editing the selected control list is called up in the **Data/Control List Management** submenu of the **Digital Modulation** main menu by means of the **Edit Control List...** button.



The four available marker signals and the CW, Hop, Burst Gate and Level Attenuation control signals can be defined in the **Control and Marker List Editor**.

**Note:**

*The marker signals thus defined will only become effective if the "CList" marker type in the **Trigger/Marker/Clock menu** is selected. The control signals thus defined will also only become effective if "Internal" has been selected as a **Source** in the individual setting menu, e.g. the **Power Ramp Control menu** for the **Burst Gate** and **Level Attenuation control signals**.*

While it is being processed, the file is continuously automatically buffered. When the menu is exited, the file is automatically saved with the new values, i.e. there is no extra **Save** button. Depending on the size of the file, saving may take some time.

The configuration of the currently selected control list is displayed. This list is either selected in the **File Select** menu (**Data/Control List Management** submenu by means of the **Control List...** button) or via

Remote-control commands:

```
SOUR:BB:DM:CLIS:SEL "c_list3"
SOUR:BB:DM:CLIS:DATA 0,8,8,8,8,8,8,0,0,0,...
```

The available marker/control signals are color-coded. In the left **Configure Control Signal** section, each individual signal is assigned a colour; a check in the check box shows the marker for which the "CList" marker type has been selected and the control signal for which the "Internal" source has been selected.

In the **Select Ramp to Edit** section the signal characteristics are graphically displayed. The scaling of the x-axis is always adapted to the overall length of the control list to provide constant overview of all defined ramps.

The ramps can be assigned the exact bit position in the signal by means of

- The bit scale below the marker/control signal characteristic.
- The display of the current cursor position in the **Cursor** menu section if the cursor marks the ramp.

The ramps can be set either graphically in the **Select Ramp to Edit** section or in the table of the **Positions <Signal>** section in the lower right corner. To make the setting easy, a selection of preset ramp characteristics is offered in the **Preset Ramp <Signal>** section.

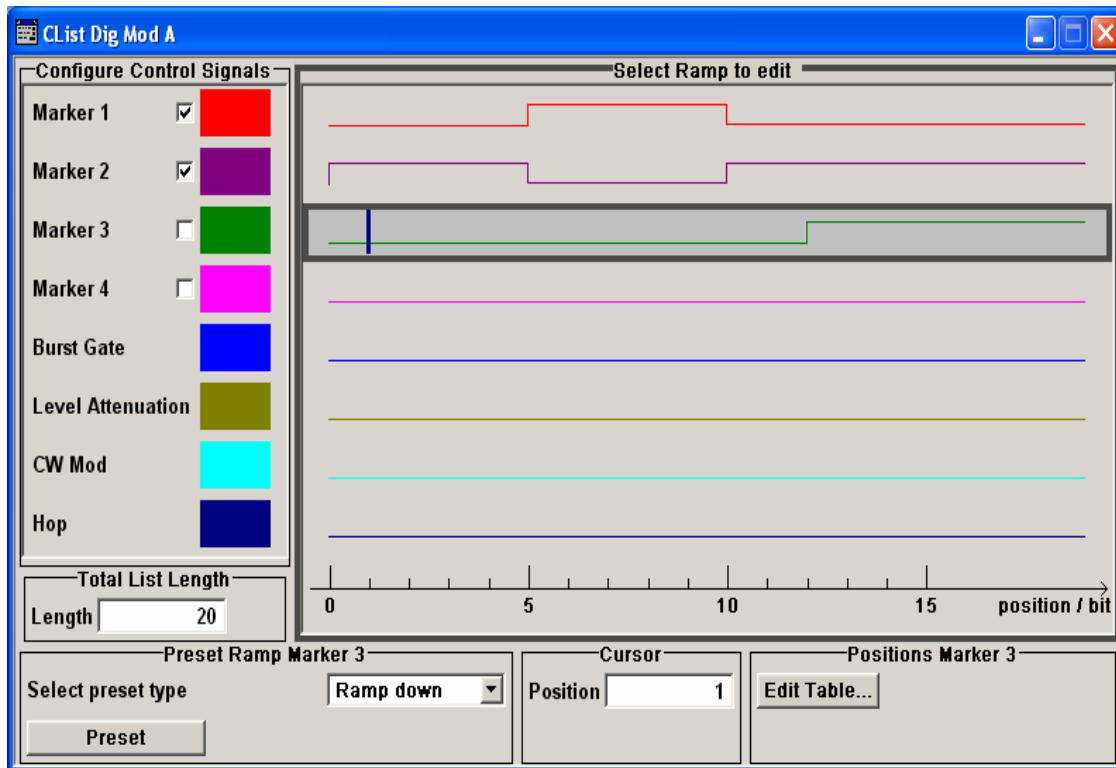

**Configure Control Signal -  
Digital Modulation**

Displays the colour the marker/control signal has been assigned.

Displays whether the "**CList**" marker type has been selected in the Trigger/Marker/Clock menu for this marker.

Displays whether the "**Internal**" source has been selected for this control signal in the individual setting menu. Burst Gate and Level Attenuation are set in the **Power Ramping** submenu, CW in the **Modulation** submenu.

The source "**CList/Internal**" for the individual marker/control signal can be selected here as well and will then be used in the associated menus.

Remote-control command: n.a.

**Select Ramp to Edit -  
Digital Modulation**

Graphically edit marker/control signals.

For this purpose, the cursor is set to the position where a ramp is required. The ramp is generated by pressing Enter (e.g. clicking on the rotary knob). Any number of ramps can be defined per marker. Each of the generated ramp positions will be saved even if the definition of another ramp produces a low/low or high/high transition. These ramps are displayed as dashed lines.

Existing ramps can be shifted after the cursor has been placed on the ramp and Enter has been pressed – it then changes colour twice. The ramp is shifted by using the cursor keys or the rotary knob. The new position is determined by pressing Enter again.

Ramps can be deleted by means of the **BACK-SPACE** key after the cursor has been placed on the ramp.

Chapter 3 describes in detail how to operate the control and marker list editor.

Remote-control command: n.a.

**Total List Length - Digital Modulation**

Enters the length of the definition range of the control list in bits. The starting value is always bit 0. The entire definition range is displayed, i.e. the bit scale is adapted to the entry.

With very long control lists, the displayed area can be zoomed to approx. 300 bits around the current cursor position (**Zoom in** button).

The preset functions set the ramp in the center of the currently selected area.

If the definition range is decreased, the ramps outside the range are lost.

When used, the control list is always repeated over the length of the definition range if the length of the data list exceeds the length of the control list.

Remote Control Command: n.a.

**Preset Ramp - Digital Modulation**

Activates presetting for the ramp characteristic of the selected control signal. The presetting is selected with **Select Preset Type** and activated by means of the **Preset** button.

Remote-control command:

You can select from:

- |                     |  |
|---------------------|--|
| <b>All Up</b>       | The marker/control signal is continuously high.  |
| <b>All Down</b>     | The marker/control signal is continuously low.   |
| <b>Ramp Up</b>      | The marker/control signal contains a ramp from low to high. The ramp is shifted to the center of the displayed signal area and can subsequently be shifted as required.  |
| <b>Ramp Down</b>    | The marker/control signal contains a ramp from high to low. The ramp is shifted to the center of the displayed signal area and can subsequently be shifted as required.  |
| <b>Ramp Up/Down</b> | The marker/control signal contains a ramp from low to high and from high to low. The ramps are symmetrically shifted around the center of the displayed signal area and can subsequently be shifted as required. |
| <b>Ramp Down/Up</b> | The marker/control signal contains a ramp from high to low and from low to high. The ramps are symmetrically shifted around the center of the displayed signal area and can subsequently be shifted as required. |

**Cursor Position - Digital Modulation**

Enters the cursor position.

In the graphic display, the cursor is positioned according to the entry.

Vice versa, graphically shifting the cursor will change the displayed value.

If the entered value exceeds the selected length of the definition range, the length is adjusted automatically.

Remote-control command: n.a.

**Ramp Positions - Digital Modulation**

Opens table by using the **Edit Table...** button.

The ramps of the selected signal can be edited in the table. When the table is opened, the current configuration of the selected marker/control signal is displayed.

	Ramp Positions	Ramp State
1	20	High
2	50	Low
3	66	High
4	71	Low
5	81	High
6	223	Low
7		Low
		High

Accept

The bit position is specified in the **Ramp Position** column, the high or low signal status in the **Ramp State** column. At the end of the list, there is always a blank row for entering new values.

The changes are accepted in the graphic display after pressing the **Accept** button.

Remote-control command: n.a.

**Zoom - Digital Modulation**

Zooms the displayed area of the control list. The designation of the button changes from **Zoom in** to **Zoom out**.

With very long control lists, the displayed area can be zoomed to approx. 300 bits around the current cursor position.

Ramps outside the displayed area are not lost by zooming.

Remote-control command: n.a.

## Power Ramp Control - Digital Modulation Menu

The Power Ramp Control menu is accessed via the **Digital Modulation** main menu.

The menu is used to set the power ramping. Control signals **Burst** and **Lev\_Att** are used to control power ramping (see also section "[Power Ramping and Level Attenuation](#)", page 4.159).

**Note:**

*Power ramping is possible up to a symbol rate of 5 MHz. If a higher symbol rate is set, power ramping is automatically switched off and an error message is output.*

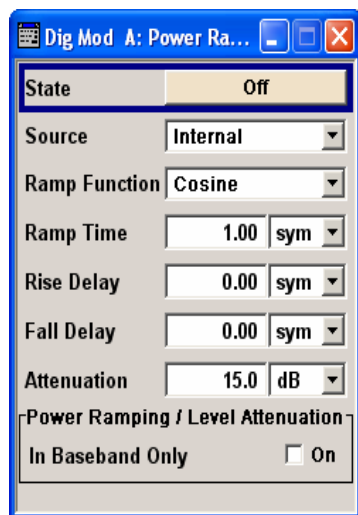

**State - Power Ramp Control - Digital Modulation**

Enables/disables power ramping.

Remote-control command:  
 SOUR:BB:DM:PRAM:STAT ON

**Source - Power Ramp Control - Digital Modulation**

Enters the source for the power ramp control signals.

**Internal**

The control signals in the internal control list are used for control purposes. The signals are output on the LEV\_ATT and BURST pin on the AUX I/O interface (path A). In the case of two-path instruments the path B signal can be placed on one of the USER interfaces.

Remote-control command:  
 SOUR:BB:DM:PRAM:SOUR INT

**External Digital**

The control signal is fed in via the AUX I/O interface (path A = LEV-ATT pin, path B = user-definable USER pin or USER connector).

Remote-control command:  
 SOUR:BB:DM:PRAM:SOUR EXT

**Ramp Function - Digital Modulation**

Enters the form of the transmitted power, i.e. the shape of the rising and falling edges during power ramp control.

**Linear** The transmitted power rises and falls linear fashion.

Remote-control command:  
`SOUR:BB:DM:PRAM:SHAP LIN`

**Cosine** The transmitted power rises and falls with a cosine-shaped edge. This gives rise to a more favorable spectrum than the **Linear** setting.

Remote-control command:  
`SOUR:BB:DM:PRAM:SHAP COS`

**Ramp Time - Digital Modulation**

Enters the power ramping rise time and fall time for a burst. The setting is expressed in symbols.

Remote-control command:  
`SOUR:BB:DM:PRAM:TIME 2.5`

**Rise Delay - Power Ramp Control - Digital Modulation**

Sets the offset in the rising edge of the envelope at the start of a burst. A positive value gives rise to a delay (see figure, the envelope length decreases) and a negative value causes an advance (the envelope length increases). The setting is expressed in symbols.

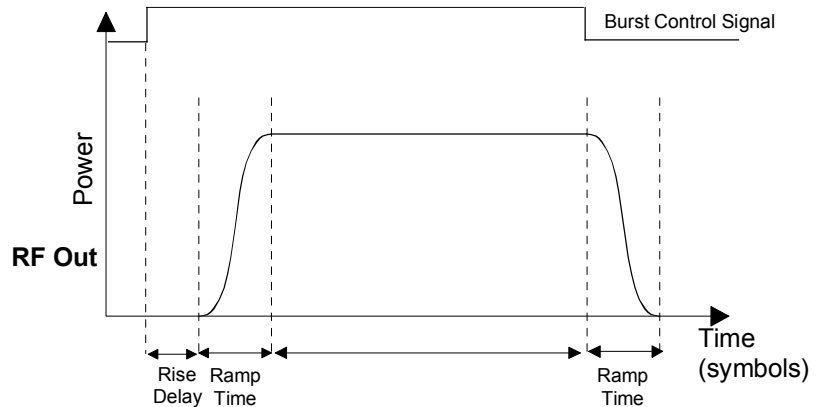

Remote-control command:  
`SOUR:BB:DM:PRAM:RDEL -1`



**Fall Delay - Power Ramp Control - Digital Modulation**

Sets the offset in the falling edge of the envelope at the end of a burst. A positive value gives rise to a delay (see figure, the envelope length increases) and a negative value causes an advance (the envelope length decreases). The setting is expressed in symbols.

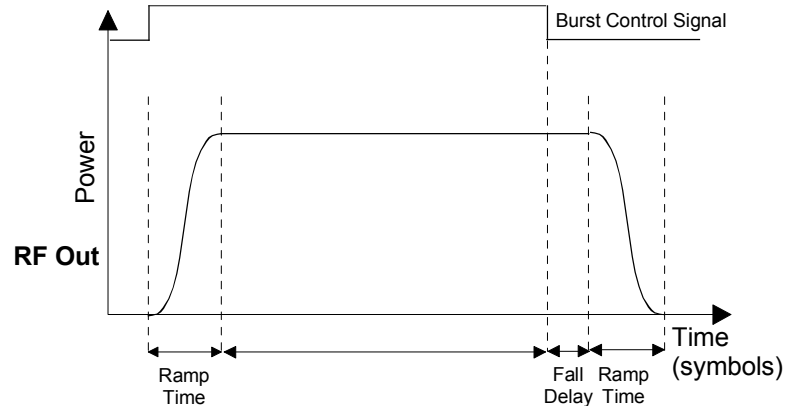

Remote-control command :

SOUR:BB:DM:PRAM:FDEL -1

**Attenuation - Power Ramp Control - Digital Modulation**

Sets the level attenuation relative to the average level for the signal ranges in which the level is set to **attenuated** (LEV\_ATT control signal).

The LEV\_ATT control signal is defined in the **Control Data Editor** or supplied via the LEV\_ATT pin (path A) or a user-defined USER pin (path B) on the AUX I/O interface.

Remote-control command :

SOUR:BB:DM:PRAM:ATT 15 dB

**Baseband Only - Power Ramp Control - Digital Modulation**

Restricts power ramping to the baseband signal.

**Off**

Level attenuation is effected via the attenuator stages in the RF section; only the remaining part is attenuated in the baseband. The signal is issued at the RF output with the defined level values.

Remote-control command: :

SOUR:BB:DM:PRAM:BBON OFF

On

Level attenuation is effected in the baseband only. This setting is mandatory in the following cases: When only the baseband signal is issued at the I/Q outputs. It is thus ensured that, with power ramping active, this signal is output with the defined level values.

When a baseband signal is applied to two RF paths. The RF paths having separate frequency and level settings, the remaining attenuation to be effected in the baseband would have to be different for the two paths and is therefore not possible.

Remote-control command:

SOUR:BB:DM:PRAM:BBON ON

## Trigger/Marker/Clock - Custom Digital Modulation Menu

The Trigger menu is accessed via the **Digital Modulation** main menu.

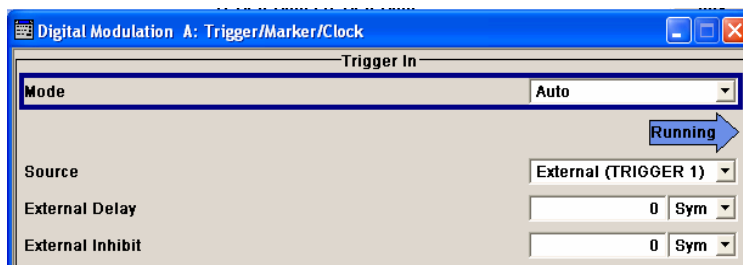

The **Trigger In** section is where the trigger for the modulation signal is set. Various parameters will be provided for the settings, depending on which trigger source - internal or external - is selected. The current status of signal generation (**Running** or **Stopped**) is indicated for all trigger modes.

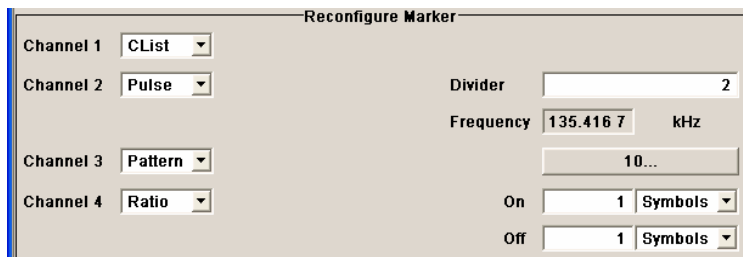

The **Reconfigure Marker** section is where the marker signals at the MARKER output connectors are configured.

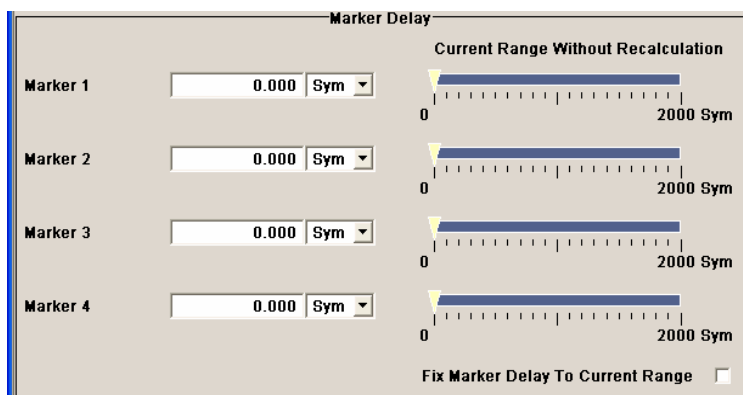

The **Marker Delay** section is where a marker signal delay can be defined, either without restriction or restricted to the dynamic section, i.e., the section in which it is possible to make settings without restarting signal and marker generation.

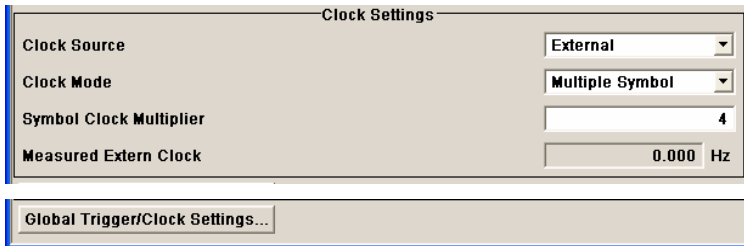

The **Clock Settings** section is where the clock source is selected and - in the case of an external source - the clock type.

The **Global Trigger/Clock Settings** button leads to a submenu for general trigger, clock and external input settings.

The **Trigger In** section is used to configure the trigger signal for the digital modulation. The current status of signal generation is indicated for all trigger modes.

**Trigger Mode - Digital Modulation**

Selects trigger mode.

**Auto** The digital modulation signal is generated continuously.

Remote-control command:  
SOUR:BB:DM:SEQ AUTO

**Retrigger** The digital modulation signal is generated continuously. A trigger event (internal with **Execute Trigger** or external) causes a restart.

Remote-control command:  
SOUR:BB:DM:SEQ RETR

**Armed\_Auto** The digital modulation signal is generated only when a trigger event occurs. Then the digital modulation signal is generated continuously.

Button **Arm** stops signal generation. A subsequent trigger event (internal with **Execute Trigger** or external) causes a restart.

Remote-control command:  
SOUR:BB:DM:SEQ AAUT

**Armed\_Retrigger** The digital modulation signal is generated only when a trigger event occurs. Then the signal is generated continuously. Every subsequent trigger event (internal with **Execute Trigger** or external) causes a restart.

Button **Arm** stops signal generation. A subsequent trigger event (internal with **Execute Trigger** or external) causes a restart.

Remote-control command:  
SOUR:BB:DM:SEQ ARET

**Single** The digital modulation signal is generated only when a trigger event occurs. Then the signal is generated once to the length specified at **Signal Duration**. Every subsequent trigger event (internal with **Execute Trigger** or external) causes a restart.

Remote-control command:  
SOUR:BB:DM:SEQ SING

**Trigger Signal Duration - Digital Modulation** Enters the length of the signal sequence to be output in the **Single** trigger mode. The input is to be expressed in symbols.

Remote-control commands:  
 SOUR:BB:DM:TRIG:SLEN 200

**Running - Stopped - Digital Modulation** Displays the status of signal generation for all trigger modes. This display appears only when Custom Dig Mod is enabled (**State On**).

Remote-control command:  
 SOUR:BB:DM:TRIG:RMOD?  
 Response: RUN or STOP

**Running** The digital modulation signal is generated; a trigger was (internally or externally) initiated in triggered mode.  
 If **Armed\_Auto** and **Armed\_Retrigger** have been selected, generation of signals can be stopped with the **Arm** button. A new trigger (internally with **Execute Trigger** or externally) causes a restart.

**Stopped** The signal is not generated, and the instrument waits for a trigger event (internal or external).

**Arm - Digital Modulation** Stops signal generation. This button appears only with **Running** signal generation in the **Armed\_Auto** and **Armed\_Retrigger** trigger modes.

Signal generation can be restarted by a new trigger (internally with **Execute Trigger** or externally).

Remote-control command:  
 SOUR:BB:DM:TRIG:ARM:EXEC

**Execute Trigger - Digital Modulation** Executes trigger manually. A manual trigger can be executed only when an internal trigger source and a trigger mode other than **Auto** have been selected.

Remote-control commands:  
 SOUR:BB:DM:TRIG:SOUR INT  
 SOUR:BB:DM:SEQ RETR  
 SOUR:BB:DM:TRIG:EXEC

**Trigger Source - Digital Modulation** Selects trigger source.

<b>Internal</b>	<p>The trigger event is executed by <b>Execute Trigger</b>. As a precondition a trigger mode other than <b>Auto</b> must be selected.</p> <p>Remote-control command: SOUR:BB:DM:TRIG:SOUR INT</p>
<b>Internal (Baseband A/B)</b>	<p>The trigger event is executed by the trigger signal from the second path (two-path instruments only).</p> <p>Remote-control command: SOUR:BB:DM:TRIG:SOUR OBAS</p>
<b>External (TRIGGER 1/2)</b>	<p>The trigger event is executed with the aid of the active edge of an external trigger signal. The trigger signal is supplied via the TRIGGER 1 or TRIGGER 2 connector.</p> <p>The polarity, the trigger threshold and the input impedance of the TRIGGER input can be set in the <b>Global Trigger Settings</b> menu.</p> <p>Remote-control command: SOUR:BB:DM:TRIG:SOUR BEXT</p>

### Trigger Delay - Digital Modulation

Sets trigger signal delay in symbols on external triggering or on internal triggering via the second path.

This enables the R&S Vector Signal Generator to be synchronized with the device under test or other external devices.

---

#### **Note**

*The delay can be set separately for each of the two paths.*

---

Remote-control command:  
SOUR:BB:DM:TRIG:EXT:DEL 3  
SOUR:BB:DM:TRIG:OBAS:DEL 3

**Trigger Inhibit - Digital Modulation**

Sets the duration for inhibiting a new trigger event subsequent to triggering. The input is to be expressed in symbols.

In the **Retrigger** mode every trigger signal causes signal generation to restart. This restart is inhibited for the specified number of samples.

This parameter is only available on external triggering or on internal triggering via the second path.

**Note:**

*The trigger inhibit can be set separately for each of the two paths.*

Remote-control command :

```
SOUR:BB:DM:TRIG:EXT:INH 0
SOUR:BB:DM:TRIG:OBAS:INH 0
```

The marker output signal for synchronizing external instruments is configured in the **Marker Settings** section **Reconfigure Marker**.

**Marker x - Digital Modulation**

Selects a marker signal for the associated MARKER output.

**CList**

A marker signal that is defined in the selected control list is generated.

Remote-control commands :

```
SOUR:BB:DM:TRIG:OUTP1:MODE CLIS
SOUR:BB:DM:CLIS:SEL 'control_dm'
```

**Pulse**

A regular marker signal is generated. The clock frequency is defined by entering a divider. The frequency is derived by dividing the sample rate by the divider. The input box for the divider opens when **Pulse** is selected, and the resulting pulse frequency is displayed below it.

Divider	8.00
Frequency	33.854 17 kHz

Remote-control commands :

```
SOUR:BB:DM:TRIG:OUTP1:MODE PULS
SOUR:BB:DM:TRIG:OUTP1:PULS:DIV 4
SOUR:BB:DM:TRIG:OUTP1:PULS:FREQ?
```

**Pattern**

A marker signal that is defined by a bit pattern is generated. The pattern has a maximum length of 32 bits and is defined in an input field which opens when **pattern** is selected.

0000 0000
-----------

Remote-control commands:

```
SOUR:BB:DM:TRIG:OUTP1:MODE PATT
SOUR:BB:DM:TRIG:OUTP1:PATT #B1111,4
```

**ON/OFF ratio**

A regular marker signal that is defined by an ON/OFF ratio is generated. A period lasts one ON and OFF cycle.

Start of signal

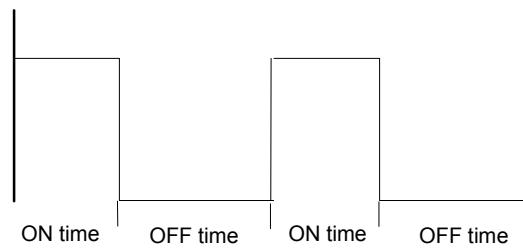

The ON time and OFF time are each expressed as a number of symbols and are set in an input field which opens when **ON/OFF ratio** is selected.

On Time	<input type="text" value="2"/>	Sym
Off Time	<input type="text" value="3"/>	Sym

Remote-control commands:

```
SOUR:BB:DM:TRIG:OUTP1:MODE RAT
```

```
SOUR:BB:DM:TRIG:OUTP1:OFFT 20
```

```
SOUR:BB:DM:TRIG:OUTP1:ONT 20
```

The **Marker Delay** section can be used to set a delay for the markers.

**Marker x Delay - Digital Modulation**

Enters the delay between the marker signal at the marker outputs and the start of the signal.

The input is expressed as a number of symbols.

If the setting "**Fix marker delay to dynamic range**" is enabled, the setting range is restricted to the dynamic range. In this range the delay of the marker signals can be set without restarting the marker and signal.

The allocation of marker signals to the outputs is described in the section "[Marker Output Signals](#)", page 4.161.

Remote-control command:

```
SOUR:BB:DM:TRIG:OUTP2:DEL 20
```

**Current Range without Recalculation - Digital Modulation**

Displays the dynamic range within which the delay of the marker signals can be set without restarting the marker and signal.

The delay can be defined by moving the setting mark.

Remote-control command:

```
SOUR:BB:DM:TRIG:OUTP:DEL:MAX?
```

```
SOUR:BB:DM:TRIG:OUTP:DEL:MIN?
```

**Fix marker delay to current range - Digital Modulation** Restricts the marker delay setting range to the dynamic range. In this range the delay can be set without restarting the marker and signal.

Remote-control command:  
`SOUR:BB:DM:TRIG:OUTP:DEL:FIX ON`

The clock source is selected in the **Clock Settings** section.

**Clock Source - Digital Modulation** Selects the clock source (also see section Clock Signals page 4.154).

**Intern** The internal clock reference is used.

Remote-control command:  
`SOUR:BB:DM:CLOC:SOUR INT`

**Extern** The external clock reference is fed in as the symbol clock or multiple thereof via the CLOCK connector.

The chip rate must be correctly set to an accuracy of  $\pm 2\%$  (see data sheet).

The polarity of the clock input can be changed with the aid of **Global Trigger/Clock/External Input Settings**.

In the case of two-path instruments this selection applies to path A.

Remote-control command:  
`SOUR:BB:DM:CLOC:SOUR EXT`

**Clock Mode - Digital Modulation** Enters the type of externally supplied clock.

**Symbol** A symbol clock is supplied via the CLOCK connector.

Remote-control command:  
`SOUR:BB:DM:CLOC:MODE SYMB`

**Multiple Symbol** A multiple of the symbol clock is supplied via the CLOCK connector, the symbol clock is derived internally from this.

The **Multiplier** window provided allows the multiplication factor to be entered.

---

**Note:**  
*This setting is not possible if the serial or parallel external data source is selected.*

---

Remote-control command:  
`SOUR:BB:DM:CLOC:MODE MSYM`  
`SOUR:BB:DM:CLOC:MULT 4`



**Bit** A bit clock is supplied via the CLOCK connector; the symbol clock is derived internally from this.

---

**Note:**

*This setting is not possible if the serial or parallel external data source is selected.*

---

Remote-control command:

SOUR:BB:DM:CLOC:MODE BIT

**Symbol Clock Multiplier - Digital Modulation**

Enters the multiplication factor for clock type **Multiple**.

Remote-control command:

SOUR:BB:DM:CLOC:MULT 4

**Measured External Clock - Digital Modulation**

Displays the measured frequency of the external clock signal. This enables the user to permanently monitor the frequency of the externally introduced clock.

This information is displayed only if the external clock source has been selected.

Remote-control command:

:CLOC:INP:FREQ?

**Global Trigger/Clock/Input Settings - Digital Modulation**

Calls the **Global Trigger/Clock/Input Settings** menu. This menu is used among other things for setting the trigger threshold, the input impedance and the polarity of the clock and trigger inputs. In the case of two-path instruments these settings are valid for both paths. The parameters in this menu affect all digital modulations and standards, and are described in the section "[Global Trigger/Clock/Input Settings – Setup -Environment](#)".

# Arbitrary Waveform Generator ARB

## Introduction - ARB

The Arbitrary Waveform Generator is an I/Q modulation source forming an integral part of the R&S Vector Signal Generator. It can be used to output any externally calculated modulation signals or internally generated multi carrier signals.

The Arbitrary Waveform Generator is incorporated in the Baseband Generator (B9/B10/B11)) option. The Baseband Main Module (B13) option is also required. The three Baseband Generator options feature different ARB memory sizes (see data sheet). Apart from the memory size, however, the two options offer the same functionality, either one can be installed.

In the case of two-path instruments, at least one further Baseband Generator (B9/B10/B11) option is needed for waveform output in the second path. Using this option a waveform can be read in on path B and then either routed via path A or added to the signal on path A with a baseband frequency offset that can be set. When path B is fully expanded with a second option Baseband Main Module (B13) and an RF section Frequency Option (B20x) the waveform can be output on RF output B.

Waveform files can be loaded into the instrument via one of the computer interfaces (USB - memory stick, or Ethernet interface - network drive) or via the IEC bus.



A Windows software package **WinIQSIM** is available for generating external waveform files on a PC.

It is included among the items and services supplied with the Baseband Generator (B9/B10/B11) option. With effect from version 4.10 and higher, this software defines waveforms in a format which fully exploits the extended functionality of the R&S Vector Signal Generator (e.g. 16-bit resolution, extended memory capacity).

Even so the R&S Vector Signal Generator will still accept waveforms which have been generated using earlier versions of the **WinIQSIM** package.

A file in the "Wavebase 2" directory on the **WinIQSIM** CD-ROM contains a selection of predefined waveforms complete with their descriptions.

It is no longer possible to read out the **WinIQSIM** settings from the waveform. For the purpose of generating marker signals, **WinIQSIM** provides predefined settings for the bit clock and symbol clock as well as the slot and frame triggers. Since  $S_i \left( \frac{\sin(x)}{x} \right)$

compensation and filter compensation are carried out in the R&S Vector Signal Generator, these features are not supported by **WinIQSIM**.

It is also possible to transfer signals that have been calculated using a mathematical program such as Matlab (see also Application Note 1MA28, IQWizard - I/Q Signal Measurement and Conversion, which can be obtained by visiting the Rohde&Schwarz web site at <http://www.rohde-schwarz.com>).

The R&S Vector Signal Generator can actually generate ARB waveforms internally. These files are created and saved in the **ARB** menu.

It is possible to use either predefined or subsequently defined markers that are sent to the marker outputs in synchronicity with the I/Q output signals. The markers have to be selected in the menu and a delay can be selected by the user (see "[Trigger/Marker/Clock - ARB MOD Menu](#)", page 4.219).

Multisegment waveforms consisting of a combination of multiple waveforms can be defined in order to enable rapid alternation between different waveforms with differing test signals. Such waveforms can be used in test systems, for example. Each segment represents a completely independent waveform that is output with its own marker and clock settings. The entire multisegment waveform is loaded into memory. The segment intended to be output at any given moment can be selected by the user. It is therefore possible to alternate between the individual waveform segments without experiencing any delay due to the loading operation.

If very high switchover speeds are required, the test signals can be continuously scrolled through with the aid of an external trigger. For this purpose the segments must have a common sample rate. If the combined waveforms have different sample rates, they can be adapted to a common sample rate by resampling. By the same procedure the instantaneous amplitude of the various waveforms can be scaled to a common rms level.

Typical applications for the multisegment mode are described in the section "[Typical Applications for Multisegment Waveforms - ARB Menu](#)", page 4.233.

Multi-carrier waveforms consisting of up to 32 carriers modulated by user-selectable baseband signals can be created in order to simulate complex multi-carrier scenarios with different baseband signals (e.g. CDMA200 or 3GPP FDD).

The ARB has been produced in the form of an interpolating ARB generator. The resampler operates in such a way that a modulation signal with a sample rate of less than 100 MHz is interpolated on the 100-MHz sample rate and then used as output.

The sample rate must satisfy the following condition:

$$\text{Sample rate} \times 0.31 \geq \text{modulation bandwidth}$$

In the case of digital modulation: Sample rate = symbol rate (or chip rate) x oversampling

The value for the necessary oversampling is then calculated as follows:

$$\text{Oversampling} \geq \frac{\text{modulation bandwidth}}{\text{symbol (chip)rate} \times 0.31}$$

**Example:**

For the WCDMA digital standard with baseband filter  $\sqrt{\cos}$ ,  $\alpha = 0.22$  the following value is therefore calculated for the necessary oversampling:

$$\text{Modulation bandwidth} = \frac{(1+\alpha)}{2} = 0.61, \quad \text{Oversampling} \geq \frac{0.61}{0.31} = 1.97.$$

A modulation signal with a sample rate of exactly 100 MHz is passed directly to the Analog/Digital converter. The bandwidth is limited to 40 MHz by the lowpass filter only.

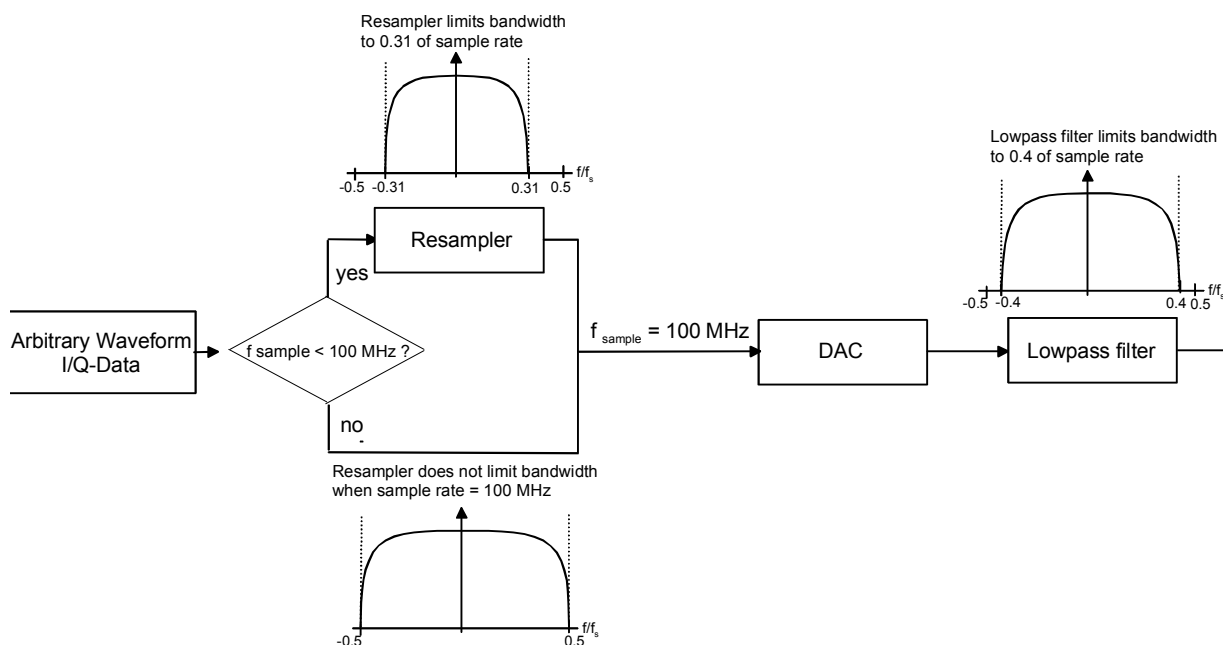

The reduced oversampling means that the signal duration is increased when the number of sample values is constant. Accordingly it is the case that when the duration is constant there is a reduction in the required number of sample values. In conventional ARB generators the minimum oversampling is normally held at 4. It therefore follows that with the above WCDMA system parameters and oversampling of 4 for the generation of a waveform with 10 frames (38 400 chips each) 1.5 Msamples are needed. The same waveform needs 740 ksamples in the R&S Vector Signal Generator due to the lower oversampling of 1.97.

Modulation signals generated with the aid of the **WinIQSIM** software can be optimized by selecting whole number oversampling or by defining a target sample rate, with the aim of achieving optimum exploitation of the maximum possible useful bandwidth, reducing the length of the waveform or obtaining the most extensive possible useful signal in the memory, according to need. Thus at the default target sample rate of 100 MHz, the maximum bandwidth of 40 MHz is available (see above, Signals with a sample rate of exactly 100 MHz).

Modulation signals can be generated without marker signals, whenever the marker functionality can be directly provided by the R&S Vector Signal Generator, thus increasing the maximum waveform length.

The resolution for the I/Q data is 16 bits (16 bits I, 16 bits Q) and there are 4 bits available for the markers. I/Q data and marker data are located in separate memory areas of the SDRAM and can be independently configured (for example the same output clock but different periods).

A memory size of 256 MB (B10) yields a maximum waveform length of 56 MSamples (36 bits for I,Q and 4 markers = 4.5 bytes;  $256/4.5 \approx 56$  MSamples). The maximum waveform length increases to 64 MSamples if the internal hardware markers are used, in this case the complete memory is available for I/Q data (B11 = 16 MSamples).

The minimum length of a waveform is 512 samples. If a waveform is shorter than this, it is automatically repeated until it reaches the minimum length.

# ARB Menu

The menu for setting the ARB can be opened either in the **Baseband** block or by using the MENU key under **Baseband**.

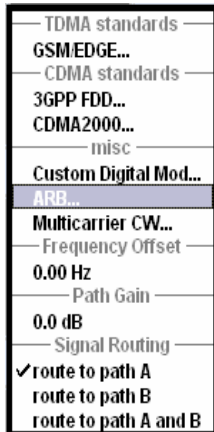

The **ARB** menu is divided into an upper and a lower general part together with a **Marker** section.

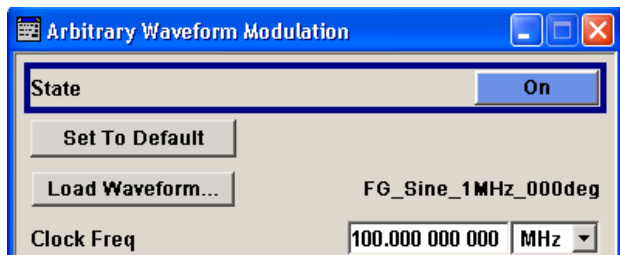

The upper part of the menu is used for powering up, selecting and configuring ARB modulation.

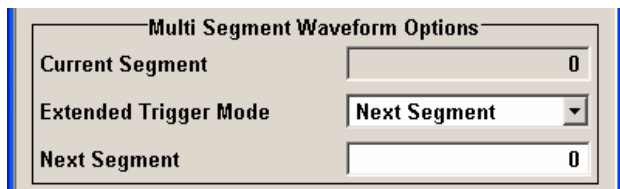

The **Multi-Segment Waveform Options** part is only indicated if a multi-segment waveform is loaded. In this part, the segment to be output is selected.



The buttons in the lower part of the menu open submenus for setting triggers and clocks, for configuring a sinusoidal test signal and for calculating a multi-segment waveform or a multi carrier waveform.

## ARB MOD Main Menu

The upper part of the menu is used for powering up, selecting and configuring ARB modulation.

### State - ARB

Enables/disables ARB modulation.

Switching on this standard turns off all the other digital standards and digital modulation types on the same path.

The output is based on the waveform file that is loaded. The name of the waveform file is displayed next to **Load Waveform**.

If a multi-segment waveform is loaded the **Multi-Segment Waveform Options** part is indicated. In this part, the segment to be output is selected.

If no waveform file is loaded, ARB modulation cannot be powered up. **None** will be displayed next to **Load Waveform**. An error message asks the user to load a waveform file:

**No waveform file loaded. ARB MOD state remains off. Please select a waveform file to load, before switching ARB MOD state on.**

Remote-control command:

SOUR:BB:ARB:STAT ON

### Set To Default - ARB

Calls default settings. The values are shown in the following table.

Remote-control commands:

SOUR:BB:ARB:PRES

Parameter	Value
State	Off
<b>Trigger</b>	
Mode	Auto
Source	Internal
Ext. Delay	0
Ext. Inhibit	0
<b>Trigger Signal</b>	
Mode	Auto
Source	Internal
External Delay	0
Inhibit	0
<b>Marker Signal</b>	
State	Off
CH. 1 Mode	Restart
CH. 2 Mode	Restart
CH. 3 Mode	Restart
CH. 4 Mode	Restart
Shift in Samples	0

Parameter	Value
Pulse Frequency	1 kHz
Pattern	'0'
ON/OFF ratio	1.1
<b>Clock</b>	
Frequency	1 MHz
Source	Intern
Delay	0
<b>Sine Signal</b>	
Frequency	1 kHz
Samples per Period	100
Phase Offset	90 DEG

**Load Waveform - ARB**

Calls the **File Select** menu for loading the waveform file.

The files last used are listed in the **Recent Data Sets** section. The directory can be selected from the center left section. All waveform files (file extension \*.wv) available from the selected directory are listed on the right side. The file info (tag contents and multi-segment state) for the selected file is displayed below the file section.

The **Select...** button selects the marked file. This file is loaded when the ARB modulation is enables (**State On**)

The **File Manager...** button leads to the file manager (see chapter 3).

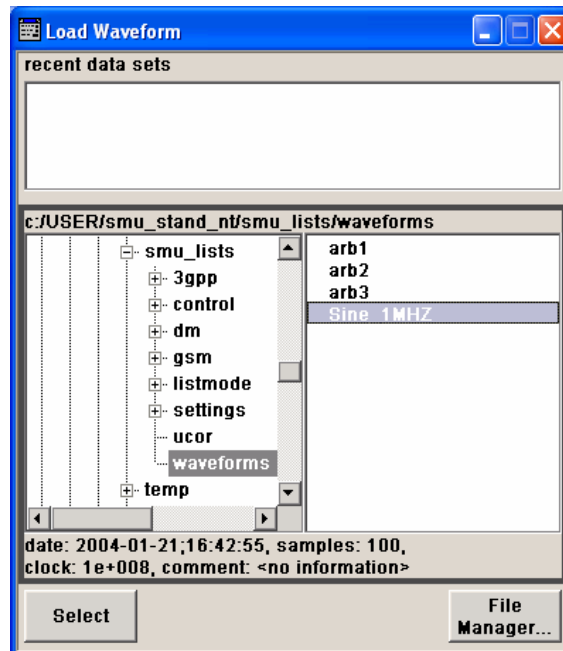

Remote-control command:

Example for a file in the default directory:

```
SOUR:BB:ARB:WAV:SEL 'Wave1'
```

Example for a file in a different directory:

```
SOUR:BB:ARB:WAV:SEL 'd:\user\wave\Wave1.wv'
```

**Clock Frequency - ARB**

Displays or enters the ARB output clock rate.

When the waveform file is loaded, this value is automatically set to the clock rate defined in the file (Clock tag). The user can subsequently alter the value if necessary.

When intending to work with an external clock source, the frequency to be applied must be entered here.

Remote-control command:

SOUR:BB:ARB:CLOC 10 MHz

The **Multi-Segment Waveform Options** part of the menu is only displayed if a multsegment waveform is loaded.

**Current Segment - ARB**

Indication of the waveform segment that is currently output.

Remote-control command:

SOUR:BB:ARB:WSEG



### Extended Trigger Mode - Multi Waveform ARB

Sets the extended trigger mode in the case of a multisegment waveform.. Extended trigger mode defines how the switch between segments will take place:

When **Same Segment** and **Next Segment** are selected, the current segment ceases to be output as soon as a new segment is entered in **Next Segment**, and the new segment starts to be output after a system-imposed signal gap.

The following figure shows an example of the transition from a sinewave signal segment to a sawtooth segment (I channel, above) in the case of external triggering (below).

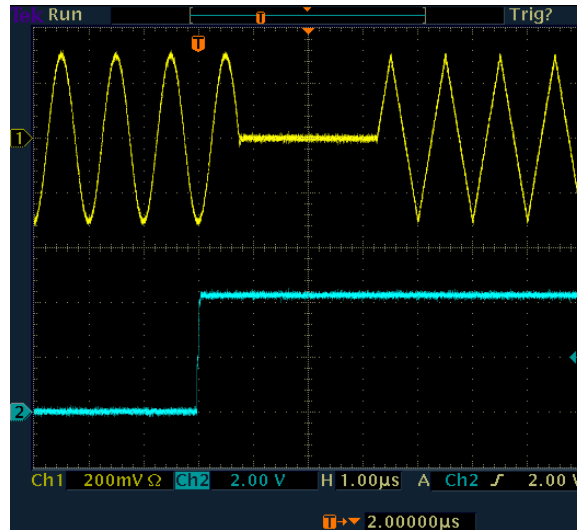

When **Next Segment Seamless** is selected and a new segment is entered in **Next Segment**, the new segment is not output until the whole of the current segment has been output (wrap around). In this case the signal transition is seamless (see **Next Segment Seamless**). A seamless switchover is only possible in the case of segments that have the same sample rate.

The following figure shows an example of the seamless transition from a sinewave signal segment to a sawtooth segment (I channel, above) in the case of external triggering (below).

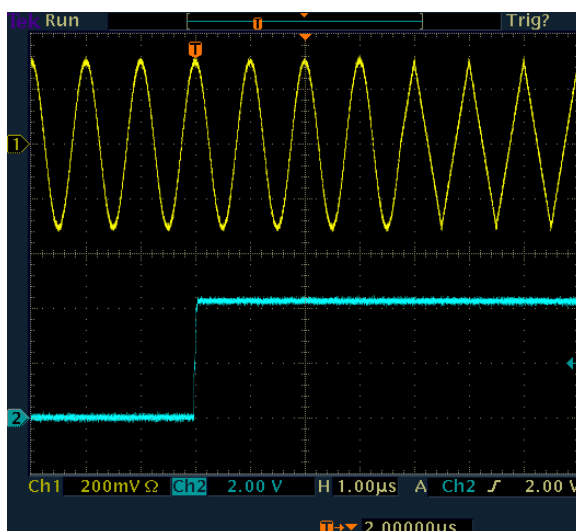

Extended trigger mode also defines the sequence in which segments will be output:

When **Internal Trigger Source** is selected it is possible to switch to any other segment by changing the entry in **Next Segment**. By selecting **Extended Trigger Mode** it is possible to define whether the new segment is generated immediately or only after the previous segment has been fully generated (wrap around).

Likewise when **External Trigger Source** is selected it is possible to switch to any other segment by changing the entry in **Next Segment**. It is also possible to scroll sequentially to the next available segment in the waveform by activating a trigger. The segment currently being output is displayed at **Current Segment**. The next trigger event after the last segment causes the first segment to be output again. By selecting **Extended Trigger Mode** it is possible to define whether the new segment is generated immediately or only after the previous segment has been fully output (wrap around).

When a multisegment waveform is loaded, generation of the signal starts at the segment defined in **Next Segment**.

The trigger settings in the **Trigger, Marker, Clock** submenu are similarly active. The possible combinations for the two trigger modes are specified in detail in the parameter description below.

- Same Segment** Depending on the trigger setting, the currently selected segment is continuously output either immediately or after a trigger event.
- Signal generation takes place differently according to the trigger selected in the Trigger menu:
- In the case of **Trigger = Auto**, output starts at once and the segment is generated continuously. Trigger events are ignored.
- If the segment is changed in **Next Segment**, output of the current segment is stopped and the new segment is output immediately, following a system-imposed signal gap (see above).
- In the case of **Trigger = Armed\_Auto**, output starts after the first trigger event. The segment is then generated continuously. Further trigger events are ignored.
- If the segment is changed in **Next Segment**, signal output is stopped and the new segment is not output until a trigger occurs.
- In the case of **Trigger = Retrigger**, output starts at once and the segment is generated continuously, a trigger event causes a restart.
- If the segment is changed in **Next Segment**, output of the current segment is stopped and the new segment is output immediately, following a system-imposed signal gap (see above).
- In the case of **Trigger = Armed\_Retrigger**, output starts after the first trigger event. The segment is then generated continuously. Further trigger events cause a restart.
- If the segment is changed in **Next Segment**, signal output is stopped and the new segment is not output until a trigger occurs.
- In the case of **Trigger = Single**, output starts after the first trigger event. The segment is then generated once. Further trigger events cause a restart.
- If the segment is changed in **Next Segment**, signal output is not stopped. The new segment is not output until a trigger occurs.
- Remote-control command:  
SOUR:BB:ARB:TRIG:SMOD SAME
- Next Segment** Depending on the trigger setting, the segment selected under **Next Segment** is output either immediately or after a trigger event.
- In the case of **internal Trigger = Auto**, output starts at once and the segment is generated continuously. Trigger events are ignored.
- If the segment is changed in **Next Segment**, output of the current segment is stopped and the new segment is output immediately, following a system-imposed signal gap (see above).

In the case of **internal Trigger = Armed\_Auto**, output starts after the first trigger event. The segment is then generated continuously. Further trigger events are ignored.

If the segment is changed in **Next Segment**, signal output is stopped and the new segment is not output until a trigger occurs.

In the case of **internal Trigger = Single**, output starts after the first trigger event. The segment is then generated once. Further trigger events cause a restart.

If the segment is changed in **Next Segment**, signal output is not stopped. The new segment is not output until a trigger occurs.

In the case of **External Trigger = Auto**, output starts at once and the segment is generated continuously. Each trigger event switches over to outputting the next segment. In this case there is a system-imposed signal gap (see above). The segment currently being output is displayed at **Current Segment**. The next trigger event after the last segment causes the first segment to be output again.

If the segment is changed in **Next Segment**, output of the current segment is stopped and the new segment is output immediately, following a system-imposed signal gap (see above).

In the case of **External Trigger = Armed\_Auto**, output starts after the first trigger event. The segment is then generated continuously. Each trigger event switches over to outputting the next segment. In this case there is a system-imposed signal gap (see above). The segment currently being output is displayed at **Current Segment**. The next trigger event after the last segment causes the first segment to be output again.

If the segment is changed in **Next Segment**, signal output is stopped and the new segment is not output until a trigger occurs.

In the case of **External Trigger = Single**, output starts after the first trigger event. The segment is then generated once. Each trigger event switches over to outputting the next segment once. The segment currently being output is displayed at **Current Segment**. The next trigger event after the last segment causes the first segment to be output again.

If the segment is changed in **Next Segment**, signal output is not stopped. The new segment is not output until a trigger occurs.

The remaining trigger modes (**Retrigger** and **Armed\_Retrigger**) are not available.

Remote-control command:

```
SOUR:BB:ARB:TRIG:SMOD NEXT
```

**Next Segment Seamless** The segment selected under **Next Segment** is output.

This mode is only available if all segments have the same sample rate.

In the case of **Internal Trigger = Auto**, output starts at once and the segment is generated continuously. Trigger events are ignored.

If the segment is changed in **Next Segment**, the new segment is output seamlessly after the output of the current segment is complete.

In the case of **internal Trigger = Armed\_Auto**, output starts after the first trigger event. The segment is then generated continuously. Further trigger events are ignored.

If the segment is changed in **Next Segment**, signal output is stopped and the new segment is not output until a trigger occurs.

In the case of **External Trigger = Auto**, output starts at once and the segment is generated continuously.

Each trigger event switches over to outputting the next segment once the output of the current segment has been completed. In each case segment currently being output is displayed at **Current Segment**. The next trigger event after the last segment causes the first segment to be output again.

If the segment is changed in **Next Segment**, the new segment is output seamlessly after the output of the current segment is complete.

In the case of **External Trigger = Armed\_Auto**, output starts after the first trigger event. The segment is then generated continuously. Each trigger event switches over to outputting the next segment once the output of the current segment has been completed. The segment currently being output is displayed at **Current Segment**. The next trigger event after the last segment causes the first segment to be output again.

If the segment is changed in **Next Segment**, signal output is stopped and the new segment is not output until a trigger occurs.

The remaining trigger modes (**Retrigger**, **Armed\_Retrigger** and **Single**) are not available.

Remote-control command:

```
SOUR:BB:ARB:TRIG:SMOD NSE
```

**Next Segment - ARB**

Selects the waveform segment to be output next. It determines the start segment when switching on the ARB.

For an **internal trigger source**, switchover to any segment is performed by changing the entry at **Next Segment**. Depending on the selected **Extended Trigger Mode** the new segment is output either at once or only after the complete output (wrap around) of the previous segment.

For an **external trigger source**, switchover to any segment is also performed by changing the entry at **Next Segment**. In addition, consecutive switchover to the next segment is performed on the occurrence of each trigger event. The currently output segment is indicated at **Current Segment**. When the last segment of the multisegment waveform has been output, the sequence starts again with the output of the first segment after the next trigger event.. Depending on the selected **Extended Trigger Mode** the new segment is output either at once or only after the complete output (wrap around) of the previous segment.

Remote-control command:

```
SOUR:BB:ARB:WSEG:NEXT 1
```

The lower part of the menu is used for setting triggers and clocks, as well as for file management. A simple sinewave signal can also be output for test purposes.

**Trigger/Marker - ARB**

Calls the Trigger and Marker menu.

This menu is used to select the trigger source, set the time delay on an external trigger signal and configure the marker output signals (see section "[Trigger/Marker/Clock - ARB MOD Menu](#)", page 4.219).

Remote-control command: n.a.

**Execute Trigger - ARB**

Executes trigger manually. A manual trigger can be executed only when an internal trigger source and a trigger mode other than Auto are selected.

Remote-control commands:

```
SOUR:BB:ARB:TRIG:SOUR INT
```

```
SOUR:BB:ARB:SEQ RETR
```

```
SOUR:BB:ARB:TRIG:EXEC
```

**Clock - ARB**

Calls the Clock menu. The Clock menu is used to select the clock source (see section "[Trigger/Marker/Clock - ARB MOD Menu](#)", page 4.219).

Remote-control command: n.a.

**Sine Testsignals - ARB** Calls the menu for generating sinusoidal test signals (see section "[Sine Test Signals - ARB MOD Menu](#)" page 4.227).  
Remote-control command: n.a.

**Multi-Segment - ARB** Calls the menu for calculating multi-segment waveforms (see section "[Create Multi-Segment Waveforms - ARB Menu](#)" page 4.228).  
Remote-control command: n.a.

**Multi-Carrier - ARB** Calls the menu for calculating multi-carrier waveforms (see section "[Create Multi-Carrier Waveforms - ARB Menu](#)" page 4.234).  
Remote-control command: n.a.

## Trigger/Marker/Clock - ARB MOD Menu

The **Trigger/Marker/Clock** menu is used to enter settings for triggers and markers, and to select the clock source. The menu offers internal triggering as well as the two external trigger inputs TRIGGER 1 and 2, and in the case of two-path instruments it also offers internal triggering by the second path. . The Trigger menu is accessed via the **ARB MOD** main menu.

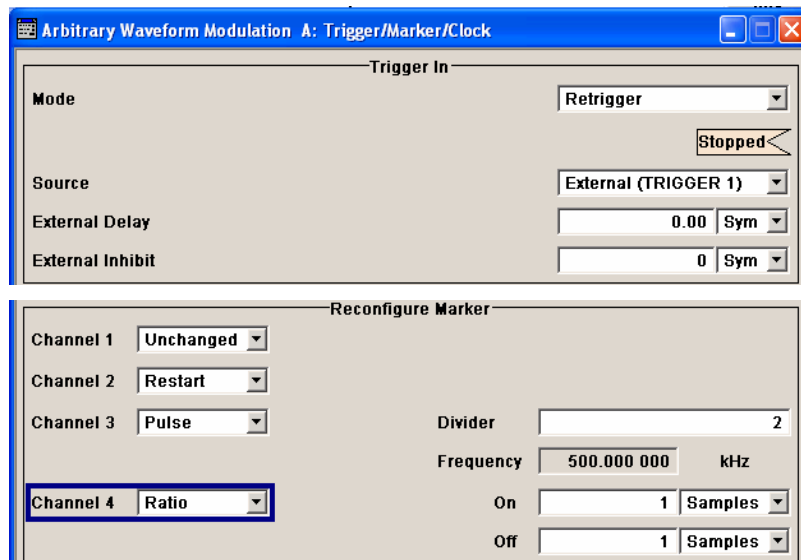

The **Trigger In** section is where the trigger for the waveform is set. Various parameters will be provided for the settings, depending on which trigger source - internal or external - is selected. The current status of signal output (**Running** or **Stopped**) is indicated for all trigger modes.

In the **Marker Mode** section markers can be defined in addition to the marker settings already defined in the waveform file.

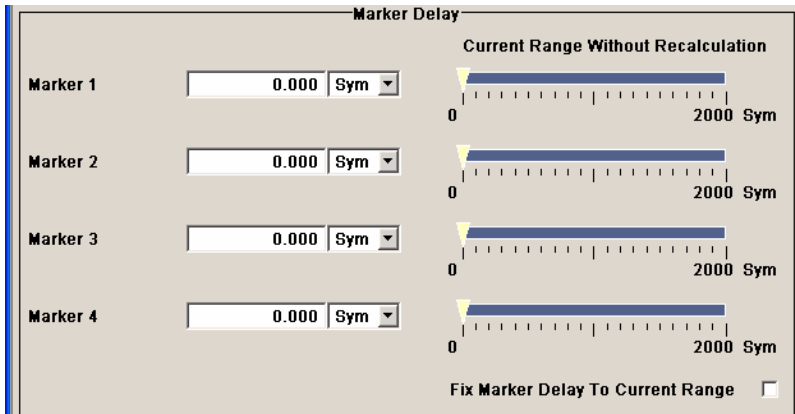

The **Marker Delay** section is where a marker signal delay can be defined, either without restriction or restricted to the dynamic section, i.e., the section in which it is possible to make settings without restarting signal and marker output.

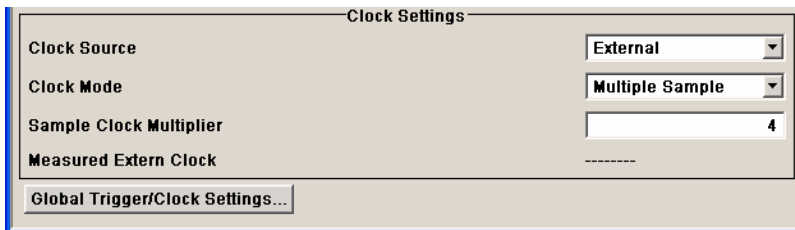

The **Clock Settings** section is where the clock source is selected and - in the case of an external source - the clock type.

The **Global Trigger/Clock Settings** button leads to a submenu for general trigger, clock and external input settings.

The **Trigger In** section is used to configure the trigger signal for the ARB modulation. The current status of waveform output is indicated for all trigger modes.

**Trigger Mode - ARB**

Selects trigger mode.

For multi-segment waveforms, signal output is determined by the Extended Trigger Mode also (see main menu)

**Auto**

The waveform or segment is output continuously. Signal output starts immediately when ARB modulation is enabled, trigger events are ignored.

Remote-control command:  
SOUR:BB:ARB:SEQ AUTO

**Retrigger**

The waveform output continuously. Signal output starts immediately when ARB modulation is enabled, a trigger event (internal or external) causes a restart.

Remote-control command:  
SOUR:BB:ARB:SEQ RETR

**Armed\_Auto**

The waveform is output only when a trigger event occurs. Then the waveform is output continuously. Subsequent trigger events are ignored

Button **Arm** stops waveform output. A subsequent trigger event (internal with **Execute Trigger** or external) causes a restart.

Remote-control command:  
SOUR:BB:ARB:SEQ AAUT



**Armed\_Retrigger** The waveform is output only when a trigger event occurs. Then the waveform is output continuously. Every subsequent trigger event (internal with **Execute Trigger** or external) causes a restart.

Button **Arm** stops waveform output. A subsequent trigger event (internal with **Execute Trigger** or external) causes a restart.

Remote-control command:

SOUR:BB:ARB:SEQ ARET

### Single

The waveform is output only when a trigger event occurs. Then the waveform is output once in the length specified in **Signal Duration**. Every subsequent trigger event (internal with **Execute Trigger** or external) causes a restart.

Remote-control command:

SOUR:BB:ARB:SEQ SING

**Signal Duration Unit - ARB** Defines the unit for the entry of the length of the signal sequence to be output in the **Single** trigger mode. Available units are samples or sequence length (SL).

Remote-control commands:

SOUR:BB:ARB:TRIG:SLUN SAMP

**Signal Duration - ARB** Enters the length of the signal sequence to be output in the **Single** trigger mode. The unit of the entry is defined under **Signal Duration Unit**. It is possible to output deliberately just part of the waveform, an exact sequence of the waveform, or a defined number of repetitions of the waveform.

Remote-control commands:

SOUR:BB:ARB:TRIG:SLLEN 2

**Running - Stopped - ARB** Displays the status of waveform output for all trigger modes.

Remote-control command:

SOUR:BB:ARB:TRIG:RMOD?

Response: RUN or STOP

**Running** The waveform is output; a trigger was (internally or externally) initiated in triggered mode.

For selection **Armed\_Auto** and **Armed\_Retrigger** waveform output can be stopped with button **Arm**. A subsequent trigger event (internal with **Execute Trigger** or external) causes a restart.

**Stopped** Waveform output is stopped. The instrument waits for an internal or external trigger event to restart or ARB modulation is disabled (**State Off**).

**Arm - ARB** Stops waveform output. This button appears only with **Running** signal output in the **Armed\_Auto** and **Armed\_Retrigger** trigger modes.  
Signal output can be restarted by a new trigger (internally with **Execute Trigger** or externally).

Remote-control command:  
SOUR:BB:ARB:TRIG:ARM:EXEC

**Execute Trigger - ARB** Executes trigger manually. A manual trigger can be executed only when an internal trigger source and a trigger mode other than Auto have been selected.

Remote-control commands:  
SOUR:BB:ARB:TRIG:SOUR INT  
SOUR:BB:ARB:SEQ RETR  
SOUR:BB:ARB:TRIG:EXEC

**Trigger Source - ARB** Selects trigger source.

**Internal** The trigger event is executed by **Execute Trigger**. As a precondition a trigger mode other than **Auto** must be selected.

Remote-control command:  
SOUR:BB:ARB:TRIG:SOUR INT

**Internal (Baseband A/B)** The trigger event is executed by the trigger signal from the second path (two-path instruments only), depending on their setting. This makes it possible for instance to start the two paths synchronously or with a defined delay.

Remote-control command:  
SOUR:BB:ARB:TRIG:SOUR OBAS

**External (TRIGGER 1|2)** The trigger event is executed with the aid of the active edge of an external trigger signal. The trigger signal is supplied via the TRIGGER 1 or TRIGGER 2 connector.

The polarity, the trigger threshold and the input impedance of the TRIGGER input can be set in the **Global Trigger Settings** menu.

---

**Note:**  
*For multisegment waveforms, an external trigger source can be used for cyclical output of the segments. Each trigger event start the output of the next segment. After the last segment, the first segment is output again.*

---

Remote-control command:  
SOUR:BB:ARB:TRIG:SOUR EXT | BEXT

**Trigger Delay - ARB**

Sets trigger signal delay in samples on external triggering or on internal triggering via the second path.

This enables the R&S Vector Signal Generator to be synchronized with the device under test or other external devices.

**Note**

*The delay can be set separately for each of the two paths.*

**Remote-control command:**

```
SOUR:BB:ARB:TRIG:EXT:DEL 0
SOUR:BB:ARB:TRIG:OBAS:DEL 0
```

**Trigger Inhibit - ARB**

Sets the duration for inhibiting a new trigger event subsequent to triggering. The input is to be expressed in samples.

In the **Retrigger** mode every trigger signal causes signal output to restart. This restart is inhibited for the specified number of samples:

This parameter is only available on external triggering or on internal triggering via the second path.

**Note:**

*The trigger inhibit can be set separately for each of the two paths.*

**Remote-control command:**

```
SOUR:BB:ARB:TRIG:EXT:INH 0
SOUR:BB:ARB:TRIG:OBAS:INH 0
```

In the **Marker Mode** section markers can be defined in addition to the marker settings already defined in the waveform file.

**Marker x - ARB**

Selects a marker signal on the MARKER outputs.

**Note:**

*The marker trace in the waveform file remains unchanged in every case. It is not overwritten, even in the case of a selection other than **Unchanged**.*

**Unchanged**

The marker signal remains unchanged as defined in the waveform file.

**Remote-control command:**

```
SOUR:BB:ARB:TRIG:OUTP1:MODE UNCH
```

**Restart**

A brief marker signal is generated at the start of the waveform or segment.

**Remote-control command:**

```
SOUR:BB:ARB:TRIG:OUTP1:MODE REST
```

**Pulse**

A regular marker signal is generated. The pulse frequency is defined by entering a divider. The frequency is derived by dividing the sample rate by the divider. The input box for the divider opens when **Pulse** is selected, and the resulting pulse frequency is displayed below it.

The precision of the frequency setting depends on the sampling rate. The maximum pulse frequency is equal to half of the sampling rate.

Divider	2
Frequency	500.000 000 kHz

Remote-control command:

```
SOUR:BB:ARB:TRIG:OUTP1:MODE PULS
SOUR:BB:ARB:TRIG:OUTP1:PULS:DIV 4
SOUR:BB:ARB:TRIG:OUTP1:PFR?
```

**Pattern**

A marker signal that is defined by a bit pattern is generated. The pattern has a maximum length of 32 bits and is defined in an input field which opens when **pattern** is selected.

1 1111 1111 1111 1111
-----------------------

The pattern bits switch the marker signal to high and low state.

Remote-control command:

```
SOUR:BB:ARB:TRIG:OUTP1:MODE PATT
SOUR:BB:ARB:TRIG:OUTP1:PATT #B11001,5
```

**ON/OFF ratio**

A regular marker signal that is defined by an ON/OFF ratio is generated. A period lasts one ON and OFF cycle.

Start of signal

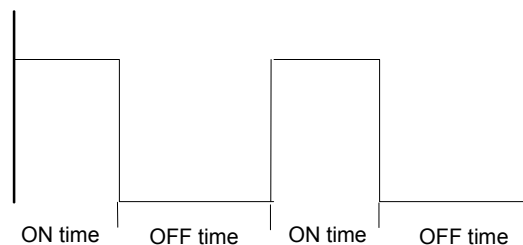

The ON time and OFF time are each expressed as a number of samples and are set in an input field which opens when **ON/OFF ratio** is selected.

On Time	20	Samples
Off Time	30	Samples

Remote-control command:

```
SOUR:BB:ARB:TRIG:OUTP1:MODE RAT
SOUR:BB:ARB:TRIG:OUTP1:OFFT 30
SOUR:BB:ARB:TRIG:OUTP1:ONT 20
```

The delays for the marker output signals are entered in the **Marker Delay** section.

**Marker x Delay - ARB** Enters the delay between the marker signal at the marker outputs and the start of the signal.

The input is expressed as a number of samples. If the setting "**Fix marker delay to dynamic range**" is enabled, the setting range is restricted to the dynamic range. In this range the delay of the marker signals during signal output can be set without restarting the marker and signal.

Remote-control command:

SOUR:BB:ARB:TRIG:OUTP2:DEL 2

**Current Range without Recalculation - ARB** Displays the dynamic range within which the delay of the marker signals can be set without restarting the marker and signal.

Remote-control command:

SOUR:BB:ARB:TRIG:OUTP2:DEL:MAX?

SOUR:BB:ARB:TRIG:OUTP2:DEL:MIN?

**Fix marker delay to current range - ARB** Restricts the marker delay setting range to the dynamic range. In this range the delay can be set without restarting the marker and signal.

Remote-control command:

SOUR:BB:ARB:TRIG:OUTP:DEL:FIX ON

The **Clock Settings** section is used to select the clock source.

**Clock Source - ARB** Selects the clock source (also see section "[Clock Signals](#)", page 4.154).

**Internal** The internal clock reference is used to generate the sample clock.

Remote-control command:

SOUR:BB:ARB:CLOC:SOUR INT

**External** The external clock reference is fed in as the sample clock or multiple thereof via the CLOCK connector.

The polarity of the clock input can be changed with the aid of Global Trigger/Clock Settings.

In the case of two-path instruments this selection applies to path A.

Remote-control command:

SOUR:BB:ARB:CLOC:SOUR EXT

<b>Clock Mode - ARB</b>	Enters the type of externally supplied clock.
	<b>Sample</b> A sample clock is supplied via the CLOCK connector. Remote-control command: SOUR:BB:ARB:CLOC:MODE SAMP
	<b>Multiple</b> A multiple of the sample clock is supplied via the CLOCK connector; the sample clock is derived internally from this. The <b>Multiplier</b> window provided allows the multiplication factor to be entered. Remote-control command: SOUR:BB:ARB:CLOC:MODE MSAM
<b>Sample Clock Multiplier - ARB</b>	Enters the multiplication factor for clock type <b>Multiple</b> . Remote-control command: SOUR:BB:ARB:CLOC:MULT 4
<b>Measured External Clock - ARB</b>	Indicates the measured frequency of the external clock signal. Thus, screening of the external clock is possible. The frequency is only indicated when external clock source is selected. Remote-control command: CLOC:INP:FREQ?
<b>Global Trigger/Clock/Input Settings - ARB</b>	Calls the <b>Global Trigger/Clock/Input Settings</b> menu. This menu is used among other things for setting the trigger threshold, the input impedance and the polarity of the clock and trigger inputs. In the case of two-path instruments these settings are valid for both paths. The parameters in this menu affect all digital modulations and standards, and are described in the section " <a href="#">Global Trigger/Clock/Input Settings – Setup -Environment</a> ".

## Sine Test Signals - ARB MOD Menu

The **Sine Test Signals** menu is accessed via the **ARB MOD** main menu.

The menu can be used to configure a sinusoidal test signal. A sine wave is always generated on the I path, and optionally a sine wave of the same frequency but phase-shifted can be generated on the Q path.

The signal actually set is displayed in graphical form in the center of the menu.

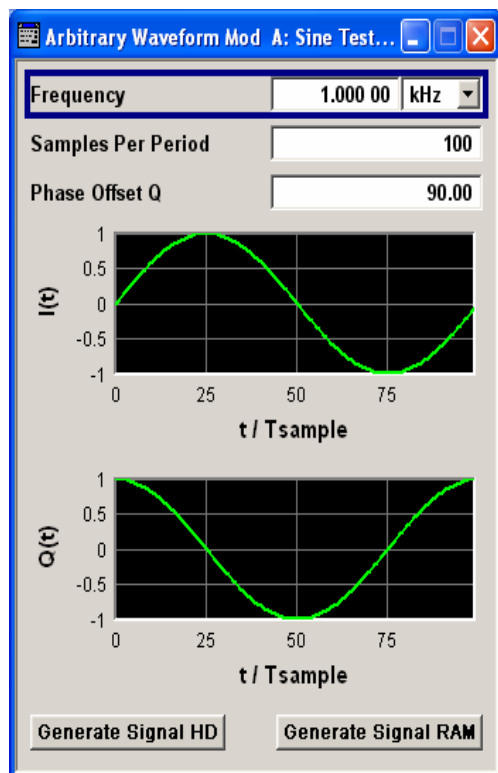

### Frequency - ARB

Enters the frequency of the test signal.

Remote-control command:

SOUR:BB:ARB:TSIG:SINE:FREQ 2 MHz

### Samples per Period - ARB

Enters the number of sample values required from the sine wave per period.

The resulting clock rate must not exceed the maximum ARB clock rate (100 MHz). The number of sample values is automatically restricted by reference to the set frequency.

Remote-control command:

SOUR:BB:ARB:TSIG:SINE:SAMP 35

- Phase Offset Q - ARB** Enters the phase offset of the sinewave signal on the Q channel relative to the sinewave signal on the I channel.  
Remote-control command:  
SOUR:BB:ARB:TSIG:SINE:PHAS 75DEG
- Generate Signal HD - ARB** Generates a signal and saves it to a file.  
The File Select window opens automatically and the signal can be stored as a waveform file.  
Remote-control command: n.a.
- Generate Signal RAM - ARB** Generates a signal and uses it as output straight away.  
Remote-control command: n.a.

## Create Multi-Segment Waveforms - ARB Menu

The **Multi-Segment...** menu is accessed via the **ARB** main menu.

The menu can be used to create a multisegment waveform from existing waveforms and save it under its own name. As with normal waveforms, the file extension is **\*.wv**. Information on whether a file is a multisegment waveform is displayed in the File menu with the tag information when a waveform is loaded.

If the combined waveforms have different sample rates, they can be adapted to a common sample rate by resampling. By the same procedure the instantaneous amplitude of the various waveforms can be scaled to a common rms level.

The configuration of a multisegment waveform, that is to say details of how it is made up from different waveforms, the level and clock rate settings, and the file name, can be saved separately in a list. The file extension is **\*.inf\_mswv**. This method can be used to create any number of configurations as a basis for defining further multisegment waveforms.

Example for the creation of a multi-segment waveform file.

1. Create empty list (**New List**)
2. Append two or more waveform files (**Append** or **Insert**)
3. Set level and clock mode (**Level** and **Clock**)
4. Enter file name (**Output File**)
5. Save configuration (**Save List**)
6. Save multi-segment waveform (**Create** or **Create and Load**)



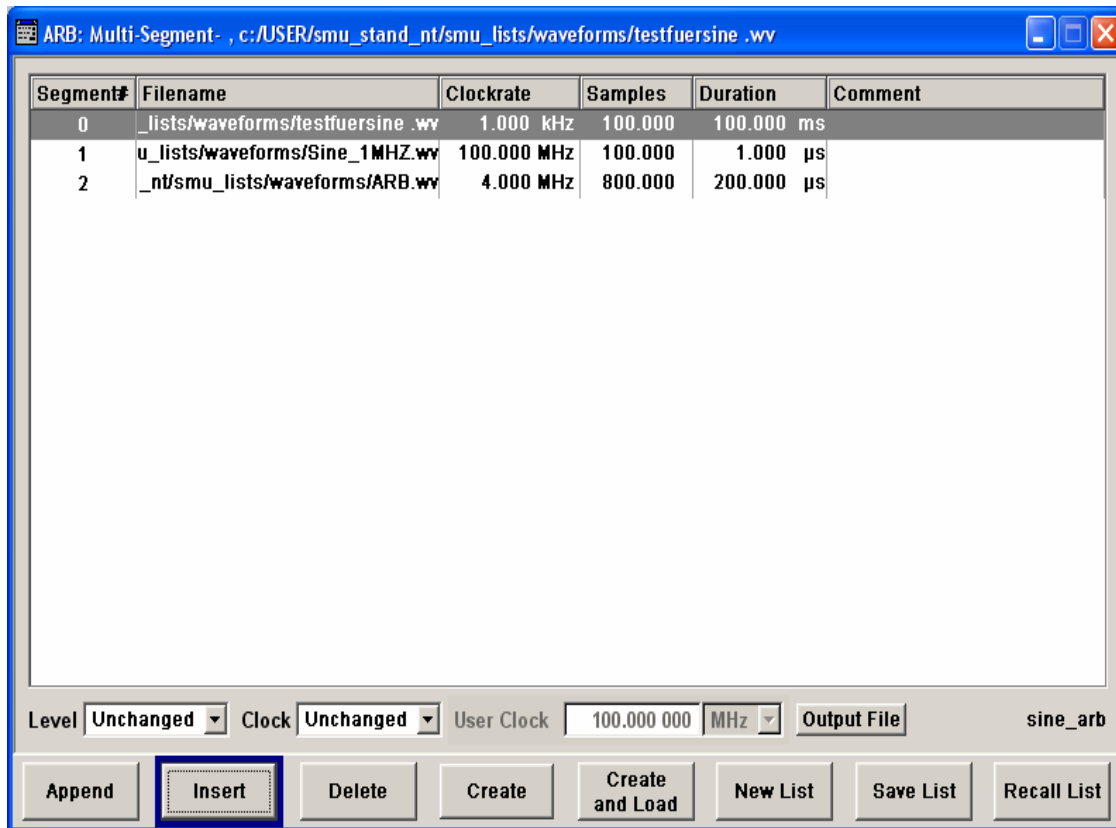

### Multi-Segment Table - Multi-Segment ARB

The table lists the individual waveforms (segments) of the selected multi-segment waveform. The information about the segments is taken from the tags of the corresponding waveform files.

<b>Segment #</b>	Indication of segment index. The segment index is used to select the segment to be output. The segment index also defines the sequence of the output during external triggering in the <b>Next Segment</b> or <b>Next Segment Seamless</b> trigger modes. Remote-control command: n.a.
<b>File Name</b>	Indication of the path and waveform file name of the segment. Remote-control command: n.a.
<b>Clock Rate</b>	Indication of the clock rate of the segment. The polarity of the clock input can be changed with the aid of <b>Global Trigger/Clock Settings</b> . Remote-control command: n.a.
<b>Duration</b>	Indication of the segment duration. Remote-control command: n.a.

**Samples** Indication of the number of samples in the segment.

Remote-control command: n.a.

**Comment** Indication of the comment on the segment

Remote-control command: n.a.

**Level - Multi-Segment ARB** Defines the level mode for the multisegment waveform.

**Unchanged** Segments are output exactly as defined in the files. The **Level** display applies only to the segment with the highest rms value. In some circumstances the remaining segments are output at a lower level than that displayed.

Remote-control command:

SOUR:BB:ARB:CONF:LEV:MODE UNCH

**Equal RMS** Segments are output so that all segments have the same rms value. The **Level** display applies to all segments.

Remote-control command:

SOUR:BB:ARB:CONF:LEV:MODE ERMS

**Clock - Multi-Segment ARB** Selects the clock rate mode for the multi-segment waveform.

**Unchanged** A segment is output with the clock rate defined in the file.

If segments have different clock rates, extended trigger mode **Next Segment** allows internal segment switchovers only (**Internal** trigger source).

Extended trigger mode **Next Segment Seamless** can only be selected if all segments have the same clock rate.

Remote-control command:

SOUR:BB:ARB:WSEG:CONF:CLOC:MODE UNCH

**Highest** All segments are output at the highest available clock rate.

This mode provides very short switchover times between segments.

The time for calculating the multisegment waveform is increased since the individual segments have to be resampled.

Remote-control command:

SOUR:BB:ARB:WSEG:CONF:CLOC:MODE HIGH

<b>User</b>	<p>All segments are output at the clock rate defined in <b>User Clock</b>.</p> <p>This mode provides very short switchover times between segments.</p> <p>The time for calculating the multisegment waveform is increased since the individual segments have to be resampled.</p> <p>Remote-control command  SOUR:BB:ARB:WSEG:CONF:CLOC:MODE USER</p>
<b>User Clock - Multi-Segment ARB</b>	<p>Defines the sample rate used for multisegment waveform output in case of Clock Mode <b>User</b>.</p> <p>Remote-control command:  SOUR:BB:ARB:WSEG:CONF:CLOC 50MHz</p>
<b>Output file - Multi-Segment ARB</b>	<p>Opens the <b>File</b> menu, where the file name of the multisegment waveform which has to be calculated can be entered.</p> <p>The multisegment waveform is saved under this name by clicking the <b>Create</b> or <b>Create and Load</b> button.</p> <p>A name must also be entered here before the list can be saved as a configuration file (<b>Save List</b>). In this case the name is needed for internal storage procedures. It is entered as the default name for the multisegment waveform file when loading the list.</p> <p>Remote-control command:  SOUR:BB:ARB:WSEG:CONF:OFIL "Multi1"</p>
<b>Append - Multi-Segment ARB</b>	<p>Opens the file menu to enter the file name of the waveform file to be appended.</p> <p>Remote-control command:  SOUR:BB:ARB:WSEG:CONF:SEGM:APP 'arb2'</p>
<b>Insert - Multi-Segment ARB</b>	<p>Opens the file menu to enter the file name of the waveform file to be inserted. The new waveform is inserted above the marked line.</p> <p>Remote-control command: n.a.</p>
<b>Delete- Multi-Segment ARB</b>	<p>Deletes the selected segment.</p> <p>Remote-control command: n.a.</p>

**Create- Multi-Segment ARB** Creates a new multi-segment waveform using the current table entries.

This multi-segment waveform is saved with the file name specified in **Output File**. If no file name is specified, the File Manager opens so that the file name can be entered. As with normal waveforms, the file extension is **\*.wv**.

Depending on the configuration of the multisegment waveform, calculation may take some time. A panel with a progress bar and an **Abort** button appears during creating of the multi-segment waveform.

Remote-control command:

```
SOUR:BB:ARB:WSEG:CRE "conf_16"
```

(in remote control the configuration file to be used for the creation of the multisegment waveform is defined with command

```
SOUR:BB:ARB:WSEG:CRE or SOUR:BB:ARB:WSEG:CLO. The file name of the waveform file is always determined with command
```

```
SOUR:BB:ARB:WSEG:CONF:OFIL 'wv_name')
```

**Create and Load- Multi-Segment ARB**

Creates a new multi-segment waveform using the current table entries.

This multi-segment waveform is saved with the file name specified in **Output File**. If no file name is specified, the File Manager opens so that the file name can be entered. As with normal waveforms, the file extension is **\*.wv**.

Depending on the configuration of the multisegment waveform, calculation may take some time.

Following this the **Create Multi-Segment Waveform File** submenu is closed and the new multisegment waveform is loaded. The digital standard **ARB** is activated and the first segment of the waveform is output in accordance with the trigger settings.

Remote-control command:

```
SOUR:BB:ARB:WSEG:CLO "conf_16"
```

(in remote control the configuration file to be used for the creation of the multisegment waveform is defined with command

```
SOUR:BB:ARB:WSEG:CRE or SOUR:BB:ARB:WSEG:CLO. The file name of the waveform file is always determined with command
```

```
SOUR:BB:ARB:WSEG:CONF:OFIL 'wv_name')
```

**New List- Multi-Segment ARB**

Deletes all entries of the table. A new configuration table is created.

Remote-control command:

```
SOUR:BB:ARB:WSEG:CONF:SEL "new_mseg"
```

**Save List- Multi-Segment  
ARB**

Saves the current entries of the table in a configuration file, including the level mode, clock mode and output file name settings.

The file name is entered in the **File** menu. Configuration files have the file extension **\*.inf\_mswv**. They can be used later as the basis for further multisegment waveforms.

Before a multisegment configuration file can be saved, a file name must be entered in **Output File**, since this is saved with the configuration file for internal purposes. This file name is also used as the default name for the multisegment waveform when loading the configuration file.

Remote-control command: n.a.

(in remote control the configuration file to be used for the creation of the multisegment waveform is defined with command

SOUR:BB:ARB:WSEG:CRE or SOUR:BB:ARB:WSEG:CLO. The file name of the waveform file is always determined with command SOUR:BB:ARB:WSEG:CONF:OFIL 'wv\_name')

**Recall List- Multi-Segment  
ARB**

Opens the file menu to select the configuration file to be edited.

Remote-control command:

SOUR:BB:ARB:WSEG:CONF:SEL "multi\_seg2"

## Typical Applications for Multisegment Waveforms - ARB Menu

### High Speed Switchovers

To test DUTs/chips using different test signals at high throughput requires extremely fast switchovers (for instance when testing ATE devices during manufacture). The following settings enable switching times of approx. 5  $\mu$ s and the test signals are scrolled through with the aid of an external trigger signal.

**Trigger Mode = Auto**

**Trigger Source = External Trigger 1 or 2**

If the waveforms have different sample rates:

**Clock Mode = Highest or User** (when creating the waveform in the Multisegment Editor)

### Flexible Dynamic Switchovers

When testing DUTs using different test signals, it may be necessary to switch dynamically and flexibly between any of the test signals, for instance depending on the outcome of the previous test. When using remote control via an external computer, the following settings enable switching times of approx. 20 ms for segments with the same sample rate and approx. 200 ms for segments with different sample rates.

**Extended Trigger Mode = Next Segment**

**Trigger Mode = Auto**

**Trigger Source = Internal**

### Flexible Dynamic Switchovers without Signal Interruptions

Testing receivers requires a continuous output of different test signals without interrupting the signal. The test signals then produce a complex total signal with no signal gaps on switchover. Control procedures can use a simulated back channel of the receiver (trigger line or remote control).

Switching times depend on the length of the segment currently being output, since switchover to the next segment does not take place until the current segment comes to an end.

### Extended Trigger Mode = Next Segment Seamless

**Trigger Mode = Auto**

**Trigger Source = Internal or External**

If the waveforms have different sample rates:

**Clock Mode = Highest or User** (when creating the waveform in the Multisegment Editor)

## Create Multi-Carrier Waveforms - ARB Menu

The **Multi-Carrier...** menu is accessed via the **ARB** main menu.

The menu can be used to create a multi-carrier waveform and save it under its own name. As with normal waveforms, the file extension is \*.wv. Information on clock rate, number of samples and creation day is displayed in the File menu when a waveform is loaded.

Multi-carrier waveforms of up to 32 modulated carriers can be configured. The carriers are equally spaced and centered toward the RF frequency or baseband DC line, respectively. The carrier spacing is adjustable within the total available baseband bandwidth of 80 MHz. Each carrier can be separately defined in terms of power, phase and modulated input signal. Optionally, crest factor optimization can be applied.

Thus, multi-carrier waveforms can be very easily configured as broadband test signals and used for such purposes as transmitter or receiver tests. In addition. Even complex multi-carrier scenarios composed of signals from different digital standards can be created and used for these tests.

Example for the creation of a multi-carrier waveform file.

1. Configure general settings
2. Configure carrier table
3. Enter file name of multi-carrier waveform (**Output File**)
4. Save and load multi-carrier waveform (**Create** or **Create and Load**)

## ARB Multi-Carrier Submenu

The **Multi-Carrier** submenu is divided into the following sections.



The upper part of the menu is used for calling the default settings and saving and recalling the submenu settings.

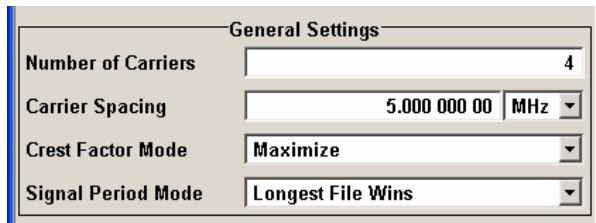

The **General Settings** section is used to configure the main multi-carrier waveform.



The buttons in the middle part of the menu open submenus for defining the carrier table. The carrier settings can be checked in the graphical **Carrier Graph** submenu.

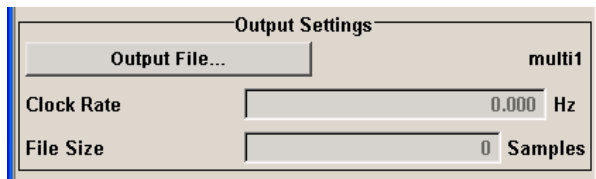

The **Output Settings** section indicates the name, the size and the clock rate of the multi-carrier waveform (after calculation).

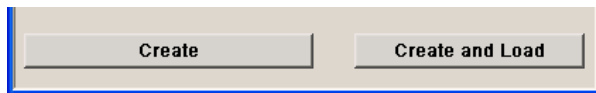

The buttons in the lower part of the menu activate creation and optionally loading of multi-carrier waveform files into the main ARB menu.

The upper part of the menu is used for calling the default settings and saving and recalling existing ARB multi-carrier submenu settings.

### Set to Default - ARB Multi-Carrier

Calls default settings. The values are shown in the following table.

Remote-control command:  
 SOUR : BB : ARB : MCAR : PRES

Parameter	Value
General Settings	
Number of Carriers	1
Carrier Spacing	0 MHz
Crest Factor Mode	Off
Signal Period Mode	Longest file wins

**Save/Recall Frame - ARB  
Multi-Carrier**

Calls the **Save/Recall** menu.

From the **Save/Recall** menu the **File Select** windows for saving and recalling the configurations of the ARB **Multi-Carrier** submenu and the **File Manager** can be called.



Remote-control command:

```
SOUR:BB:ARB:MCAR:SETT:CAT?
```

```
SOUR:BB:ARB:MCAR:SETT:LOAD 'M_carr1'
```

```
SOUR:BB:ARB:MCAR:SETT:STORLOAD 'M_carr2'
```

The **General Settings** section is used to configure the Multi-Carrier signal.

**Number of Carriers - ARB  
Multi-Carrier**

Sets the number of carriers for the multi-carrier waveform.

By default the multi-carrier table lists 1 carrier. A maximum of 32 carriers can be configured and activated.

When the number of carriers is increased, the multi-carrier table is extended by adding further lines at the end of the table. If these carrier already have been defined before, the settings are preset according to the former settings. Otherwise the parameters are preset with the default values.

Remote-control command:

```
SOUR:BB:ARB:MCAR:CARR:COUN 22
```



**Carrier Spacing - ARB  
Multi-Carrier**

Sets the frequency spacing between adjacent carriers of the multi-carrier waveform.

The carriers are arranged symmetrically around the RF carrier.

The maximum carrier spacing is limited to

$Carrier\ spacing = Total\ baseband\ bandwidth / (Number\ of\ carriers - 1);$

The total baseband bandwidth is 80 MHz.

**Note:**

*In order to avoid wrap-around problems, the effective **Carrier Spacing** might be slightly modified. The **Carrier Spacing** is rounded in that way that the carrier closest to the center RF frequency shows no phase jump assuming that the carrier is unmodulated.*

*For odd number of carriers:*

*$RoundedCarrierSpacing = 1 / OutputSignalDuration * round(CarrierSpacing * OutputSignalDuration);$*

*For even number of carriers:*

*$RoundedCarrierSpacing = 2 / OutputSignalDuration * round(0.5 * CarrierSpacing * OutputSignalDuration);$*

Remote-control command:

SOUR:BB:ARB:M CAR:CARR:SPAC 10 kHz

**Crest Factor Mode - ARB  
Multi-Carrier**

Selects the mode for optimizing the crest factor by calculating the carrier phases.

The crest factor represents the ratio of the peak voltage value to the rms voltage value. The higher the crest factor and resulting dynamics of a signal, the greater the requirement for a power amplifier fed by the signal to be linear.

The following modes are available:

**Off**

There is no automatic setting for minimizing or maximizing the crest factor. The **Phase** setting as defined in the carrier table is in use.

Remote-control command:

SOUR:BB:ARB:M CAR:CFAC:MODE OFF

**Minimize**

The crest factor is minimized by internally calculating optimized carrier phases. The Phase setting displayed in the carrier table is invalid. Remote-control

command:  
SOUR:BB:ARB:M CAR:CFAC:MODE MIN

**Maximize**

The crest factor is maximized by internally calculating optimized carrier phases. The Phase setting displayed in the carrier table is invalid.

Remote-control command:

SOUR:BB:ARB:M CAR:CFAC:MODE MAX

**Signal Period Mode - ARB Multi-Carrier**

Selects the mode for calculating the resulting signal period of the multi-carrier waveform. The carrier table provides an information button to obtain sample rate and file length data of each carrier.

The resulting period is always calculated for all carriers in the carrier table irrespective of their state (ON/OFF).

**Note:**

*Wrap-around and timing problems may occur when I/Q signals of different length are used. Thus, demodulation of a carrier may be difficult or even impossible. It is therefore recommended to consider the timing already when creating the input I/Q files or to adjust the signal duration to the carrier which is subsequently demodulated (in this case, the other carriers are for interfering the signal only). These problems do not arise with signals of the same standard (e.g. 3GPP).*

The following modes are available:

**Longest File Wins**

The resulting signal period is defined by the longest I/Q file in the carrier table. Shorter I/Q files are periodically repeated.

Remote-control command:

```
SOUR:BB:ARB:M CAR:TIME:MODE LONG
```

**Shortest File Wins**

The resulting signal period is defined by the shortest I/Q file in the carrier table. Only the first part of longer I/Q files is used.

Remote-control command:

```
SOUR:BB:ARB:M CAR:TIME:MODE SHOR
```

**User**

The signal period can be set by the user in the **Signal Period** field. Shorter I/Q files are repeated periodically, and only the first part of longer I/Q files is used.

Remote-control command:

```
SOUR:BB:ARB:M CAR:TIME:MODE USER
```

**Signal Period - ARB Multi-Carrier**

Sets the signal period in Signal Duration Mode **User**.

Remote-control command:

```
SOUR:BB:ARB:M CAR:TIME 1s
```

The buttons in the middle part of the menu open submenus for defining the carrier table. The carrier settings can be checked in the graphical **Carrier Graph** submenu. The **Carrier Table Assistant** section can be used to set a selectable carrier range.

**Carrier Table Submenu - ARB Multi-Carrier**

Calls the table for configuring individual carriers. A selectable carrier range can be set with the aid of the optional **Carrier Table Assistant**. The multi-carrier configuration can be checked with the aid of the **Carrier Graph**.

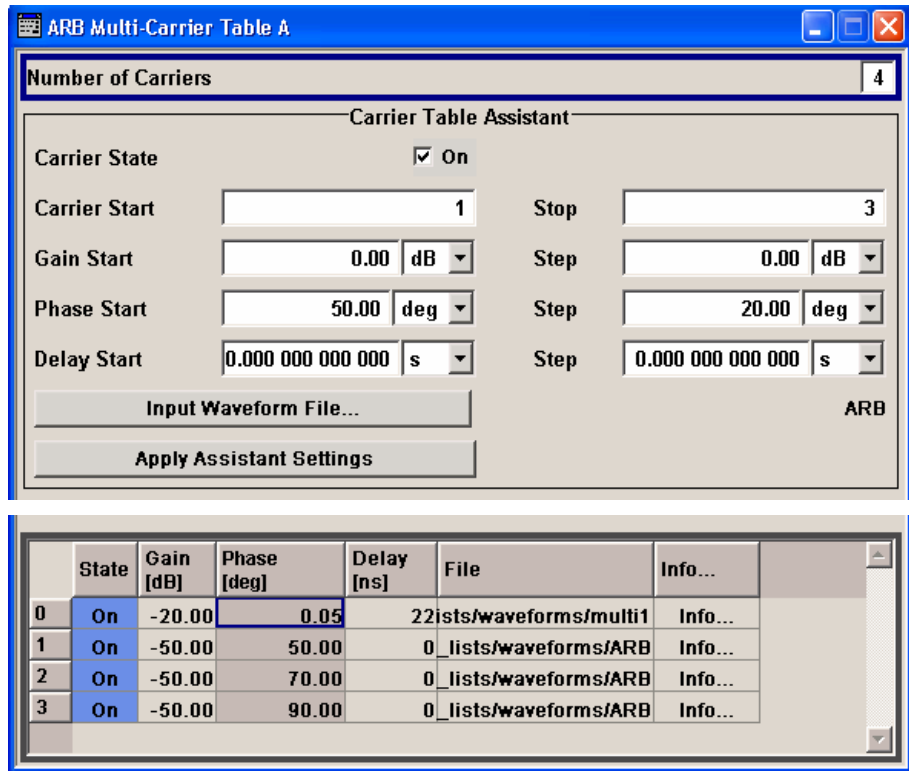

The **Carrier Table Assistant** serves as a optional mean to quickly set up a multi-carrier scenario within a specified carrier range.

**Number of Carriers - ARB Multi-Carrier**

Defines the number of carriers of the multi-carrier waveform. This parameter is identical to that in the **General Setting** section.  
Remote-control command:  
SOUR:BB:ARB:MCAR:COUN 22

**Carrier State - ARB Multi-Carrier**

Switches the carriers in the range **Carrier Start** to **Carrier Stop** on/off.  
Remote-control command:  
SOUR:BB:ARB:MCAR:EDIT:CARR:STAT ON

<b>Carrier Start - ARB Multi-Carrier</b>	<p>Defines the start index of the carrier range to which the assistant settings are intended to apply.</p> <p>Remote-control command: SOUR:BB:ARB:MCAR:EDIT:CARR:STAR 2</p>
<b>Carrier Stop - ARB Multi-Carrier</b>	<p>Defines the stop index of the carrier range to which the assistant settings are intended to apply.</p> <p>Remote-control command: SOUR:BB:ARB:MCAR:CARR:CARR:STOP 20</p>
<b>Gain Start - ARB Multi-Carrier</b>	<p>Sets the gain of the carrier marked by <b>Carrier Start</b>.</p> <p>Remote-control command: SOUR:BB:ARB:MCAR:EDIT:CARR:POW 0 dB</p>
<b>Gain Step - ARB Multi-Carrier</b>	<p>Sets the step width that is used to increment the gain</p> <p>The resulting carrier gain in the carrier table equals:</p> <p><i>GainStart + n* Gain Step</i></p> <p>where n ranges from 0 to (Carrier Stop – Carrier Start).</p> <p>Remote-control command: SOUR:BB:ARB:MCAR:EDIT:CARR:POW:STEP -0.2 dB</p>
<b>Phase Start - ARB Multi-Carrier</b>	<p>Sets the phase of the carrier marked by <b>Carrier Start</b>.</p> <p>Remote-control command: SOUR:BB:ARB:MCAR:EDIT:CARR:PHAS 0</p>
<b>Phase Step - ARB Multi-Carrier</b>	<p>Sets the step width that is used to increment the phase.</p> <p>The resulting phase in the carrier table equals:</p> <p><i>PhaseStart + n* PhaseStep</i></p> <p>where n ranges from 0 to (Carrier Stop – Carrier Start)</p> <p>Remote-control command: SOUR:BB:ARB:MCAR:EDIT:CARR:PHAS:STEP 1DEG</p>
<b>Delay Start - ARB Multi-Carrier</b>	<p>Sets the delay of the carrier marked by <b>Carrier Start</b>.</p> <p>Remote-control command: SOUR:BB:ARB:MCAR:EDIT:CARR:DEL 0</p>

**Delay Step - ARB Multi-Carrier**

Sets the step width that is used to increment the delay  
 The resulting delay in the carrier table equals:  
 $DelayStart + n * DelayStep$   
 where n ranges from 0 to (Carrier Stop – Carrier Start).  
 Remote-control command:  
 SOUR:BB:ARB:MCAR:EDIT:CARR:DEL:STEP 10us

**Input Waveform File - ARB Multi-Carrier**

Calls the **File** menu for selecting the inputfile with the I/Q signal to be modulated onto all carriers of the selected carrier range.  
 Remote-control command:  
 SOUR:BB:ARB:MCAR:EDIT:CARR:FILE "iq\_test"

**Apply Assistant Settings - ARB Multi-Carrier**

Transfer the assistant settings to the carrier table.  
 Remote-control command:  
 SOUR:BB:ARB:MCAR:EDIT:CARR:EXEC

**Carrier Table - ARB Multi-Carrier**

The table displays the settings of all available carriers. Previously applied assistant settings can be further refined. The number of lines corresponds to the number of carriers.

**Note:**  
*The phase/deg settings are only valid if optimization of the crest factor is disabled (Crest Factor Mode = Off).*

	State	Gain [dB]	Phase [deg]	Delay [ns]	File	Info...
0	On	-20.00	0.05	22	ists/waveforms/multi1	Info...
1	On	-50.00	50.00	0	_lists/waveforms/ARB	Info...
2	On	-50.00	70.00	0	_lists/waveforms/ARB	Info...
3	On	-50.00	90.00	0	_lists/waveforms/ARB	Info...

**No.** Indicates the carrier index ranging from 0 to (number of carriers -1).

Remote-control command:  
 - (individual carriers can be set using the commands SOUR:BB:ARB:MCAR:CARR:.. by specifying the index in the parameter.

**State** Switches a carrier on/off.

Remote-control command:  
 SOUR:BB:ARB:MCAR:CARR2:STAT ON

**Gain** Sets the gain of a carrier.

Remote-control command:  
 SOUR:BB:ARB:MCAR:CARR2:POW -30dB

<b>Phase</b>	<p>Sets the starting phase of a carrier.</p> <p>Remote-control command: SOUR:BB:ARB:MCAR:CARR2:PHAS 0DEG</p>
<b>Delay</b>	<p>Sets the starting delay of a carrier.</p> <p>Remote-control command : : SOUR:BB:ARB:MCAR:CARR2:DEL 2US</p>
<b>File</b>	<p>Calls the <b>File</b> menu for selecting the input file with the I/Q signal to be modulated onto the carrier.</p> <p>Remote-control command : : SOUR:BB:ARB:MCAR:CARR2:FILE "iq_test"</p>
<b>Info</b>	<p>Indicates the sample rate, number of I/Q value pairs (number of samples), and the resulting signal period of the selected I/Q input file.</p> <p>Remote-control command : n.a.</p>

**Carrier Graph - ARB Multi-Carrier**

Calls a graphical representation of the current multi-carrier configuration in the frequency domain.

The height of the bars corresponds to the chosen gain of each individual carrier. The bandwidth of the carriers signals is indicated by the width of the bars.

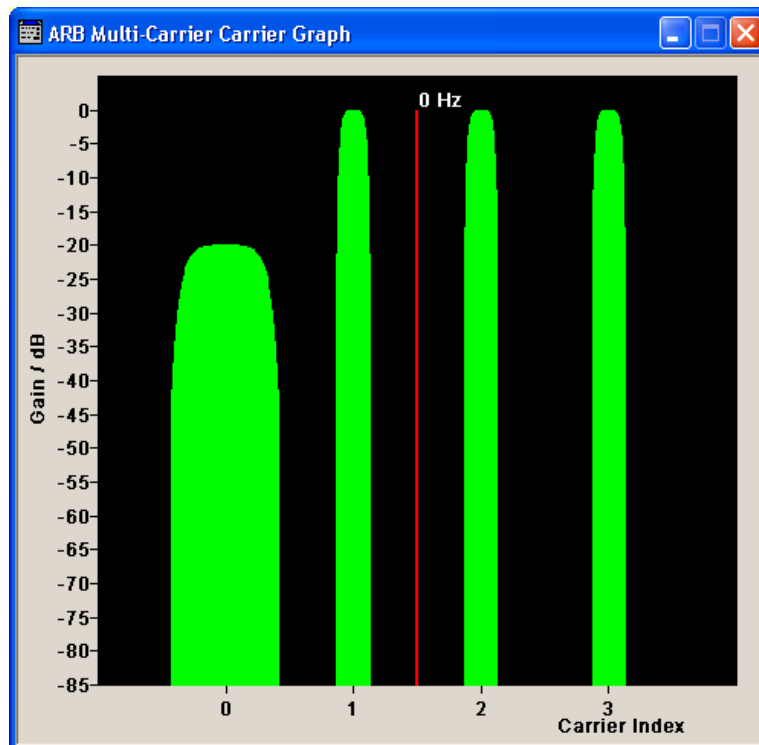

The **Output Settings** section in the multi-carrier main menu indicates the name, the size and the clock rate of the currently calculated multi-carrier output file.

**File - ARB Multi-Carrier** Opens the **File** menu, where the output file name of the multi-carrier waveform which has to be calculated can be entered.

The multi-carrier waveform is calculated and saved under this name by clicking the **Create** or **Create and Load** button.

Remote-control command:

```
SOUR:BB:ARB:WCAR:OFIL "Multi1"
```

**Clock Rate - ARB Multi-Carrier** Displays the resulting sample rate at which the multi-carrier waveform is output by the arbitrary waveform generator. The output clock rate depends on the number of carriers, carrier spacing and input sample rate of the leftmost or rightmost carriers.

Remote-control command:

```
SOUR:BB:ARB:MCAR:CLOC?
```

**File Size - ARB Multi-Carrier** Displays the resulting number of samples of the multi-carrier waveform.

Remote-control command:

```
SOUR:BB:ARB:MCAR:SAMP?
```

**Create - ARB Multi-Carrier** Creates a new multi-carrier waveform defined by the multi-carrier table and General Setting entries.

This multi-carrier waveform is saved with the file name specified in **Output File**. If no file name is specified, the File Manager opens so that the file name can be entered. As with normal waveforms, the file extension is **\*.wv**.

Depending on the configuration of the multi-carrier waveform, calculation may take some time. A panel with a progress bar and an **Abort** button appears during the calculation process.

Remote-control command:

```
SOUR:BB:ARB:WCAR:CRE
```

(in remote control the file name of the multi-carrier waveform file is determined with command `SOUR:BB:ARB:WCAR:OFIL 'wv_name'`)

**Create and Load - ARB  
Multi-Carrier**

Creates a new multi-carrier waveform defined by the multi-carrier table and General Setting entries and loads it subsequently in the **ARB** main menu.

This multi-carrier waveform is saved with the file name specified in **Output File**. If no file name is specified, the File Manager opens so that the file name can be entered. As with normal waveforms, the file extension is **\*.wv**.

Depending on the configuration of the multi-carrier waveform, calculation may take some time. A panel with a progress bar and an **Abort** button appears during the calculation process.

Remote-control command:

SOUR:BB:ARB:WCAR:CLO

(in remote control the file name of the waveform file is determined with command SOUR:BB:ARB:WCAR:OFIL 'wv\_name')

## Typical Applications for Multi-carrier Waveforms - ARB Menu

High Power Amplifiers of multi-carrier base stations face increased requirements in terms of linearity and acceptable intermodulation performance. A standard transmitter test might be quickly setup by the following instructions.

- Load a standardized 3GPP downlink test model, e.g. **Test Model 1\_16**; Set State to **ON**
- Create a 3GPP Testmodel ARB file by activating **Generate Waveform File**.
- Setup a multi-carrier scenario with 4 carriers and a carrier spacing of 5 MHz.
- Apply the input file containing the previously generated 3GPP testmodel to all 4 carriers.

## Multicarrier Continuous Wave

### Introduction - Multicarrier CW

The R&S Vector Signal Generator can generate a Multicarrier CW signal with user-definable offset from carrier, based on a selection of up to 8192 unmodulated carriers. Each carrier can be separately set and switched on, or multiple carriers can be jointly configured. Automatic start phase setting is provided in order to minimize the crest factor.

Multicarrier CW signals can be very easily configured as broadband test signals and used for such purposes as receiver tests.

The equipment layout for generating multicarrier signals includes the options baseband main module (B13), baseband generator (B9/B10/B11) and multicarrier CW (K61).



In the case of two-path instruments, at least one further option baseband generator (B9/B10/B11) is needed for multicarrier generation in the second path. Using this option a multicarrier signal can be defined in path B and then either routed via path A or added to the signal on path A with a frequency offset that can be set. Simultaneous generation of the multicarrier signal on path A and path B requires a second option Multicarrier CW (K61)). When path B is fully expanded with a second option baseband main module (B13) and an RF section frequency option (B20x) the multicarrier signal can be output on RF output B.

The menu for setting a Multicarrier CW signal can be opened either in the **Baseband** function block or in the menu tree for the **MENU** key under Baseband.

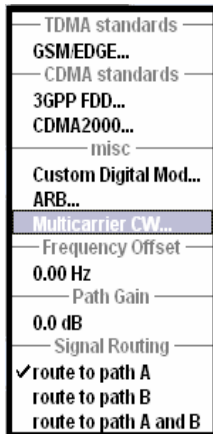

The **Multicarrier CW** menu is divided into the following sections.

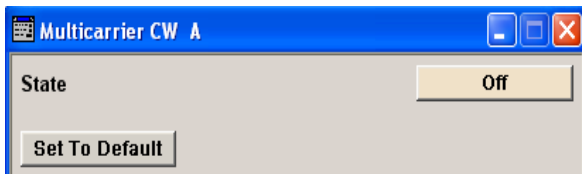

The upper part of the menu is used for powering up the Multicarrier CW and calling the default settings.

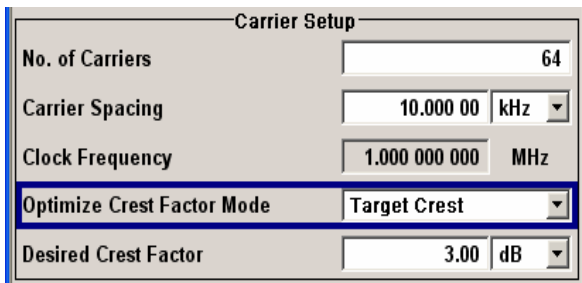

The **Carrier Setup** section is used to configure the Multicarrier CW signal.

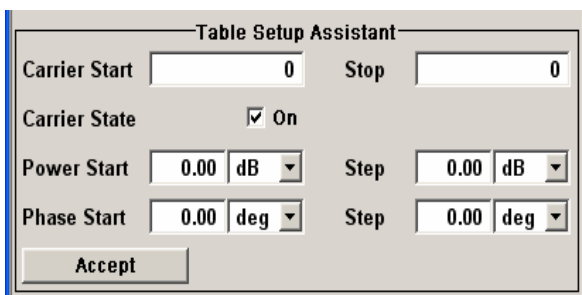

The **Table Setup Assistant** section can be used to set a selectable carrier range.



The buttons in the lower part of the menu open submenus for defining carrier tables and for configuring triggers, markers and clocks. The carrier settings can be checked in the graphical **Carrier Graph** submenu.

## Multicarrier CW Main Menu

The upper part of the menu is used for powering up the Multicarrier CW signal and calling the default settings.

**State - Multicarrier CW** Enables/disables the Multicarrier CW.

Switching on this standard turns off all the other digital standards and digital modulation modes on the same path.

Since Multicarrier CW signals are computed in arbitrary waveform mode, changes to the settings of individual carriers are not adopted until the **Accept** button is pressed. This applies to the settings in the **Table Setup Assistant** menu section and the **Carrier Table** submenu.

Remote-control command:  
 SOUR:BB:MCCW:STAT ON

**Set to Default - Multicarrier CW** Calls default settings. The values are shown in the following table.

Remote-control command:  
 SOUR:BB:MCCW:PRES

Parameter	Value
State	Not affected by <b>Set to Default</b>
<b>Carrier Setup</b>	
Number of Carriers	64
Carrier Spacing	10 kHz
Optimize Crest Factor	Chirp
Desired Crest Factor	3 dB
<b>Trigger</b>	
Mode	Auto
Source	Internal
Ext. Delay	0
Ext. Inhibit	0
<b>Marker</b>	
Channel 1...4	Restart
<b>Clock</b>	
Source	Internal
<b>Multi Channel Setup</b>	
Start Carrier	0
Stop Carrier	0

Parameter	Value
State	ON
Power	0 dB
Power Step	0 dB
Initial Phase	0°
Phase Step	0°
<b>Channel Setup</b>	
State	ON
Power	0 dB
Phase	0°

The **Carrier Setup** section is used to configure the Multicarrier CW.

#### Number of Carriers - Multicarrier CW

Sets the number of carriers for the Multicarrier CW signal.

By default the multicarrier table already lists 64 carriers that are preset to the settings State = ON, Power = 0 dB, Phase = 0°.

When entering fewer carriers than the table contains, the approach is generally to delete the superfluous entries from the table, and when entering more carriers than the table contains the missing entries are usually added at the end of the table.

Remote-control command:

SOUR:BB:MCCW:CARR:COUN 64

#### Carrier Spacing - Multicarrier CW

Sets the spacing between carriers for the Multicarrier CW signal.

The carriers are arranged symmetrically around the HF carrier.

The total bandwidth =  $(\text{Number of carriers} - 1) * \text{Carrier spacing}$ ; the result must not exceed 80 MHz.

Remote-control command:

SOUR:BB:MCCW:CARR:SPAC 10 kHz

#### Clock Frequency - Multicarrier CW

Displays the clock rate at which the multicarrier signal is output by the arbitrary waveform generator. The output clock rate depends on the number of carriers and the selected carrier offset.

The value indicates the resolution during the marker generation.

Remote-control command:

SOUR:BB:MCCW:CLOC?

**Optimize Crest Factor -  
Multicarrier CW**

Selects the mode for automatically minimizing the crest factor.

The carrier start phases are automatically set to this.

The crest factor represents the ratio of the peak voltage value to the rms voltage value. The higher the crest factor and resulting dynamics of a signal, the greater the requirement for a power amplifier fed by the signal to be linear.

A very high crest factor arises when the carriers have an identical start phase, since the carriers are periodically superposed and very high peak voltages occur in relation to the rms voltage values.

Methods of reducing the crest factor differ with regard to both the optimization achievable and the time required for computation.

The following modes are available:

**Off** There are no automatic settings for minimizing the crest factor. The **Phase** setting has an effect.

Remote-control command:

SOUR:BB:MCCW:CFAC:MODE OFF

**Chirp** Very rapid crest factor optimization regardless of the number of carriers. A minimal crest factor of < 3 dB is only obtained for multicarrier signals in which all carriers are switched on and the power of the carriers is identical. In a configuration which differs from this, the achievable crest factor is worse.

Remote-control command:

SOUR:BB:MCCW:CFAC:MODE CHIR

**Target Crest** Optimization of the crest factor to a desired value for all carrier configurations. The optimization time depends on the number of carriers and the desired crest factor. Computation time increases only when the number of carriers exceeds 256 and the crest factor is below 4 dB. The desired value can be entered in **Desired Crest Factor**.

---

**Note:**

*Optimization can be cancelled at any time, and the current value being displayed at that moment is then used.*

---

Remote-control command:

SOUR:BB:MCCW:CFAC:MODE SLOW

**Desired Crest Factor - Multicarrier CW** Enters the desired crest factor.

This is only possible when the optimization **Target Crest** has been selected.

Remote-control command:  
SOUR:BB:MCCW:CFAC 3 dB

The **Table Setup Assistant** section can be used to set a selectable carrier range. The carrier table can be edited in the **Carrier Table** submenu.

**Carrier Start - Multicarrier CW** Defines the start index of the carrier range to which the following settings are intended to apply.

Remote-control command:  
SOUR:BB:MCCW:EDIT:CARR:STAR 2

**Carrier Stop - Multicarrier CW** Defines the stop index of the carrier range to which the following settings are intended to apply.

Remote-control command:  
SOUR:BB:MCCW:EDIT:CARR:CARR:STOP 202

**Carrier State - Multicarrier CW** Switches the carriers in the carrier range on/off.

Remote-control command:  
SOUR:BB:MCCW:EDIT:CARR:STAT ON

**Power Start - Multicarrier CW** Sets the power of the starting carrier.

Remote-control command:  
SOUR:BB:MCCW:EDIT:CARR:POW 0 dB

**Power Step - Multicarrier CW** Sets the width of the step with which the power will be changed from carrier to carrier.

The carrier power that is set with  $Power + n * Power Step$  must be within the valid value range -80 dB to 0 dB.

Remote-control command:  
SOUR:BB:MCCW:EDIT:CARR:POW:STEP -0.2 dB

**Phase Start - Multicarrier CW** Sets the phase of the starting carrier. This setting is only available for Optimize Crest Factor Mode = Off.

Remote-control command:  
SOUR:BB:MCCW:EDIT:CARR:PHAS 0

**Phase Step - Multicarrier CW**

Sets the width of the step with which the phase will be changed from carrier to carrier.

The phase that is set with  $Phase + n * Phase Step$  must be within the valid value range 0° to 360°.

This setting is only available for Optimize Crest Factor Mode = Off.

Remote-control command:

```
SOUR:BB:MCCW:EDIT:CARR:PHAS:STEP 1DEG
```

**Accept - Multicarrier CW**

Adopts the carrier range setting into the table (Carrier Table).

Remote-control command:

```
SOUR:BB:MCCW:EDIT:CARR:EXEC
```

The lower part of the menu is used to open submenus for configuring carrier tables and for setting triggers, markers and clocks.

**Carrier Table - Multicarrier CW**

Calls the table for configuring individual carriers. This configuration can be checked with the aid of the **Carrier Graph**.

	State	Power / dB	Phase / deg
0	On	0.00	0.00
1	On	0.00	0.00
2	On	0.00	0.00
3	Off	0.00	0.00
4	Off	0.00	0.00
5	Off	0.00	0.00
6	On	0.00	0.00
7	On	0.00	0.00
8	On	0.00	0.00

The table displays the settings of all available carriers. Carriers in the On state are highlighted. All carrier parameters can be edited in the table.

The Multicarrier CW signal is only computed when the **Accept** button is pressed. Whenever the table contains settings that have not yet been adopted with the **Accept** button, the background is yellow.

**Note:**

*The phase/deg settings are only valid if optimization of the crest factor is disabled (Optimize Crest Factor = Off).*

<b>No.</b>	<p>This is the carrier index.</p> <p>Remote-control command:          - (individual carriers can be set using the commands <code>SOUR:BB:MCCW:CARR:..</code> by specifying the index in the parameter.          All the carriers in a multicarrier configuration can also be set using a value list with the commands <code>SOUR:BB:MCCW:CARR:LIST...</code>)</p>
<b>State</b>	<p>Switch a carrier on/off</p> <p>Remote-control command:  <code>SOUR:BB:MCCW:CARR:LIST:STAT ON,OFF,..</code>  <code>SOUR:BB:MCCW:CARR:STAT 2,ON</code></p>
<b>Power</b>	<p>Sets the power of a carrier.</p> <p>Remote-control command:  <code>SOUR:BB:MCCW:CARR:LIST:POW -3,-3,..</code>  <code>SOUR:BB:MCCW:CARR:POW 2,-30dB</code></p>
<b>Phase</b>	<p>Sets the starting phase of a carrier.</p> <p>Remote-control command:  <code>SOUR:BB:MCCW:CARR:LIST:PHAS 0,0,..</code>  <code>SOUR:BB:MCCW:CARR:PHAS 2, 0DEG</code></p>
<b>Accept</b>	<p>Transfer the settings in the carrier table into the instrument.</p> <p>Remote-control command: n.a.          (the values specified when the command is given are adopted immediately)</p>
<b>Carrier Graph - Multicarrier CW</b>	<p>Calls a graphical representation of the chosen carrier configuration.</p> <p>The carriers are on the X-axis and the colored bars represent those carriers which are in the On state. Power is on the Y-axis, and the height of the bars corresponds to the chosen power of each individual carrier.</p>

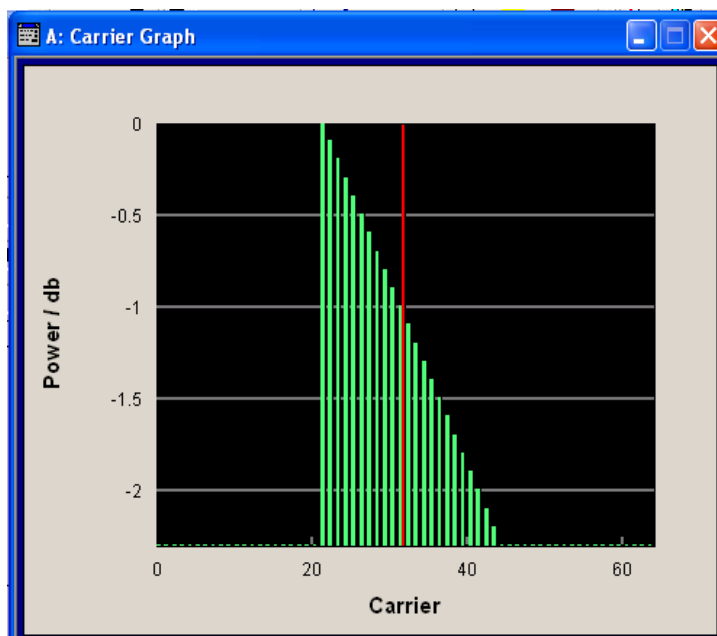
**Trigger-Marker -  
Multicarrier CW**

Calls the **Trigger/Marker** menu. This menu is used to select the trigger source, set the time delay on an external trigger signal and configure the marker output signals (see section "[Trigger/Marker/Clock Menu - Multicarrier CW](#)", page 4.253).

Remote-control command: n.a.

**Clock - Multicarrier CW**

Calls the Clock menu. The Clock menu is used to select the clock source (see section "[Trigger/Marker/Clock Menu - Multicarrier CW](#)", page 4.253).

Remote-control command: n.a.



# Trigger/Marker/Clock Menu - Multicarrier CW

The Trigger menu is accessed via the **Multicarrier CW** main menu.

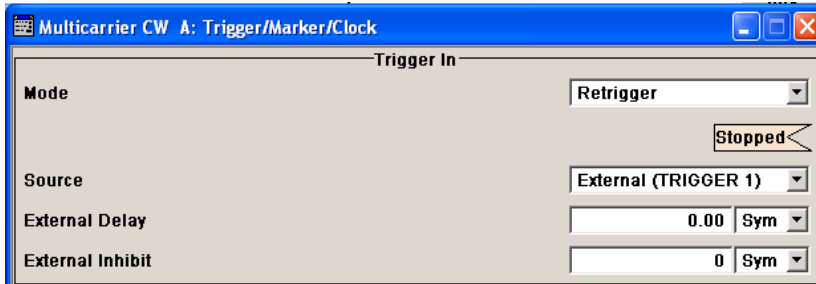

The **Trigger In** section is where the trigger for the waveform is set. Various parameters will be provided for the settings, depending on which trigger source - internal or external - is selected. The current status of signal generation (**Running** or **Stopped**) is indicated for all trigger modes.

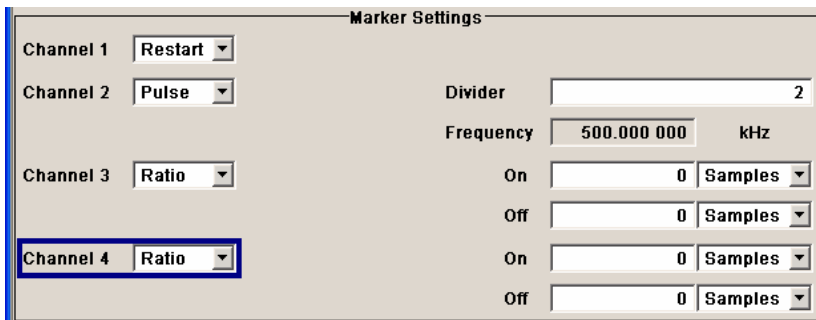

The **Marker Settings** section is where the marker signals at the MARKER output connectors are configured.

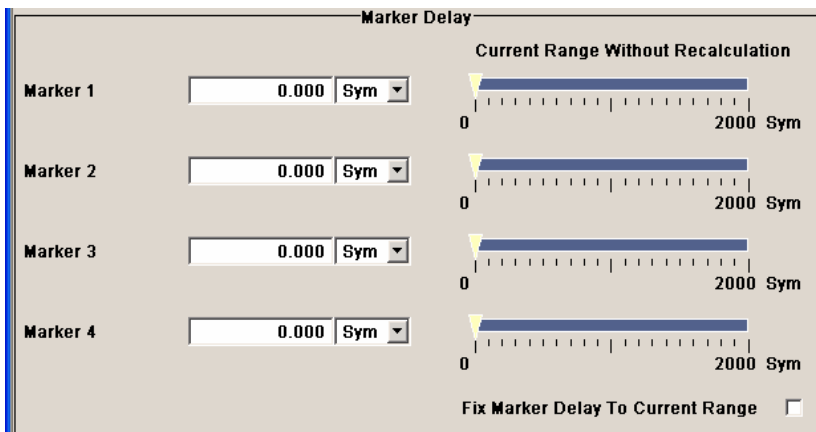

The **Marker Delay** section is where a marker signal delay can be defined, either without restriction or restricted to the dynamic section, i.e., the section in which it is possible to make settings without restarting signal and marker generation.

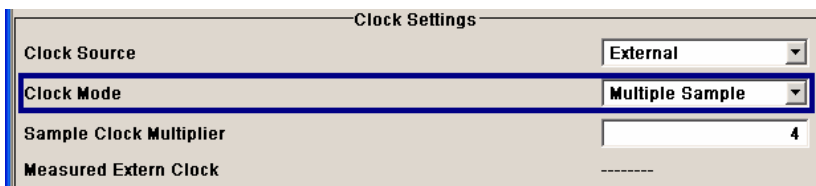

The **Clock Settings** section is where the clock source is selected and - in the case of an external source - the clock type.



The **Global Trigger/Clock Settings** button leads to a submenu for general trigger, clock and external input settings

The **Trigger In** section is used to configure the trigger signal for the Multicarrier CW modulation. The current status of signal generation is indicated for all trigger modes.

**Trigger Mode - Multicarrier CW** Selects trigger mode.

<b>Auto</b>	The multicarrier signal is generated continuously. Remote-control command: SOUR:BB:MCCW:SEQ AUTO
<b>Retrigger</b>	The multicarrier signal is generated continuously. A trigger event (internal or external) causes a restart. Remote-control command: SOUR:BB:MCCW:SEQ RETR
<b>Armed_Auto</b>	The multicarrier signal is generated only when a trigger event occurs. Then the multicarrier signal is generated continuously. Button <b>Arm</b> stops signal generation. A subsequent trigger event (internal with <b>Execute Trigger</b> or external) causes a restart. Remote-control command: SOUR:BB:MCCW:SEQ AAUT
<b>Armed_Retrigger</b>	The multicarrier signal is generated only when a trigger event occurs. Then the signal is generated continuously. Every subsequent trigger event causes a restart. Button <b>Arm</b> stops signal generation. A subsequent trigger event (internal with <b>Execute Trigger</b> or external) causes a restart. Remote-control command: SOUR:BB:MCCW:SEQ ARET
<b>Single</b>	The multicarrier signal is generated only when a trigger event occurs. Then the signal is output once in the length specified in <b>Signal Duration</b> . Every subsequent trigger event (internal with <b>Execute Trigger</b> or external) causes a restart. Remote-control command: SOUR:BB:MCCW:SEQ SING

**Trigger Signal Duration - Multicarrier CW**

Enters the length of the signal sequence to be output in the **Single** trigger mode. The input is to be expressed in sequence length (SL). It is then possible to output deliberately just part of the waveform, an exact sequence of the waveform, or a defined number of repetitions of the waveform.

Remote-control commands:  
SOUR:BB:MCCW:TRIG:SLEN 2

**Running - Stopped -  
Multicarrier CW**

Displays the status of multicarrier signal generation for all trigger modes. This display appears only when Multicarrier CW is enabled (**State On**).

Remote-control command:  
 SOUR:BB:MCCW:TRIG:RMOD?  
 Response: RUN or STOP

- Running**            The multicarrier signal is generated; a trigger was (internally or externally) initiated in triggered mode. If **Armed\_Auto** and **Armed\_Retrigger** have been selected, generation of signals can be stopped with the **Arm** button. A new trigger (internally with **Execute Trigger** or externally) causes a restart.
- Stopped**            The signal is not generated, and the instrument waits for a trigger event (internal or external).

**Arm - Multicarrier CW**

Stops multicarrier signal generation. This button appears only with **Running** signal generation in the **Armed\_Auto** and **Armed\_Retrigger** trigger modes.

Signal generation can be restarted by a new trigger (internally with **Execute Trigger** or externally).

Remote-control command:  
 SOUR:BB:MCCW:TRIG:ARM:EXEC

**Execute Trigger -  
Multicarrier CW**

Executes trigger manually. A manual trigger can be executed only when an internal trigger source and a trigger mode other than **Auto** have been selected.

Remote-control command:  
 SOUR:BB:MCCW:TRIG:SOUR INT  
 SOUR:BB:MCCW:SEQ RETR  
 SOUR:BB:MCCW:TRIG:EXEC

**Trigger Source -  
Multicarrier CW**

Selects trigger source

**Internal**            The trigger event is executed by **Execute Trigger**. As a precondition a trigger mode other than **Auto** must be selected.

Remote-control command:  
 SOUR:BB:MCCW:TRIG:SOUR INT

**Internal (Baseband A/B)**    The trigger event is executed by the trigger signal from the second path (two-path instruments only).

Remote-control command:  
 SOUR:BB:MCCW:TRIG:SOUR OBAS

**External  
(TRIGGER 1|2)**

The trigger event is executed with the aid of the active edge of an external trigger signal. The trigger signal is supplied via the TRIGGER 1 or TRIGGER 2 connector.

The polarity, the trigger threshold and the input impedance of the TRIGGER input can be set in the **Global Trigger Settings** menu.

Remote-control command:

```
SOUR:BB:MCCW:TRIG:SOUR EXT | BEXT
```

**Trigger Delay - Multicarrier  
CW**

Sets trigger signal delay in samples on external triggering or on internal triggering via the second path.

This enables the R&S Vector Signal Generator to be synchronized with the device under test or other external devices.

**Note**

*The delay can be set separately for each of the two paths.*

Remote-control command:

```
SOUR:BB:MCCW:TRIG:EXT:DEL 0
SOUR:BB:MCCW:TRIG:OBAS:DEL 0
```

**Trigger Inhibit - Multicarrier  
CW**

Sets the duration for inhibiting a new trigger event subsequent to triggering. The input is to be expressed in samples.

In the **Retrigger** mode every trigger signal causes signal generation to restart. This restart is inhibited for the specified number of samples:

This parameter is only available on external triggering or on internal triggering via the second path.

**Note:**

*The trigger inhibit can be set separately for each of the two paths.*

Remote-control command:

```
SOUR:BB:MCCW:TRIG:EXT:INH 0
SOUR:BB:MCCW:TRIG:OBAS:INH 0
```

The settings for the marker output signals are entered in the **Marker Mode** section.

**Marker Channel x - Multicarrier CW**

Selects a marker signal for the associated MARKER output.

**Restart**

A brief marker signal is generated at the start of the waveform.

Remote-control command:

```
SOUR:BB:MCCW:TRIG:OUTP1:MODE REST
```

**Pulse**

A regular marker signal is generated. The pulse frequency is defined by entering a divider. The frequency is derived by dividing the sample rate by the divider. The input box for the divider opens when **Pulse** is selected, and the resulting pulse frequency is displayed below it.

Divider	8.00
Frequency	33.854 17 kHz

Remote-control command: :

```
SOUR:BB:MCCW:TRIG:OUTP1:MODE PULS
SOUR:BB:MCCW:TRIG:OUTP1:PULS:DIV 4
SOUR:BB:MCCW:TRIG:OUTP1:PULS:FREQ?
```

**Pattern**

A marker signal that is defined by a bit pattern is generated. The pattern has a maximum length of 32 bits and is defined in an input field which opens when **Pattern** is selected.

0000 0000
-----------

Remote-control command:

```
SOUR:BB:MCCW:TRIG:OUTP1:MODE PATT
SOUR:BB:MCCW:TRIG:OUTP1:PATT #H00,8
```

**ON/OFF ratio**

A regular marker signal that is defined by an ON/OFF ratio is generated. A period lasts one ON and OFF cycle.

Start of signal

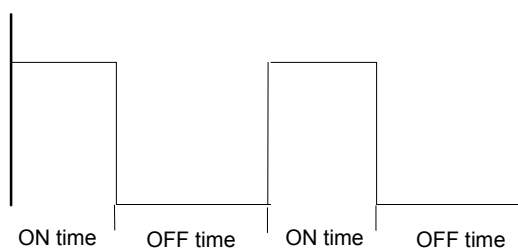

The ON time and OFF time are each expressed as a number of samples and are set in an input field which opens when **ON/OFF ratio** is selected.

On Time	<input type="text" value="1"/>	Samples ▾
Off Time	<input type="text" value="1"/>	Samples ▾

Remote-control command:

```
SOUR:BB:MCCW:TRIG:OUTP1:MODE RAT
```

```
SOUR:BB:MCCW:TRIG:OUTP1:OFFT 20
```

```
SOUR:BB:MCCW:TRIG:OUTP1:ONT 20
```

The delays for the marker output signals are entered in the **Marker Delay** section.

**Marker x Delay - Multicarrier CW**

Enters the delay between the marker signal at the marker outputs and the start of the signal.

The input is expressed as a number of samples. If the setting "**Fix marker delay to dynamic range**" is enabled, the setting range is restricted to the dynamic range. In this range the delay of the marker signals can be set without restarting the marker and signal.

Remote-control command:

```
SOUR:BB:MCCW:TRIG:OUTP2:DEL 2
```

**Current Range without Recalculation - Multicarrier CW**

Displays the dynamic range within which the delay of the marker signals can be set without restarting the marker and signal.

The delay can be defined by moving the setting mark.

Remote-control command:

```
SOUR:BB:MCCW:TRIG:OUTP2:DEL:MAX?
```

```
SOUR:BB:MCCW:TRIG:OUTP2:DEL:MIN?
```

**Fix marker delay to current range - Multicarrier CW**

Restricts the marker delay setting range to the dynamic range. In this range the delay can be set without restarting the marker and signal.

Remote-control command:

```
SOUR:BB:MCCW:TRIG:OUTP:DEL:FIX ON
```

The **Clock Settings** section can be used to select the clock source.

**Clock Source - Multicarrier CW** Selects the clock source (also see section Clock Signals, page 4.154)

**Internal** The internal clock reference is used to generate the sample clock.

Remote-control command:  
SOUR:BB:MCCW:CLOC:SOUR INT

**External** The external clock reference is fed in as the sample clock or multiple thereof via the CLOCK connector.

The polarity of the clock input can be changed with the aid of **Global Trigger/Clock Settings**.

In the case of two-path instruments this selection applies to path A.

Remote-control command:  
SOUR:BB:MCCW:CLOC:SOUR EXT

**Clock Mode - Multicarrier CW** Enters the type of externally supplied clock.

**Sample** A sample clock is supplied via the CLOCK connector.

Remote-control command:  
SOUR:BB:MCCW:CLOC:MODE SAMP

**Multiple** A multiple of the sample clock is supplied via the CLOCK connector; the sample clock is derived internally from this.

The **Multiplier** window provided allows the multiplication factor to be entered.

Remote-control command:  
SOUR:BB:MCCW:CLOC:MODE MSAM

**Sample Clock Multiplier - Multicarrier CW** Enters the multiplication factor for clock type **Multiple**.

Remote-control command:  
SOUR:BB:MCCW:CLOC:MULT 4

**Measured External Clock - Multicarrier CW** Indicates of the measured frequency of the external clock signal. This enables the user to permanently monitor the frequency of the externally introduced clock.

This information is displayed only if the external clock source has been selected.

Remote-control command: :CLOC:INP:FREQ?

**Global Trigger-Clock-Input Settings - Multicarrier CW** Calls the **Global Trigger/Clock/Input Settings** menu. This menu is used among other things for setting the trigger threshold, the input impedance and the polarity of the clock and trigger inputs.

In the case of two-path instruments these settings are valid for both paths.

The parameters in this menu affect all digital modulations and standards, and are described in the section "[Global Trigger/Clock/Input Settings – Setup -Environment](#)".

## Digital Standard GSM/EDGE

### Introduction - Digital Standard GSM/EDGE

The R&S Vector Signal Generator enables you to generate signals in accordance with the GSM/EDGE standard.

The equipment layout for generating GSM/EDGE signals includes the options Baseband Main Module (B13), Baseband Generator (B10/B11) and Digital Standard GSM/EDGE (K40)).

In the case of two-path instruments, at least one further option R&S SMU-B10/B11 (Baseband Generator) is needed for generating a GSM/EDGE signal in the second path. Using this option a GSM/EDGE signal can be defined in path B and then either routed via path A or added to the signal on path A with a frequency offset that can be set. Simultaneous generation of the GSM/EDGE signal on path A and path B requires a second option R&S SMU-K40 (Digital Standard GSM/EDGE). When path B is fully expanded with a second option R&S SMU-B13 (Baseband Main Module) and an RF section (Frequency Option R&S SMU-B20x) the GSM/EDGE signal can be output on RF output B.

GSM is a TDMA standard for cellular mobile radio networks and is used worldwide. The R&S Vector Signal Generator is suitable as a signal generator for all GSM variants. There is no restriction regarding the use of GSM slots and EDGE slots.

The R&S Vector Signal Generator can generate both the transmitter signal of a base station (BS) and the transmitter signal of a user equipment (UE).

Every TDMA frame consists of 8 timeslots (or simply "slots"). Each slot can be separately turned on or off. A maximum of 7 different level attenuation values can be defined and allocated separately to the 8 slots quite independently of one another.



In order to configure a slot it is necessary to define a burst type. You can choose between data bursts Normal (full rate and half rate) and EDGE; control bursts Access, Frequency Correction and Synchronization; a Dummy Burst; and bursts for test purposes, All\_Data (GSM and EDGE). Not only can you generate half rate slots but you can also define multislots for HSCSD (high speed circuit switched data) and (E)GPRS (general packet radio service) configurations at the physical level, if necessary allocating multiple slots to a single connection (channel banding).

The modulation data is continuously inserted into the chosen slots (in realtime). In this fashion the data generator uses a digital signal processor to generate a data stream complete with modulation data and control signals for power ramping.

This data stream is converted into I/Q signals in the modulation encoder. In accordance with the GSM standard, the MSK modulation type is set by default to a symbol rate of 270.833 ksymb/s and Gauss filtering. The symbol rate can be changed in the R&S Vector Signal Generator. FSK with adjustable span can also be used as the modulation type.

In accordance with the standard, in the case of EDGE slots the 8PSK modulation type is set by default to  $3/8\pi$  rotation at a symbol rate of 270.833 ksymb/s and Gauss linearized filtering.

Three modes are available for configuring a GSM/EDGE signal:

- **Mode Unframed** - a signal with standard-compliant modulation parameters but without slot and frame structure is generated.
- **Mode Frame (Single)** - a signal consisting of a frame is generated; it is also possible to choose half rate bursts and to define multislots.
- **Mode Frame (Double)** - a signal consisting of two frames is generated; the frames are repeated according to a defined default.

## GSM/EDGE menu

The menu for setting the digital standard can be opened either in the **Baseband** block or in the menu tree under Baseband.

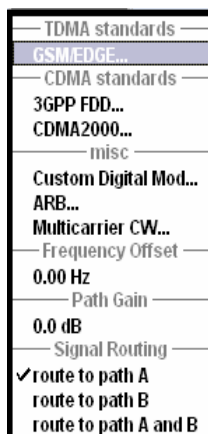

## Digital Standard GSM/EDGE Main Menu

The menu offered differs according to the mode selected. Most of the submenus and settings are available to all modes, however.

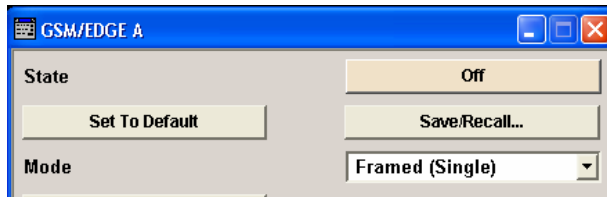

The upper part of the menu is used for turning on the GSM/EDGE digital standard and choosing the mode.

The **Set to Default** button calls the default settings for the GSM/EDGE standard.

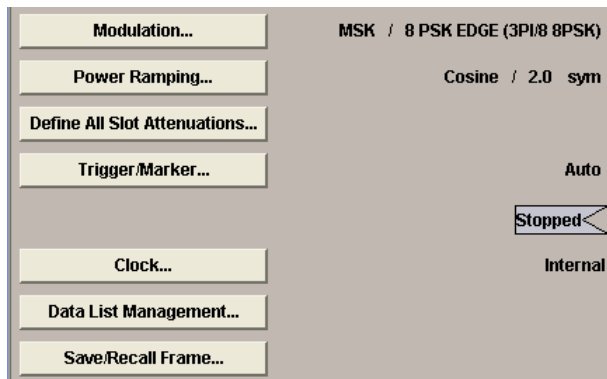

The submenus for choosing the modulation, for setting the trigger and clock parameters, and for data list management are available to all modes.

For all modes except Unframed, the submenu for saving and loading a frame and for setting the power ramping and slot attenuation are also available.

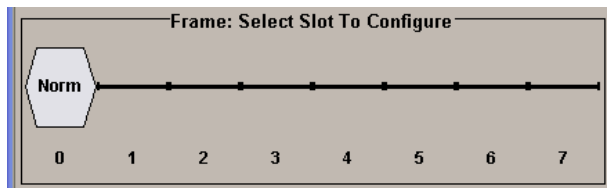

The lower part of the menu displays the chosen frame configuration, except in Unframed mode when it displays the signal configuration.

In this graphical display you can select the slot that you wish to edit. The burst editor then opens.

The upper part of the menu is used for turning on and resetting the GSM/EDGE digital standard and for choosing the mode.

### State - GSM/EDGE

Switches the GSM/EDGE standard on/off.

Switching on this standard turns off all the other digital standards and digital modulation types on the same path.

GSM/EDGE is a realtime system (no precalculated signal), and therefore all parameter changes (in the ON state) directly affect the output signal.

Remote-control command:  
SOUR:BB:GSM:STAT ON

### Set to Default - GSM/EDGE

Calls default settings. The values are shown in the following table.

Remote-control command:  
SOUR:BB:GSM:PRES

Parameter	Value
State	Not affected by Set to Default
Mode	Framed (single)
Modulation	
Symbol Rate	270.833 ksymb/s
Ignore ¼...	Off
Mod. Type GSM	GMSK
Deviation	67.708 kHz
Filter	Gauss
Filter Par. BT	0.3
Mod. Type Edge	8 PSK EDGE
Filter	Gauss linear
Trigger	
Mode	Auto
Source	Internal
Ext. Delay	0 symbols
Ext. Inhibit	0 symbols
Marker Mode	Frame
Marker Period	0 frames
Marker Delay	0 symbols
Clock	
Source	Internal
Mode	Symbol
Delay	0 symbols
Power Ramp Control	
Time	3 sym
Function	Cosine
Delay	0 symbols
Rise Offset	0 symbols
Fall Offset	0 symbols
Slot Attenuation 1...7	0 dB
Slot 0 Configuration	
Burst Type	Normal (full rate)
Slot Level	Full
Multislot	Off
Number of Slots	1
Data	PRBS 9
Use Stealing Flag	On
Stealing Flag	0
TSC	TSC 0
Slot 1-7 Configuration	
Slot Level, other settings as slot 0	Off

**Mode - GSM/EDGE** Selects GSM/EDGE mode.

There are three modes available:

- Unframed (see [Mode Unframed - GSM/EDGE, page 4.268](#))
- Framed (single) (see [Mode Framed \(single\) - GSM/EDGE, page 4.270](#))
- Framed (double) (see [Mode Framed \(double\) - GSM/EDGE, page 4.272](#))

Remote-control command:

SOUR:BB:GSM:MODE UNFR | SING | DOUB

The middle part of the menu is identical for all modes except Unframed, for which some of the submenus are not available.

**Save/Recall - GSM/EDGE** Calls the **Save/Recall** menu.

From the **Save/Recall** menu, the **File Select** windows for saving and recalling GSM configurations and the **File Manager** can be called.



Remote-control command: n.a.

**Recall GSM setting**

Opens the **File Select** window for loading a saved GSM configuration.

The configuration of the selected (highlighted) file is loaded by pressing the **Select** button.

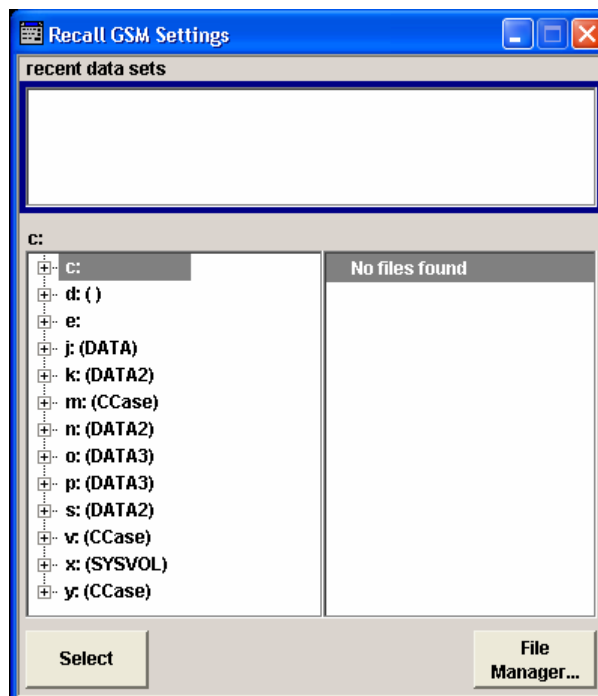

Remote-control command:

```
MMEM:CDIR 'F:\gen_lists\gsm'
```

```
SOUR:BB:GSM:SETT:CAT?
```

```
Response: 'gsm_1', gsm_2'
```

```
SOUR:BB:GSM:SETT:LOAD "gsm_1"
```

**Save GSM setting**

Opens the **File Select** window for saving the current GSM signal configuration.

The name of the file is specified in the **File name** entry field, the directory selected in the **save into** field. The file is saved by pressing the **Save** button.

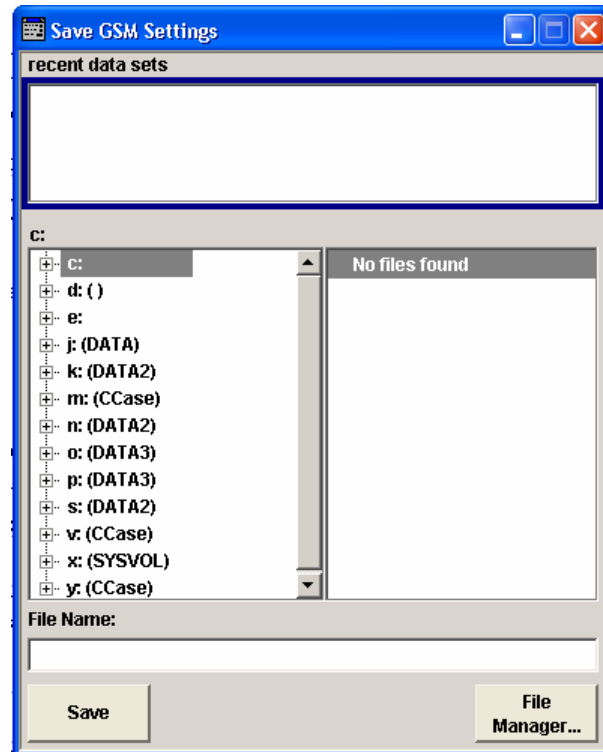

Remote-control command:

```
M MEM:CDIR 'F:\gen_lists\gsm'
```

```
SOUR:BB:GSM:SETT:STOR 'gsm_1'
```

**File Manager**

Calls the **File Manager**.

The **File Manager** is used to copy, delete and rename files and to create new directories.

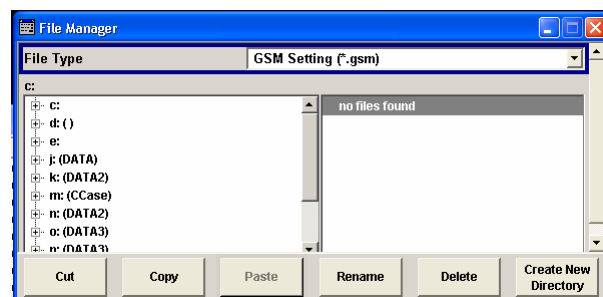

Remote-control commands:

```
M MEM:CDIR 'F:\gen_lists\gsm'
```

```
SOUR:BB:GSM:SETT:DEL 'gsm_1'
```

<b>Modulation - GSM/EDGE</b>	<p>Calls the Modulation menu. The Modulation menu is used for setting the modulation and filter parameters (see section "<a href="#">Modulation - GSM/EDGE</a>", page 4.277).</p> <p>Remote-control command: n.a.</p>
<b>Power Ramping - GSM/EDGE</b>	<p>Calls the Power Ramping menu. The Power Ramping menu is used to set the power ramping parameters (see section "<a href="#">Power Ramping - GSM/EDGE</a>", page 4.279).</p> <p>The currently selected ramp function and ramp time are displayed.</p> <p>Remote-control command: n.a.</p>
<b>All Slot Attenuations - GSM/EDGE</b>	<p>Calls the menu for setting values for the level attenuation in dB (see section "<a href="#">Power Ramping - GSM/EDGE</a>", page 4.279).</p> <p>Remote-control command: n.a.</p>
<b>Trigger/Marker - GSM/EDGE</b>	<p>Calls the <b>Trigger/Marker/Clock</b> menu.</p> <p>This menu is used to select the trigger source, configure the marker output signals and set the time delay on an external trigger signal (see section "Trigger/Marker/Clock - GSM/EDGE", page 4.282)</p> <p>Remote-control command: n.a.</p>
<b>Execute Trigger - GSM/EDGE</b>	<p>Executes trigger manually. A manual trigger can be executed only when an internal trigger source and a trigger mode other than Auto have been selected.</p> <p>Remote-control commands: SOUR:BB:GSM:TRIG INT SOUR:BB:GSM:SEQ RETR SOUR:BB:GSM:TRIG:EXEC</p>
<b>Clock - GSM/EDGE</b>	<p>Calls the <b>Trigger/Marker/Clock</b> menu. This menu is used to select the clock source (see section "Trigger/Marker/Clock - GSM/EDGE", page 4.282).</p> <p>Remote-control command: n.a.</p>

**Data List Management - GSM/EDGE**

Calls the **Data List Management** menu. This menu is used to select and edit a data list.

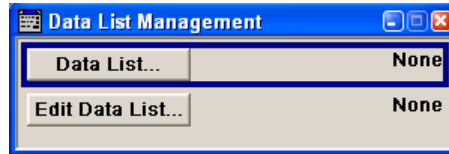

All data lists are stored as files with the predefined file extension **\*.dm\_iqd**. The file name and the directory they are stored in are user-definable.

The data lists must be selected as a data source in the Burst Editor.

The operation of the File Select menu for selecting a data list (**Data List...** button) and the Data List editor for editing a data list (**Edit Data List...** button) is described in detail in Chapter 3, Manual Operation.

Remote-control commands:

**Note:**

*All data lists are generated and edited by means of the SOURce:BB:DM subsystem commands. Files containing data lists end with \*.dm\_iqd. The data lists are selected as a data source for a specific function in the individual subsystems of the digital standard.*

Creating and editing the data list:

```
SOUR:BB:DM:DLIS:SEL "gsm"
SOUR:BB:DM:DLIS:DATA 1,1,0,1,0,1,0,1,0,1,1,1,1,0,0,0
SOUR:BB:DM:DLIS:DATA:APP
1,1,0,1,0,1,0,1,1,1,1,0,0,0
```

Selecting the data list:

```
SOUR:BB:GSM:FRAM:SLOT2:USER:SOUR:DATA DLIS
SOUR:BB:GSM:FRAM:SLOT2:USER:SOUR:DSEL "gsm"
```

**Mode Unframed - GSM/EDGE**

In **Unframed** mode a modulation signal without slot or frame structure is generated. The modulated carrier without power ramping is often enough for initial tests, and the complete signal is not yet needed.

Since all the modulation parameters for the signal already conform to the standard, the right modulation (in this case MSK for GSM and 8PSK EDGE for EDGE), symbol rate and filter configuration are set.

This mode can be used for quick measurements of the spectrum or signal quality (e.g. EVM).

The submenus for selecting the modulation (see section "[Modulation - GSM/EDGE](#)", page 4.277), as well as the trigger, marker and clock (see section "[Trigger/Marker/Clock - GSM/EDGE](#)", page 4.282) are offered.



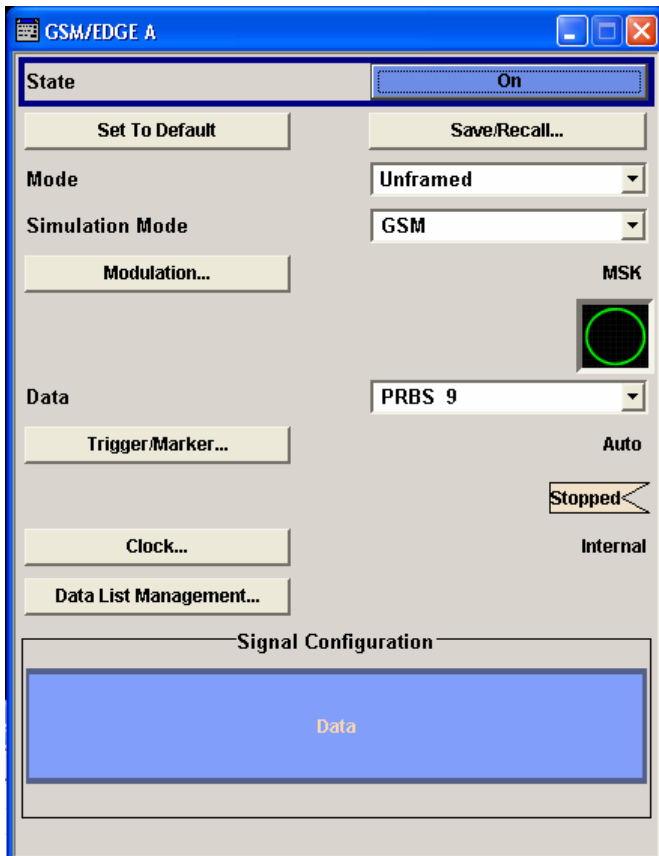

**Simulation Mode - GSM/EDGE**

Chooses between the GSM and EDGE standards for the signal. The signal is generated without slot or frame structure. For GSM the modulation that is set under **Modulation** is used. The modulation used for EDGE is always 8PSK. The chosen modulation is also displayed in graphical form:



GSM with MSK or FSK



EDGE with 8PSK

Remote-control command:

SOUR:BB:GSM:SMOD GSM | EDGE

The graphical display shows the signal in **Unframed** mode - no frames, no power ramping.

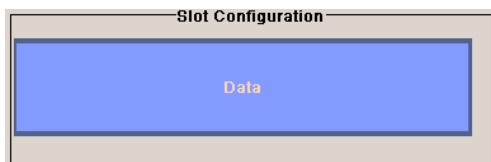

**Data - GSM/EDGE**

Selects data source.

You may choose from the following data sources:

**All 0**  
**All 1**

0 data or 1 data is internally generated.

Remote-control command:

```
SOUR:BB:GSM:SLOT0:DATA ALL0 | ALL1
```

**Pattern**  
**Pattern**

A user-definable bit pattern with a maximum length of 64 bits is internally generated.

The bit pattern is defined in the **Pattern** input box.



Remote-control command:

```
SOUR:BB:GSM:SLOT0:DATA PATT
```

```
SOUR:BB:GSM:SLOT0:DATA:PATT #H18F0,16
```

**PRBS xx**

PRBS data in accordance with the IUT-T with period lengths between  $2^9-1$  and  $2^{23}-1$  are internally generated.

Remote-control command:

```
SOUR:BB:GSM:SLOT0:DATA PN9 | PN11 |
```

...

**Data List**  
**Select List**

Internal data from a programmable data list created with the aid of the data editor is used.

Data lists are selected from the **Select List** submenu.



Remote-control command:

```
SOUR:BB:GSM:SLOT0:DATA DLIS
```

```
SOUR:BB:GSM:SLOT0:DATA:DLIS "gsm_1"
```

## Mode Framed (single) - GSM/EDGE

The **Framed (single)** mode generates a modulation signal which is defined by the structure of a single frame. The frame structure is repeated cyclically, but the useful data is continuously generated.

The frame structure is displayed in graphical form. Slot parameters can be defined in the burst editor, which is called when the slot is selected in the graphical display (see section "[Burst Editor - GSM/EDGE](#)", page 4.292). You can define half rate slots. The characteristics of each half rate slot can be defined separately. Each active slot is represented by a burst symbol. Two half rate slots occupy the space of a full rate slot. A slot in which the level has been attenuated is represented by a lower amplitude burst. Inactive slots (Slot Level = Off) are shown as a horizontal bar. If multislots have been defined, the banded slots are surrounded by a frame (slots 5 to 7 in the illustration).

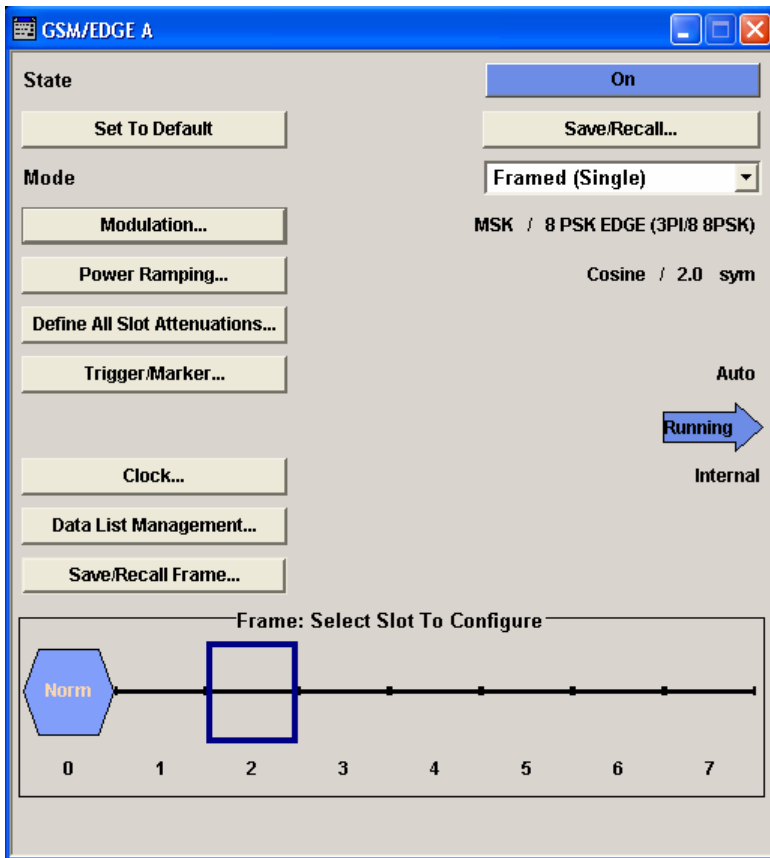

When a half rate slot has been selected, two frames are generated alternately. Each frame holds one of the two half rate users:

**Example:**

The following configuration is set, from a frame with two slots that contain half rate users:

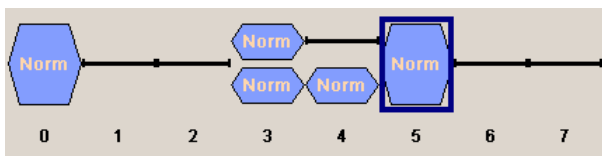

As a result the following two frames are generated alternately:

Frame with half rate user 1

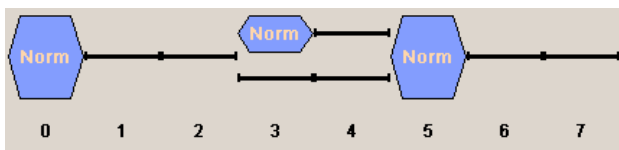

Frame with half rate user 2

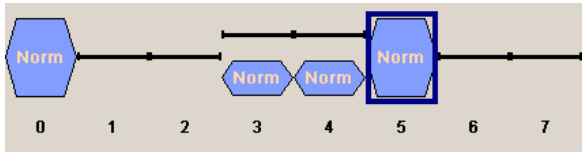

The following submenus are offered:

- For saving and loading a frame structure (see section "[Save Recall Frame/Slots - GSM/EDGE](#)", page 4.274).
- For selecting the modulation (see section "[Modulation - GSM/EDGE](#)", page 4.277).
- For selecting the trigger, marker and clock (see section "[Trigger/Marker/Clock - GSM/EDGE](#)", page 4.282).
- For power ramping (see section "[Power Ramping - GSM/EDGE](#)", page 4.279).
- For defining the attenuation (see section "[Power Ramping - GSM/EDGE](#)", page 4.279).

## Mode Framed (double) - GSM/EDGE

The **Framed (double)** mode generates multiframe signals which are defined by the structure of two frames.

For this purpose two frames are defined as in **Framed (single)** mode. A repetition factor is then specified for each of the two frames. Following a trigger the first frame is repeated the specified number of times, and then the second frame. The frame structures are repeated cyclically, but the useful data is continuously generated.

If one of the frames contains half rate slots (and so actually consists of 2 frames itself), the repetition factor must be a multiple of 2 (see previous section "[Mode Framed \(single\) - GSM/EDGE](#)".)

The frame structure of the two frames is displayed in graphical form. Slot parameters can be defined in the burst editor, which is called when the slot is selected in the graphical display (see section "[Burst Editor - GSM/EDGE](#)", page 4.292).

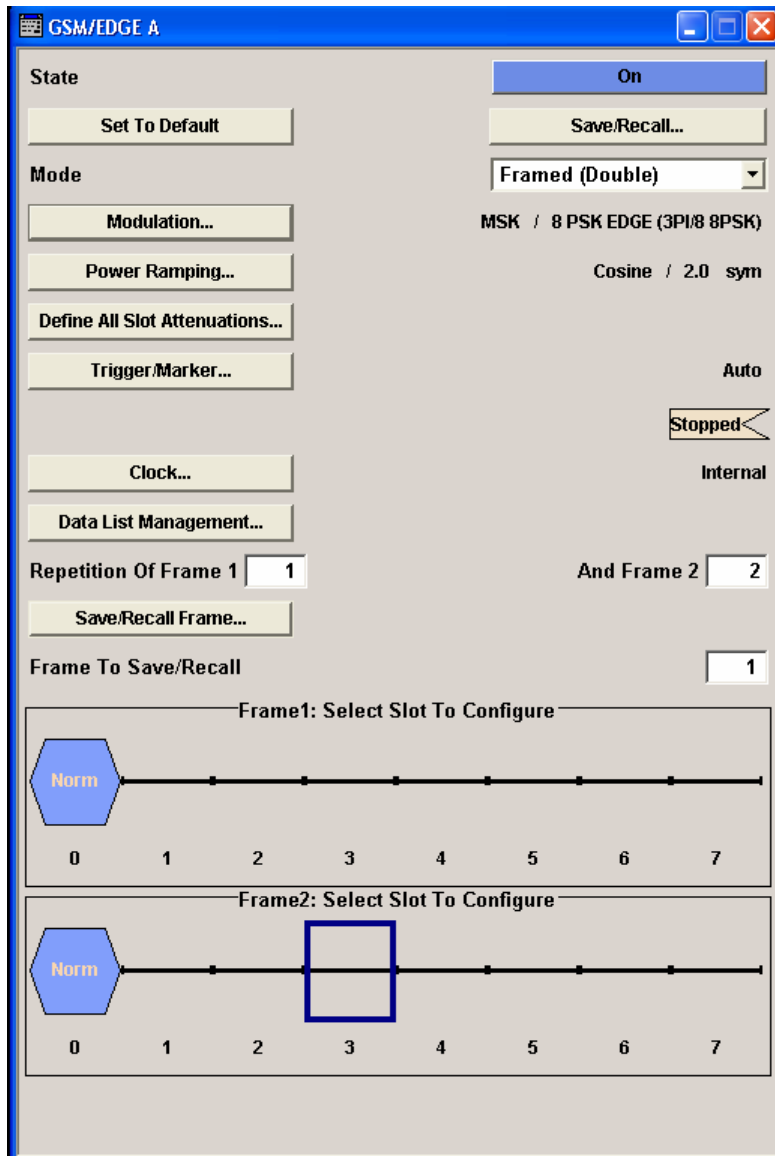

The following submenus are offered:

- For saving and loading a frame structure (see section "[Save Recall Frame/Slots - GSM/EDGE](#)", page 4.274).
- For selecting the modulation (see section "[Modulation - GSM/EDGE](#)", page 4.277).
- For selecting the trigger, marker and clock (see section "[Trigger/Marker/Clock - GSM/EDGE](#)", page 4.282).
- For power ramping (see section "[Power Ramping - GSM/EDGE](#)", page 4.279).
- For defining the attenuation (see section "[Power Ramping - GSM/EDGE](#)", page 4.279).

**Repetition of Frame - GSM/EDGE**

Enters the number of repetitions for frame 1 or frame 2. First frame 1 is repeated the specified number of times, then frame 2, then frame 1 starts again, and so on.

Remote-control commands:

```
SOUR:BB:GSM:FRAM1:REP 2
SOUR:BB:GSM:FRAM2:REP 10
```

## Save Recall Frame/Slots - GSM/EDGE

The **Save/Recall Frame** menu is accessed via the **GSM/EDGE** main menu.

The **Save/Recall Slots** menu is accessed via the **Burst Editor** sub menu.

When you call the submenu using the corresponding button a box opens from which you can select the function you require:

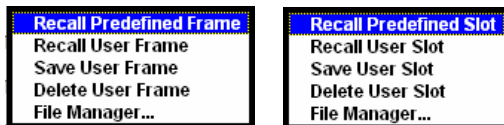

The **File Select** menus save and load (i.e. recall) user-defined frames or slots. Predefined frames or slots can also be recalled. Each menu offer access to the **File Manager** for general file management.

Predefined Frames and Slots are stored on a predefined path. This path is automatically set in the **File Select** window.

User-defined Frames and Slots are stored as files with the specific file extensions **\*.gsm\_fu** or **\*.gsm\_slu**, respectively. They can be stored in a user-determined directory and called from there.

It is not possible to use other file extensions. Attempting to do so will cause an error message. If the file extension is modified (e.g. by directly accessing the file system) the files are no longer recognized and therefore invalid.

When the **Framed (Double)** mode is active the frame to be saved is selected in line **Frame To Save/Recall**.

**Note:**

*In the following examples of commands the files are stored in the default directory which is defined by command **MMEM:CDIRECTORY**.*

**Recall Predefined  
Frame/Slot - GSM/EDGE**

Calls the **File Select** menu for loading a predefined frame/slot.

The following predefined frames are available:

- EDGE0: slot 0 = On, full level, EDGE burst, all other slots off
- EDGEAll: all slots On, full level, EDGE burst
- GsmEdge: alternately one slot with NORMAL burst and EDGE burst
- NormalBurst0: slot 0 = On, full level, NORMAL burst (full rate), all other slots off
- NormalBurstAll: all slots On, full level, NORMAL burst (full rate)

The following predefined slots are available:

- GSM\_NB\_PN9\_TSC0: NORMAL burst (full rate), full level, attenuation A1, multislot = Off, number of multislots = 1, Data = PRBS 9, Use Stealing Flag = On, TSC0, all slot-marker set to "all down".
- EDGE\_NB\_PN9\_TSC0: EDGE burst (full rate), full level, attenuation A1, multislot = Off, number of multislots = 1, Data = PRBS 9, Use Stealing Flag = On, TSC0, all slot-marker set to "all down".

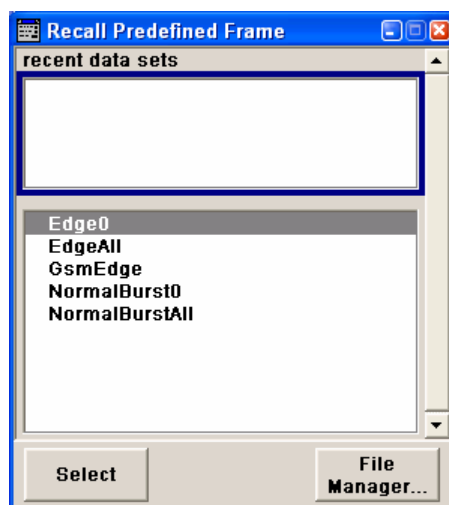

Remote-control command:

```
SOUR:BB:GSM:FRAM:PRED:CAT?
SOUR:BB:GSM:FRAM:PRED:LOAD "Edge0"
SOUR:BB:GSM:FRAM2:SLOT:PRED:CAT?
SOUR:BB:GSM:FRAM2:SLOT:PRED:LOAD 'EDGE_NB_PN9_TSC0'
```

**Recall User Frame/Slot - GSM/EDGE**

Calls the **File Select** menu for loading a user-defined frame/slot.

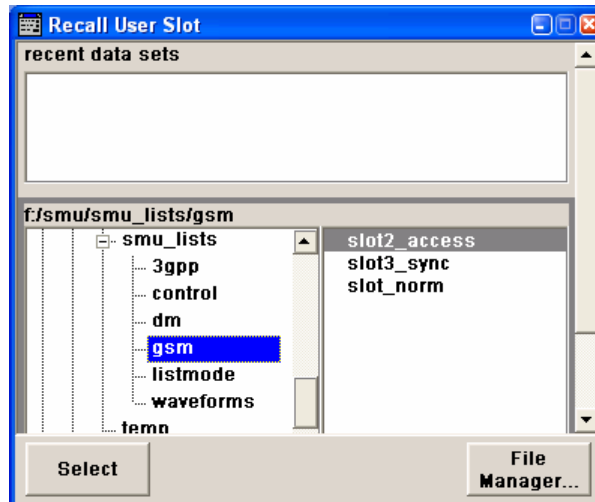

Remote-control command:

```
SOUR:BB:GSM:FRAM:ULIS:CAT?
SOUR:BB:GSM:FRAM:ULIS:LOAD "FRAM"
SOUR:BB:GSM:FRAM:SLOT:ULIS:CAT?
SOUR:BB:GSM:FRAM:SLOT:ULIS:LOAD "SLOT1"
```

**Save User Frame/Slot - GSM/EDGE**

Calls the **File Select** menu for saving the current frame or slot settings.

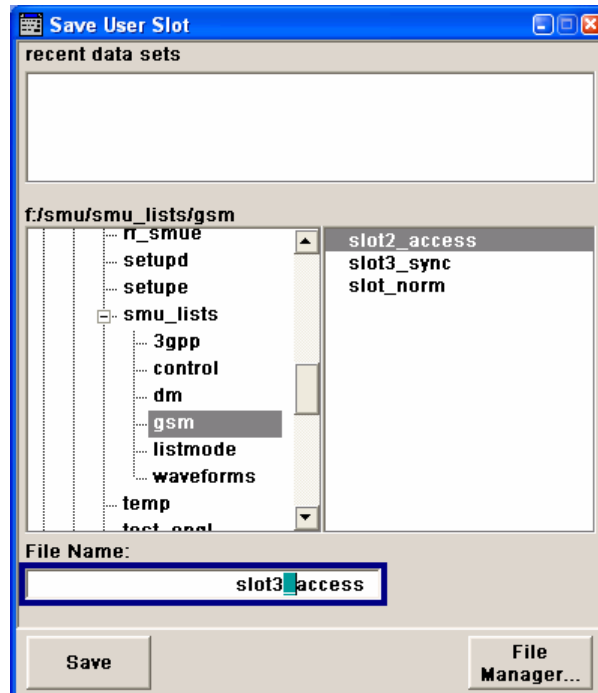

Remote-control command:

```
MMEM:MDIR 'F:\gen_lists\gsm'

SOUR:BB:GSM:FRAM:ULIS:STOR "FRAM1"
SOUR:BB:GSM:FRAM:SLOT:ULIS:STOR "SLOT1"
```



**File Manager - GSM/EDGE** Calls the **File Manager**.

The **File Manager** is used to copy, delete and rename files and to create new directories.

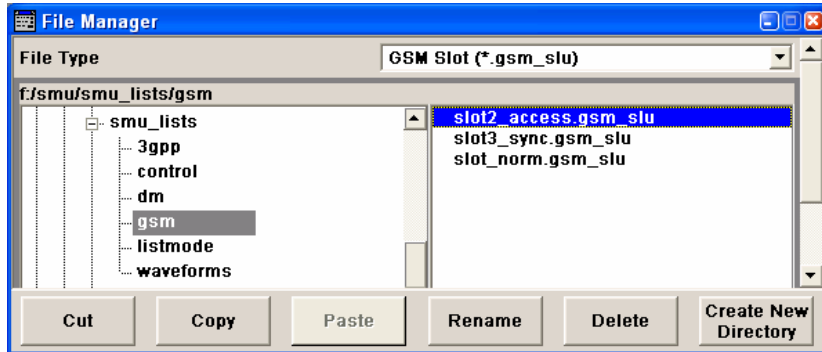

Remote-control commands:

```
MMEM:MDIR 'F:\gen_lists\gsm'
```

```
SOUR:BB:GSM:FRAM:ULIS:DEL 'd:\user\gsm\frame'
```

```
SOUR:BB:GSM:FRAM:SLOT:ULIS:DEL 'd:\user\gsm\slot'"
```

## Modulation - GSM/EDGE

The **Modulation** menu is accessed via the **GSM/EDGE** main menu.

In this menu the parameters that apply separately to the GSM and EDGE standards are brought together in either the **GSM** or the **EDGE** sections. The rest of the parameters apply to both modulation types.

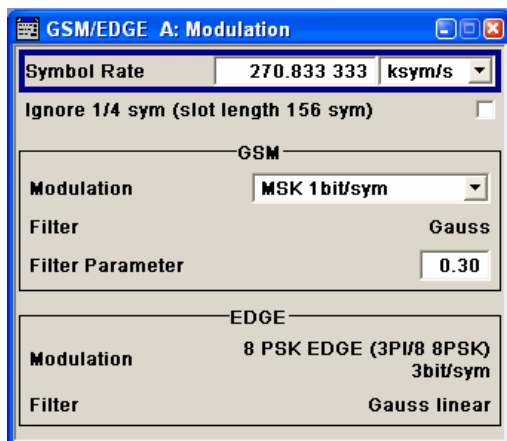

**Symbol Rate - GSM/EDGE** Sets the symbol rate. The default value for GSM/EDGE is 270.833 33 ksymb/s

Remote-control command:  
SOUR:BB:GSM:SRAT 270 kHz

**Ignore 1/4 symbol - GSM/EDGE**

Selects constant slot length. This setting affects all burst types.

The GSM slot has a length of 156.25 symbols. Compensation for the 1/4 symbol takes the form of an extra symbol every 4th slot. This means that some slots are 156 long and some are 157 long. Compensation takes place in the guard field of the burst (see section "[Burst Editor - GSM/EDGE](#)", page 4.292")

If the field **Ignore 1/4 symbol (slot length 156 symbols)** is enabled, all slots are 156 symbols long. The extra 1/4 symbol is omitted. The guard field for the burst always has the same length regardless of the slot index. A frame is therefore 1248 symbols long in place of 1250.

Remote-control command:  
SOUR:BB:GSM:ISL OFF | ON

The settings for Standard GSM are brought together in the **GSM** section.

**Modulation Type GSM - GSM/EDGE**

Selects modulation type for GSM signal.

**MSK 1bit/symbol** Minimum Shift Keying  
**FSK 1bit/symbol** Frequency Shift Keying

Remote-control command:  
SOUR:BB:GSM:FORM MSK | FSK2

**FSK Deviation- GSM/EDGE** Sets the deviation when selecting FSK.

When MSK is selected, the deviation is set permanently to symbol\_rate/4.

Remote-control command:  
SOUR:BB:GSM:FSK:DEV 67 KHZ

**Filter - GSM/EDGE**

Displays filter for GSM signal. The filter is permanently set to GAUSS.

Remote-control command:  
SOUR:BB:GSM:FILT:TYPE?  
Response: GAUSS

**Filter Parameter - GSM/EDGE**

Sets the BxT value for the GAUSS filter. The GSM default value is 0.3.

Remote-control command:  
SOUR:BB:GSM:FILT:PAR 0.3

The settings for Standard EDGE are brought together in the **EDGE** section.

### Modulation Type EDGE - GSM/EDGE

Displays modulation type for EDGE signal. The modulation type is set permanently to 8PSK EDGE ( $3\pi/8$  8PSK). Unlike the modulation types for GSM the modulation type for EDGE has 3 bits per symbol.

Remote-control command:

SOUR:BB:GSM:EDGE:FORM?

Response: P8ED

### Filter - GSM/EDGE

Displays filter for EDGE signal. The filter is permanently set to GAUSS linearized.

Remote-control command:

SOUR:BB:GSM:FILT:EDGE:TYPE?

Response: GAUSS

## Power Ramping - GSM/EDGE

The **Power Ramping** menu is accessed via the **GSM/EDGE** main menu.

This menu is used to enter the settings for power ramping and level attenuation.

The **Power Ramp Control** section is used for setting the power ramp envelope.

The **Slot Attenuations (Used in Burst Editors)** section is used to define seven possible values for level attenuation. These values can be selected from the burst editor for the slot currently being edited. An eighth value is permanently set to 0 dB and corresponds to the **Slot Level Full** setting in the burst editor.

The **Power Ramping/ Level Attenuation** section is used for restricting power ramping to the baseband signal.

**Ramp Time - GSM/EDGE**

Enters the power ramping rise time and fall time for a burst. The setting is expressed in symbols.

The transmitted power must not be switched abruptly at the start and end of a burst, because the switching operation would otherwise generate excessively strong non-harmonics; the switching operation is therefore stretched over several symbol clocks.

Remote-control command:

SOUR:BB:GSM:PRAM:TIME 2.5

**Ramp Function - GSM/EDGE**

Enters the form of the transmitted power during the switching operation, i.e. the shape of the rising and falling edges of the envelope.

**Linear**

The transmitted power rises and falls linear fashion.

Remote-control command:

SOUR:BB:GSM:PRAM:SHAP LIN

**Cosine**

The transmitted power rises and falls with a cosine-shaped edge. This gives rise to a more favorable spectrum than the **Linear** setting.

Remote-control command:

SOUR:BB:GSM:PRAM:SHAP COS

**Rise Delay - Power Ramp Control - GSM/EDGE**

Sets the offset in the rising edge of the envelope at the start of a burst. A positive value gives rise to a delay and a negative value causes an advance. The setting is expressed in symbols.

Remote-control command:

SOUR:BB:GSM:PRAM:RDEL -1

**Fall Delay - Power Ramp Control - GSM/EDGE**

Sets the offset in the falling edge of the envelope at the end of a burst. A positive value gives rise to a delay and a negative value causes an advance. The setting is expressed in symbols.

Remote-control command:

SOUR:BB:GSM:PRAM:FDEL 1

**Slot Attenuation A1 to A7 - GSM/EDGE**

The **Slot Attenuations (Used in Burst Editors)** section is used to define seven possible values for level attenuation. These values can be selected from the burst editor for the slot currently being edited. An eighth value is permanently set to 0 dB (it corresponds to **Slot Level = Full**).

**Slot Attenuation A1 to A7 - GSM/EDGE**

Enters seven different values for level attenuation.

The burst editor can be used to set the level attenuation for the 8 slots to one of these predefined values independently of one another.

The ability to set a sequence of slots purposely to different levels (loud - soft - loud) in order to measure transmission stability is a requirement of measurement recommendation 11.21 in the latest GSM version 8.6.09.

The burst editor is likewise used to assign the **Slot Level** attribute **Attenuated** to individual slots.

Remote-control command:

```
SOUR:BB:GSM:SATT2 12 dB
```

**Baseband Only - Power Ramp Control – GSM/EDGE**

Restricts power ramping to the baseband signal.

**Off**

Level attenuation is effected via the attenuator stages in the RF section; only the remaining part is attenuated in the baseband. The signal is issued at the RF output with the defined level values. This setting provides the best possible dynamic for bursted signals.

Remote-control command:

```
SOUR:BB:GSM:PRAM:BBON OFF
```

**On**

Level attenuation is effected in the baseband only. This setting is mandatory in the following cases:

- When only the baseband signal is issued at the I/Q outputs. It is thus ensured that, with power ramping active, this signal is output with the defined level values.
- When a baseband signal is applied to two RF paths. The RF paths having separate frequency and level settings, the remaining attenuation to be effected in the baseband would have to be different for the two paths and is therefore not possible.
- When a bursted baseband signal (GSM/EDGE) is combined with a continuous baseband signal (e.g. 3GPP) or a noise signal and both signals are applied to one RF path. Blanking in the RF paths is not suitable, because the RF section would not only blank the bursted signal of the first baseband but also the continuous signal of the second baseband or the noise signal.

Remote-control command:

```
SOUR:BB:GSM:PRAM:BBON ON
```

## Trigger/Marker/Clock - GSM/EDGE

The **Trigger/Marker/Clock** menu is used to enter settings for triggers, markers and clocks. The menu offers internal triggering as well as the two external trigger inputs TRIGGER 1 and 2. In the case of two-path instruments it also offers internal triggering by the second path.

### Note:

Additional marker settings are entered at the slot level (see section "[Burst Editor - GSM/EDGE](#)", page 4.292). For instance, at that level a data mask signal can be assigned to a marker connector. Such settings take effect when the marker signal "as defined in Slots" is selected.

### Tip:

When synchronizing the R&S Vector Signal Generator to an external GSM frame sync signal, the following settings are recommended:

- Trigger Mode = Armed\_Auto
- Trigger Source = External Clock
- Clock Source = External
- Clock Mode = Fractional Symbol
- Symbol Clock Divider = 1250

The external GSM frame sync signal must be provided only at the clock input.

The **Trigger/Marker/Clock** menu is accessed via the **GSM/EDGE** main menu.

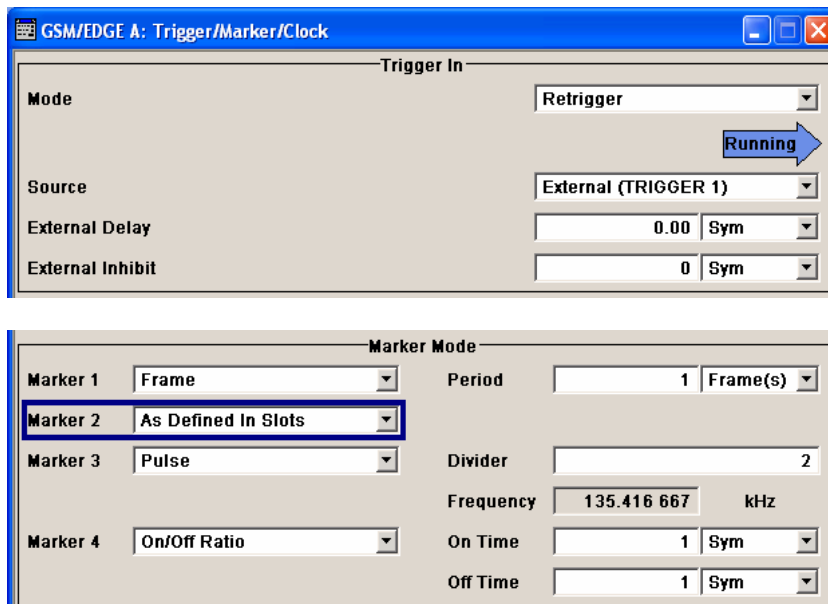

The **Trigger In** section is where the trigger for the GSM/EDGE signal is set. Various parameters will be provided for the settings, depending on which trigger source - internal or external - is selected. The current status of signal generation (**Running** or **Stopped**) is indicated for all trigger modes.

The **Marker Mode** section is where the marker signals at the MARKER output connectors are configured.

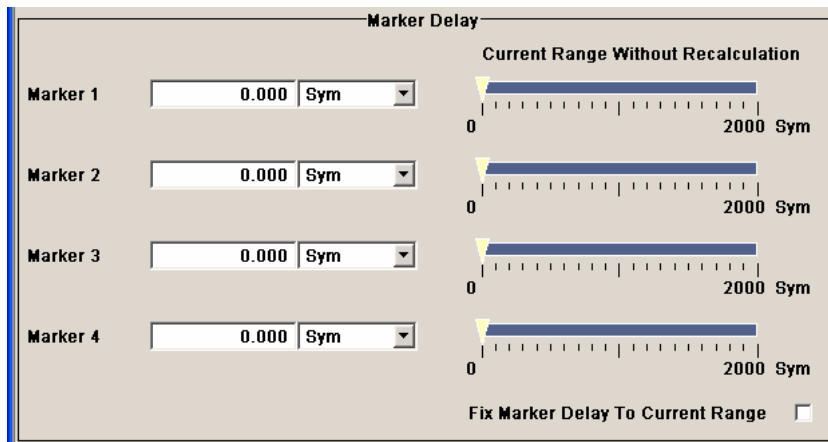

The **Marker Delay** section is where a marker signal delay can be defined, either without restriction or restricted to the dynamic section, i.e., the section in which it is possible to make settings without restarting signal and marker generation.

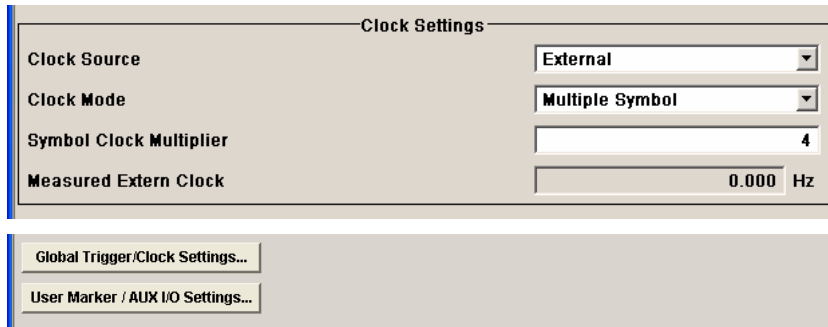

The **Clock Settings** section is where the clock source is selected and - in the case of an external source - the clock type.

The **Global Trigger/Clock Settings** button leads to a submenu for general trigger and clock settings.

The **User marker / AUX I/O Settings** button leads to a submenu for mapping the AUX I/O connector on the rear of the instrument.

The **Trigger** section is used to configure the trigger signal for generating the GSM/EDGE signal. The current status of signal generation is indicated for all trigger modes.

**Trigger Mode - GSM/EDGE** Selects trigger mode.

The trigger mode determines the effect of a trigger on the signal generation.

**Auto** The GSM/EDGE signal is generated continuously.

Remote-control command:  
SOUR:BB:GSM:SEQ AUTO

**Retrigger** The GSM/EDGE signal is generated continuously. A trigger event (internal or external) causes a restart.

Remote-control command:  
SOUR:BB:GSM:SEQ RETR

<b>Armed_Auto</b>	<p>The GSM/EDGE signal is generated only when a trigger event occurs. Then the GSM/EDGE signal is generated continuously.</p> <p>Button <b>Arm</b> stops signal generation. A subsequent trigger event (internal with <b>Execute Trigger</b> or external) causes a restart.</p> <p>Remote-control command: SOUR:BB:GSM:SEQ AAUT</p>
<b>Armed_Retrigge</b>	<p>The GSM/EDGE signal is generated only when a trigger event occurs. Then the signal is generated continuously. Every subsequent trigger event causes a restart.</p> <p>Button <b>Arm</b> stops signal generation. A subsequent trigger event (internal with <b>Execute Trigger</b> or external) causes a restart.</p> <p>Remote-control command: SOUR:BB:GSM:SEQ ARET</p>
<b>Single</b>	<p>The GSM/EDGE signal is output only when a trigger event occurs. Then the signal is output once in the length specified in <b>Signal Length</b>. Every subsequent trigger event (internal with <b>Execute Trigger</b> or external) causes a restart.</p> <p>Remote-control command: SOUR:BB:GSM:SEQ SING</p>
<b>Signal Duration Unit - GSM/EDGE</b>	<p>Defines the unit for the entry of the length of the signal sequence to be output in the <b>Single</b> trigger mode. Available units are symbols or frames.</p> <p>Remote-control commands: SOUR:BB:GSM:TRIG:SLUN SYMB</p>
<b>Signal Duration - GSM/EDGE</b>	<p>Enters the length of the signal sequence to be output in the <b>Single</b> trigger mode. The unit of the entry is defined under <b>Signal Duration Unit</b>. It is possible to output deliberately just part of the frame, an exact sequence of the frame, or a defined number of repetitions of the frame.</p> <p>Remote-control commands: SOUR:BB:GSM:TRIG:SLEN 200</p>



**Running - Stopped -  
GSM/EDGE**

Displays the status of signal generation for all trigger modes. This display appears only when GSM/EDGE modulation is enabled (**State On**).

Remote-control command:

SOUR:BB:GSM:TRIG:RMOD?

Response: RUN or STOP

**Running**

The GSM/EDGE signal is generated; a trigger was (internally or externally) initiated in triggered mode. If **Armed\_Auto** and **Armed\_Retrigger** have been selected, generation of signals can be stopped with the **Arm** button. A new trigger (internally with **Execute Trigger** or externally) causes a restart.

**Stopped**

The signal is not generated, and the instrument waits for a trigger event (internal or external).

**Arm - GSM/EDGE**

Stops GSM/EDGE signal generation. This button appears only with **Running** signal generation in the **Armed\_Auto** and **Armed\_Retrigger** trigger modes.

Signal generation can be restarted by a new trigger (internally with **Execute Trigger** or externally).

Remote-control command:

SOUR:BB:GSM:TRIG:ARM:EXEC

**Execute Trigger -  
GSM/EDGE**

Executes trigger manually. A manual trigger can be executed only when an internal trigger source and a trigger mode other than Auto have been selected.

Remote-control commands:

SOUR:BB:GSM:TRIG INT

SOUR:BB:GSM:SEQ RETR

SOUR:BB:GSM:TRIG:EXEC

**Trigger Source -  
GSM/EDGE**

Selects trigger source. This setting is effective only when a trigger mode other than Auto has been selected.

**Internal**

The trigger event is executed by **Execute Trigger**.

Remote-control command:

SOUR:BB:GSM:TRIG INT

**Internal  
(Baseband A/B)**

The trigger event is executed by the trigger signal from the second path (two-path instruments only).

Remote-control command:

SOUR:BB:GSM:TRIG:SOUR OBAN

**External  
(TRIGGER 1/2)**

The trigger event is executed with the aid of the active edge of an external trigger signal. The trigger signal is supplied via the TRIGGER 1 or TRIGGER 2 connector.

The polarity, the trigger threshold and the input impedance of the TRIGGER input can be set in the **Global Trigger/Clock Settings** menu.

Remote-control command:

```
SOUR:BB:GSM:TRIG:SOUR EXT | BEXT
```

**External Clock**

The trigger event is executed with the aid of the external clock signal. The signal is supplied via the CLOCK connector and is also used as clock.

**External Clock** is only available for baseband path A and if **Clock Source = External** is selected.

Remote-control command:

```
SOUR:BB:GSM:TRIG:SOUR ECL
```

**Trigger- Clock Delay -  
GSM/EDGE**

Sets trigger signal delay in symbols on external triggering via trigger or clock input or on internal triggering via the second path.

This enables the R&S Vector Signal Generator to be synchronized with the device under test or other external devices.

**Note**

*The delay can be set separately for each of the two paths.*

Remote-control command:

```
SOUR:BB:GSM:TRIG:EXT1:DEL 3
SOUR:BB:GSM:TRIG:OBAS:DEL 3
SOUR:BB:GSM:TRIG:EXT:CLOC:DEL 3
```

**Trigger- Clock Inhibit -  
GSM/EDGE**

Sets the duration for inhibiting a new trigger event subsequent to triggering. The input is to be expressed in symbols.

In the **Retrigger** mode every trigger signal causes signal generation to restart. This restart is inhibited for the specified number of symbols:

This parameter is only available on external triggering via trigger or clock input or on internal triggering via the second path.

**Note:**

*The trigger inhibit can be set separately for each of the two paths.*

Remote-control command:

```
SOUR:BB:GSM:TRIG:EXT2:INH 1000
SOUR:BB:GSM:TRIG:OBAS:INH 1000
SOUR:BB:GSM:TRIG:EXT:CLOC:INH 1000
```

The signal on the MARKER outputs is configured in the **Marker Settings** section.

### Marker x Mode - GSM/EDGE

Selects a marker signal for the associated MARKER output.

**As defined in Slots** The marker defined for each slot separately in the burst editor is used. The name of the marker is displayed to the right of the selection. Definition of the slot marker is described in section "[Slot Marker Definition - GSM/EDGE](#)", page 4.304.

Remote Control Command:

```
SOUR:BB:GSM:TRIG:OUTP1:MODE SDEF
```

### Slot

A slot clock with the slot period specified under **Period** is generated on the output connector. The marker signal is generated after every specified number of slots.

Period  Slot(s) ▾

It is important to be aware of the variation in the GSM/EDGE slot length between 156 and 157 symbols. At a slot length of 156 symbols, a period of 1 symbol and a symbol rate of 270.833 ksymb/s the clock is 0.577 ms, and at 157 symbols it is 0.580 ms.

Remote-control command:

```
SOUR:BB:GSM:TRIG:OUTP1:MODE SLOT
SOUR:BB:GSM:TRIG:OUTP1:PER:SLOT 444
```

### Frame

A frame clock with the frame period specified under **Period** is generated on the output connector. The marker signal is generated after every specified number of frames.

Period  Frame(s) ▾

A GSM/EDGE frame has 1250 symbols. At a symbol rate of 270.833 ksymb/s and a period of 1 the clock is 4.615 ms.

Remote-control command:

```
SOUR:BB:GSM:TRIG:OUTP1:MODE FRAM
SOUR:BB:GSM:TRIG:OUTP1:PER 444
```

**Pulse**

A regular marker signal is generated. The pulse frequency is defined by entering a divider. The frequency is derived by dividing the sample rate by the divider. The input box for the divider opens when **Pulse** is selected, and the resulting pulse frequency is displayed below it.

Divider	<input type="text" value="2"/>
Frequency	<b>135.416 667</b> kHz

The maximum pulse frequency is half the symbol rate.

Remote-control command:

```
SOUR:BB:GSM:TRIG:OUTP1:MODE PULS
SOUR:BB:GSM:TRIG:OUTP1:PULS:DIV 4
SOUR:BB:GSM:TRIG:OUTP1:PULS:FREQ?
```

**Pattern**

A marker signal that is defined by a bit pattern is generated. The pattern has a maximum length of 64 bits and is defined in an input field which opens when **pattern** is selected.

Period	<input type="text" value="1000 0000 0000 1111 1111"/>
Period	<input type="text" value="1111 1111 1000 0000 0000"/>
Period	<input type="text" value="0000 0011 1111 1111 1111"/>

Remote-control command:

```
SOUR:BB:GSM:TRIG:OUTP1:MODE PATT
SOUR:BB:GSM:TRIG:OUTP1:PATT #H8E3,12
```

**ON/OFF ratio**

A regular marker signal that is defined by an ON/OFF ratio is generated. A period lasts one ON and OFF cycle.

Start of signal

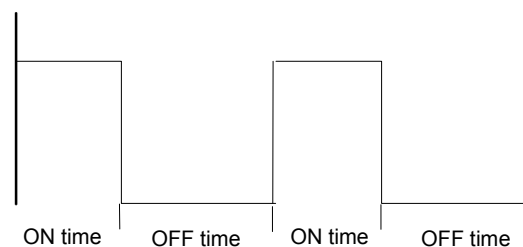

The ON time and OFF time are each expressed as a number of symbols and are set in an input field which opens when **ON/OFF ratio** is selected.

On Time	<input type="text" value="2"/>	Sym
Off Time	<input type="text" value="3"/>	Sym

Remote-control command:

```
SOUR:BB:GSM:TRIG:OUTP1:MODE RAT
SOUR:BB:GSM:TRIG:OUTP1:OFFT 20
SOUR:BB:GSM:TRIG:OUTP1:ONT 20
```

The delay of the signals on the MARKER outputs is set in the **Marker Delay** section.

**Marker x Delay -  
GSM/EDGE**

Enters the delay between the marker signal at the marker outputs and the start of the frame or slot.

The input is expressed as a number of symbols. If the setting "**Fix marker delay to dynamic range**" is enabled, the setting range is restricted to the dynamic range. In this range the delay of the marker signals can be set without restarting the marker and signal.

Remote-control command:

SOUR:BB:GSM:TRIG:OUTP2:DEL 2

**Current Range without  
Recalculation - GSM/EDGE**

Displays the dynamic range within which the delay of the marker signals can be set without restarting the marker and signal.

The delay can be defined by moving the setting mark.

Remote-control command:

SOUR:BB:GSM:TRIG:OUTP2:DEL:MAX?

SOUR:BB:GSM:TRIG:OUTP2:DEL:MIN?

**Fix marker delay to current  
range - GSM/EDGE**

Restricts the marker delay setting range to the dynamic range. In this range the delay can be set without restarting the marker and signal.

Remote-control command:

SOUR:BB:GSM:TRIG:OUTP:DEL:FIX ON

The **Clock Settings** is used to set the clock source and a delay if required.

**Clock Source - GSM/EDGE** Selects the clock source.

**Internal**

The internal clock reference is used to generate the symbol clock.

Remote-control command:

SOUR:BB:GSM:CLOC:SOUR INT

**External** The external clock reference is fed in as the symbol clock or multiple thereof via the CLOCK connector.

The symbol rate must be correctly set to an accuracy of  $\pm 2\%$  (see data sheet).

The polarity of the clock input can be changed with the aid of **Global Trigger/Clock Settings**.

In the case of two-path instruments this selection applies to path A.

Remote-control command:  
SOUR:BB:GSM:CLOC:SOUR EXT

**Clock Mode - GSM**

Enters the type of externally supplied clock.

**Symbol** A symbol clock is supplied via the CLOCK connector.

Remote-control command:  
SOUR:BB:GSM:CLOC:MODE SYMB

**Bit** A bit clock is supplied via the CLOCK connector; the symbol clock is derived internally from this.

Remote-control command:  
SOUR:BB:GSM:CLOC:MODE BIT

**Multiple Symbol** A multiple of the symbol clock is supplied via the CLOCK connector; the symbol clock is derived internally from this.

Remote-control command:  
SOUR:BB:GSM:CLOC:MODE MSYM

**Fractional Symbol** A fraction of the symbol clock is supplied via the CLOCK connector; the symbol clock is derived internally from this.

**Note:**

*This selection is only available for external clock signals with a clock rate of at least 200 Hz.*

Remote-control command:  
SOUR:BB:GSM:CLOC:MODE FSYM

<b>Symbol Clock Multiplier - GSM/EDGE</b>	<p>Enters the multiplication factor for clock type <b>Multiple</b>.</p> <p>Remote-control command: SOUR:BB:GSM:CLOC:MULT 4</p>
<b>Symbol Clock Divider - GSM/EDGE</b>	<p>Enters the divider for clock type <b>Fraction</b>.</p> <p>Remote-control command: SOUR:BB:GSM:CLOC:DIV 4</p>
<b>Measured External Clock - GSM/EDGE</b>	<p>Indicates the measured frequency of the external clock signal. This enables the user to permanently monitor the frequency of the externally introduced clock.</p> <p>This information is displayed only if the external clock source has been selected.</p> <p>Remote-control command: :CLOC:INP:FREQ?</p>
<b>Global Trigger-Clock Settings- GSM/EDGE</b>	<p>Calls the <b>Global Trigger/Clock/Input Settings</b> menu. This menu is used among other things for setting the trigger threshold, the input impedance and the polarity of the clock and trigger inputs.</p> <p>In the case of two-path instruments these settings are valid for both paths.</p> <p>The parameters in this menu affect all digital modulations and standards, and are described in the section "<a href="#">Global Trigger/Clock/Input Settings – Setup -Environment</a>".</p>

## Burst Editor - GSM/EDGE

To call the burst editor, select a slot from the graphical display in the GSM/EDGE menu.

At the top of the menu the structure of the current burst type for the selected slot is displayed (in this example Normal (Half Rate)). Individual fields of the burst are colour-coded:

Field	Colour
Data, Fixed, Mixed, Stealing	white
Training Sequences: TSC, ETSC, SYNC	yellow
Tail, extended Tail	green
Guard, extended Guard	blue

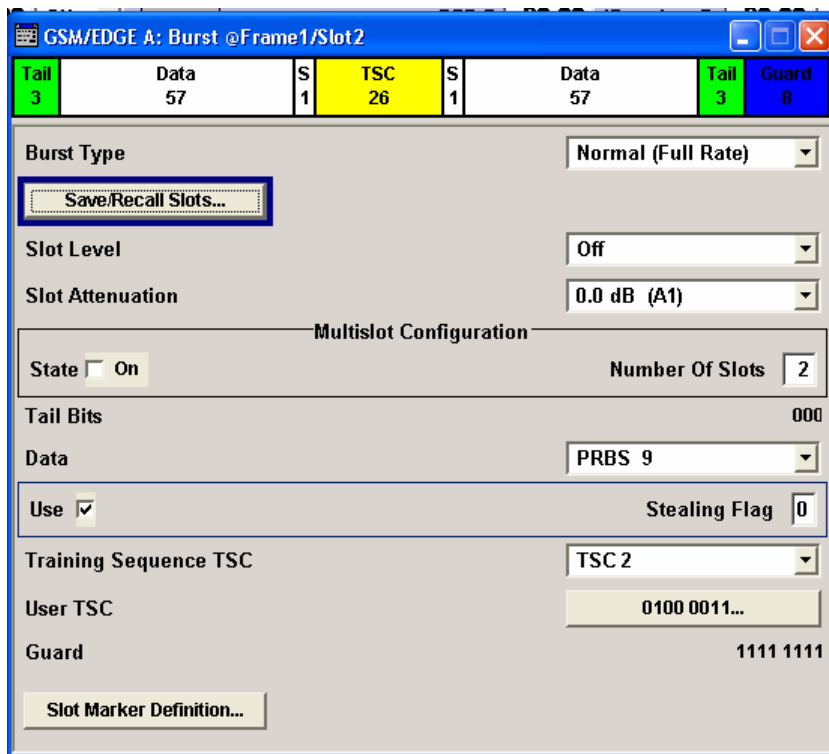

The rest of the menu displays the data contained in fields predefined by the standard for the current burst type. Data fields with variable content can be edited. The value at which they are currently set is shown on a button. Pressing the button activates the value that has been entered (in this example: User TSC). Values in fields with permanently predefined content are not highlighted in any way (in this example: Guard). The following sections list **all** possible settings and displays for the various burst types. If a setting applies only to a particular burst type, this is mentioned for the parameter concerned.



**Burst Type - GSM/EDGE** Selects burst type.

**Normal (Full Rate)**

The useful data is transmitted in the Normal burst.

Tail	Data	S	TSC	S	Data	Tail	Guard
3	57	1	26	1	57	3	9

Remote-control command:

SOUR:BB:GSM:FRAM:SLOT2:TYPE NORM

**Normal (Half Rate)**

The useful data is transmitted in the Normal burst.

Half rate user 1 is transmitted in all the frames with an even index (frames 0, 2, 4, etc.) and half rate user 2 is transmitted in the frames with an odd index (frames 1, 3, etc.). (see also section "[Mode Framed \(single\) - GSM/EDGE](#)", page 4.270).

User 1							
Tail	Data	S	TSC	S	Data	Tail	Guard
3	57	1	26	1	57	3	9
User 2							
Tail	Data	S	TSC	S	Data	Tail	Guard
3	57	1	26	1	57	3	9

Burst Type: Normal (Half Rate)

Remote-control command:

SOUR:BB:GSM:FRAM:SLOT2:TYPE HALF

**EDGE**

The higher bit clock associated with EDGE achieves correspondingly higher data transfer rates.

If a frame contains an active EDGE burst, the higher bit clock (3 x symbol clock) is always output on the clock outputs. If the EDGE burst is removed from the frame, the lower bit clock (=symbol clock) is automatically output again.

Tail	Data	TSC	Data	Tail	Guard
9	174	78	174	9	27

Burst Type: EDGE

Remote-control command:

SOUR:BB:GSM:FRAM:SLOT2:TYPE EDGE

**Synchronization** The Synchronization burst is sent by the base station only and is used for bit synchronization. For this purpose it contains a 64-bit Extended Training Sequence.

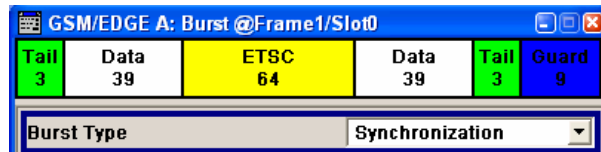

Remote-control command:

SOUR:BB:GSM:FRAM:SLOT1:TYPE SYNC

### Frequency Correction

The Frequency Correction burst is sent by the base station only. The user equipment uses the burst in order to synchronize with the carrier frequency and to compensate for any possible Doppler effect.

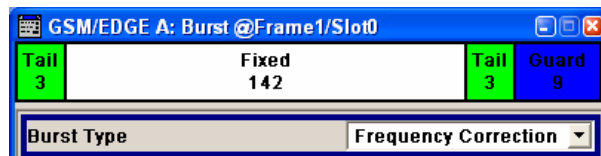

Remote-control command:

SOUR:BB:GSM:FRAM:SLOT0:TYPE FCOR

### Dummy

The Dummy burst is sent by the base station only. It acts as a modulation signal when there is no data burst available. This burst type is defined in the standard and has an unalterable, precisely defined data pattern.

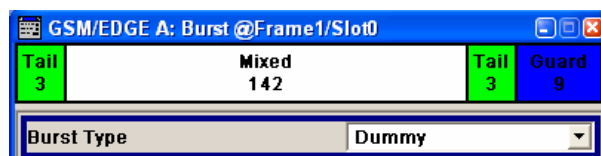

Remote-control command:

SOUR:BB:GSM:FRAM:SLOT0:TYPE DUMM

**Access**

This burst type is sent by a user equipment to a base station as the first burst, in order to determine the timing advance. It is used for synchronizing with the base station.

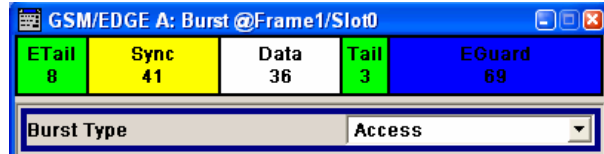

Remote-control command:

```
SOUR:BB:GSM:FRAM:SLOT1:TYPE ACC
```

**All Data GSM**

This and the following burst type are not defined in the standard. They serve as the output basis for defining a new burst type with user-programmable data content for test purposes.

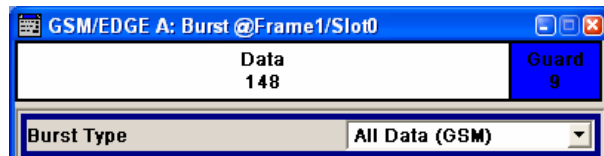

Remote-control command:

```
SOUR:BB:GSM:FRAM:SLOT4:TYPE ADAT
```

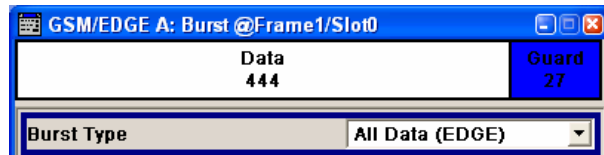
**All Data EDGE**

Remote-control command:

```
SOUR:BB:GSM:FRAM:SLOT4:TYPE AEDG
```

**Save-Recall Slots - GSM/EDGE**

Calls the **Save/Recall Slot** menu.

From the **Save/Recall Slot** menu the **File Select** windows for saving and recalling slot configurations and the **File Manager** can be called (see section "[Save Recall Frame/Slots - GSM/EDGE](#)" page 4.274).



Remote-control command: n.a.

**User x - GSM/EDGE**

When burst type **Normal (Half Rate)** is selected the users can be set separately in menu sections User 1 and User 2.

Remote-control command: n.a.

(The user is selected by suffix in the case of  
 SOUR:BB:GSM:FRAM:SLOT:USER< [ 1 ] | 2 >)

**Slot Level - GSM/EDGE**

Sets the level for the selected slot.

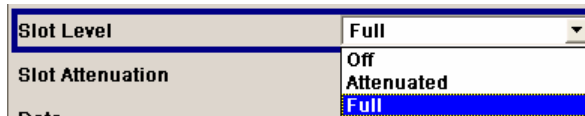

**Off** Attenuation is maximum. The slot is inactive.

Remote-control command:

SOUR:BB:GSM:FRAM:SLOT2:LEV OFF

**Attenuated** Level is reduced by the level attenuation set in **Slot Attenuation**.

Remote-control command:

SOUR:BB:GSM:FRAM:SLOT2:LEV ATT

**Full** The level corresponds to the level indicated in the display.

Remote-control command:

SOUR:BB:GSM:FRAM:SLOT2:LEV FULL

**Slot Attenuation -  
GSM/EDGE**

Selects the level attenuation for the **Slot Level Attenuated** setting. You can use the Power Ramping menu (see "[Power Ramping - GSM/EDGE](#)", page 4.279) to define seven different values for level attenuation. You may select from the values displayed.

Remote-control command:

```
SOUR:BB:GSM:FRAM1:SLOT2:ATT A1
```

You can use the **Multislot Configuration** section to switch on and configure multislot mode. This section is available only when you select Normal (Full Rate) burst and EDGE burst.

**Multislot Configuration -  
GSM/EDGE**

Enables the previously set multislot mode.

Since multislot involves connecting multiple slots to a single user channel, this configuration is possible only for Normal (Full Rate) bursts and EDGE bursts.

A number of multislot groups can be defined within a frame. These are highlighted when the frame structure is displayed in the main menu (see chapter "[Mode Framed \(single\) - GSM/EDGE](#)", page 4.270).

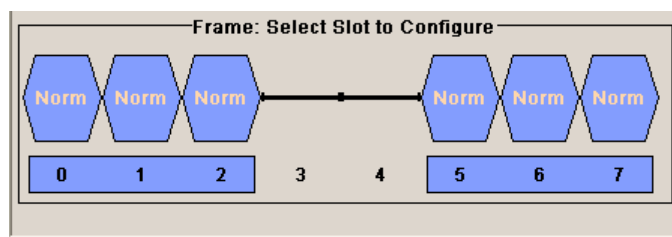

The first slot in a multislot group is the master slot. This determines the parameters of all the slots in the group. All the slots in a multislot group therefore have identical parameters.

The multislot settings are valid for all the slots in the frames of a multiframe configuration. If slots 1 and 2 are connected, for example, both these slots are connected in all the frames of the multiframe signal.

Remote-control command:

```
SOUR:BB:GSM:FRAM:MULT3:STAT ON
```

**Number of Slots-  
GSM/EDGE**

Defines the number of consecutive slots that will be linked to a multislot.

The multislot always starts with the current slot. The value range therefore depends on the current slot index. A maximum of 8 slots (slot 0 to slot 7) can be combined: 1 ... (8 - current index).

Remote-control command:

```
SOUR:BB:GSM:FRAM:MULT3:COUN 3
```

<b>Extended Tail Bits - GSM/EDGE</b>	<p>Displays the data content in the "ETail" data field of the Access burst.</p> <p>Extended Tail Bits fields are 8 bits long and permanently set at 0011 1010.</p> <p>Remote-control command: n.a.</p>
<b>Tail Bits - GSM/EDGE</b>	<p>Displays the data content in the "Tail" data field.</p> <p>The GSM Tail Bit field is 3 bits long and permanently set at 000.</p> <p>The EDGE Tail Bit field is 9 bits long and permanently set at 1111 1111 1.</p> <p>Remote-control command: n.a.</p>
<b>Data for Data Field of Slot - GSM/EDGE</b>	<p>Selects a data source for the DATA field.</p> <p>If a burst contains multiple DATA fields, these are treated as a continuous field, and for instance a pseudo-random sequence is continued without interruption from one DATA field to the next.</p> <p>You may choose from the following data sources:</p> <p><b>All 0</b>                      0 data or 1 data is internally generated.</p> <p><b>All 1</b>                      Remote-control command:  SOUR:BB:GSM:FRAM:SLOT:SOUR:DATA ALL0    ALL1</p> <p><b>PRBS</b>                      PRBS data in accordance with the IUT-T with period lengths between <math>2^9-1</math> and <math>2^{23}-1</math> are internally generated.</p> <p>Remote-control commands:  SOUR:BB:GSM:FRAM:SLOT:SOUR:DATA PN9    PN11   PN15   PN16   PN20   PN21   PN23</p> <p><b>Pattern</b>                      A user-definable bit pattern with a maximum length of 64 bits is internally generated.</p> <p>The bit pattern is defined in the <b>Pattern</b> input box.</p> <p>Remote-control command:  SOUR:BB:GSM:FRAM:SLOT:SOUR:DATA PATT  SOUR:BB:GSM:FRAM:SLOT:SOUR:DATA:PATT  #H8C, 8</p>

**Data List**

Uses data from a programmable data list. The data can be generated internally with the aid of the binary editor in the R&S Vector Signal Generator or externally by the user with the aid of any editor. Data lists are selected from the **Select List** file menu.



Remote-control command:

```
SOUR:BB:GSM:FRAM:SLOT:SOUR:DATA DLIS
SOUR:BB:GSM:FRAM:SLOT:SOUR:DATA:DLIS
'GSM'
```

**Use Stealing Flag - GSM/EDGE**

Sets the Use Stealing Flag feature. The setting applies to both S fields. If not used, the flag stealing bit is allocated to the data field concerned, which then becomes 58 data bits long instead of 57.

Remote-control command:

```
SOUR:BB:GSM:FRAM:SLOT2:SFL:USE ON
```

**Stealing Flag - GSM/EDGE**

Sets a value for the Stealing Flag feature. The setting applies to both S fields.

Remote-control command:

```
SOUR:BB:GSM:FRAM:SLOT2:SFL 0 | 1
```

**Training Sequence TSC - GSM/EDGE**

Selects the "Training Sequence Code".

There are 8 predefined training sequences to choose from in each case; those for GSM are 26 bits long and those for EDGE are 78 bits.

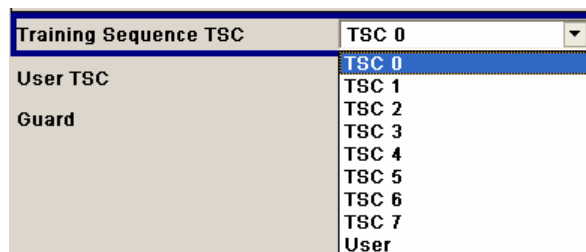

A user-defined training sequence can be created in the **User TSC** field and is then also available for selection.

Remote-control command:

```
SOUR:BB:GSM:FRAM:SLOT2:TSC:SEL T0 |...| T7 | USER
```

**User TSC - GSM/EDGE**

Edits selected training sequence.

When a sequence has been changed, the **TSC** field displays the indication "**USER**".

When a frame/slot is saved the amended training sequence is also saved.

User-defined training sequences can be used among other things to test the reaction of receivers to interference-laden training sequences (e.g. 1 bit toggle).

Remote-control command:

```
SOUR:BB:GSM:FRAM:SLOT2:SOUR:TSC:USER #H3FFFFFF
```

**Ext Training Seq ETSC - GSM/EDGE**

Selects the Extended Training Sequence Code for the Synchronization burst.

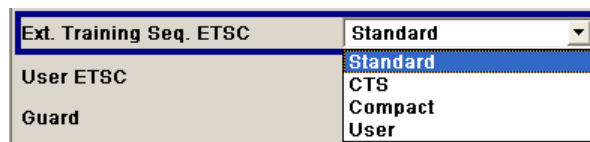

There is a choice of three predefined, 64-bit extended training sequences. Additionally a user-defined extended training sequence can be defined in the **User ETSC** field and is then also available for selection.

Remote-control command:

```
SOUR:BB:GSM:FRAM:SLOT2:ETSC STAN
```

**User ETSC - GSM/EDGE**

Edits selected ETSC for the Synchronization burst.

When a sequence has been changed, the **Ext Training Seq ETSC** field also displays **User** as a possible choice.

When a frame/slot is saved, the changed extended training sequence is also saved.

Remote-control command:

```
SOUR:BB:GSM:FRAM:SLOT2:ETSC USER
```

(input of pattern is only possible via manual control)



**Training Sequence Sync - GSM/EDGE**

Selects Training Sequence Sync for the Access burst.

Training Sequence Sync	TS 0
User Sync	TS 0
Data	TS 1
	TS 2
	User

There is a choice of three predefined, 41-bit training sequences sync. Additionally a user-defined training sequence sync can be defined in the **User Sync** field and is then also available for selection.

Remote-control command:

```
SOUR:BB:GSM:FRAM:SLOT2:SYNC:SEL T0 |T1 | T2 | USER
```

**User Sync - GSM/EDGE**

Edits the Training Sequence Sync for the Access burst.

When a sequence has been changed, the **Training Sequence Sync** field also displays "**User**" as a possible choice.

When a frame/slot is saved the amended training sequence sync is also saved.

Remote-control commands:

```
SOUR:BB:GSM:FRAM:SLOT2:SYNC:SEL USER
```

```
SOUR:BB:GSM:FRAM:SLOT2:SYNC:USER #FFFFFFFFF0,41
```

**Fixed - GSM/EDGE**

Selects the data content of the Fixed field in the Frequency Correction burst. There is a choice of two fixed, 142-bit data contents prescribed by the standard. The **User** data content can also be selected. This pattern can be edited in the Fixed Pattern field and must likewise be 142 bits long.

Fixed	Standard
Fixed Pattern	Standard
Guard	Compact
	User

Remote-control command:

```
SOUR:BB:GSM:FRAM:SLOT2:FCOR:FIX COMP
```

**Fixed Pattern - GSM/EDGE** Displays the data content of the Fixed field in the Frequency Correction burst when **Fixed Standard** or **Compact** is selected.

Enter the data content of the Fixed field in the Frequency Correction burst when **Fixed User** is selected. The pattern is 142 bits long.

<b>Fixed Pattern</b>	0000 0000 0000 0000 0000
<b>Guard</b>	0000 0000 0000 0000 0000
	0000 0000 0000 0000 0000
	0000 0000 0000 0000 0000
	0000 0000 0000 0000 0000
	0000 0000 0000 0000 0000
	00

Remote-control command:

SOUR:BB:GSM:FRAM:SLOT2:FCOR:FIX USER

SOUR:BB:GSM:FRAM:SLOT2:FCOR:FIX:PATT #B0,142

**Mixed - GSM/EDGE**

Displays the data content of the Mixed field in the Dummy burst. It contains a fixed, 142-bit data content prescribed by the standard.

<b>Mixed</b>	1111 1011 0111 0110 0000
<b>Guard</b>	1010 0100 1110 0000 1001
	0001 0000 0001 1111 0001
	1100 0101 1100 0101 1100
	0101 0111 0100 1010 0011
	0011 0011 1001 1110 1001
	1111 0001 0010 1111 1010
	10

Remote-control command:

SOUR:BB:GSM:SLOT1:DUMM:MIX:PATT?

**Guard - GSM/EDGE**

Displays the data content of the Guard field in binary notation.

In order for a frame to contain exactly 1250 bits as prescribed in the GSM standard, the length of the Guard fields is different for different slots:

**GSM:**

The field length is 8 bits in slots 1, 2, 3, 5, 6, 7 and 9 bits in slots 0 and 4.

**EDGE:**

The field length is 24 bits in slots 1, 2, 3, 5, 6, 7 and 27 bits in slots 0 and 4.

If the field **Ignore 1/4 symbol (slot length 156 symbols)** (page 4.277) is enabled, all slots are 156 symbols long. The extra  $\frac{1}{4}$  symbol is omitted. The guard field for the burst always has the same length regardless of the slot index. A frame is therefore 1248 symbols long in place of 1250.

Remote-control command: n.a.

**Extended Guard - GSM/EDGE**

Displays the data content of the Extended Guard field in the Access burst.

In order for a frame to contain exactly 1250 symbols as prescribed in the GSM standard, the length of the extended Guard fields is different for different slots:

The field length is 68 bits in slots 1, 2, 3, 5, 6, 7 and 69 bits in slots 0 and 4.

If the field **Ignore 1/4 symbol (slot length 156 symbols)** (page 4.277) is enabled, all slots are 156 symbols long. The extra  $\frac{1}{4}$  symbol is omitted. The extended guard field for the burst always has the same length regardless of the slot index. A frame is therefore 1248 symbols long in place of 1250.

Remote-control command: n.a.

**Slot Marker Definition - GSM/EDGE**

Calls the menu for defining the marker signal at slot level. This menu is described below in the section "[Slot Marker Definition - GSM/EDGE](#)".

Remote-control command: n.a.

## Slot Marker Definition - GSM/EDGE

To call the **Control List Editor** for defining the marker signal at slot level, use the **Slot Marker Definition** button in the burst editor of the GSM/EDGE menu.

A rectangular button with a blue border and a dotted background, containing the text "Slot Marker Definition...".

---

**Note:**

*The marker signals thus defined will only become effective if the "As defined in slot" marker type in the **Trigger/Marker/Clock menu** is selected.*

---

The structure of the selected slot (in the example, synchronization burst) is displayed in the menu header. The individual fields of the burst are colour-coded.

The available marker signals are also colour-coded. In the left **Configure Control Signal** section, each individual signal is assigned a colour; a check in the check box shows the marker for which the "**As defined in slot**" marker type has been selected.

In the next section, **Select Ramp to Edit**, the signal characteristics are graphically displayed. The ramps can be assigned the exact bit position in the signal by means of

- The schematic display of the slot above the section.
- The bit scale below the marker/control signal characteristic.
- The display of the current cursor position in the **Cursor** menu section if the cursor marks the ramp. The field at the selected position in the slot is displayed on the side. The bit position of the cursor within this field is displayed below

The ramps can be set either graphically in the **Select Ramp to Edit** section or in the table of the **Positions Marker x** section. To make the setting easy, a selection of preset ramp characteristics is offered in the **Preset Ramp Marker x** section.

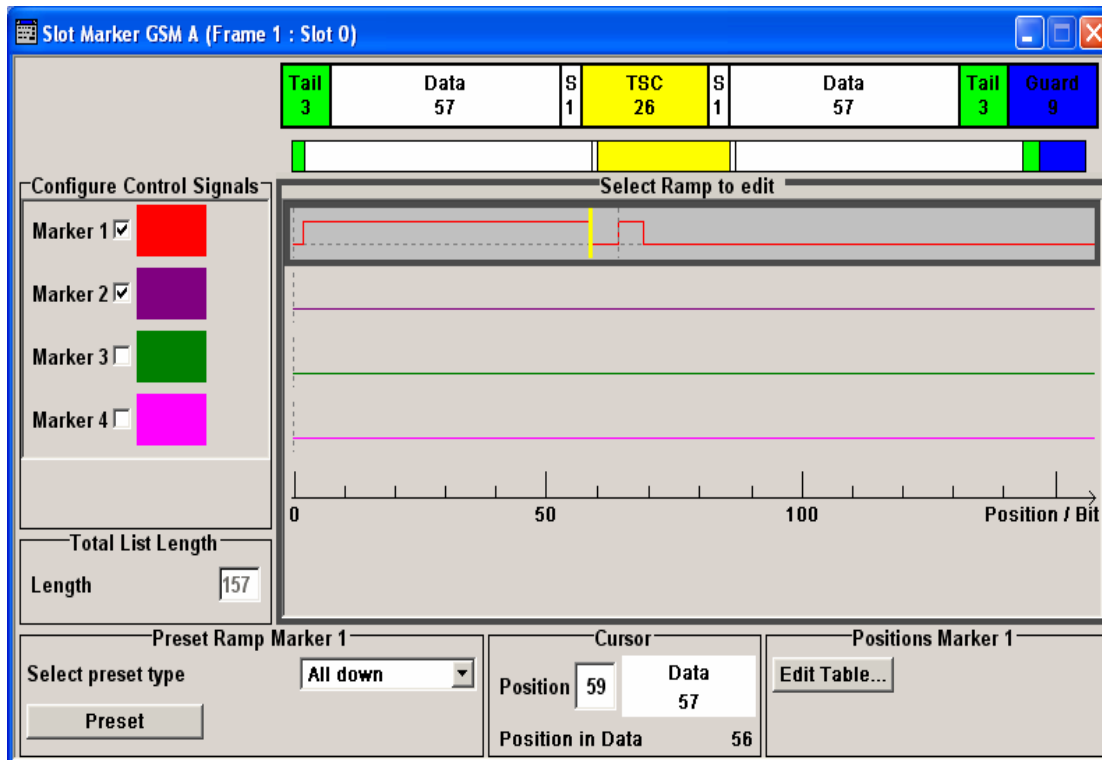

### Configure Control Signal - GSM/EDGE

Displays the colour the marker has been assigned.

Displays whether the "CList" marker type has been selected in the Trigger/Marker/Clock menu for this marker.

Displays whether the "As defined in Slot" source has been selected for this marker signal in the individual setting menu.

The source can be selected here as well and will then be used in the associated menus.

---

#### **Note:**

*The burst gate signal is only displayed and cannot be edited.*

---

Chapter 3 describes in detail how to use the control and marker list editor.

Remote-control command:

```
SOUR:BB:GSM:TRIG:OUTP1:MODE SDEF
```

**Select Ramp to Edit -  
GSM/EDGE**

Graphically edit marker signals.

For this purpose, the cursor is set to the position where a ramp is required. The ramp is generated by pressing Enter (e.g. clicking on the rotary knob). Any number of ramps can be defined per marker. Each of the generated ramp positions will be saved even if the definition of another ramp produces a low/low or high/high transition. The ramps are displayed as dashed lines.

Existing ramps can be shifted after the cursor has been placed on the ramp and Enter has been pressed – it then changes colour twice. The ramp is shifted by using the cursor keys or the rotary knob. The new position is determined by pressing Enter again.

Ramps can be deleted by means of the **BACK-SPACE** key after the cursor has been placed on the ramp.

"Chapter 3" describes in detail how to use the control and marker list editor.

Remote-control command: n.a.

**Preset Ramp - GSM/EDGE**

Activates presetting for the ramp characteristic of the selected control signal. The presetting is selected with **Select Preset Type** and activated by means of the **Preset** button.

You can select from:

**All Up**                    The marker signal is continuously high.

**All Down**                The marker signal is continuously low.

**Ramp Up**                 The marker signal contains a ramp from low to high. The ramp is shifted to the center of the displayed signal area and can subsequently be shifted as required.

**Ramp Down**             The marker signal contains a ramp from high to low. The ramp is shifted to the center of the displayed signal area and can subsequently be shifted as required.

**Ramp Up/Down**        The marker signal contains a ramp from low to high and from high to low. The ramps are symmetrically shifted around the center of the displayed signal area and can subsequently be shifted as required.

**Ramp Down/Up** The marker signal contains a ramp from high to low and from low to high. The ramps are symmetrically shifted around the center of the displayed signal area and can subsequently be shifted as required.

### Cursor Position - GSM/EDGE

Enters the cursor position.

In the graphic display, the cursor is positioned according to the entry.

Vice versa, graphically shifting the cursor will change the displayed value.

The field at the selected position in the slot is displayed on the side. The bit position of the cursor within this field is displayed below.

"Chapter 3" describes in detail how to use the control and marker list editor.

Remote-control command: n.a.

### Ramp Positions - GSM/EDGE

Opens table by using the **Edit Table...** button.

The ramps of the selected signal can be edited in the table. When the table is opened, the current configuration of the selected marker/control signal is displayed.

	Ramp Positions	Ramp State
1	4	High
2	20	Low
3	29	High
4	34	Low
5	52	High
6	100	Low
7	104	Low
8		

Accept

The bit position is specified in the **Ramp Position** column, the high or low signal status in the **Ramp State** column. At the end of the list, there is always a blank row for entering new values.

The changes are accepted in the graphic display after pressing the **Accept** button.

"Chapter 3" describes in detail how to use the control and marker list editor.

Remote-control command: n.a.





# Digital Standard 3GPP FDD

## Introduction - Digital Standard 3GPP FDD

The R&S Vector Signal Generator provides you with the ability to generate signals in accordance with the WCDMA standard 3GPP FDD.

The equipment layout for 3GPP FDD signal generation includes the options Baseband Main Module (B13), Baseband Generator (B10/B11) and Digital Standard 3GPP FDD (K42). B10 features a much larger ARB memory size than B11 (see data sheet). But apart from the memory size, both options have the same functionality and are installed alternatively.

Option 3GPP FDD enhanced MS/BS tests incl. HSDPA (K43) extends the 3GPP FDD signal generation with simulation of high speed channels in the downlink (HS-SCCH, (HS-SCCH, HS-PDSCH) and the uplink (HS-DPCCH) and with dynamic power control in real time. HSDPA (high speed downlink packet access) mode enhances the 3GPP FDD standard by data channels with high data rates especially for multi media applications. Option 3GPP FDD enhanced BS/MS test including HSUPA (K45) extends the 3GPP FDD signal generation with full HSUPA (high speed uplink packet access) support.

In the case of two-path instruments, at least one more option, the Baseband Generator (B10/B11) is required to generate a 3GPP FDD signal in the second path. With this option, a 3GPP FDD signal can be defined on path B and then either be routed to path A or added to the path A signal with a settable frequency offset. Generating the 3GPP FDD signal simultaneously on paths A and B requires an additional, second option, the (Digital Standard 3GPP FDD (K42). With a full path B configuration with a second option (Baseband Main Module (B13) and an RF section (frequency option B20x), the 3GPP FDD signal can be output at RF output B.

WCDMA (Wideband CDMA) describes a group of mobile radio communication technologies, the details of which differ greatly. The R&S Vector Signal Generator supports the 3GPP FDD standard developed by the 3GPP ("3<sup>rd</sup> Generation Partnership Project") standardization committee. The standard is implemented in accordance with Release 5, dated January 2003. The signals can also be set to be compatible with Releases 3 and 4, by not using the new functions of later releases (e.g. no HSDPA channels). Details can be found in the relevant releases of the standard.

The R&S Vector Signal Generator generates the 3GPP FDD signals in a combination of realtime mode (enhanced channels) and arbitrary waveform mode. Channel coding and simulation of bit and block errors can be activated for the enhanced channels generated in realtime. Data lists can also be used for the data and TPC fields. The enhanced state of realtime channels (4 channels of base station 1 and all channels of user equipment 1) can be switched off to generate specific test scenarios. In arbitrary waveform mode, the signal is first calculated and then output.

The R&S Vector Signal Generator simulates 3GPP FDD at the physical channel level and - for enhanced channels - also at the transport layer level. The following list gives an overview of the options provided by the R&S Vector Signal Generator for generating a 3GPP FDD signal:

- Configuration of up to 4 base stations and 4 user equipment.
- Combination of realtime mode (enhanced channels) and arbitrary waveform mode.
- All special channels and up to 512 channels on the downlink
- Various test models and pre-defined settings for the uplink and the downlink
- Modulation 16 QAM (downlink) for configuring high-speed channels (test model 5, HSDPA)
- Clipping for reducing the crest factor
- "Misuse TPC" parameter for varying the original normal transmit power over time
- Simulation of up to 64 additional user equipment

**The following functions are provided specifically for the receiver test:**

- Realtime generation of up to 4 code channels with the option of using data lists for the data and TPC fields
- Channel coding of the reference measurement channels, AMR and BCH in realtime
- Feeding through of bit errors (to test a BER tester) and block errors (to test a BLER tester)
- Simulation of orthogonal channel noise (OCNS in accordance with TS 25.101)
- External control of channel performance in realtime
- Closed loop transmit diversity
- Presettings in accordance with 3GPP specifications

**The following functions are provided by extension K43 Enhanced BS/MS Tests Including HSDPA:**

- HSDPA Uplink
- HSDPA Downlink (packet mode and H-Set mode)
- HSDPA Downlink in continuous mode (test model 5 for TX tests)
- Dynamic Power Control

**The following functions are provided by extension K45 Enhanced BS/MS test including HSUPA:**

- HSUPA Downlink (RX measurements on 3GPP FDD UEs with correct timing )
- HSUPA Uplink (RX measurements on 3GPP FDD Node BS supporting HSUPA)

Table 4-11 Parameters of the modulation system 3GPP FDD

Parameter	Value
Chip rate	3.84 Mcps
Channel types	<p>Downlink :</p> <ul style="list-style-type: none"> <li>• Primary Common Pilot Channel (P-CPICH)</li> <li>• Secondary Common Pilot Channel (S-CPICH)</li> <li>• Primary Sync Channel (P-SCH)</li> <li>• Secondary Sync Channel (S-SCH)</li> <li>• Primary Common Control Phys. Channel (P-CCPCH)</li> <li>• Secondary Common Control Phys. Channel (S-CCPCH)</li> <li>• Page Indication Channel (PICH)</li> <li>• Access Preamble Acquisition Indication Channel (AP-AICH)</li> <li>• Collision Detection Acquisition Indication Channel (CD-AICH)</li> <li>• Phys. Downlink Shared Channel (PDSCH)</li> <li>• Dedicated Physical Control Channel (DL-DPCCH)</li> <li>• Dedicated Phys. Channel (DPCH)</li> <li>• High Speed Shared Control Channel (HS-SCCH)</li> <li>• High Speed Physical Downlink Shared Channel (HS-PDSCH), Modulation QPSK or 16 QAM</li> <li>• HSUPA channels (E-AGCH, E-RGCH, E-HICH, F-DPCH)</li> </ul> <p>Uplink :</p> <ul style="list-style-type: none"> <li>• Phys. Random Access Channel (PRACH)</li> <li>• Phys. Common Packet Channel (PCPCH)</li> <li>• Dedicated Physical Control Channel (DPCCH)</li> <li>• Dedicated Physical Data Channel (DPDCH)</li> <li>• E-DCH Dedicated Physical Control Channel (E-DPCCH)</li> <li>• E-DCH dedicated physical data channel (E-DPDCH)</li> </ul>
Symbol rates	7.5 ksps, 15 ksps, 30 ksps to 960 ksps depending on the channel type (downlink) 15 ksps, 30 ksps, 60 ksps to 6 x 960 ksps overall symbol rate on uplink
Channel count	In downlink 4 base stations each with up to 128 DPCHs and 11 special channels. In uplink 4 user equipment either with PRACH or PCPCH or DPDCH and up to 6 DPDCHs.
Frame structure	Timeslot: 0.667 ms, Radio frame: 15 timeslots = 10 ms,  The frame structure of symbols depends on the symbol rate.
Scrambling code	Downlink: 18 bit M sequence Uplink: 25 bit M sequence in long mode and 8 bit M sequence in short mode
Channelization code for DPCH, DPDCH and DPCCH	"Orthogonal Variable Spreading Factor Code (OVSF)" square matrix of dimension <i>chip rate/symbol rate</i>

# Modulation System 3GPP FDD

The following block diagram shows the components of the 3GPP FDD transmission system.

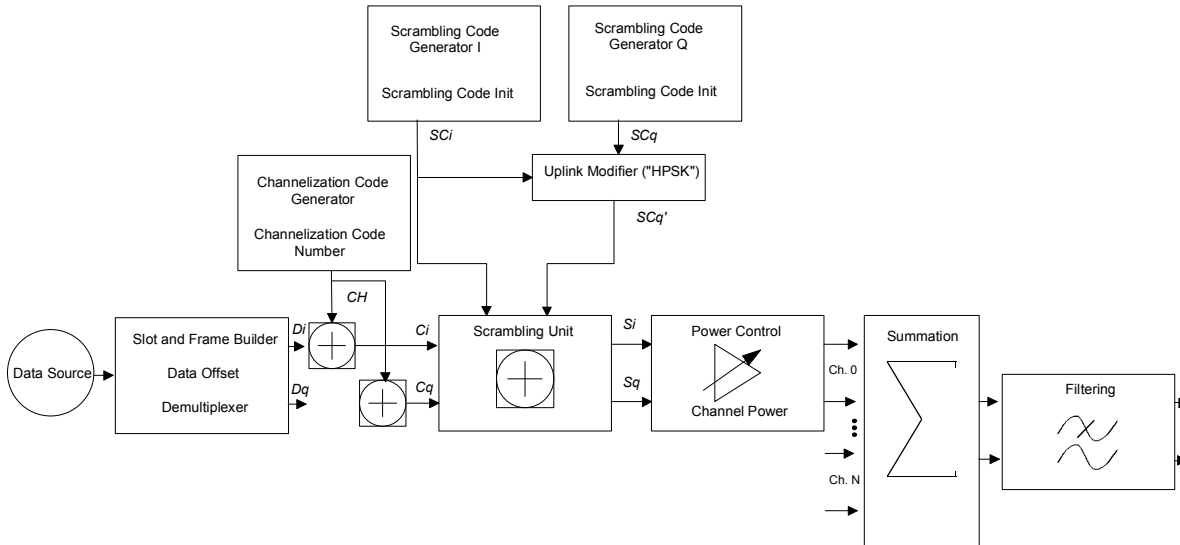

Fig. 4-16 Components of the 3GPP FDD transmission system

## Scrambling Code Generator - 3GPP FDD

The scrambling code generator (previously called long code generator) is used to scramble the chip sequence as a function of the transmitter.

Depending on the link direction and mode (long or short), the structure and initialization regulation of the generator are different.

### Downlink Scrambling Code Generator

This generator consists of a pair of shift registers from which the binary sequences for inphase and orthogonal component of the scrambling code are determined. Figure "Structure of downlink scrambling code generator" (see below) shows that the I component is produced as EXOR operation of the LSB outputs, whereas the register contents are first masked and read out for the Q component and then EXORed.

Table 4-12 Generator polynomials of the downlink scrambling code generators

Shift register 1	$x^{18}+x^7+1$
Shift register 2	$x^{18}+x^{10}+x^7+x^5+1$

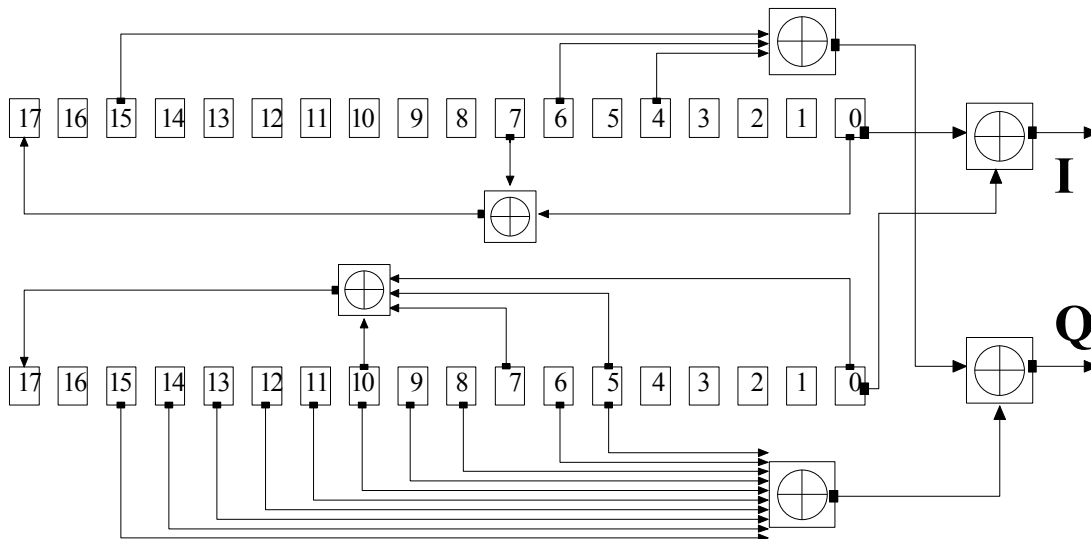

Fig. 4-17 Structure of downlink scrambling code generator

The shift registers are initialized by loading shift register 1 with “0...01” and shift register 2 completely with “1”. In addition, shift register 1 is wound forward by n cycles, n being the scrambling code number or Scrambling Code (SC) for short.

After a cycle time of one radio frame the generators are reset, i.e. the above initialization is carried out again.

**Uplink Scrambling Code Generator**

In the uplink, a differentiation is made between two SC modes. The long SC, on the one hand, can be used for all types of channel. The short SC, on the other hand, can be used as an alternative to the long SC for all channels except PRACH and PCPCH.

**Uplink long scrambling code**

Principally, the code generator of the long SC in the uplink is of the same structure as the SC in the downlink. However, the generator polynomials of the shift registers and the type of initialization are different.

Table 4-13 Generator polynomials of the uplink long scrambling code generator

Shift register 1	$x^{25}+x^3+1$
Shift register 2	$x^{25}+x^3+x^2+x+1$

The shift registers are initialized by allocating 1 to shift register 1 bit number 24 and the binary form of the scrambling code number n to bits 23 to 0. Shift register 2 is completely loaded with “1”.

The read-out positions for the Q component are defined such that they correspond to an IQ offset of 16.777.232 cycles.

After a cycle time of one radio frame the generators are reset, i.e. the above initialization is carried out again.

**Uplink short scrambling code**

The code generator of the short SC in the uplink consists of a total of 3 coupled shift registers.

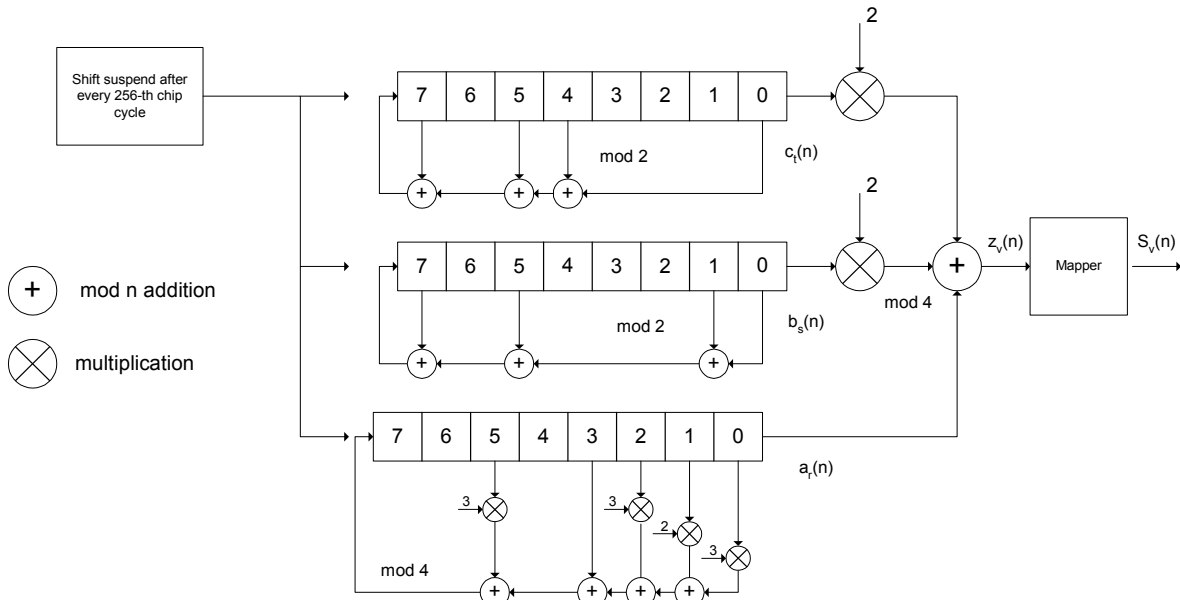

Fig. 4-18 Structure of uplink short scrambling code generator

Table 4-14 Generator polynomials of uplink short scrambling code generator

Shift register 1 (binary)	$x^8+x^7+x^5+x^4+1$
Shift register 2 (binary)	$x^8+x^7+x^5+x+1$
Shift register 3 (quaternary)	$x^8+x^5+3x^3+x^2+2x1$

The output sequences of the two binary shift registers are weighted with factor 2 and added to the output sequence of the quaternary shift register (Modulo 4 addition). The resulting quaternary output sequence is mapped into the binary complex level by the mapper block.

For initialization of the three 8-bit shift registers (in a modified way) the binary form of the 24-bit short SC number n is used, for details see 3GPP TS 25 213, Spreading and Modulation.

Table 4-15 Mapping of the quaternary output sequence into the binary IQ level

zv(n)	Sv(n)
0	+1 + j1
1	-1 + j1
2	-1 - j1
3	+1 - j1

**Preamble scrambling code generator**

When generating the preambles of the PRACH and PCPCH a special SC is used. It is based on the Long SC described under a), however only the I component is taken and subsequently a pointer ( $e^{j(\pi/4 + \pi/4 * k)}$ , k=0 to 4095) modulated upon it.

### Modification of the long and short scrambling code output sequence

The scrambling code sequence of the Q component is modified as standard to reduce the crest factor of the signal. Zero-crossings can thus be avoided for every second cycle. (This method is often called "HPSK").

For details see 3GPP TS 25 213, Spreading and Modulation. R&S Vector Signal Generator makes use of a decimation factor of 2.

## Scrambling Unit - 3GPP FDD

In the scrambling unit, the output of the scrambling code generator is linked with spread symbols. If the input signal and the scrambling code signal are interpreted as complex signal ( $C_i, C_q, SC_i, SC_q' \in \{-1, +1\}$ ), the output signal is a complex multiplication of the two signals:

$$S_i + j S_q = (C_i + j C_q) * (SC_i + j SC_q')$$

and the following equations apply

$$S_i = C_i SC_i - C_q SC_q'$$

$$S_q = C_i SC_q' + C_q SC_i$$

The signal thus obtained can be interpreted as a QPSK signal with the following constellation diagram:

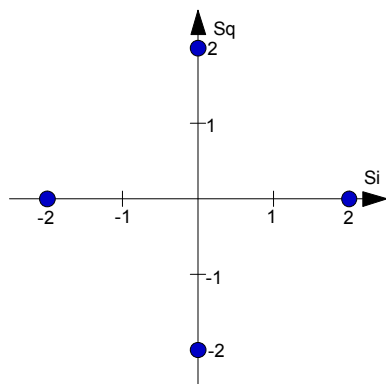

Fig. 4-19 Constellation diagram of a channel with 0 dB power

---

#### Note:

*There are auxiliary conditions for some types of channels that may result in different constellation diagrams. If, for instance, symbols of the SCH are coded, a BPSK constellation is obtained without the scrambling unit.*

---

## Channelization Code Generator - 3GPP FDD

The channelization code generator cyclically outputs a channel-specific bit pattern. The length of the cycle corresponds to the period of the source symbol to be spread, i.e. the number of bits corresponds to the spread factor. The spreading sequence for the I and Q branch is identical (real value). Spreading is a simple EXOR operation.

Two different channelization code generators are used depending on the type of channel:

### Channelization code generator for all channels except SCH

Due to this channelization code the channel separation takes place in the sum signal. The channelization code number is the line of an orthogonal spreading matrix which is generated according to an iterative scheme ("OVSF").

### Channelization code generator SCH

This generator replaces the one described above if the synchronization code symbol of the SCH channels is spread.

The spreading matrix is replaced by a method that forms the spreading sequence from a Hadamard sequence and a statistical sequence. For details see 3GPP TS 25 213.

## Data Source - 3GPP FDD

The data source used in arbitrary waveform mode is implemented at the physical layer. There is neither mapping of logical channels to physical channels nor is inner coding/outer coding performed.

The data and TPC fields of the enhanced channels (realtime channels) can be filled from data lists containing data defined by the user. This allows user information from higher levels such as the transport or physical layers to be introduced into the signal generation process.

The choice of data sources is crucially important for the signal characteristics. The constellation diagram and the crest factor in particular are modeled to a great extent by a suitable choice of data (see WinIQSIM manual, chapter 8).

## Slot and Frame Builder - 3GPP FDD

The bits from the data source are first entered into a frame structure. The frames are made up of two hierarchical levels:

Table 4-16 Hierarchical structure of 3GPP FDD frames

Hierarchy	Length in ms	Remarks
Timeslot	0,667	
Radio frame	10	After a radio frame, pilot symbols are repeated. One radio frame consists of 15 timeslots. A frame is also the length of a scrambling code cycle. Frames are the basic unit in R&S Vector Signal Generator. The sequence length is stated in radio frames.



The configuration of the timeslots depends on the channel type and symbol rate. The following components are distinguished:

- **Pilot sequence**  
The pilot sequence characterizes the timeslot position within the radio frame and also depends on the symbol rate, transmit diversity and the pilot length parameter.  
Channel types DPCH, S-CCPCH, DL-DPCCH, DPCCH, PRACH and PCPCH have a pilot sequence.  
The pilot sequence cannot be changed by the user.
- **Synchronization code symbol**  
The synchronization code symbol is the only symbol of the SCH. It is fixed to "11".
- **TPC symbol**  
This symbol is used to control the transmit power. It is used in DPCH, DL-DPCCH and DPCCH. A bit pattern for the sequence of TPC symbols can be indicated as a channel-specific pattern.
- **Data symbols**  
These symbols carry the user information and are fed from the data source. They are used in DPCH, P-CCPCH, S-CCPCH, PDSCH, DL-DPCCH, DPDCH, PRACH and PCPCH.
- **Signature**  
The signature is used in PRACH and PCPCH. 16 fixed bit patterns are defined of which the user may select one.
- **TFCI**  
The "Transport Format Combination Indicator" is used in DPCH/DPCCH if the state is set to On. In this case, a code sequence with the length of 30 is defined using this value and distributed among 15 subsequent timeslots. In PRACH and PCPCH, the TFCI field is provided as standard.
- **FBI**  
Feedback indication bits are only used in DPCCH and PCPCH.

## Timing Offset - 3GPP FDD

The symbol stream can be shifted in time relative to the other channels. For this purpose a timing offset can be entered into the channel table, stating the range of shifting in multiples of 256 chips. Since the generator does not generate infinite symbol streams like a real-time system, this offset is implemented as a rotation.

**Example** for DPCH 30 ksps, 1 timeslot, timing offset = 2;

2 x 256 chips = 512 chip offset;

4 data symbols shifting at a symbol rate of 30 ksps (1 symbol corresponds to  $3.84 \text{ Mcps} / 30 \text{ ksps} = 128 \text{ chips}$ ).

previously:

11	11	11	11	00	01	10	11	00	10	01	11	11	01	00	01	10	11	01	00
----	----	----	----	----	----	----	----	----	----	----	----	----	----	----	----	----	----	----	----

afterwards:

10	11	01	00	11	11	11	11	00	01	10	11	00	10	01	11	11	01	00	01
----	----	----	----	----	----	----	----	----	----	----	----	----	----	----	----	----	----	----	----

The use of the timing offset usually causes a reduction of the crest factor of the total signal, since it is not always the same spreading chips (channelization chips)  $CH$  and scramble chips  $SC/SC_q'$  that are applied to the pilot sequences of the channels.

## Demultiplexer - 3GPP FDD

In the downlink, the symbol stream is divided into two bit streams  $D_i$  and  $D_q$  prior to processing in the spreading unit. The symbol stream is divided by allocating bits 1, 3, 5, to  $2n-1$  to the in-phase bit stream  $D_i$ , and bits 2, 4, 6,  $2n$  to the quadrature bit stream  $D_q$ .

For the above example with timing offset:

$$D_i = 11001111001101011000$$

$$D_q = 01101111010100111101$$

(left-hand bit is always the first one in the time sequence)

In the uplink, independent data are used for the two paths.

PRACH/PCPCH: Preamble : signature parallel to I and Q

Message part : data to I, pilot, TPC and TFCI to Q

DPCCH: all bits to I, Q always unused

DPDCH: all bits are always to I or Q (dependent on channel number), the other path is unused.

## Power Control - 3GPP FDD

After spreading and scrambling, a channel-specific power factor  $p$  is applied to the signal. A value of -6 dB therefore results in half the level (or  $\frac{1}{4}$  power) and the following diagram (DPCH):

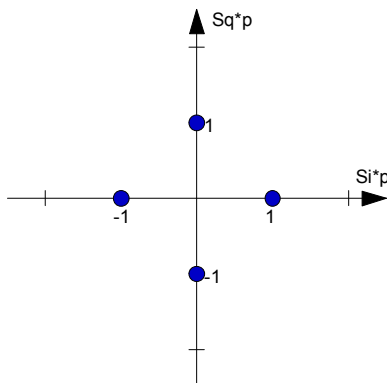

Fig. 4-20 Constellation diagram of a channel with -6 dB power

## Summation and Filtering - 3GPP FDD

After application of the channel power, the components of the individual channels are summed up.

The constellation diagram of the sum signal is obtained by superposition of the diagrams of the individual channels. If the signal consists of two channels with a power of -6 dB and -12 dB and each channel contains independent source data (DPCH), the following constellation diagram is obtained:

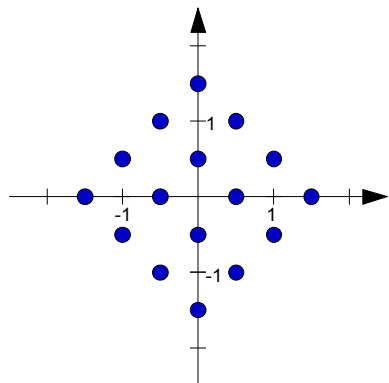

Fig. 4-21 Constellation diagram of a 3GPP W-CDMA signal with two DPCH channels

An unfiltered spread signal is obtained after summation. Due to filtering the number of samples is increased by the oversampling factor and band-limiting is performed.

## Multicode - 3GPP FDD

3GPP FDD supports multicode transmission for downlink-dedicated physical channels (DPCH).

This form of transmission is used for channels intended for the same receiver, i.e. those receivers that belong to a radio link. The first channel of this group is used as a master channel.

Shared parts (pilot, TPC and TCFI) are spread for all channels using the spreading code of the master channel.

---

**Note:**

*Instead of changing the spreading code within a slot several times, the master code rather than the shared parts can be sent at higher power. The other channels then have to be blanked out correspondingly.*

---

# 3GPP FDD Menu

The menu for setting the 3GPP FDD digital standard is either called from the baseband block or from the menu tree under Baseband.

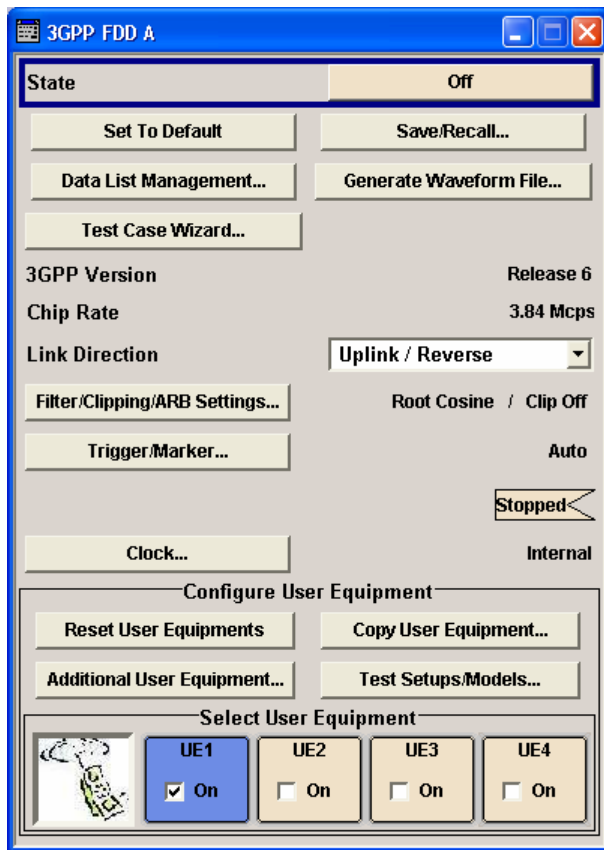
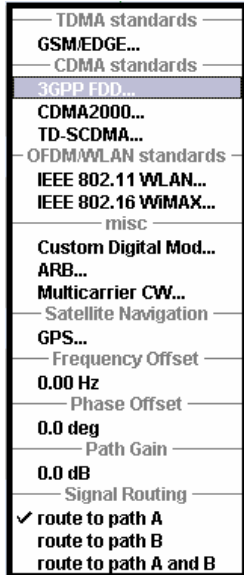

The menu is split into several sections for configuring the standard. The choice of transmission direction determines which displays and parameters are made available in the lower section.

The upper section of the menu is where the 3GPP FDD digital standard is enabled, the default settings are called and the transmission direction selected. Button **Test Case Wizard** opens a configuration menu with a selection of predefined settings according to Test Cases in TS 25.141. The valid 3GPP version and the chip rate in use are displayed. Many of the buttons lead to submenus for loading and saving the 3GPP FDD configuration and for setting the filter, trigger and clock parameters.

The lower menu section is where either the base station signal or the user equipment signal is configured, depending on the transmission direction selected.

## General Settings for 3GPP FDD Signals

The upper menu section is where the 3GPP FDD digital standard is enabled and reset and where all the settings valid for the signal in both transmission directions are made.

### State - 3GPP FDD

Enables/disables the 3GPP FDD standard.

Enabling this standard disables all the other digital standards and digital modulation modes on the same path.

The 3GPP FDD signal is generated by a combination of realtime mode (enhanced channels) and arbitrary waveform mode (all the other channels).

On the downlink, P-CCPCH and up to three DPCHs of base station 1 are generated in realtime. All the other channels are generated in arbitrary waveform mode and added.

In the uplink, all the channels of user equipment 1 are generated in realtime (PRACH, PCPCH or DPCCH and up to 6 DPCHs), the other user equipment are generated in arbitrary waveform mode and added to the realtime signal.

Remote-control command:

```
SOUR:BB:W3GP:STAT ON
```

### Set to default - 3GPP FDD

Calls the default settings. Test Model 1 (64 channels) is preset.

Remote-control command:

```
SOUR:BB:W3GP:PRES
```

### Save/Recall - 3GPP FDD

Calls the **Save/Recall** menu.

From the **Save/Recall** menu the **File Select** windows for saving and recalling 3GPP FDD configurations and the **File Manager** can be called.



3GPP FDD configurations are stored as files with the predefined file extension **\*.3g**. The file name and the directory they are stored in are user-definable.

The complete settings in the **3GPP FDD** menu are saved and recalled.

**Recall 3GPP FDD setting** Opens the **File Select** window for loading a saved 3GPP FDD configuration.

The configuration of the selected (highlighted) file is loaded by pressing the **Select** button.

Remote-control command:

```
MMEM:CDIR 'F:\gen_lists\3gpp'
```

```
SOUR:BB:W3GP:SETT:CAT?
```

```
Response: '3g_1',3g_2'
```

```
SOUR:BB:W3GP:SETT:LOAD "3g_1"
```

**Save 3GPP FDD setting** Opens the **File Select** window for saving the current 3GPP FDD signal configuration.

The name of the file is specified in the **File name** entry field, the directory selected in the **save into** field. The file is saved by pressing the **Save** button.

Remote-control command:

```
MMEM:CDIR 'F:\gen_lists\3gpp'
```

```
SOUR:BB:W3GP:SETT:STOR '3g_3'
```

**File Manager** Calls the **File Manager**.

The **File Manager** is used to copy, delete and rename files and to create new directories.

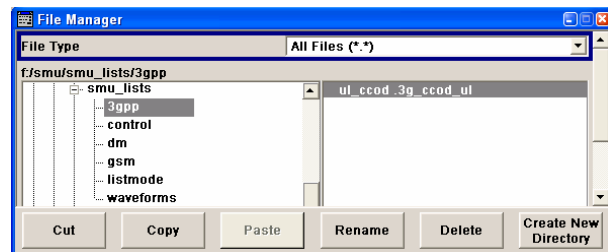

Remote-control commands::

```
MMEM:CDIR 'F:\gen_lists\3gpp'
```

```
SOUR:BB:W3GP:SETT:DEL '3g_1'
```

**Data List Management -  
3GPP FDD**

Calls the **Data List Management** menu. This menu is used to create and edit a data list.

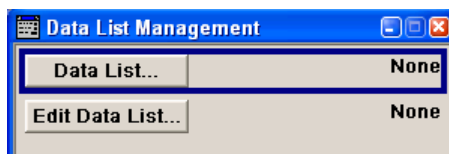

All data lists are stored as files with the predefined file extension **\*.dm\_iqd**. The file name and the directory they are stored in are user-definable.

The data lists must be selected as a data source from the submenus under the individual function, e.g. in the channel table of the base stations.

Remote-control commands:

**Note:**

*All data lists are generated and edited by means of the **SOURce:BB:DM** subsystem commands. Files containing data lists usually end with **\*.dm\_iqd**. The data lists are selected as a data source for a specific function in the individual subsystems of the digital standard.*

**Creating and editing the data list:**

```
SOUR:BB:DM:DLIS:SEL "3gpp"
SOUR:BB:DM:DLIS:DATA 1,1,0,1,0,1,0,1,1,1,1,0,0,0
SOUR:BB:DM:DLIS:DATA:APP 1,1,0,1,0,1,0,1,1,1,1,0,0
```

**Selecting the data list:**

```
SOUR:BB:W3GP:BST2:CHAN13:DATA DLIS
SOUR:BB:W3GP:BST2:CHAN13:DATA:DSEL "d_bst1"

SOUR:BB:W3GP:BST2:CHAN13:DPCC:TPC:DATA DLIS
SOUR:BB:W3GP:BST2:CHAN13:DPCC:TPC:DATA:DSEL 'tpc1'

SOUR:BB:W3GP:BST:ENH:CHAN13:DPCH:TCH:DATA DLIS
SOUR:BB:W3GP:BST:ENH:CHAN13:DPCH:TCH:DATA:DSEL 'd1'

SOUR:BB:W3GP:MST2:CHAN:DPDC:DATA DLIS
SOUR:BB:W3GP:MST2:CHAN:DPDC:DATA:DSEL "d_up1"

SOUR:BB:W3GP:MST:CHAN:DPDC:DATA:DCCH DLIS
SOUR:BB:W3GP:MST:CHAN:DPDC:DATA:DCCH:DSEL "d_up1"

SOUR:BB:W3GP:MST:ENH:DPDC:TCH:DATA DLIS
SOUR:BB:W3GP:MST:ENH:DPDC:TCH:DATA:DSEL "d_up2"

SOUR:BB:W3GP:MST2:DPCC:TPC:DATA DLIS
SOUR:BB:W3GP:MST2:DPCC:TPC:DATA:DSEL "d_up4"

SOUR:BB:W3GP:MST2:PCPC:DATA DLIS
SOUR:BB:W3GP:MST2:PCPC:DATA:DSEL "d_up5"

SOUR:BB:W3GP:MST2:PCPC:TPC:DATA DLIS
SOUR:BB:W3GP:MST2:PCPC:TPC:DATA:DSEL "d_up6"

SOUR:BB:W3GP:MST2:PRAC:DATA DLIS
SOUR:BB:W3GP:MST2:PRAC:DATA:DSEL "d_up7"
```

**Generate Waveform File - 3GPP FDD**

Opens the submenu for storing the current 3GPP signal as ARB signal in a waveform file. This file can be loaded in the ARB menu and processed as multicarrier or multisegment signal.

The file name is entered in the submenu. The file is stored with the predefined file extension \*.wv. The file name and the directory it is stored in are user-definable.

Remote-control commands:

SOUR:BB:W3GP:WAV:CRE "c:\temp\w3gpp\_wv"

**Test Case Wizard - 3GPP FDD**

Opens a configuration menu with a selection of predefined settings according to Test Cases in TS 25.141.

The test cases are described in Section "[Tests on Base Stations in Conformance with the 3G Standard 3GPP-FDD](#)".

Remote-control command: n.a.

**3GPP Version - 3GPP FDD**

Displays the current version of the 3GPP FDD standard.

The default settings and parameters provided are oriented towards the specifications of the version displayed.

Remote-control command:

SOUR:BB:W3GP:GPP3:VERS?

Response: V6.0.0

**Chip Rate - 3GPP FDD**

Displays the system chip rate. This is fixed at 3.84 Mcps.

The output chip rate can be varied in the Filter menu, Clipping, ARB Settings (see Section "[Filtering, Clipping, ARB Settings - 3GPP FDD](#)", Page 4.337).

Remote-control command:

SOUR:BB:W3GP:CRAT?

Response: R3M84

**Link Direction - 3GPP FDD**

Selects the transmission direction.

The settings of the base station or the user equipment are provided in the following menu section in accordance with the selection.

**Downlink/  
Forward Link**

The transmission direction selected is base station to user equipment. The signal corresponds to that of a base station.

Remote-control command:

SOUR:BB:W3GP:LINK DOWN

**Uplink/  
Reverse Link**

The transmission direction selected is user equipment to base station. The signal corresponds to that of a user equipment.

Remote-control command:

SOUR:BB:W3GP:LINK UP



**Filtering, Clipping, ARB Settings - 3GPP FDD**

Calls the menu for setting baseband filtering, clipping and the sequence length of the arbitrary waveform component. The current setting is displayed next to the button.

The menu is described in Section "[Filtering, Clipping, ARB Settings - 3GPP FDD](#)", Page 4.337.

Remote-control command: n.a.

**Trigger - Marker - 3GPP FDD**

Calls the menu for selecting the trigger source, for configuring the marker signals and for setting the time delay of an external trigger signal (see Section "[Trigger/Marker/Clock - 3GPP FDD](#)", Page 4.332).

The currently selected trigger source is displayed to the right of the button.

Remote-control command: n.a.

**Execute Trigger - 3GPP FDD**

Executes trigger manually.

A manual trigger can be executed only when an internal trigger source and a trigger mode other than **Auto** have been selected.

Remote-control commands:

SOUR:BB:W3GP:TRIG:SOUR INT

SOUR:BB:W3GP:SEQ RETR

SOUR:BB:W3GP:TRIG:EXEC

**Clock - 3GPP FDD**

Calls the menu for selecting the clock source and for setting a delay (see Section "[Trigger/Marker/Clock - 3GPP FDD](#)", Page 4.332").

Remote-control command: n.a.

## Configure Base Station or UE - 3GPP FDD

Depending on the transmission direction selection, the central section of the menu provides either the **Configure Base Station** section (selection **Downlink/Forward Link** ) or the **Configure User Equipment** section (selection **Uplink/Reverse Link**).

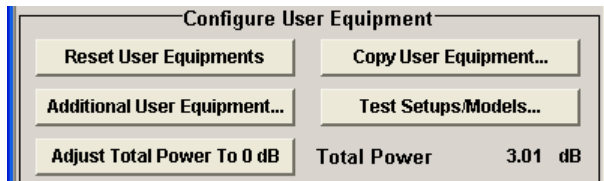
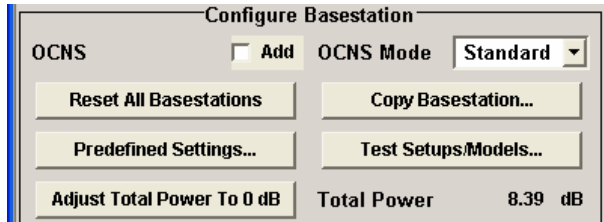

### Add OCNS - 3GPP FDD

Activates OCNS channels, as defined in the standard, in base station 1.

With Orthogonal Channel Noise, a practical downlink signal is generated to test the maximum input levels of user equipment in accordance with standard specifications. This simulates the useful and control signals of the other orthogonal channels in the downlink. 3GPP TS 25.101 contains a precise definition of the required appearance of the OCNS signal (see Tables).

Two different OCNS scenarios are defined in the standard; one standard scenario and one scenario for testing HSDPA channels. You can choose the scenario you want with **OCNS Mode**.

Remote-control command:

```
SOUR:BB:W3GP:BST:OCNS:STAT ON
```

**OCNS Mode - 3GPP FDD**

Chooses the scenario for activating OCNS channels.

Two different OCNS scenarios are defined in the standard; one **standard** scenario and one scenario for testing **HSDPA** channels.

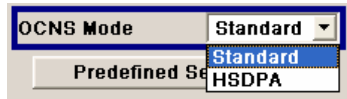

The scenarios have different channel counts and different presetting. The presetting is listed in the two tables below. It applies to both modes that the OCNS channels are all normal DPCHs. The symbol rate is set at 30 kps and the pilot length to 8 bits.

When activating OCNS, channels 18 - 33 (**Standard**) or 18 - 23 (**HSDPA**) are assigned as in the following tables. These channels cannot be edited in the channel table.

The powers of the OCNS channel outputs are relative. In the R&S Vector Signal Generator, the power of the OCNS component is automatically set so that OCNS channels supplement the remaining channels in base station 1 to make a total power of 0 dB (linear 1).

It is not possible to adapt the OCNS power; as the linear power of the remaining channels is >1, this will produce an error message. The OCNS channels are then given the maximum power (all -80 dB).

The **Total Power** display is updated after automatic calculation of the output; it is not possible to use **Adjust Total Power** to make the setting.

For **HSDPA** mode, the standard prescribes that the DPCH data of the individual channels must not be correlated. To meet this condition, the timing offset is chosen to give maximum displacement between the channels.

Remote-control command:

```
SOUR:BB:W3GP:BST:OCNS:MODE STAN | HSDP
```

Table 4-17 Defined settings for the OCNS signal in base station 1 in **Standard** mode

Channel number	Channelization code	Timing offset (x256Tchip)	Level setting (dB)	Channel type	Symbol rate	Pilot length
18	2	86	-1	DPCH	30 ksps	8 bit
19	11	134	-3	DPCH	30 ksps	8 bit
20	17	52	-3	DPCH	30 ksps	8 bit
21	23	45	-5	DPCH	30 ksps	8 bit
22	31	143	-2	DPCH	30 ksps	8 bit
23	38	112	-4	DPCH	30 ksps	8 bit
24	47	59	-8	DPCH	30 ksps	8 bit
25	55	23	-7	DPCH	30 ksps	8 bit
26	62	1	-4	DPCH	30 ksps	8 bit
27	69	88	-6	DPCH	30 ksps	8 bit
28	78	30	-5	DPCH	30 ksps	8 bit
29	85	18	-9	DPCH	30 ksps	8 bit
30	94	30	-10	DPCH	30 ksps	8 bit
31	125	61	-8	DPCH	30 ksps	8 bit
32	113	128	-6	DPCH	30 ksps	8 bit
33	119	143	0	DPCH	30 ksps	8 bit

Table 4-18 Defined settings for the OCNS signal in base station 1 in **HSDPA** mode

Channel number	Channelization code at SF=128	Relative Level setting (dB)	Channel type	Symbol rate	Pilot length
18	122	0	DPCH	30 ksps	8 bit
19	123	-2	DPCH	30 ksps	8 bit
20	124	-2	DPCH	30 ksps	8 bit
21	125	-4	DPCH	30 ksps	8 bit
22	126	-1	DPCH	30 ksps	8 bit
23	127	-3	DPCH	30 ksps	8 bit

**Reset all Base Stations - 3GPP FDD**

Resets all base stations to the predefined settings. The following table gives an overview of the settings. The preset value for each parameter is specified in the description of the remote-control commands.

Remote-control commands:  
 SOUR:BB:W3GP:BST:PRES

Parameter	Value
Base Station Configuration	
State	Off
State (all channels)	Off
Scrambling Code	0
Slot Format DPCH	8
Symbol Rate DPCH	30 ksps
Channelization Code (all channels)	0
Data Source (all channels)	PN9
Timing Offset (all channels)	0
Multi Code State (all channels)	Off

**Reset User Equipment - 3GPP FDD**

Resets all user equipment to the predefined settings. The following table gives an overview of the settings. The preset value for each parameter is specified in the description of the remote-control commands.

Remote-control commands:  
 SOUR:BB:W3GP:MST:PRES

Parameter	Value
User Equipment Configuration	
State	Off
Mode	DPCCH + DPDCH
Scrambling Code (hex)	0
DPCCH Settings	
Power	0 dB
DPDCH Settings	
All DPDCH Active	On
Channel Power	0 dB
Overall Symbol Rate	30 ksps

**Copy Basestation or Copy User Equipment... - 3GPP FDD**

Copies the settings of a base or user equipment to a second base or user equipment. A window opens for creating the destination station.

Window for the **Downlink / Forward** transmission direction:

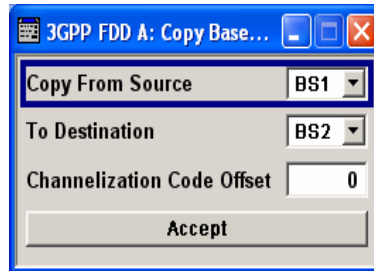

Window for the **Uplink / Reverse** transmission direction:

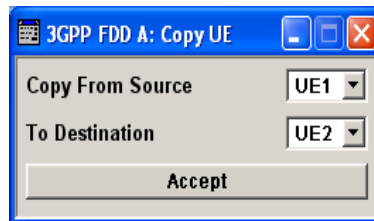

**Copy from Source** Selects the base station or user equipment whose settings are to be copied.

Remote-control command:

```
SOUR:BB:W3GP:LINK UP
SOUR:BB:W3GP:COPY:SOUR 1
```

**To Destination** Selects the base station or user equipment whose settings are to be overwritten.

Remote-control command:

```
SOUR:BB:W3GP:COPY:DEST 2
```

**Channelization Code Offset (Base Station only)** Enters the offset to be applied when copying the base station to the channelization codes of the destination base station. The minimum value is 0 (channelization codes are identical), the maximum value is 511.

Remote-control command:

```
SOUR:BB:W3GP:COPY:COFF 10
```

**Accept** Start the copy process.

Remote-control command:

```
SOUR:BB:W3GP:COPY:EXEC
```

<b>Test Setups, Models - 3GPP FDD</b>	<p>Calls menu for selecting one of the test models defined in the 3GPP standard and the self-defined test setups.</p> <p>The menu is described in Section "<a href="#">Test Setups - Models - 3GPP FDD</a>", Page 4.346.</p> <p>Remote-control command: n.a.</p>
<b>Predefined Settings Downlink - 3GPP FDD</b>	<p>Calls menu for setting predefined configurations.</p> <p>The menu is described in Section "<a href="#">Predefined Settings - Downlink - 3GPP FDD</a>", Page 4.349.</p> <p>Remote-control command: n.a.</p>
<b>Additional UE - 3GPP FDD</b>	<p><b>(Configure User Equipment only)</b></p> <p>Calls menu for simulating up to 64 additional user equipment.</p> <p>The menu is described in Section "<a href="#">Additional User Equipment - Uplink - 3GPP FDD</a>", Page 4.351.</p> <p>Remote-control command: n.a.</p>
<b>Adjust Total Power to 0dB - 3GPP FDD</b>	<p>Sets the power of an enabled channel so that the total power of all the active channels is 0 dB. This will not change the power ratio among the individual channels.</p> <p>Remote-control command: SOUR:BB:W3GP:POW:ADJ</p>
<b>Total Power - 3GPP FDD</b>	<p>Displays the total power of the active channels.</p> <p>The total power is calculated from the power ratio of the powered up code channels with modulation on. If the value is not equal to 0 dB, the individual code channels (whilst still retaining the power ratios) are internally adapted so that the <b>Total Power</b> for achieving the set output level is 0 dB.</p> <p>Remote-control command: SOUR:BB:W3GP:POW? Response: 0dB</p>
<b>Select Basestation or Configure User Equipment... - 3GPP FDD</b>	<p>Selects the base station or user equipment by pressing the accompanying button. This opens a menu for editing the selected basestation or user equipment.</p> <p>The menus are described in Sections "<a href="#">Base Station Configuration - 3GPP FDD</a>", Page 4.353 and "<a href="#">User Equipment Configuration (UE) - 3GPP FDD</a>", Page 4.413.</p> <p>Remote-control command: n.a. (the base station or user equipment is selected by the keyword index BStation&lt;[1] 2 3 4&gt; or. MStation&lt;i&gt; .)</p>

**Base Station or UE On - 3GPP FDD**

Activates or deactivates the base or user equipment.

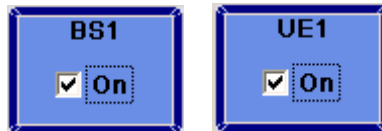

Remote-control command:

```
SOUR:BB:W3GP:BST1:STAT ON | OFF
SOUR:BB:W3GP:MST2:STAT ON | OFF
```

## Filtering, Clipping, ARB Settings - 3GPP FDD

The **Filtering, Clipping, ARB Settings** menu is reached via the 3GPP FDD main menu.

The filter parameters (**Filter** section), clipping (**Clipping** section) and the sequence length of the arbitrary waveform component (**ARB Settings** section) are defined in this menu.

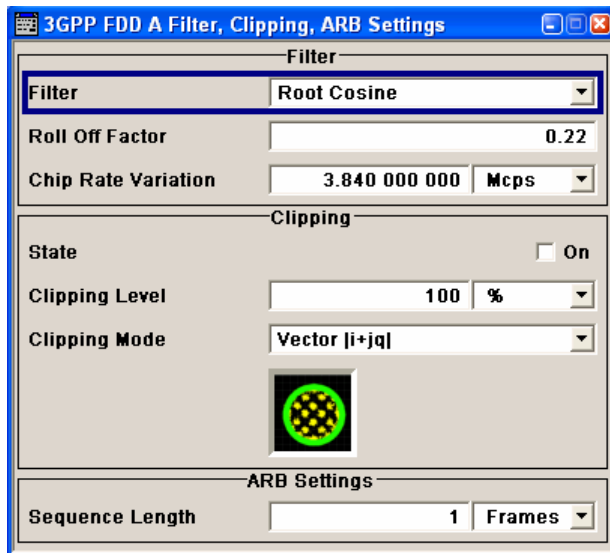

In the **Filter** section, the settings are made for the baseband filter.

**Filter - 3GPP FDD**

Selects baseband filter.

This opens a selection window containing all the filters available to the instrument.

The filter types are described in Section "[Baseband Filter - Custom Digital Mod](#)".

Remote-control command:

```
SOUR:BB:W3GP:FILT:TYPE RCOS
```



**Roll Off Factor or BxT - 3GPP FDD**

Enters the filter parameters.

The filter parameter offered (Roll Off factor or BxT) depends on the currently selected filter type. This parameter is always set to the default for each of the predefined filters.

Remote-control commands:

```
SOUR:BB:W3GP:FILT:PAR:APCO25 0.2
SOUR:BB:W3GP:FILT:PAR:COS 0.35
SOUR:BB:W3GP:FILT:PAR:GAUS 0.5
SOUR:BB:W3GP:FILT:PAR:RCOS 0.35
SOUR:BB:W3GP:FILT:PAR:SPH 2
```

**Chip Rate Variation - 3GPP FDD**

Enters the chip rate. The default settings for the chip rate is 3.84 Mcps.

The chip rate entry changes the output clock and the modulation bandwidth, as well as the synchronization signals that are output. It does not affect the calculated chip sequence.

Remote-control command:

```
SOUR:BB:W3GP:CRAT:VAR 4096001
```

The settings for clipping are collected in the **Clipping** section.

**Clipping State - 3GPP FDD**

Switches baseband clipping on and off.

Baseband clipping is a very simple and effective way of reducing the crest factor of the WCDMA signal.

WCDMA signals may have very high crest factors particularly with many channels and unfavorable timing offsets. High crest factors entail two basic problems:

- The nonlinearity of the power amplifier (compression) causes intermodulation which expands the spectrum (spectral regrowth).
- Since the level in the D/A converter is relative to the maximum value, the average value is converted with a relatively low resolution. This results in a high quantization noise.

Both effects increase the adjacent-channel power.

With baseband clipping, all the levels are limited to a settable value (**Clipping Level**). This level is specified as a percentage of the highest peak value. Since clipping is done prior to filtering, the procedure does not influence the spectrum. The EVM however increases.

Since clipping the signal not only changes the peak value but also the average value, the effect on the crest factor is unpredictable. The following table shows the effect of the **Clipping** on the crest factor for typical scenarios.

Remote-control command:

```
SOUR:BB:W3GP:CLIP:STAT ON
```

Table 4-19 Changing the crest factor by clipping (vector mode  $|i+q|$ ) for signal configurations with different output crest factors. 100% clipping levels mean that clipping does not take place.

Clipping level	Downlink: 10 DPCHs "Minimum Crest" 30 ksp	Downlink: 10 DPCHs "Worst Crest" 30 ksp	Downlink: 10 DPCHs "Average Crest" 30 ksp	Downlink: 128 DPCHs "Average Crest" 30 ksp
100%	9.89 dB	14.7 dB	10.9 dB	21.7 dB
80%	8.86 dB	12.9 dB	9.39 dB	20.2 dB
50%	7.50 dB	10.1 dB	8.29 dB	16.9 dB
20%	5.50 dB	6.47 dB	6.23 dB	12.5 dB
10%	5.34 dB	6.06 dB	5.80 dB	9.57 dB
5%	5.34 dB	6.06 dB	5.80 dB	8.17 dB

The following pictures demonstrate the affect of clipping with vector mode  $(|i+q|)$ , using a signal configuration with 4 DPCH as an example.

The arrows and the circle in the upper illustration show how the levels are mapped during subsequent clipping in vector mode  $(|i+q|)$ .

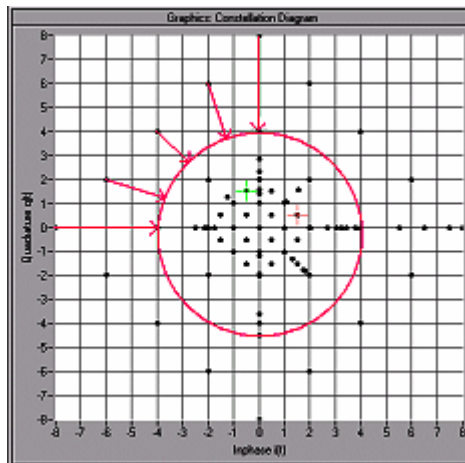

Fig. 4-22 Constellation diagram of the signal without clipping, shows the level mapping for vector mode

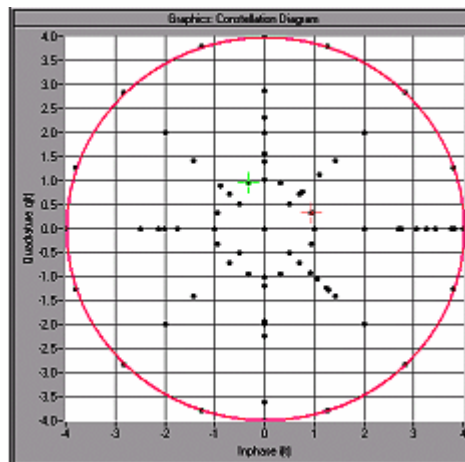

Fig. 4-23 Constellation diagram with clipping level 50 %, vector mode  $(|i+q|)$

**Clipping Level- 3GPP FDD** Sets the limit for clipping.  
This value indicates at what point the signal is clipped. It is specified as a percentage, relative to the highest level. 100% indicates that clipping does not take place.

Remote-control command:

SOUR:BB:W3GP:CLIP:LEV 50

**Clipping Mode - 3GPP FDD** Selects the clipping method. A graphic illustration of the way in which these two methods work is given in the menu.

**Vector | i + q |** The limit is related to the amplitude  $|i + q|$ . The I and Q components are mapped together, the angle is retained (see also Clipping State Fig. 4-22 and Fig. 4-23, Page 4.334).

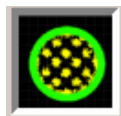

Remote-control command:

SOUR:BB:W3GP:CLIP:MODE VECT

**Scalar  $|i| + |q|$**  The limit is related to the absolute maximum of all the I and Q values  $|i| + |q|$ .

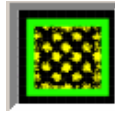

The I and Q components are mapped separately, the angle changes.

In the picture below, the square and the arrows show how the levels are mapped for clipping level 50% in scalar mode ( $|i| + |q|$ ).

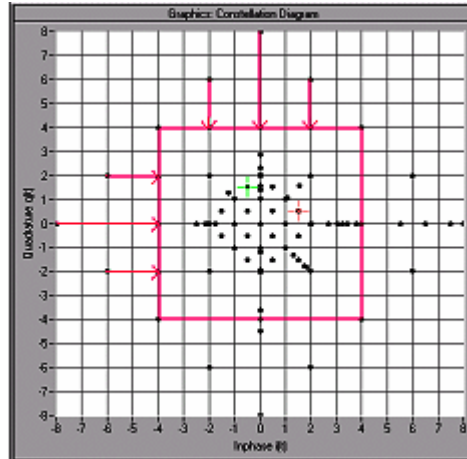

Fig. 4-24 Constellation diagram of the signal with 4 DPCH without clipping, shows the level mapping in scalar mode

Remote-control command:

SOUR:BB:W3GP:CLIP:MODE SCAL

The **ARB Settings** section is where the sequence length of the arbitrary waveform component is defined.

### Sequence Length ARB - 3GPP FDD

Changes the sequence length of the arbitrary waveform component of the 3GPP signal in the number of frames. This component is calculated in advance and output in the arbitrary waveform generator. It is added to the realtime signal components (enhanced channels).

The signal length is normally exactly one frame (10 ms, 38.400 chips).

In pure amplifier tests with several channels and no enhanced channels, it is possible to improve the statistical properties of the signal by increasing the sequence length.

Remote-control command:

SOUR:BB:W3GP:SLEN 20

## Trigger/Marker/Clock - 3GPP FDD

The **Trigger/Marker/Clock** menu can be reached via the 3GPP FFD main menu.

The **Trigger In** section is where the trigger for the 3GPP FDD signal is set. Various parameters will be provided for the settings, depending on which trigger source - internal or external - is selected. The current status of signal generation (**Running** or **Stopped**) is indicated for all trigger modes.

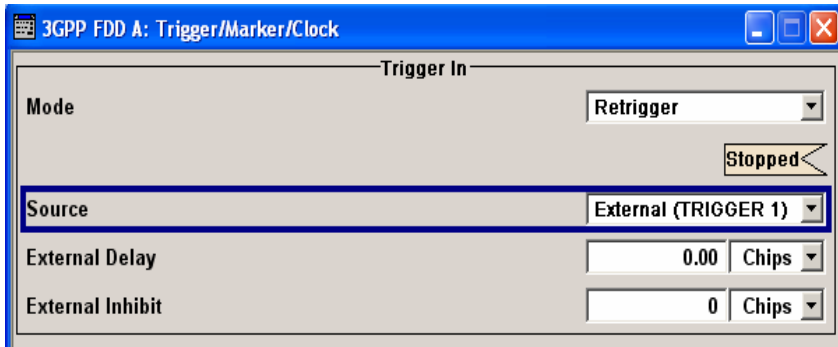

The **Marker Mode** section is where the marker signals at the MARKER output connectors are configured.

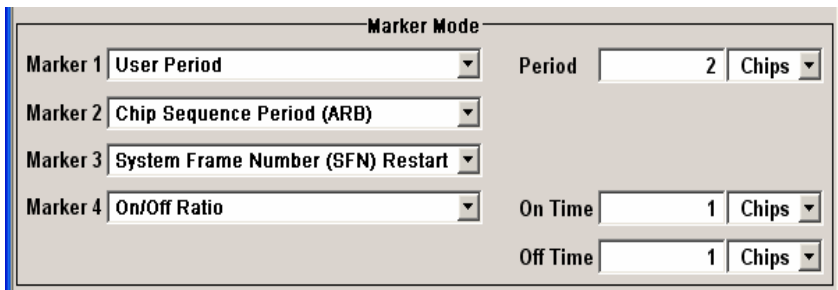

The **Marker Delay** section is where a marker signal delay can be defined, either without restriction or restricted to the dynamic section, i.e., the section in which it is possible to make settings without restarting signal and marker generation.

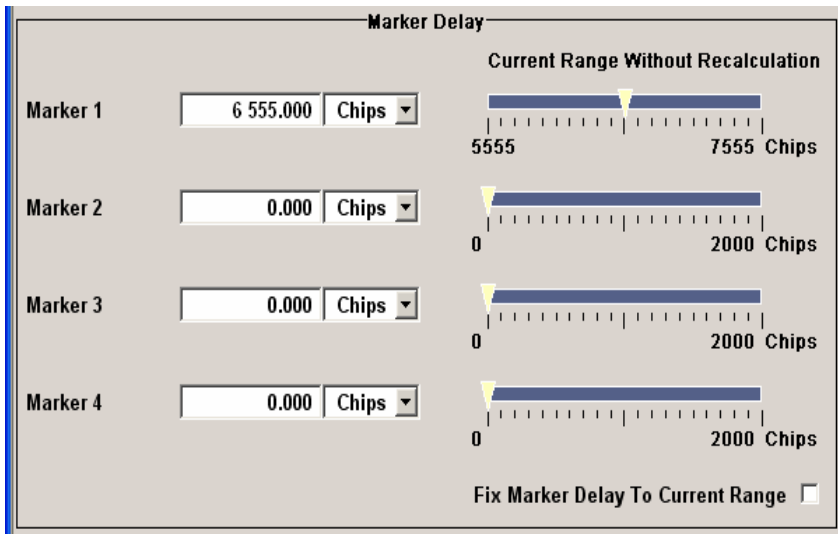

The **Clock Settings** section is where the clock source is selected and - in the case of an external source - the clock type.

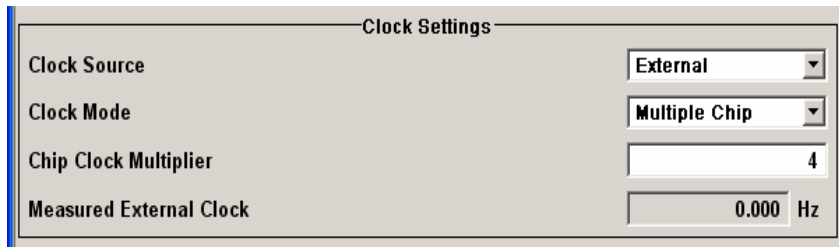

Clock Settings	
Clock Source	External
Clock Mode	Multiple Chip
Chip Clock Multiplier	4
Measured External Clock	0.000 Hz

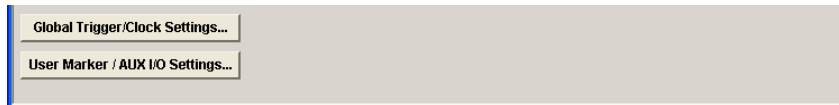

Global Trigger/Clock Settings...
User Marker / AUX I/O Settings...

The **Global Trigger/Clock Settings...** button calls a submenu for general trigger and clock settings and a submenu for defining the AUX I/Q interface.

The **User Marker/AUX I/O Settings...** button calls a submenu for mapping configuration.

The **Trigger In** section is where the trigger for the 3GPP FDD signal is set. The current status of the signal generation is displayed for all trigger modes.

**Trigger Mode - 3GPP FDD** Selects trigger mode.

The trigger mode determines the effect of a trigger on the signal generation.

**Auto** The 3GPP FDD signal is generated continuously.

Remote-control command:  
SOUR:BB:W3GP:SEQ AUTO

**Retrigger** The 3GPP FDD signal is generated continuously. A trigger event (internal or external) causes a restart.

Remote-control command:  
SOUR:BB:W3GP:SEQ RETR

**Armed Auto** The 3GPP FDD signal is generated only when a trigger event occurs. Then the signal is generated continuously.

Button **Arm** stops signal generation. A subsequent trigger event (internal with **Execute Trigger** or external) causes a restart.

Remote-control command:  
SOUR:BB:W3GP:SEQ AAUT

**Armed Retrigger**

The 3GPP FDD signal is generated only when a trigger event occurs. Then the signal is generated continuously. Every subsequent trigger event causes a restart.

Button **Arm** stops signal generation. A subsequent trigger event (internal with **Execute Trigger** or external) causes a restart.

Remote-control command:

SOUR:BB:W3GP:SEQ ARET

**Single**

The 3GPP FDD signal is generated only when a trigger event occurs. Then the signal is generated once to the length specified at **Signal Duration**. Every subsequent trigger event (internal with **Execute Trigger** or external) causes a restart.

**Note:**

*The signal length is the ARB sequence length or four frames for real time generation.*

Remote-control command:

SOUR:BB:W3GP:SEQ SING

**Signal Duration Unit - 3GPP FDD**

Defines the unit for the entry of the length of the signal sequence to be output in the **Single** trigger mode. Available units are chip sequence length (CLS), chips, slots, or frames.

Remote-control commands:

SOUR:BB:W3GP:TRIG:SLUN CHIP

**Signal Duration - 3GPP FDD**

Defines the length of the signal sequence to be output in the **Single** trigger mode. The input is to be expressed in chips, slots, or numbers of frames. It is then possible to output deliberately just part of the signal, an exact sequence of the signal, or a defined number of repetitions of the signal.

Remote-control commands:

SOUR:BB:W3GP:TRIG:SLEN 2000

**Running/Stopped - 3GPP FDD**

Displays the status of signal generation for all trigger modes. This display appears only when 3GPP FDD is enabled (**State On**).

Remote-control command:

SOUR:BB:W3GP:TRIG:RMOD?

Response: RUN or STOP

**Running** The 3GPP FDD modulation signal is generated; a trigger was (internally or externally) initiated in triggered mode.

If **Armed Auto** or **Armed Retrigger** have been selected, generation of signals can be stopped with the **Arm** button. A new trigger (internally with **Execute Trigger** or externally) causes a restart.

**Stopped** The signal is not generated, and the instrument waits for a trigger event (internal or external).

#### **Arm - 3GPP FDD**

Stops signal generation. This button appears only with **Running** signal generation in the **Armed Auto** and **Armed Retrigger** trigger modes.

Signal generation can be restarted by a new trigger (internally with **Execute Trigger** or externally).

Remote-control command:

```
SOUR:BB:W3GP:TRIG:ARM:EXEC
```

#### **Execute Trigger - 3GPP FDD**

Executes trigger manually. A manual trigger can be executed only when an internal trigger source and a trigger mode other than Auto have been selected.

Remote-control commands:

```
SOUR:BB:W3GP:TRIG:SOUR INT
```

```
SOUR:BB:W3GP:SEQ RETR
```

```
SOUR:BB:W3GP:TRIG:EXEC
```

**Trigger Source - 3GPP FDD** Selects trigger source. This setting is effective only when a trigger mode other than Auto has been selected.

**Internal** The trigger event is executed by **Execute Trigger**.

Remote-control command::

```
SOUR:BB:W3GP:TRIG:SOUR INT
```

**Internal (Baseband A/B)** The trigger event is executed by the trigger signal from the second path (two-path instruments only).

Remote-control command:

```
SOUR:BB:W3GP:TRIG:SOUR OBAS
```



**External  
(TRIGGER 1 / 2)**

The trigger event is executed with the aid of the active edge of an external trigger signal. The trigger signal is supplied via the TRIGGER 1 or TRIGGER 2 connector.

The polarity, the trigger threshold and the input impedance of the TRIGGER input can be set in the **Global Trigger/Clock Settings** menu.

Remote-control command:

```
SOUR:BB:W3GP:TRIG:SOUR EXT | BEXT
```

**External/Trigger Delay -  
3GPP FDD**

Sets trigger signal delay in chips on external triggering or on internal triggering via the second path.

This enables the R&S Vector Signal Generator to be synchronized with the device under test or other external devices (only Trigger Source External / Internal Other baseband).

**Note:**

*The delay can be set separately for each of the two paths.*

Remote-control command:

```
SOUR:BB:W3GP:TRIG:EXT:DEL 3
SOUR:BB:W3GP:TRIG:OBAS:DEL 3
```

**External/Trigger Inhibit -  
3GPP FDD**

Sets the duration for inhibiting a new trigger event subsequent to triggering. The input is to be expressed in chips (only Trigger Source External / Internal Other baseband).

In the **Retrigger** mode, every trigger signal causes signal generation to restart. This restart is inhibited for the specified number of chips.

This parameter is only available on external triggering or on internal triggering via the second path.

**Note:**

*The trigger inhibit can be set separately for each of the two paths.*

Remote-control command:

```
SOUR:BB:W3GP:TRIG:EXT:INH 1000
SOUR:BB:W3GP:TRIG:OBAS:INH 1000
```

The marker output signal for synchronizing external instruments is configured in the **Marker Settings** section **Marker Mode**.

## Marker Mode - 3GPP FDD

Selects a marker signal for the associated MARKER output.

Marker 1	Chip Sequence Period (ARB)
Marker 2	Slot
Marker 3	Chip Sequence Period (ARB) System Frame Number (SFN) Restart
Marker 4	User Period On/Off Ratio

**Slot**

A marker signal is generated at the start of each slot (every 2560 chips or 0.667 ms).

**Note:**

*Marker 4 must be set to **Slot** mode if Dynamic Power Control with external control signal is active.*

Remote-control command:

```
SOUR:BB:W3GP:TRIG:OUTP1:MODE SLOT
```

**Radio Frame**

A marker signal is generated at the start of each frame (every 38400 chips or 10 ms).

Remote-control command:

```
SOUR:BB:W3GP:TRIG:OUTP1:MODE RFR
```

**Chip Sequence Period (ARB)**

A marker signal is generated at the start of every arbitrary waveform sequence (depending on the setting for the arbitrary waveform sequence length). If the signal does not contain an arbitrary waveform component, a radio frame trigger is generated.

Remote-control command:

```
SOUR:BB:W3GP:TRIG:OUTP1:MODE CSP
```

**System Frame Number (SFN) Restart**

A marker signal is generated at the start of every SFN period (every 4096 frames).

Remote-control command:

```
SOUR:BB:W3GP:TRIG:OUTP1:MODE SFNR
```

**ON/OFF Ratio**

A regular marker signal that is defined by an ON/OFF ratio is generated. A period lasts one ON and OFF cycle.

Start of signal

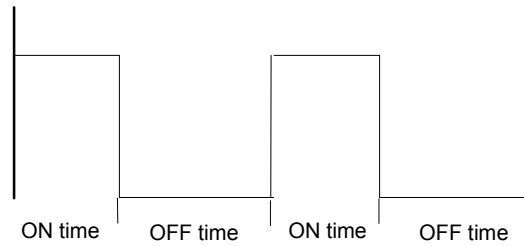

The ON time and OFF time are each expressed as a number of chips and are set in an input field which opens when **ON/OFF ratio** is selected.

On Time  Chips   
 Off Time  Chips

**Remote-control commands:**

```
SOUR:BB:W3GP:TRIG:OUTP1:MODE RAT
SOUR:BB:W3GP:TRIG:OUTP1:OFFT 20
SOUR:BB:W3GP:TRIG:OUTP1:ONT 20
```

**User Period**

A marker signal is generated at the beginning of every user-defined period. The period is defined in **Period**.

Period  Chips

This can be used, for instance, to generate a pulse at the start of each transport block (e.g. TTI 20 ms or 40 ms).

**Remote-control command :**

```
SOUR:BB:W3GP:TRIG:OUTP1:MODE USER
SOUR:BB:W3GP:TRIG:OUTP1:PER 614400
```

The **Marker Delay** section can be used to set a delay for the markers.

**Marker x Delay - 3GPP FDD** Enters the delay between the marker signal at the marker outputs and the start of the signal.

The input is expressed as a number of chips.

If the setting "**Fix marker delay to dynamic range**" is enabled, the setting range is restricted to the dynamic range. In this range the delay of the marker signals can be set without restarting the marker and signal.

The allocation of marker signals to the outputs is described in the section "[Marker Output Signals](#)".

Remote-control command:

```
SOUR:BB:W3GP:TRIG:OUTP2:DEL 20
```

**Current Range without Calculation - 3GPP FDD**

Displays the dynamic range within which the delay of the marker signals can be set without restarting the marker and signal.

The delay can be defined by moving the setting mark.

Remote-control command:

```
SOUR:BB:W3GP:TRIG:OUTP2:DEL:MAX?
```

```
SOUR:BB:W3GP:TRIG:OUTP2:DEL:MIN?
```

**Fix marker delay to current range - 3GPP FDD**

Restricts the marker delay setting range to the dynamic range. In this range the delay can be set without restarting the marker and signal.

Remote-control command:

```
SOUR:BB:W3GP:TRIG:OUTP:DEL:FIX ON
```

The clock source is selected in the **Clock Settings** section.

**Clock Source - 3GPP FDD**

Selects the clock source (also see section "[Clock Signals](#)").

**Internal**

The internal clock reference is used to generate the chip clock.

Remote-control command:

```
SOUR:BB:W3GP:CLOC:SOUR INT
```

**External**

The external clock reference is fed in as the chip clock or multiple thereof via the CLOCK connector.

The chip rate must be correctly set to an accuracy of  $\pm 2\%$  (see data sheet).

The polarity of the clock input can be changed with the aid of **Global Trigger/Clock Settings**.

In the case of two-path instruments this selection applies to path A

Remote-control command:

```
SOUR:BB:W3GP:CLOC:SOUR EXT
```

<b>Clock Mode - 3GPP FDD</b>	<p>Enters the type of externally supplied clock.</p> <p><b>Chip</b> A chip clock is supplied via the CLOCK connector.</p> <p>Remote-control command : SOUR:BB:W3GP:CLOC:MODE CHIP</p> <p><b>Multiple Chip</b> A multiple of the chip clock is supplied via the CLOCK connector; the chip clock is derived internally from this.</p> <p>The <b>Multiplier</b> window provided allows the multiplication factor to be entered.</p> <p>Remote-control command: SOUR:W3GP:CLOC:MODE MCH</p>
<b>Chip Clock Multiplier - 3GPP FDD</b>	<p>Enters the multiplication factor for clock type <b>Multiple</b>.</p> <p>Remote-control command: SOUR:BB:W3GP:CLOC:MULT 4</p>
<b>Measured External Clock - 3GPP FDD</b>	<p>Displays the measured frequency of the external clock signal. This enables the user to permanently monitor the frequency of the externally introduced clock.</p> <p>This information is displayed only if the external clock source has been selected.</p> <p>Remote-control command: :CLOC:INP:FREQ?</p>
<b>Global Trigger/Clock Settings - 3GPP FDD</b>	<p>Calls the <b>Global Trigger/Clock/Input Settings</b> menu. This menu is used among other things for setting the trigger threshold, the input impedance and the polarity of the clock and trigger inputs.</p> <p>In the case of two-path instruments these settings are valid for both paths.</p> <p>The parameters in this menu affect all digital modulations and standards, and are described in the section "<a href="#">Global Trigger/Clock/Input Settings – Setup -Environment</a>".</p>
<b>User Marker/AUX I/O Settings – 3GPP FDD</b>	<p>Calls the <b>UserMarker/AUX I/O</b> menu. This menu is used for mapping configuration.</p> <p>The parameters in this menu affect all digital modulations and standards, and are described in the section "<a href="#">Global Trigger / Clock / Input Settings – Setup -Environment</a>".</p>

## Test Setups - Models - 3GPP FDD

The **Test Setups / Models** menu can be reached via the **3GPP FFD** main menu.

The menu offers various test models, depending on which transmission direction is set. The presettings are defined in the 3GPP standard TS 25.141.

### Test Models Downlink-3GPP FDD

Opens a window in which to select a test model in accordance with the 3GPP standard TS 25.141.

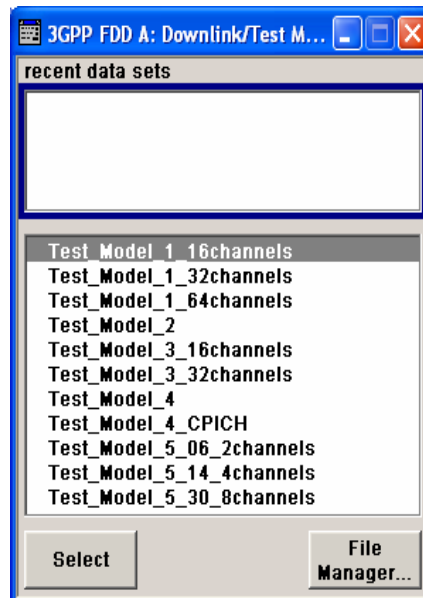

Selecting a test model for an active base station immediately generates the selected signal configuration.

The following test models are available for selection:

Test model	Settings
<b>Test Model 1 (16 channels)</b>	Spectrum emission mask ACLR Spurious emissions Transmit intermodulation Modulation accuracy Peak code domain error  Remote-control command: SOUR:BB:W3GP:SETT:TMOD:BST "Test_Model_1_16channels"

<b>Test Model 1 (32 channels)</b>	<p>Spectrum emission mask          ACLR          Spurious emissions          Transmit intermodulation          Modulation accuracy</p> <p>Remote-control command:          SOUR:BB:W3GP:SETT:TMOD:BST          "Test_Model_1_32channels"</p>
<b>Test Model 1 (64 channels)</b>	<p>Spectrum emission mask          ACLR          Spurious emissions          Transmit intermodulation          Modulation accuracy</p> <p>Remote-control command:          SOUR:BB:W3GP:SETT:TMOD:BST          "Test_Model_1_64channels"</p>
<b>Test Model 2</b>	<p>Output power dynamics</p> <p>Remote-control command:          SOUR:BB:W3GP:SETT:TMOD:BST          "Test_Model_2"</p>
<b>Test Model 3 (16 channels)</b>	<p>Peak code domain error</p> <p>Remote-control command:          SOUR:BB:W3GP:SETT:TMOD:BST          "Model_3_16channels"</p>
<b>Test Model 3 (32 channels)</b>	
<b>Test Model 4</b>	<p>Error Vector Magnitude, optional P-CPICH is not active</p> <p>Remote-control command:          SOUR:BB:W3GP:SETT:TMOD:BST          "Test_Model_4"</p>
<b>Test Model 4 _CPICH</b>	<p>Error Vector Magnitude, optional P-CPICH is active.</p> <p>Remote-control command:          SOUR:BB:W3GP:SETT:TMOD:BST          "Test_Model_4_CPICH"</p>

**Test Model 5**  
(8 HS-PDSCH + 30 DPCH) Error Vector Magnitude at base stations that support high speed physical downlink shared channels with 16 QAM

**Test Model 5**  
(4 HS-PDSCH + 14 DPCH) Remote-control command:  
"Test\_Model\_5\_30\_8channels"

**Test Model 5**  
(2 HS-PDSCH + 6 DPCH)

### Test Models Uplink- 3GPP FDD

Opens a window in which to select pre-defined test signals.

3GPP has not defined any test models for the Uplink transmission direction. But the R&S Vector Signal Generator also makes pre-defined test signals available for the Uplink, so that useful test signals can be generated at the press of a button.

All the Uplink test models are generated in the enhanced state of user equipment 1. The sequence length is 1 frame.

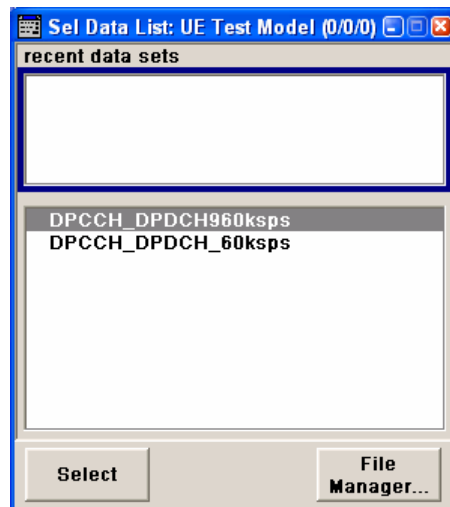

The following configurations are available for selection:

**DPCCH + DPDCH 60 ksps** User equipment 1 is activated in DPCCH + DPDCH mode. 60 ksps is selected as the overall symbol rate. All the other settings correspond to the preset setting.

Remote-control command:  
SOUR:BB:W3GP:SETT:TMOD:MST  
"DPCCH\_DPDCH\_60ksps"



**DPCCH +  
DPDCH 960  
ksps**

User equipment 1 is activated in DPCCH + DPDCH mode. 960 ksps is selected as the overall symbol rate. All the other settings correspond to the preset setting.

Remote-control command:  
SOUR:BB:W3GP:SETT:TMOD:MST  
"DPCCH\_DPDCH960ksps"

## Predefined Settings - Downlink - 3GPP FDD

The **Predefined Settings** can be reached via the **3GPP FDD** main menu. It is only available when the Downlink transmission direction is selected. The channel table of base station 1 is filled (preset) with the set parameters. The sequence length of the generated signal is 1 frame.

With the **Parameter Predefined** function, it is possible to create highly complex scenarios with just a few keystrokes. This function is of use if, say, just the envelope of the signal is of interest.

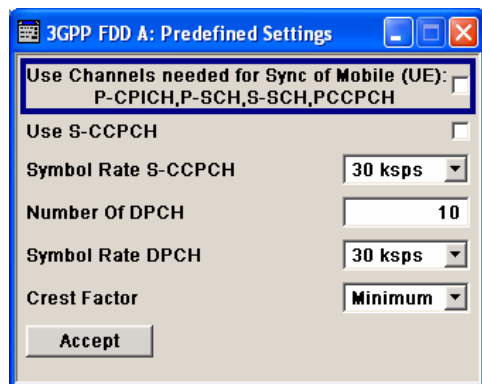

**Use Channels - 3GPP FDD (This feature is available in the downlink only.)**

Selects if P-CPICH, P-SCH, S-SCH and PCCPCH are used in the scenario or not. These "special channels" are required by a user equipment for synchronization.

Remote-control command:  
SOUR:BB:W3GP:PPAR:SCH ON

**Use S-CCPCH - 3GPP FDD (This feature is available in the downlink only.)**

Selects if S-CCPCH is used in the scenario or not.

Remote-control command:  
SOUR:BB:W3GP:PPAR:SCCP:STAT ON

**Symbol Rate S-CCPCH -  
3GPP FDD****(This feature is available in the downlink only.)**

Sets the symbol rate of S-CCPCH.

Remote-control command:

SOUR:BB:W3GP:PPAR:SCCP:SRAT D30K

**Number of DPCH - 3GPP  
FDD****(This feature is available in the downlink only.)**

Sets the number of activated DPCHs.

The maximum number is the ratio of the chip rate and the symbol rate (maximum 512 at the lowest symbol rate of 7.5 kps).

Remote-control command:

SOUR:BB:W3GP:PPAR:DPCH:COUN 512

**Symbol Rate DPCH - 3GPP  
FDD****(This feature is available in the downlink only.)**

Sets the symbol rate of all DPCHs.

Remote-control command:

SOUR:BB:W3GP:PPAR:DPCH:SRAT D30K

**Crest Factor - 3GPP FDD****(This feature is available in the downlink only.)**

Selects desired range for the crest factor of the test scenario. The crest factor of the signal is kept in the desired range by automatically setting appropriate channelization codes and timing offsets.

**Minimum**

The crest factor is minimized. The channelization codes are distributed uniformly over the code domain. The timing offsets are increased by 3 per channel.

Remote-control command:

SOUR:BB:W3GP:PPAR:CRES MIN

**Average**

An average crest factor is set. The channelization codes are distributed uniformly over the code domain. The timing offsets are all set to 0.

Remote-control command:

SOUR:BB:W3GP:PPAR:CRES AVER

**Worst**

The crest factor is set to an unfavorable value (i.e. maximum). The channelization codes are assigned in ascending order. The timing offsets are all set to 0.

Remote-control command:

SOUR:BB:W3GP:PPAR:CRES WORS

**Accept - 3GPP FDD****(This feature is available in the downlink only.)**

Presets the channel table of basestation 1 with the parameters defined in the **Predefined Settings** menu. Scrambling Code 0 is automatically selected (as defined in the 3GPP test models).

Remote-control command:

SOUR:BB:W3GP:PPAR:EXEC

**Additional User Equipment - Uplink - 3GPP FDD**

Submenu **Additional User Equipment** can be reached via the **3GPP FDD** main menu. It is only available when the Uplink transmission direction is selected.

The menu makes it possible to simulate up to 128 additional user equipment and thus to generate a signal that corresponds to the received signal for a base station with high capacity utilization.

The fourth user equipment (UE4) serves as a template for all other stations. The following parameters are the only ones modified for the additional user equipment:

- Scrambling code (different for all stations)
- Power (different to UE4, but identical among themselves)

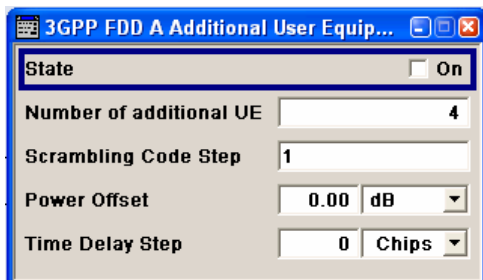
**State - 3GPP FDD****(This feature is available in the uplink only.)**

Activates additional user equipment. At **State Off**, all the additional user equipment are switched off.

Remote-control command:

SOUR:BB:W3GP:MST:ADD:STAT ON

**Number of Additional UE - 3GPP FDD****(This feature is available in the uplink only.)**

Sets the number of additional user equipment. As many as 128 additional user equipment can be simulated.

Remote-control command:

SOUR:BB:W3GP:MST:ADD:COUN 64

**Scrambling Code Step -  
3GPP FDD****(This feature is available in the uplink only.)**

Enters the step width for increasing the scrambling code of the additional user equipment. The start value is the scrambling code of UE4.

Remote-control command:

SOUR:BB:W3GP:MST:ADD:SCOD:STEP 5

**Power Offset - 3GPP FDD****(This feature is available in the uplink only.)**

Sets the power offset of the active channels of the additional user equipment to the power outputs of the active channels of UE4.

The resultant power must fall within the range 0 ... - 80 dB. If the value is above or below this range, it is limited automatically.

Remote-control command:

SOUR:BB:W3GP:MST:ADD:POW:OFFS -3

**Time Delay Step - 3GPP  
FDD****(This feature is available in the uplink only.)**

Enters the step width for the time delay of the additional user equipment to one another. The start value returns the time delay of UE4. Entry is made in chips and can be a maximum of 1 frame.

The time delay allows user equipment to be simulated even if the arrival of their signals is not synchronized at the base station.

Remote-control command:

SOUR:BB:W3GP:MST:ADD:TDEL:STEP 256

# Base Station Configuration - 3GPP FDD

The **Base Station Configuration** menu is called by selecting base station **BS1 ... BS4** in the **3GPP FDD** menu. Base stations can be configured independently of one another. Base station 1 (BS1) also includes enhanced channels (Enhanced Channels, Realtime).

The menu comprises the **Common Settings** section, in which the general parameters of the base station are set, a row containing the buttons **Multi Channel Assistant**, **Code Domain...** and **Channel Graph...**, which call the appropriate submenus and graphics and the most important part, the channel table with graphical display of the structure of the channel being edited.

Channel Type	Enhanced/HSDPA Settings	Slot Fmt	Symb Rate / kbps	Ch Code	Pow / dB	Data	DList / Pattern	T Offs	DPCCH Settings	State	Do Conf
0	P-CPICH		15	0	0.00					Off	
1	S-CPICH		15	0	0.00					Off	
2	P-SCH		15		0.00					Off	
3	S-SCH		15		0.00					Off	
4	P-CCPCH	Config...	15	1	0.00	PN 9				Off	
5	S-CCPCH		0	15	0	0.00	PN 9	0	Config...	Off	
6	PICH		15	0	0.00	PN 9		0		Off	
7	AICH		15	0	0.00				Config...	Off	
8	AP-AICH		15	0	0.00				Config...	Off	
9	PDSCH		0	15	0	0.00	PN 9		Config...	Off	
10	DL-DPCCH		0	7.5	0	0.00			Config...	Off	
11	DPCH	Config...	8	30	0	0.00	PN 9	0	Config...	Off	
12	HS-SCCH	Config...		30	5	-10.00	H-Set			On	
13	HS-PDS.QPSK			240	8	-20.00	PN 15			On	
14	HS-PDS.QPSK			240	9	-20.00	PN 15			On	
15	HS-PDS.QPSK			240	10	-20.00	PN 15			On	
16	HS-PDS.QPSK			240	11	-20.00	PN 15			On	

The general parameters of the base station are set in the **Common Settings** section.

<b>State - BS - 3GPP FDD</b>	<p>Activates or deactivates the selected base station. The number of the selected base station is displayed in the menu header.</p> <p>Remote-control command: SOUR:BB:W3GP:BST1:STAT ON</p>
<b>2<sup>nd</sup> Search Code Group - BS - 3GPP FDD</b>	<p>Displays the 2<sup>nd</sup> search code group.</p> <p>This parameter is specified in the table defined by the 3GPP standard "Allocation of SSCs for secondary SCH". This table assigns a specific spreading code to the synchronization code symbol for every slot in the frame. The value is calculated from the scrambling code.</p> <p>Remote-control command: SOUR:BB:W3GP:BST3:SSCG?</p>
<b>Scrambling Code State - BS - 3GPP FDD</b>	<p>Activates or deactivates the scrambling code. The scrambling code can be deactivated for test purposes.</p> <p>Remote-control command: SOUR:BB:W3GP:BST1:SCOD:STAT ON</p>
<b>Scrambling Code - BS - 3GPP FDD</b>	<p>Enters the base station identification. This value is also the initial value of the scrambling code generator (see also Section "<a href="#">Scrambling Code Generator</a>", Page 4.312).</p> <p>Remote-control command: SOUR:BB:W3GP:BST1:SCOD #H1</p>
<b>Page Indicators per Frame - BS - 3GPP FDD</b>	<p>Enters the number of page indicators (PI) per frame in the page indicator channel (PICH).</p> <p>Remote-control command: SOUR:BB:W3GP:BST2:PIND:COUN D36</p>
<b>Use S-CPICH as Phase Reference - BS - 3GPP FDD</b>	<p>Activates or deactivates the use of S-CPICH as reference phase.</p> <p>If activated the phase of S-CPICH and the phase of all DPCHs is 180 degrees offset from the phase of P-CPICH</p> <p>Remote-control command: SOUR:BB:W3GP:BST2:SCP:REF:STAT ON</p>

**Transmit Diversity - BS -  
3GPP FDD**

Switches transmit diversity on and off.

The signal can be sent simultaneously on several antennas. Various forms of transmit diversity are described in the 3GPP standard. Different coding is used to divide the signal between the two antennas. As a result, the receiver can decode the traffic signal from the two input signals and is less liable to fading and other interference. The R&S Vector Signal Generator can simulate the signal of one of the two antennas.

A fixed diversity scheme is assigned to each channel type:

DPCH, PCCPCH, SCCPH:  
STTD (space time block coding transmit antenna diversity).

Primary SCH, Secondary SCH:  
TSTD (time switched transmit diversity for SCH).

These two schemes are described in detail in TS 25.111.

To activate transmit diversity, the antennas whose signals are to be simulated must be specified:

**Off**                      No transmit diversity  
Remote-control command:  
SOUR:BB:W3GP:BST1:TDIV    OFF

**Antenna 1**              Calculate and apply the output signal for antenna 1  
Remote-control command:  
SOUR:BB:W3GP:BST1:TDIV    ANT1

**Antenna 2**              Calculate and apply the output signal for antenna 2  
Remote-control command:  
SOUR:BB:W3GP:BST1:TDIV    ANT2

**Time Delay- BS - 3GPP  
FDD**

**(This feature is available for BS 2...4 only.)**

Enters the time delay of the signal of the selected base station compared to the signal of base station 1.

Remote-control command:  
SOUR:BB:W3GP:BST2:TDEL 256

**Use Compressed Mode- BS  
- 3GPP FDD**

**(This feature is available for BS 2...4 only.)**

Activates compressed mode.

The Compressed mode is configured in the submenu called by button **Compressed Mode...**

Remote-control command:  
SOUR:BB:W3GP:BST2:CMOD:STAT ON

<b>Compressed Mode... - 3GPP FDD</b>	<p>Calls the menu for configuring the compressed mode.</p> <p>The menu is described in Section "<a href="#">Compressed Mode - BS - 3GPP FDD</a>", page 4.357.</p> <p>Remote-control command:</p>
<b>Preset Channel Table - 3GPP FDD</b>	<p>Calls the default settings for the channel table. Test Model 1 (64 channels) is preset.</p> <p>Remote-control command: SOUR:BB:W3GP:BST:CHAN:PRES</p>
<b>Multi Channel Assistant... - 3GPP FDD</b>	<p>Calls the menu for configuring several DPCH channels simultaneously.</p> <p>The menu is described in Section "<a href="#">Multi Channel Assistant - BS - 3GPP FDD</a>", Page 4.409.</p> <p>Remote-control command: n . a .</p>
<b>Code Domain... - 3GPP FDD</b>	<p>Calls a graphical display of the assigned code domain.</p> <p>The code domain graph is described in Section "<a href="#">Code Domain Graph - BS - 3GPP FDD</a>", Page 4.362.</p> <p>Remote-control command:</p>
<b>Channel Graph... - Base Station - 3GPP FDD</b>	<p>Opens the channel graph display to visually check the configured signal.</p> <p>The channel graph is described in Section "<a href="#">Channel Graph - Base Station - 3GPP FDD</a>", page 4.365.</p> <p>Remote-control command: n . a .</p>
<b>Preset Channel Table HSDPA- 3GPP FDD</b>	<p><b>(This feature is available for BS 1 only.)</b></p> <p>Calls the default settings of the channel table for the HSDPA H-Set mode. Channels 12 to 17 are preset for HSDPA H-Set 1.</p> <p>Remote-control command: SOUR:BB:W3GP:BST:CHAN:HSDP:HSET:PRES</p>



## Compressed Mode - BS - 3GPP FDD

To enable handover of a mobile station from a 3GPP FDD base station to another base station, (3GPP FDD, 3GPP TDD or GSM) at a different frequency, transmission and reception of the 3GPP FDD signal must be interrupted for a short time. During this time, the mobile station changes to the frequency of the new base station, for example to measure the receive level of this station or read system information.

To transmit a consistently high data volume also in the remaining (shorter) period of time, the data is compressed. This can be done by halving the spreading factor (SF/2 method) or reducing error protection (puncturing method). In both cases, transmit power in the ranges concerned is increased to maintain adequate signal quality.

Apart from these two methods, there is also the method of "higher layer scheduling". With this method, transmission of the data stream is stopped during the transmission gap. This method is suitable for packet-oriented services; it involves no power increase (power offset) in the active ranges.

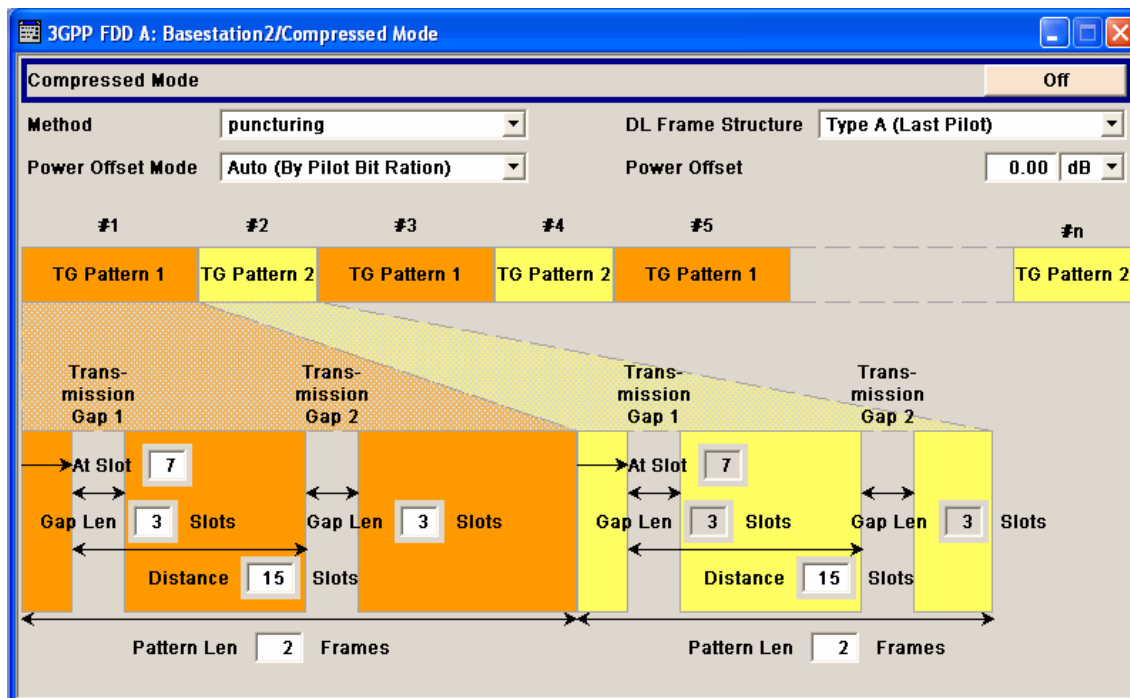

**Compressed Mode State - (This feature is available for BS 2...4 only.)**  
BS - 3GPP FDD

Activates compressed mode.

Remote-control command:

```
SOUR:BB:W3GP:BST2:CMOD:STAT ON
```

**Compressed Mode Method (This feature is available for BS 2...4 only.)**  
- BS - 3GPP FDD

Selects compressed mode method.

**puncturing**

The data is compressed by reducing error protection.

Remote-control command:

```
SOUR:BB:W3GP:BST2:CMOD:METH PUNC
```

**Higher layer scheduling**

The data is compressed by stopping the transmission of the data stream during the transmission gap.

Remote-control command:

```
SOUR:BB:W3GP:BST2:CMOD:METH HLSC
```

**SF/2**

The data is compressed by halving the spreading factor.

This method can be demonstrated in the code domain graph. The graph is split into two windows. The upper window shows the code domain assignment with non-compressed slots, the lower window with compressed slots. It can be recognized clearly that the DPCH bars in the lower window are wider, which is due to the reduction of the spreading factor of these channels. The other channels (e.g. CPICH) have the same width in both halves.

Remote-control command:

```
SOUR:BB:W3GP:BST2:CMOD:METH SF2
```

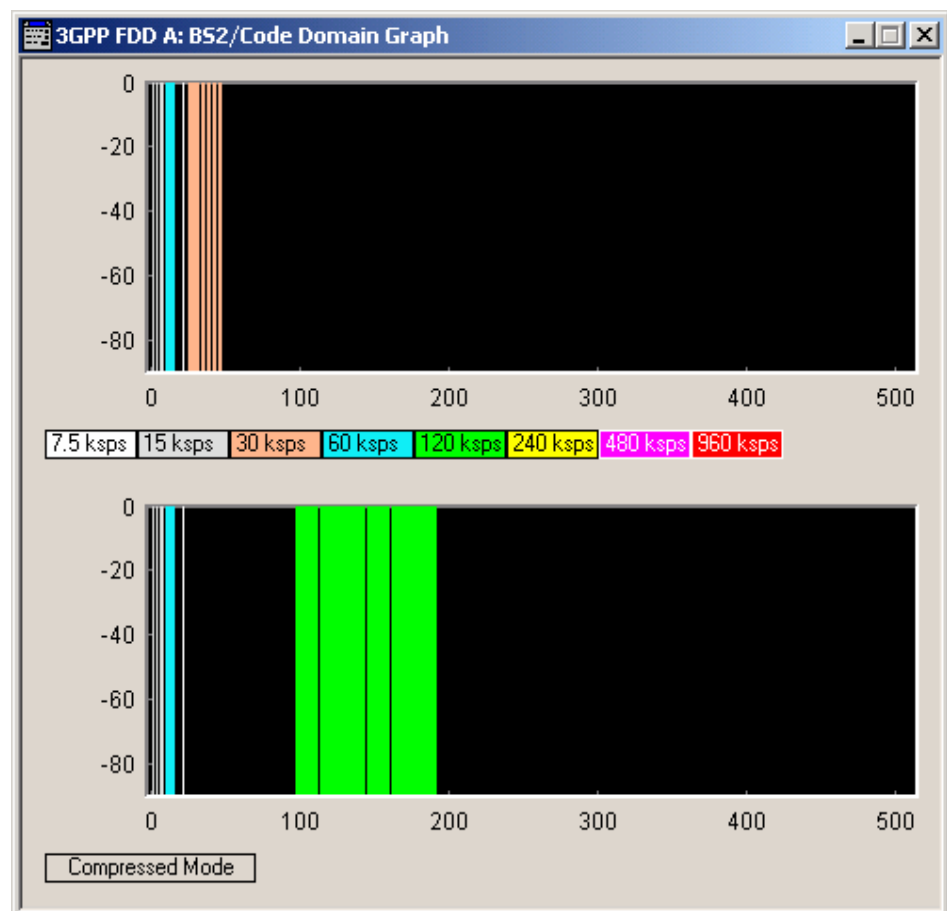

**DL Frame Structure - BS - 3GPP FDD**

**(This feature is available for BS 2...4 only.)**

Selects frame structure. The frame structure determines the transmission of TPC and pilot field in the transmission gaps.

For 3GPP FDD radiocommunication to operate, the mobile station receiver requires information in the pilot field for synchronization and channel estimation and in the power control field TPC for control of the mobile station transmit power.

To keep the period during which no channel estimation takes place as short as possible, the pilot is sent in the last slot of each transmission gap.

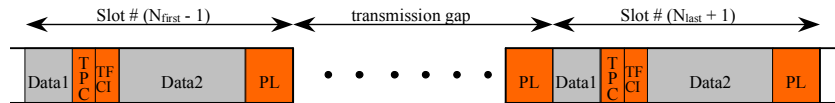

Optionally, the first TPC field of the transmission gap can be sent in addition.

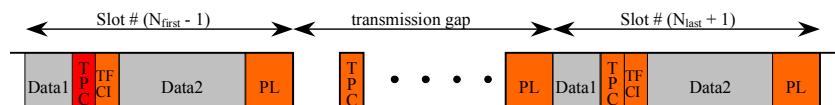

**Type A (Last Pilot)**

The pilot field is sent in the last slot of each transmission gap.

Remote-control command:  
SOUR:BB:W3GP:BST2:CMOD:DLFS A

**Type B (First TPC, Last Pilot)**

The pilot field is sent in the last slot of each transmission gap. The first TPC field of the transmission gap is sent in addition.

Remote-control command:  
SOUR:BB:W3GP:BST2:CMOD:DLFS B

**Power Offset Mode - BS - 3GPP FDD**

**(This feature is available for BS 2...4 only.)**

Selects power offset mode.

The compressed slots can be sent with a power offset, i.e. at an increased power level.

**Auto (By Pilot Bit Ratio)**

The power offset is obtained as follows:  
$$\frac{\text{Number of pilots bits of non-compressed slots}}{\text{Number of pilot bits by compressed slots}}$$

Remote-control command:  
SOUR:BB:W3GP:BST2:CMOD:POM AUTO

**User**

The power offset is defined manually. The value is input in entry field **Power offset**.

Remote-control command:  
SOUR:BB:W3GP:BST2:CMOD:POM USER

**Power Offset - BS - 3GPP FDD**

**(This feature is available for BS 2...4 only.)**

Defines power offset. The entered value is only valid for Power Offset Mode User. The value range is 0 dB to 10 dB.

Remote-control command:

SOUR:BB:W3GP:BST2:CMOD:POFF 3dB

**Compressed Mode Configuration Graph - BS - 3GPP FDD**

The remaining parameters of the compressed mode are set in the configuration graph. The graph displays the distribution of transmission gaps in a compressed mode signal.

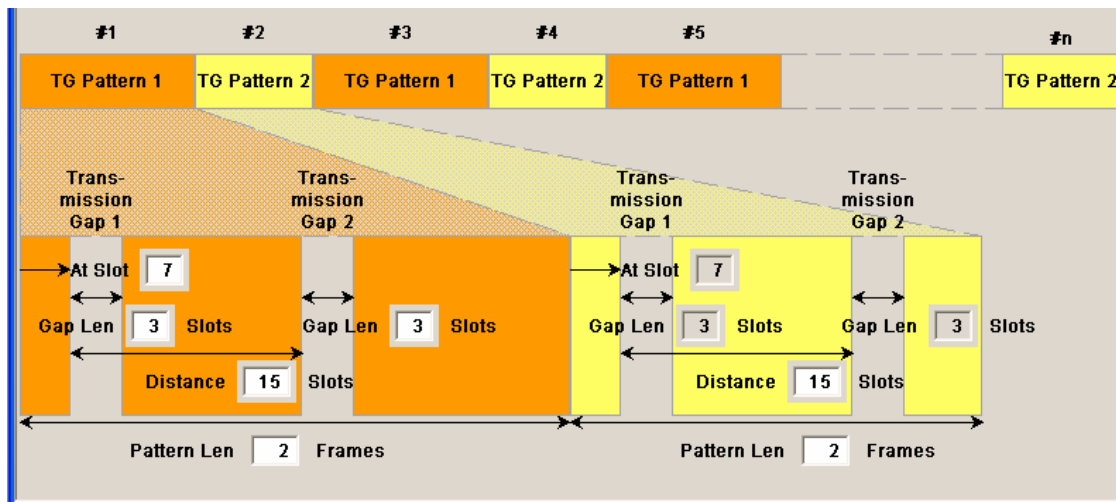

The signal generated can be divided into three subranges.

**Transmission Gaps**

A transmission gap has a maximum length of 14 slots. Since at least eight active slots must be sent per frame, gaps comprising seven slots and more have to be distributed over two neighboring frames.

The transmitted signal consists of max. two patterns that are sent alternately. Each pattern comprises two transmission gaps.

The graph includes all parameters necessary to define the transmission gaps in the signal.

**Note:**

*The settings in the graph are also valid for the compressed mode graph of the user equipment with the same number. For example, setting a distance of 9 slots for base station 4 also sets the distance to 9 slots for user equipment 4.*

**At Slot:**

**(This feature is available for BS 2...4 only.)**

Transmission gap slot number. Slot number of pattern 2 is the same as slot number of pattern 1.

Remote-control command:

SOUR:BB:W3GP:BST2:CMOD:PATT1:TGSN 4

- Gap Len:** (This feature is available for BS 2...4 only.)  
Transmission gap lengths. Gap lengths of pattern 2 is the same as gap lengths of pattern 1.  
Remote-control command:  
SOUR:BB:W3GP:BST2:CMOD:PATT1:TGL2 7
- Distance** (This feature is available for BS 2...4 only.)  
Transmission gap distance.  
Remote-control command:  
SOUR:BB:W3GP:BST2:CMOD:PATT2:TGD 4
- Pattern Len:** (This feature is available for BS 2...4 only.)  
Transmission gap pattern length.  
The input range is 0 ... 100 frames for pattern 1 and 1 ... 100 frames for pattern 2. Thus, it is possible to configure transmission gap pattern with only one pattern.  
Remote-control command:  
SOUR:BB:W3GP:BST2:CMOD:PATT2:TGPL 23

The above parameters are interrelated in many ways. For example, the transmission gap distance must be selected so that no frame contains more than one gap. In the event of an invalid entry, the next valid value is automatically set. If the entry is valid but changes the valid range for another parameter, the setting of the parameter is adapted.

In the above example, the signal (or more precisely: the pattern of transmission gaps) is repeated every 4 frames.

### Compressed Ranges

All slots of a frame that are not blanked are compressed. If the transmission gap is transmitted within one frame (single-frame method), an envelope as shown by the diagram below is obtained:

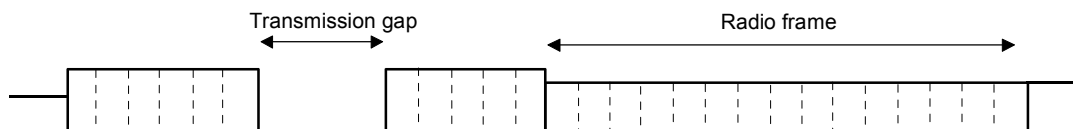

Fig. 4-25 Envelope of compressed mode signal with single-frame method

If the transmission gap is distributed over two neighboring frames, all slots of the two frames that are not blanked are compressed:

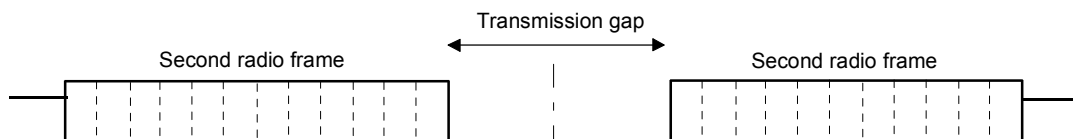

Fig. 4-26 Envelope of compressed mode signal with double-frame method

A different slot format, usually with a higher number of pilot bits, is used in the compressed ranges.

The transmit power can be increased (**Power Offset Mode**) automatically or manually by defining a power offset.

**Non-compressed ranges**

Frames containing no transmission gaps are sent with the same slot format and the same power as in the non-compressed mode.

**Code Domain Graph – BS – 3GPP FDD**

The channelization codes are taken from a code tree of hierarchical structure (see below).

The higher the spreading factor, the smaller the symbol rate and vice versa. The product of the spreading factor and symbol rate is constant and always yields the chip rate.

The outer branches of the tree (right-most position in the figure) indicate the channelization codes for the smallest symbol rate (and thus the highest spreading factor). The use of a channelization code of the level with spreading factor N blocks the use of all other channelization codes of levels with spreading factor >N available in the same branch of the code tree. Channelization codes with smaller spreading factor are contained in the codes with larger spreading factor in the same code branch. When using such competitive channelization codes at the same time, the signals of associated code channels are mixed such that they can no longer be separated in the receiver. Orthogonality will then be lost.

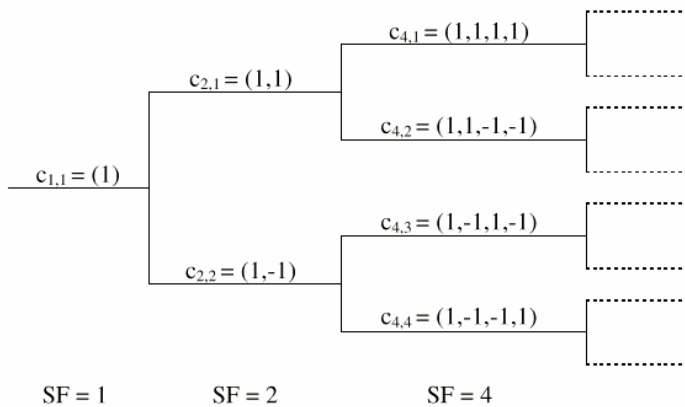

Fig. 4-27 Code tree of channelization codes

The outer branches of the tree (right-most position in the figure) indicate the channelization codes for the smallest symbol rate (and thus the highest spreading factor). The use of a channelization code of the level with spreading factor N blocks the use of all other channelization codes of levels with spreading factor >N available in the same branch of the code tree.

**Example:** If code  $c_{2,1}$  is being used, the remaining branch with  $c_{4,1}$  and  $c_{4,2}$  is blocked.

The **domain** of a certain channelization code is the outer branch range (with minimum symbol rate and max. spreading factor) which is based on the channelization code selected in the code tree. Using a spreading code means that its entire domain is used.

At a chip rate of 3.84 Mcps, the domain ranges from 0 to 511

$$= \frac{\text{Chip\_rate}}{\text{min\_Symbol\_rate}} - 1 = \frac{3.84\text{Mcps}}{7.5\text{ksps}} - 1$$

The **Code Domain** display indicates the assigned code domain. The channelization code is plotted at the X axis, the colored bars indicate coherent code channels. The colors are assigned to fixed symbol rates, the allocation is shown below the graph. The relative power can be taken from the height of the bar.

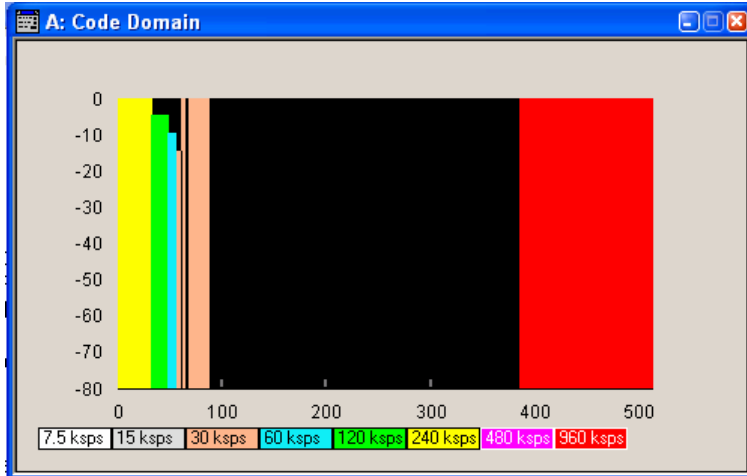

It is possible to determine from this display whether the settings made have resulted in a code domain conflict, that is to say, whether the code domains of the active channels intersect. A code domain conflict is indicated by overlapping bars:

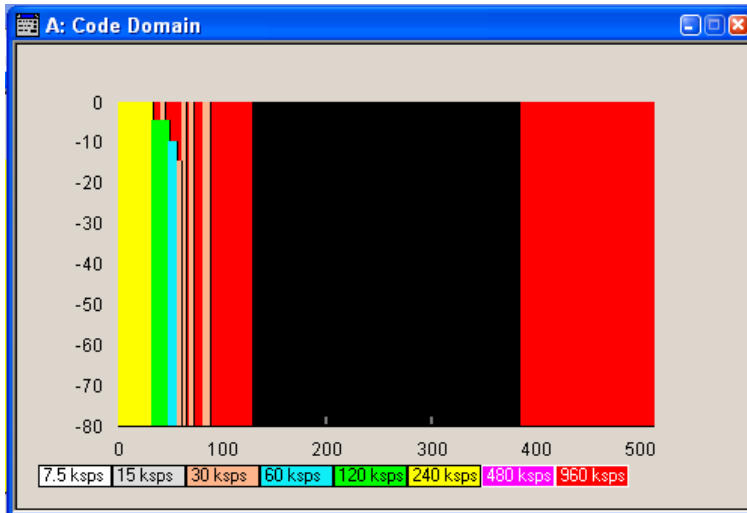

**Note:**

*The graph is calculated from the settings that have been made. The code domain display for the measured signal can be called from the **Graphics** menu (**Graphics** function block).*

In the channel table, a code domain conflict with an overlying channel (with a lower index) is indicated in column **Do Conf** on the far right of the graph by a red dot and the orange-colored column.

16	DPCH	No	#8	30	15	0.00	PN 9		0	Config...	On	
17	DPCH	No	#16	960	3	0.00	PN 9		0	Config...	On	
18	DPCH	No	#8	30	17	0.00	PN 9		0	Config...	On	
19	DPCH	No	#8	30	10	0.00	PN 9		0	Config...	On	●
20	DPCH	No	#16	960	0	0.00	PN 9		0	Config...	On	●
21	DPCH	No	#8	30	20	0.00	PN 9		0	Config...	On	●
22	DPCH	No	#8	30	21	0.00	PN 9		0	Config...	On	●

By pressing the red button, a submenu opens which allows automatic resolution of the existing code domain conflicts.



The code domain conflict is resolved by changing the channelization codes of the affected channels. The red dots in column **Co Conf** disappear and the column is blue-colored:

**Note:**

*The HSUPA control channels E-RGCH and E-HICH may use the same channelization code as long as they use different signature sequence hopping index that identifies the user equipment.*

16	DPCH	No	#8	30	79	0.00	PN 9		0	Config...	On	
17	DPCH	No	#16	960	0	0.00	PN 9		0	Config...	On	
18	DPCH	No	#8	30	80	0.00	PN 9		0	Config...	On	
19	DPCH	No	#8	30	81	0.00	PN 9		0	Config...	On	
20	DPCH	No	#16	960	1	0.00	PN 9		0	Config...	On	
21	DPCH	No	#8	30	82	0.00	PN 9		0	Config...	On	
22	DPCH	No	#8	30	83	0.00	PN 9		0	Config...	On	

The graphs immediately display the change:

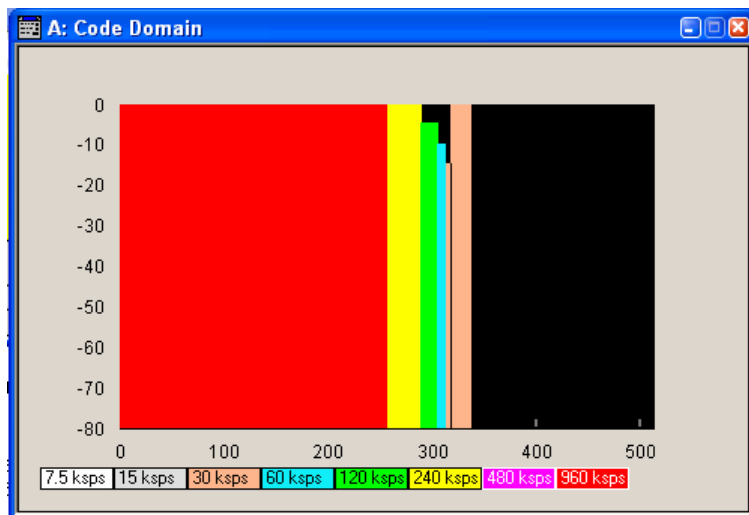



## Channel Graph – Base Station – 3GPP FDD

The channel graph display shows the active code channels. The channel number is plotted on the X axis. The red bars represent the special channels (P-CPICH to DL-DPCCH), the green bars the data channels (DPCH). The height of the bars shows the relative power of the channel.

The graph is calculated from the settings that have been made.

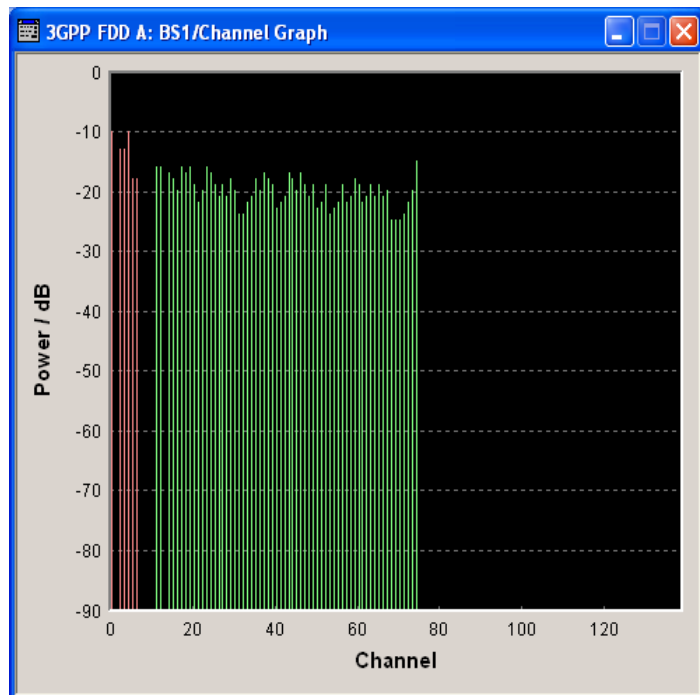

## Channel Table - BS - 3GPP FDD

The **channel table** is located in the lower part of the menu. The channel table is where the individual channel parameters are set. The structure of the channel currently being edited is displayed graphically in the table header.

139 channels are available for each base station. Channels 0 to 10 are assigned to the special channels, with the allocation of channels 0 to 8 being fixed. Channels 9 and 10 can either be assigned a PDSCH, a DL-DPCCH, an HS-SCCH, an E-AGCH, an E-RGCH, or an E\_HICH.

Code channels 11 to 138 can either be assigned a DPCH, an HS-SCCH, an HS-PDSCH (QPSK), an HS-PDSCH (16QAM), an E-AGCH, an R-GCH, an E\_HICH, or an F-DPCH. This makes it possible to simulate the signal of a base station that supports high speed channels.

Channels 4 and 11 to 13 of base station 1 can be generated in realtime (enhanced channels) and are highlighted in colour. User-definable channel coding can be activated for these channels. Bit and block errors can be simulated and data can be added to the data and TPC fields from data lists either at the physical level or in the transport layer.

Data 6		TPC 2		Data 28						Pilot 4		
	Channel Type	Enhanced/HSDPA Settings	Slot Fmt	Symb Rate / ksp/s	Ch Code	Pow / dB	Data	DList / Pattern	T Offs	DPCCH Settings	State	Do Conf
0	P-CPICH			15	0	0.00			0		On	
1	S-CPICH			15	0	0.00			0		Off	
2	P-SCH			15		0.00			0		On	
3	S-SCH			15		0.00			0		On	
4	P-CCPCH	Config...		15	1	0.00	PN 9		0		On	
5	S-CCPCH		#0	15	0	0.00	PN 9		0	Config...	Off	
6	PICH			15	0	0.00	PN 9		0		Off	
7	AICH			15	0	0.00			0		Off	
8	AP-AICH			15	0	0.00			0		Off	
9	PDSCH		#0	15	0	0.00	PN 9		0	Config...	Off	
10	DL-DPCCH		#0	7.5	0	0.00			0	Config...	Off	
11	DPCH	Config...	#14	240	1	0.00	PN 9		0	Config...	On	
12	HS-PDS.16QAM	Config...		240	2	0.00	PN 9		0		On	
13	HS-PDS.16QAM	Config...		240	3	0.00	PN 9		0		On	
14	HS-SCCH	Config...		30	1	0.00	PN 9		0		On	
15	DPCH		#8	30	2	0.00	PN 9		0	Config...	On	

### Channel Number - BS - 3GPP FDD

Displays the consecutive channel numbers from 0 to 138.

All the rows are always displayed, even if the channels are inactive. They are switched on and off by the **On/Off** button in the **State** column.

Remote-control command: n.a.

(selected via the suffix to the keyword :CHANnel<n>)

### Channel Type - BS - 3GPP FDD

Selects channel type.

The channel type is fixed for channel numbers 0...8; for the remaining channel numbers, the choice lies between the relevant standard channels and the high speed channels (see Table below).

The first 11 channels in the table are reserved for special channels.

Remote-control command:

SOUR:BB:W3GP:BST4:CHAN18:TYPE DPCH

Table 4-20 List of supported channel types and their sequence in the 3GPP FDD channel table

Index	Shortform	Name	Function	Optional Enhanced in BS1
0	P-CPICH	Primary Common Pilot Channel	Specifies the scrambling code in the scrambling code group (2 <sup>nd</sup> stage of scrambling code detection) Phase reference for additional downlink channels Reference for the signal strength	no
1	S-CPICH	Secondary Common Pilot Channel		no
2	P-SCH	Primary Sync Channel	Slot synchronization	no
3	S-SCH	Secondary Sync Channel	Frame synchronization Specifies the scrambling code group	no
4	P-CCPCH	Primary Common Control Phys. Channel	Transfers the system frame number (SFN) Timing reference for additional downlink channels Contains the BCH transport channel	yes
5	S-CCPCH	Secondary Common Control Phys. Channel		no
6	PICH	Page Indication Channel	Transfers the paging indicator	no
7	AICH	Acquisition Indication Channel		no
8	AP-AICH	Access Preamble Acquisition Indication Channel		no
9 / 10	PDSCH or DL-DPCCH or HS-SCCH or E-AGCH or E-RGCH or E-HICH	Phys. Downlink Shared Channel Dedicated Physical Control Channel  High Speed Shared Control Channel  E-DCH Absolute Grant Channel  E-DCH Relative Grant Channel  E-DCH Hybrid ARQ Indicator Channel		no
11 - 13	DPCH	Dedicated Phys. Channel	Transfers the user data and the control information	yes
	HS-SCCH	High Speed Shared Control Channel		yes
	HS-PDSCH (QPSK)	High Speed Physical Downlink Shared Channel (QPSK)		yes
	HS-PDSCH (16 QAM)	High Speed Physical Downlink Shared Channel (16 QAM)		yes
	E-AGCH	E-DCH Absolute Grant Channel		no
	E-RGCH	E-DCH Relative Grant Channel		no
	E-HICH	E-DCH Hybrid ARQ Indicator Channel		no
	F-DPCH	Fractional Dedicated Phys. Channel		no
14 - 138	DPCH or HS-SCCH or HS-PDSCH (QPSK) or HS-PDSCH (16 QAM) or E-AGCH or E-RGCH or E-HICH or F-DPCH	Dedicated Phys. Channel High Speed Shared Control Channel  High Speed Physical Downlink Shared Channel (QPSK)  High Speed Physical Downlink Shared Channel (16 QAM)  E-DCH Absolute Grant Channel E-DCH Relative Grant Channel E-DCH Hybrid ARQ Indicator Channel Fractional Dedicated Phys. Channel	Transfers the user data and the control information	no

At the physical level, a downlink DPCH consists of the DPDCH (Dedicated Physical Data Channel) and the DPCCH (Dedicated Physical Control Channel); the channel characteristics are defined by the symbol rate. The DPDCH transports the user data that is fed directly into the data field. The DPCCH transports the control fields (TFCI = Transport Format Combination Indicator; TPC = Transmit Power Control and Pilot field). DPDCH is grouped with DPCCH using time division multiplexing in accordance with 3GPP TS 25.211, see diagram below (the formation of a downlink reference measurement channel is described in Section "[Enhanced settings for DPCHs - BS1 - 3GPP FDD](#)", Page 4.381).

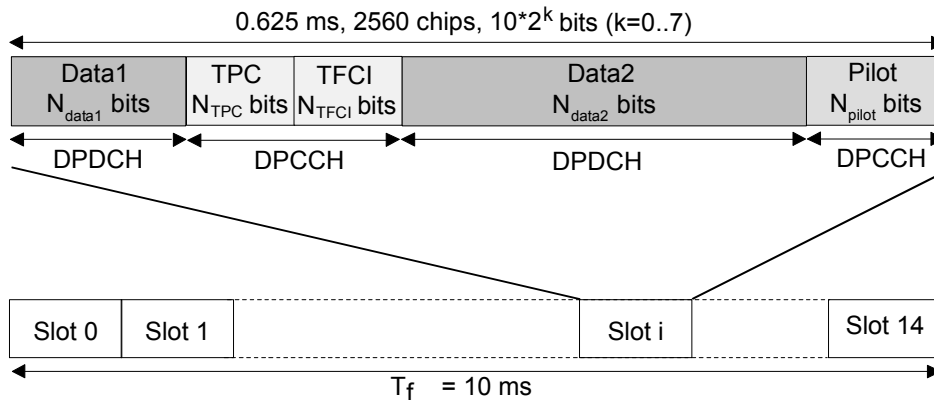

Fig. 4-28 Structure of a downlink DPCH in the time domain

#### Enhanced Settings - BS1 - (This feature is available for BS1 only.) 3GPP FDD

Calls the menu for configuring the enhanced channels of BS1 or the menu for configuring the high speed channels for all base stations.

The channel state, Enhanced On or Off, is displayed in different colors. If the Enhanced state is switched to Off, the ARB channel selection appears in the DATA column of the table.

Enhanced channels are generated in realtime. Channel coding in accordance with the 'Reference Measurement Channels' definition in TS25.101, TS25.104 and TS25.141 can be activated. Any other user-defined codings can also be configured and stored.

If data lists are used as the data sources for data fields and TPC fields, it is possible to load external data, for example, user information from a higher layer, to the R&S Vector Signal Generator. For example, this allows externally generated data with user information to be applied, or TPC lists to be used to generate longer, non-repetitive power profiles.

To test the BER/BLER testers (e.g. integrated in the base station), it is possible to feed through artificial bit errors to all the data sources (and block errors to the CRC checksum).

The menu is different for the P-CCPCH and the DPCHs. The menus are described in Sections "[Enhanced Settings for P-CCPCH - BS1 - 3GPP FDD](#)", Page 4.379, and "[Enhanced settings for DPCHs - BS1 - 3GPP FDD](#)", Page 4.381.

Remote-control command: n.a.

**HSDPA Settings - BS - 3GPP FDD**

Call the menu for configuring the high speed channels.

The available settings and indications of the menu depend on the selected high-speed channel type HS-SCCH, HS-PDSCH (QPSK) or HS-PDSCH (QPSK).

The menu is described in Section "[HSDPA Settings - BS - 3GPP FDD](#)", Page 4.373.

Remote-control command: n . a .

**Slot Format - BS - 3GPP FDD**

Enters the slot formats for the selected channel.

The range of values depends on the channel selected. For DPCH channels, for example, the slot formats are 0 to 16.

A slot format defines the complete structure of a slot made of data and control fields and includes the symbol rate.

Parameters set via the slot format can subsequently be changed individually.

The structure of the channel currently selected is displayed in a graphic above the channel table (slot structure).

Remote-control command:

SOUR:BB:W3GP:BST4:CHAN18:SFOR 7

**Note:**

*For the **DPCCH Settings**, this value is read-only.*

**Symbol Rate - BS - 3GPP FDD**

Sets the symbol rate of the selected channel. The range of values depends on the channel selected.

A change in the symbol rate may lead to a change in the slot format and vice versa.

Remote-control command:

SOUR:BB:W3GP:BST4:CHAN18:SRAT D30K

**Channelization Code - BS - 3GPP FDD**

Enters the channelization code (formerly the spreading code number).

The code channel is spread with the set channelization code (spreading code). The range of values of the channelization code depends on the symbol rate of the channel.

The standard assigns a fixed channelization code to some channels (P-CPICH, for example, always uses channelization code 0).

The range of values runs from 0 to  $\frac{chip\_rate(= 3.84Mcps)}{symbol\_rate} - 1$

Remote-control command:

SOUR:BB:W3GP:BST4:CHAN18:CCOD 0

**Power - BS - 3GPP FDD**

Sets the channel power in dB.

The power entered is relative to the powers outputs of the other channels. If **Adjust Total Power to 0 dB** is executed (top level of the 3GPP menu), all the power data is relative to 0 dB.

The set **Power** value is also the start power of the channel for **Misuse TPC** and **Dynamic Power Control** (enhanced channels of basestation 1).

**Note:**

*The maximum channel power of 0 dB applies to non-blanked channels (duty cycle 100%), with blanked channels, the maximum value can be increased (by Adjust Total Power) to values greater*

*than 0 dB (to  $10 * \log_{10} \frac{1}{duty\_cycle}$ ).*

Remote-control command:

```
SOUR:BB:W3GP:BST4:CHAN18:POW -20
```

**Data - BS - 3GPP FDD**

Selects data source.

The data sources **PN9**, **PN15**, **PN16**, **PN20**, **PN21**, **PN23**, **ALL 0**, **ALL1**, **Pattern**, and **Data List** are all available to choose from.

If the **Pattern** data type is used, you can enter the bit pattern in a bit editor that is called in the column **DList Pattern**. The length is limited to 64 bits.

If the **Data List** data type is used, you can select the list from a file window that is called in the **DList Pattern** column. The selected data list is shown in the **DList Pattern** column.

Remote-control command:

```
SOUR:BB:W3GP:BST3:CHAN13:DATA PATT
SOUR:BB:W3GP:BST3:CHAN13:DATA:PATT #H3F,8
```

```
SOUR:BB:W3GP:BST3:CHAN13:DATA DLIS
SOUR:BB:W3GP:BST3:CHAN13:DATA:DSEL "BST_3GPP"
```

**Data Config - BS - 3GPP FDD**

**(This feature is available for BS1 with active channel coding only.)**

Calls the menu for configuring the data sources of subchannels in the transport layer.

The menu is described in Section "[Enhanced settings for DPCHs - BS1 - 3GPP FDD](#)", Page 4.381.

Remote-control command: n.a.

**Timing Offset - BS - 3GPP FDD**

Sets the timing offset.

The timing offset determines the shift of the source symbols before interleaving.

The absolute starting time of the frame (slot 0) is shifted relative to the start of the scrambling code sequence by the timing offset \* 256 chips. This means that whatever the symbol rate, the resolution of the timing offset is always 256 chips.

This procedure is used to reduce the crest factor. To obtain a lower crest factor, for example, a good offset from channel to channel is 1, that is to say DPCH11 - timing offset 0, DPCH12 - timing offset 1, DPCH13 - timing offset 2, etc.

The illustration below shows the effect of the timing offset parameter. For various scenarios, the scrambling code sequence is shown in time relation to the data slots and to a reference time  $t_0$  (starting from  $t_0$  the signal is calculated in the R&S Vector Signal Generator).

- Timing offset is not used ( $T_{\text{Offset}} = 0$ ). The beginning of the frame (slot 0) and the beginning of the scrambling code period are synchronous with starting point  $t_0$ .
- Timing offset is used ( $T_{\text{Offset}} > 0$ ). The absolute starting time of the frames (slot 0) is shifted relative to the reference time  $t_0$  by  $T_{\text{Offset}} * 256$  chips. The beginning of the scrambling code sequence is still synchronous with reference time  $t_0$ . The beginning of the scrambling code period and the frame (slot 0) are no longer synchronous.

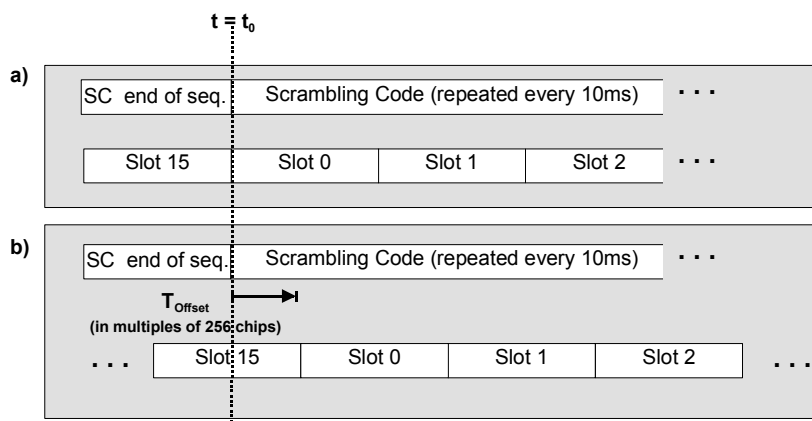

Remote-control command:

SOUR:BB:W3GP:BST3:CHAN13:TOFF 5

**DPCCH Settings- BS - 3GPP FDD**

Calls the menu for configuring the control fields of the selected channel.

The selected slot format predetermines the setting of the control fields. So a change is also made to the control fields by changing the slot format and vice versa.

The menu is described in Section "[DPCCH Settings - BS Channel Table 3GPP FDD](#)", Page 4.397.

Remote-control command: n . a .

**Channel State - BS - 3GPP FDD**

Activates or deactivates the channel.

Remote-control command:

```
SOUR:BB:W3GP:BST3:CHAN13:STAT ON
```

**Domain Conflict - BS - 3GPP FDD**

Displays whether the channel has a code domain conflict with one of the channels lying above it (with a lower channel number). If there is a conflict, a red dot appears and the column is colored soft orange. If there is no conflict, the column is colored soft blue.

The R&S Vector Signal Generator helps to resolve code domain conflicts by automatically adapting the channelization code of the channels involved. You get the button required for this purpose if you click the table field in a submenu.



To call the graphical display of code domain occupancy by all the active code channels, use the **Code Domain** button (also see "[Code Domain Graph – BS – 3GPP FDD](#)", Page 4.362).

You can recognize a domain conflict when the assigned domains of different channel rows overlap. The occupied code domain of a channel is calculated from the symbol rate of the channel, the minimum symbol rate (for 3GPP FDD 7.5 ksps), the chip rate (3.84 Mcps) and the channelization code number with

$$\text{Domain\_Factor} = \frac{\text{current\_symbol\_rate}}{\text{min\_symbol\_rate}(= 7.5\text{ksps})}$$

as follows:

**Lower domain limit =**

current channelization code number \* domain factor

**Upper domain limit =**

lower domain limit + domain\_factor – 1.

**Example:**

Channel with symbol rate 30 ksps and channelization code 10:  
Domain factor = 30/7.5 = 4,

Lower domain limit = 10 x 4 = 40,

Upper domain limit = 40 + 4 - 1 = 43.

The channel occupies the code domain 40 to 43.

Remote-control command:

```
SOUR:BB:W3GP:BST3:DCON:STAT?
```

Response: 1

```
SOUR:BB:W3GP:BST3:DCON:RES
```



## HSDPA Settings - BS - 3GPP FDD

The **HSDPA Settings** menu can be called in the BS channel table in column **HSDPA Settings** with button **Config...**. The available settings and indications of the menu depend on the selected HSDPA mode and channel type.

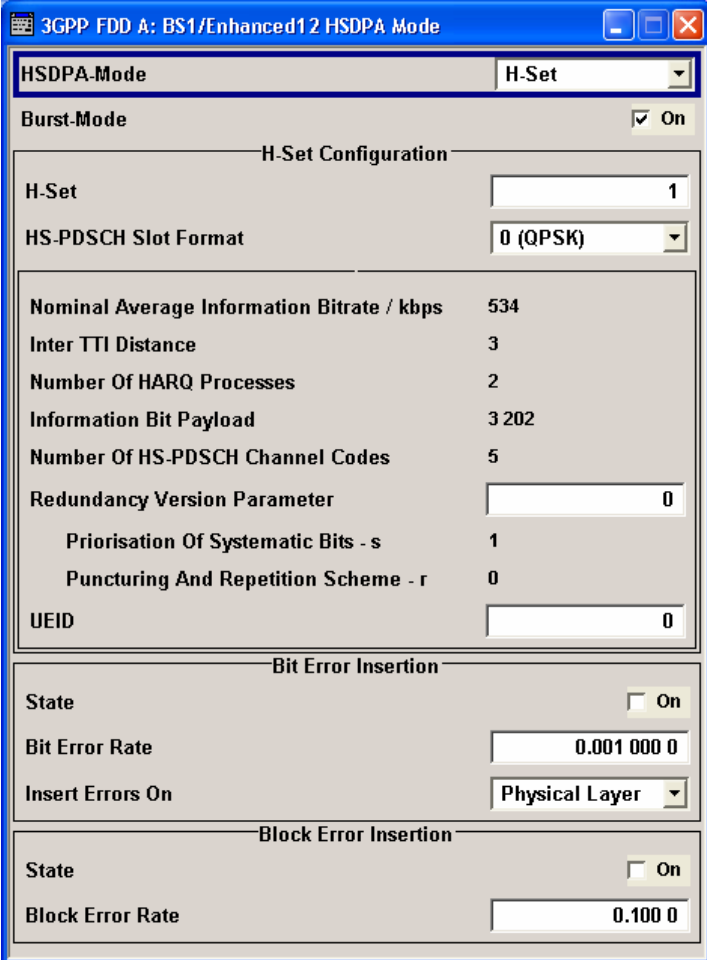

**3GPP FDD A: BS1/Enhanced12 HSDPA Mode**

HSDPA-Mode: H-Set

Burst-Mode:  On

**H-Set Configuration**

H-Set: 1

HS-PDSCH Slot Format: 0 (QPSK)

Nominal Average Information Bitrate / kbps: 534

Inter TTI Distance: 3

Number Of HARQ Processes: 2

Information Bit Payload: 3 202

Number Of HS-PDSCH Channel Codes: 5

Redundancy Version Parameter: 0

Priorisation Of Systematic Bits - s: 1

Puncturing And Repetition Scheme - r: 0

UEID: 0

**Bit Error Insertion**

State:  On

Bit Error Rate: 0.001 000 0

Insert Errors On: Physical Layer

**Block Error Insertion**

State:  On

Block Error Rate: 0.100 0

The high speed channels can be generated either continuously as defined in test model 5, in packet mode or in H-Set mode according to TS 25.141 Annex A.7.

In packet mode, the start of the channel and the distance between the HSDPA packets can be set. The packets can be sent in one of five sub-frames (0 to 4). A sub-frame has the same length as a packet and is 3 slots long. A HS-SCCH starts at the beginning of the selected sub-frame, a HS-PDSCH starts with an offset of two slots to the selected sub-frame.

In packet mode, the graphical display of the slot structure shows one frame (15 slots) with the active part (3 slots = 2 ms). The active parts of the HS-SCCH and the HS-PDSCH for a specific sub-frame setting differ by the slot offset of the HS-PDSCH.

### Example: Setting Sub-frame 1

HS-SCCH: slot 3 to 5 active

HS-PDSCH: slot 7 to 9 active.

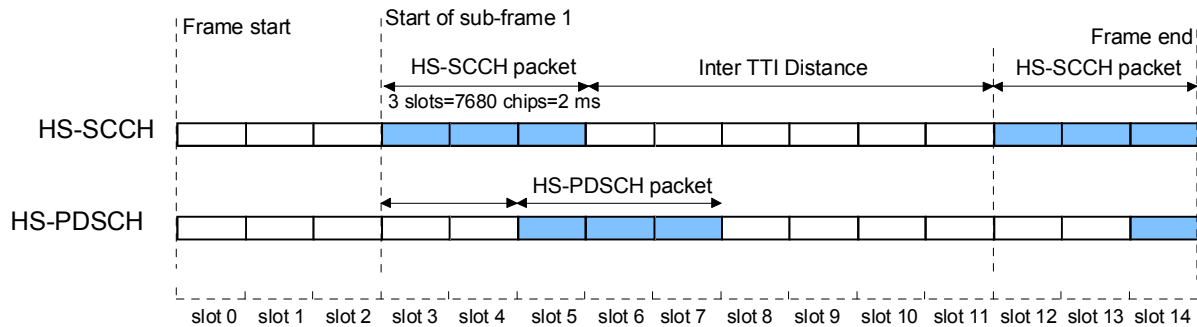

Fig. 4-29 Timing diagram for the HS-SCCH and the associated HS-PDSCH, Packet Subframe 1 mode and Inter TTI Distance = 3

In H-Set mode, the first packet is sent in the HS-SCCH subframe 0. Four or five HSDPA channels are coupled to be used as fixed reference channels. The number of coupled channels depends on the selected HS-PDSCH slot format. Channel coding is always performed over a certain number of bits. The resulting packets are distributed evenly over one subframe of all HS-PDSCH channels. Therefore, the data stream is not assigned to a defined channel but to all coupled channels.

**HSDPA Mode- BS - 3GPP FDD** Selects the HSDPA mode.

**Continuous** The high speed channel is generated continuously. This mode is defined in test model 5.

Remote-control command:

```
SOUR:BB:W3GP:BST2:CHAN15:HSDP:MODE
CONT
```

**Subframe 0 | 1 | 2 | 3 | 4** The high speed channel is generated in packet mode.

The start of the channel is set by selecting the subframe in which the first packet is sent.

The distance between subsequent packets is set with parameter **Inter TTI Distance**.

Remote-control command:

```
SOUR:BB:W3GP:BST2:CHAN15:HSDP:MODE
PSF4
```

**H-Set** **(This feature is available for BS1 and HS-SCCH only.)**

The high speed channel is generated in packet mode. The first packet is sent in the HS-SCCH subframe 0. Five HSDPA channels (channel 12 to channel 17) are coupled to be used as fixed reference channels.

Remote-control command:

```
SOUR:BB:W3GP:BST1:CHAN12:HSDP:MODE
HSET
```

**Inter TTI Distance - BS - 3GPP FDD****(This feature is available for subframe x and H-Set Modes only.)**

Selects the distance between two packets in HSDPA packet mode. The distance is set in number of sub-frames (3 slots = 2 ms). An **Inter TTI Distance** of 1 means continuous generation. For HSDPA-Mode **H-Set**, this field is read-only.

Remote-control command:

SOUR:BB:W3GP:BST2:CHAN15:HSDP:TTID 4

**Burst Mode - BS - 3GPP FDD**

Activates/deactivates burst mode. The signal is bursted when on, otherwise dummy data are sent during transmission brakes.

Remote-control command:

BB:W3GP:BST1:CHAN12:HSDP:BMOD ON

**Constellation Version Parameter b - BS - 3GPP FDD****(This feature is available for HS-PDSCH QAM 16)**

Switches the order of the constellation points of the QAM16 mapping.

The value is indicated and cannot be changed in case of selection HSDPA mode H-Set.

Remote-control command:

SOUR:BB:W3GP:BST1:CHAN12:HSDP:CVPB 1

The input bit sequence is v0,v1,v2,v3.

- |          |   |
|----------|---|
| <b>0</b> | No effect.<br>The output bit sequence is v0,v1,v2,v3.   |
| <b>1</b> | Interchange of MSBs with LSBs.<br>The output bit sequence is v2,v3,v0,v1.                             |
| <b>2</b> | Inversion of LSBs.<br>The output bit sequence is v0,v1,NOTv2,NOTv3.                                   |
| <b>3</b> | Interchange of MSBs with LSBs and inversion of LSBs.<br>The output bit sequence is v2,v3,NOTv0,NOTv1. |

The following settings are only available when **HSDPA Mode H-set** is selected.

**H-Set - BS - 3GPP FDD****(This feature is available for BS1 and HSDPA H-Set Mode only.)**

Selects the H-Set according to TS 25.1401 Annex A.7.

Remote-control command:

BB:W3GP:BST1:CHAN12:HSDP:HSET 3

- H-PDSCH Slot Format - BS - 3GPP FDD** (This feature is available for BS1 and HSDPA H-Set Mode only.)  
Selects the slot format for HS-PDSCH. Slot format 1 corresponds to QPSK and slot format 2 to 16QAM. The number of preset channels depends on the select slot format: Five channels are preset with selection 0 (QPSK) and four channels are preset with selection 1 (16QAM).  
Remote-control command:  
BB:W3GP:BST1:CHAN12:HSDP:SFOR 0
- Nominal Average Information Bitrate - BS - 3GPP FDD** (This feature is available for BS1 and HSDPA H-Set Mode only.)  
Indicates the average data rate on the transport layer.  
Remote-control command:  
BB:W3GP:BST1:CHAN12:HSDP:NAIB?
- Number of HARQ Processes - BS - 3GPP FDD** (This feature is available for BS1 and HSDPA H-Set Mode only.)  
Indicates the number of HARQ processes. This value determines the distribution of the payload in the subframes.  
Remote-control command:  
BB:W3GP:BST1:CHAN12:HSDP:HARQ:LENG?
- Information Bit Payload - BS - 3GPP FDD** (This feature is available for BS1 and HSDPA H-Set Mode only.)  
Indicates the payload of the information bit. This value determines the number of transport layer bits sent in each subframe.  
Remote-control command:  
BB:W3GP:BST1:CHAN12:HSDP:BPAY?
- Number of HS-PDSCH Channel Codes - BS - 3GPP FDD** (This feature is available for BS1 and HSDPA H-Set Mode only.)  
Indicates the number of physical HS-PDSCH data channels assigned to the HS-SCCH.  
Remote-control command:  
BB:W3GP:BST1:CHAN12:HSDP:CLEN?
- Redundancy Version Parameter - BS - 3GPP FDD** (This feature is available for BS1 and HSDPA H-Set Mode only.)  
Enters the Redundancy Version Parameter. This value determines the processing of the Forward Error Correction and Constellation Arrangement (QAM16 modulation), see TS 25.212 4.6.2.  
Remote-control command:  
BB:W3GP:BST1:CHAN12:HSDP:RVP 5

**Priorisation of Systematic Bits - BS - 3GPP FDD**

**(This feature is available for BS1 and HSDPA H-Set Mode only.)**

Indicates processing mode of the data bits (depending on the selected Redundancy Version Parameter).

Remote-control command:  
BB:W3GP:BST1:CHAN12:HSDP:PSBS?

**Puncturing and Repetition Scheme - BS - 3GPP FDD**

**(This feature is available for BS1 and HSDPA H-Set Mode only.)**

Indicates rate matching mode (depending on the selected Redundancy Version Parameter).

Remote-control command:  
BB:W3GP:BST1:CHAN12:HSDP:PRSR?

**UEID - BS - 3GPP FDD**

**(This feature is available for BS1 and HSDPA H-Set Mode only.)**

Enters the UE identity which is the HS-DSCH Radio Network Identifier (H-RNTI) defined in 3GPP TS 25.331: "Radio Resource Control (RRC); Protocol Specification".

Remote-control command:  
BB:W3GP:BST1:CHAN12:HSDP:UEID

**Error Insertion - HSDPA H-Set BS1 - 3GPP FDD**

In the **Bit Error Insertion** and **Block Error Insertion** sections, errors can be inserted into the data source and into the CRC checksum, in order, for example, to check the bit and block error rate testers.

**Bit Error State - HSDPA H-Set BS1 - 3GPP FDD**

Activates or deactivates bit error generation.

Bit errors are inserted into the data stream of the coupled HS-PDSCHs. It is possible to select the layer in which the errors are inserted (physical or transport layer).

When the data source is read out, individual bits are deliberately inverted at random points in the data bit stream at the specified error rate in order to simulate an invalid signal.

Remote-control command:  
SOUR:BB:W3GP:BST:ENH:CHAN12:HSDP:DERR:BIT:STAT ON

**Bit Error Rate TCH -  
HSDPA H-Set BS1 - 3GPP  
FDD**

Sets the bit error rate.

Remote-control command:

```
SOUR:BB:W3GP:BST:ENH:CHAN12:HSDP:DERR:BIT:RATE 1E-3
```

**Insert Errors On - HSDPA  
H-Set BS1 - 3GPP FDD**

Selects the layer at which bit errors are inserted.

**Transport layer**

Bit errors are inserted in the transport layer.

Remote-control command:

```
SOUR:BB:W3GP:ENH:CHAN12:HSDP:DERR:BIT  
:LAY TRAN
```

**Physical layer**

Bit errors are inserted in the physical layer.

Remote-control commands:

```
SOUR:BB:W3GP:BST:ENH:CHAN12:HSDP:DERR  
:BIT:LAY PHYS
```

**Block Error State - HSDPA  
H-Set BS1 - 3GPP FDD**

Activates or deactivates block error generation.

The CRC checksum is determined and then the last bit is inverted at the specified error probability in order to simulate an invalid signal.

Remote-control command:

```
SOUR:BB:W3GP:BST:ENH:CHAN12:HSDP:DERR:BLOC:STAT ON
```

**Block Error Rate - HSDPA  
H-Set BS1 - 3GPP FDD**

Sets the block error rate.

Remote-control command:

```
SOUR:BB:W3GP:BST:ENH:CHAN12:HSDP:DERR:BLOC:RATE 1E-  
3
```

## Enhanced Settings for P-CCPCH - BS1 - 3GPP FDD

The **Enhanced Settings** menu can be called in the BS channel table in column **Enhanced Settings** with button **Config...**

**This menu is only available for base station 1.**

The settings for the enhanced P-CCPCH channel and the enhanced DPCH channels are different (see Section "*Enhanced settings for DPCHs - BS1 - 3GPP FDD*", Page 4.381). The menu for the enhanced P-CCPCH channel (channel 4) is described below.

The upper section is where the selected channel is displayed and where the enhanced state of this channel can be activated.

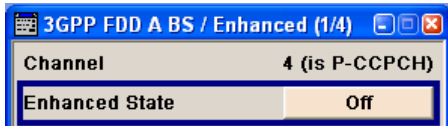

The **Channel Coding** section is where the channel coding settings are made. Interleaver states 1 and 2 can be activated separately.

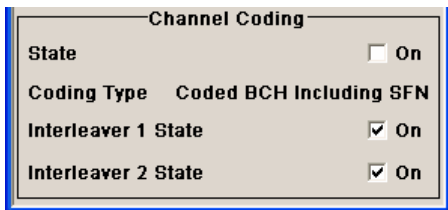

**Channel Number - Enhanced P-CCPCH BS1 - 3GPP FDD**

Displays the channel number and the channel type.  
Remote-control command: n.a.  
(the channel is selected by the keyword PCCPch).

**State- Enhanced P-CCPCH BS1 - 3GPP FDD**

Switches the P-CCPCH (Primary Common Control Phys. Channel) to the enhanced state. The channel signal is generated in realtime.  
Remote-control command:  
SOUR:BB:W3GP:BST:ENH:PCCP:STAT ON

# Channel Coding - Enhanced P-CCPCH BS1 - 3GPP FDD

The **Channel Coding** section is where the channel coding settings are made.

The channel-coded P-CCPCH (Broadcast Channel BCH) with System Frame Number is generated according to the following principle.

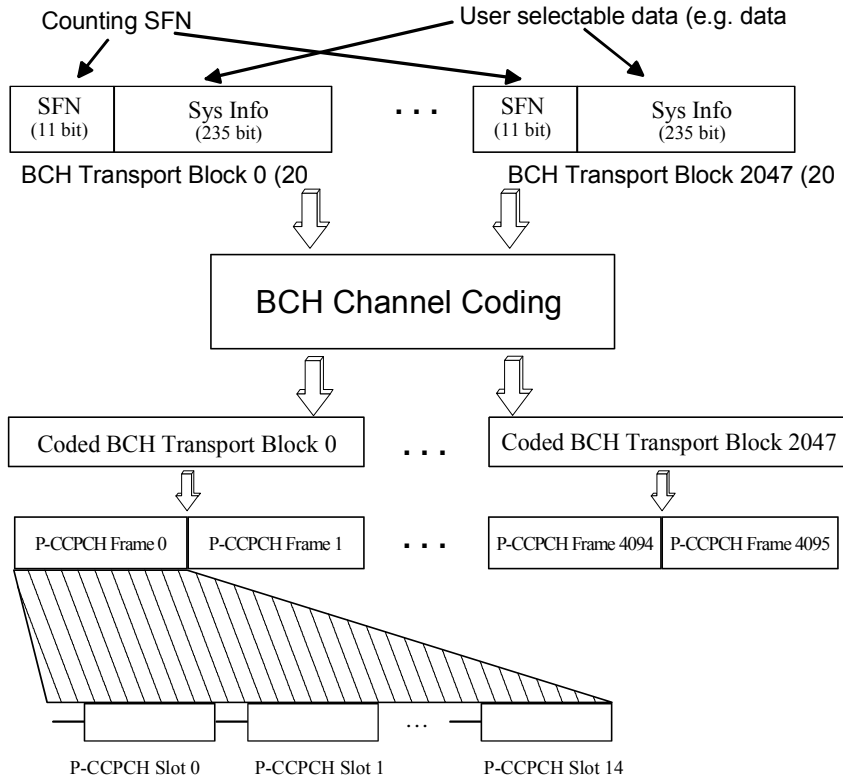

Fig. 4-30 Generation of a channel coded P-CCPCH/BCH

The data blocks of the BCH at transport-channel level comprise data determined for 20 ms of the P-CCPCH (i.e. 2 frames) after channel coding. The first field of such a data block is an 11-bit long field for the system frame number (SFN). The SFN is automatically incremented by 1 (as stipulated in the standard) from transport block to transport block (equivalent to a step width of 2 frames due to the transport time interval length of 20 ms). After 2048 transport blocks (equivalent to 4096 frames) the SFN is reset and starts again at 0 (SFN restart). An output trigger indicating the SFN restart can be generated (see [Trigger/Marker/Clock - 3GPP FDD](#), page 4.337).

The SFN format is defined in the standard; it is MSB-first coded.

The remaining system information (a 235-bit long field per block) is filled from the data source selected for the P-CCPCH.

A data list can be used to transmit further specific system information in addition to the SFN. If only the SFN is required, **ALL 0** is recommended as data source for P-CCPCH.

The BCH transport blocks are then channel-coded. A coded transport block comprises the data sequence for two P-CCPCH frames.



**Channel Coding State - Enhanced P-CCPCH BS1 - 3GPP FDD**

Activates or deactivates channel coding.  
 The coding scheme is displayed in the field below.  
 Remote-control command:  
 SOUR:BB:W3GP:BST:ENH:PCCP:CCOD:STAT ON

**Channel Coding Type - Enhanced P-CCPCH BS1 - 3GPP FDD**

Displays the coding scheme.  
 The coding scheme of P-CCPCH (BCH) is specified in the standard. The channel is generated automatically with the counting system frame number (SFN). The system information after the SFN field is completed from the selected data source.  
 Remote-control command  
 SOUR:BB:W3GP:BST:ENH:PCCP:CCOD:TYPE?  
 Response: BCHS

**Interleaver - Enhanced P-CCPCH BS1 - 3GPP FDD**

Activates or deactivates channel coding interleaver states 1 and 2.

---

**Note:**  
*The interleaver states do not cause the symbol rate to change*

---

Remote-control command:  
 SOUR:BB:W3GP:BST:ENH:PCCP:CCOD:INT1 ON

## Enhanced settings for DPCHs - BS1 - 3GPP FDD

The **Enhanced Settings** menu can be called in the channel table in column **Enhanced/HSDPA Settings** with button **Config...**

**This menu is only available for base station 1.**

The settings for the enhanced P-CCPCH channel (see section above "*Enhanced Settings for P-CCPCH - BS1 - 3GPP FDD*", Page 4.379) and the enhanced DPCH channels are different. The menu for the enhanced DPCH channels (channels 12... 14) is described below. The channels can be set independently.

---

**Note:**  
*For high speed channels, menu HSDPA Settings is called with button **Config...***

---

The upper section is where the selected channel is displayed and where the enhanced state of this channel can be activated.

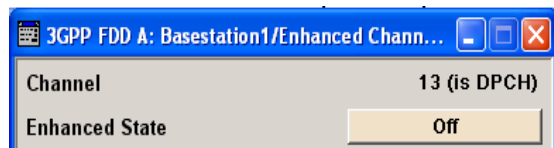

The **Channel Coding** section is where the channel coding settings are made. You can choose between a reduced display, where it is only possible to select the coding scheme, and a display with detailed setting options. The **Transport Channel** section for detailed settings can be revealed with the **Show Details >>>** button and hidden with the **<<< Hide Details** button.

The **Bit Error Insertion** section is where the bit error simulation is configured and activated.

The **Block Error Insertion** section is where the block error simulation is configured and activated.

In the **Dynamic Power Control** section, the power of the selected Enhanced Channel can be increased or decreased within the predefined dynamic range (**Up Range** + **Down Range**) and with the predefined step size (**Power Step**).

#### Channel Number - Enhanced DPCHs BS1 - 3GPP FDD

Displays the number and type of the channel being configured in the enhanced state.

Remote-control command: n.a.

(the channel is selected by the numerical suffix at CHANnel<n> )

#### Channels State - Enhanced DPCHs BS1 - 3GPP FDD

Switches the DPCH channel to the enhanced state.

In the enhanced state, the modulation signal of the selected channel is generated in realtime. It is possible to activate channel coding and simulate bit and block errors. Data lists, for example with user data for the transport layer, can be used as the data source.

Remote-control command:

SOUR:BB:W3GP:BST:ENH:CHAN13:DPCH:STAT ON

## Channel Coding - Enhanced DPCHs BS1 - 3GPP FDD

The **Channel Coding** section is where the channel coding settings are made. You can choose between a reduced display and the detailed setting options display. With the reduced display, it is only possible to select the coding scheme and this selection sets the associated parameters to the presetting prescribed in the standard. The **Transport Channel** section for detailed setting and for defining a user coding can be revealed with the **Show Details >>>** button and hidden with the **<<< Hide Details** button.

A downlink reference measurement channel according to 3GPP TS 25.101 is generated when the transport channels DTCH (Dedicated Traffic Channel) and DCCH (Dedicated Control Channel), which contain the user data, are mapped to a DPCH (Dedicated Physical Channel) with a different data rate after channel coding and multiplexing. The display below is taken from the standard (TS 25.101) and shows in diagrammatic form the generation of a 12.2 kbps reference measurement channel from the DTCH and DCCH transport channels (see standard for figures and tables of other reference measurement channels).

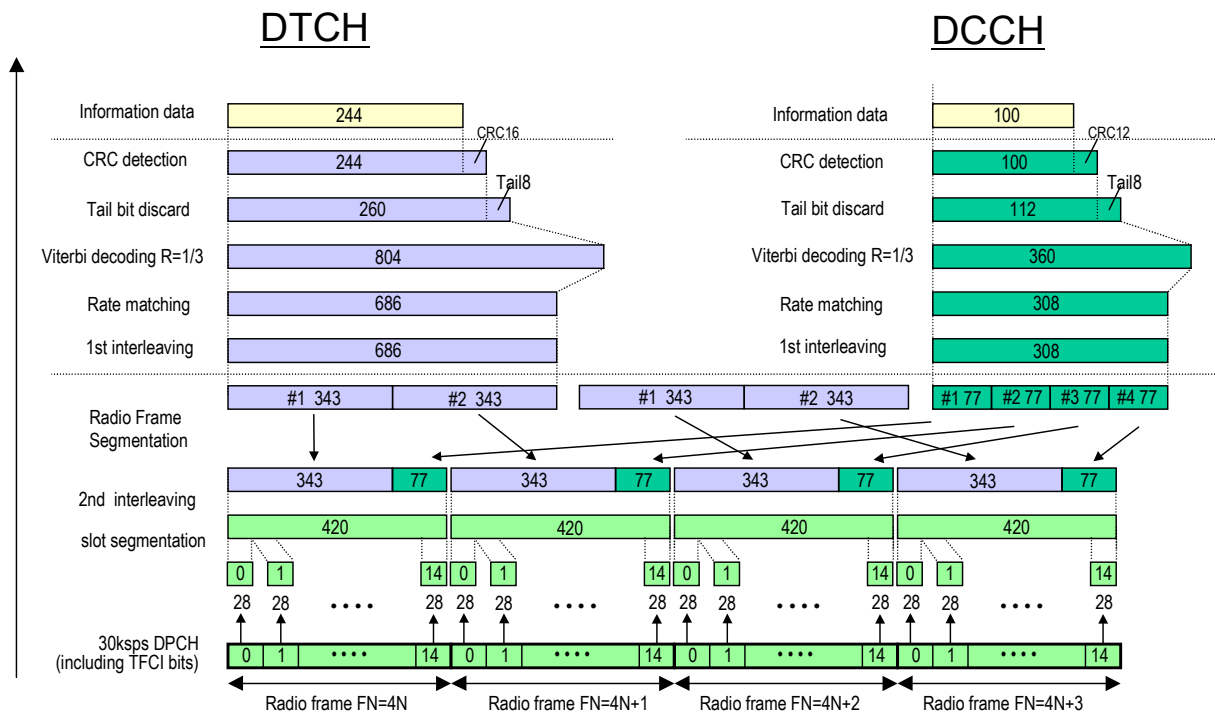

Fig. 4-31 Channel coding of the 12.2 kbps reference measurement channel (downlink)

Table 4-21 The table below shows a summary of the transport channel parameters of the 12.2 kbps reference measurement channel

Parameter	DCCH	DTCH
Data Source	All 0	All 0
Transport Block Size	100	244
Transmission Time Interval	40 ms	20 ms
Type of Error Protection	Convolution Coding	Convolution Coding
Coding Rate	1/3	1/3
Rate Matching attribute	256	256
Size of CRC	12	16
Interleaver 1/2	On	On

**Channel Coding State -  
Enhanced DPCHs BS1 -  
3GPP FDD**

Activates or deactivates channel coding.

Channel-coded measurement channels - so-called "reference measurement channels" - are required for many test procedures specified by the standard.

When channel coding is activated, (depending on the coding type) the slot format (and thus the symbol rate, the pilot length and the TFCI state) are predetermined. The corresponding parameters in the channel table are disabled.

Remote-control command:

SOUR:BB:W3GP:BST1:ENH:CHAN13:DPCH:CCOD:STAT ON

**Channel Coding Type -  
Enhanced DPCHs BS1 -  
3GPP FDD**

Selects channel coding.

The 3GPP specification defines 4 reference measurement channel coding types, which differ in the input data bit rate bit to be processed (12.2, 64, 144 and 384 ksps). The additional AMR CODER coding scheme generates the coding of a voice channel. The BTFD coding types with different data rates are also defined in the 3GPP specification (TS 34.121). They are used for the receiver quality test **Blind Transport Format Detection**. DTX (Discontinuous Transmission) bits are included in the data stream between rate matching and interleaving 1.

**User** codings can be defined as required in the detailed coding settings menu section revealed with button **Show Details >>>**. They can be stored and loaded in the **User Coding...** submenu. Selection **User** is indicated as soon as a coding parameter is modified after selecting a predefined coding type.

The input data bits are taken for channel coding from the data source specified in the **<<< Hide Details** menu section. The bits are available with a higher rate at the channel coding output. The allocations between the measurement input data bit rate and the output symbol rate are fixed, that is to say, the symbol rate is adjusted automatically.

The following are available for selection:

- **RMC 12.2 kbps** 12.2 kbps measurement channel
- **RMC 64 kbps** 64 kbps measurement channel
- **RMC 144 kbps** 144 kbps measurement channel
- **RMC 384 kbps** 384 kbps measurement channel
- **AMR 12.2 kbps** channel coding for the AMR coder
- **BTFD Rate 1 12.2ksps**  
Blind Transport Format Detection Rate 1 (12.2 kbps)
- **BTFD Rate 2 7.95ksps**  
Blind Transport Format Detection Rate 2 (7.95 kbps)
- **BTFD Rate 3 1.95ksps**  
Blind Transport Format Detection Rate 3 (1.95 kbps)

Remote-control command:

SOUR:BB:W3GP:BST:ENH:CHAN13:DPCH:CCOD:TYPE M12K |  
M64K | M144K | M384K | AMR | BTFD1 | BTFD2 | BTFD3

**Show Details... - Enhanced DPCHs BS1 - 3GPP FDD**

Reveals the detailed setting options for channel coding.

Available as well as the **Transport Channel** section are the **Bits per Frame** parameter and the **User Coding** button.

Once the details are revealed, the labelling on the button changes to **<<< Hide Details**. Use this to hide the detailed setting options display again.

Remote-control command: n.a.

<<< Hide Details

User Coding...

Slot Format 10

Symbol Rate 30 ksp/s

Bits per Frame (DPDCH) 450

**Transport Channel**

DTCH 1	DTCH 2	DTCH 3	DTCH 4	DTCH 5	DTCH 6	DCCH
244	100	100	100	100	100	100
PN 9	PN 9	PN 9	PN 9	PN 9	PN 9	PN 9
<input checked="" type="checkbox"/> On	<input type="checkbox"/> On	<input type="checkbox"/> On	<input type="checkbox"/> On	<input type="checkbox"/> On	<input type="checkbox"/> On	<input checked="" type="checkbox"/> On

Data Source PN 9

Transport Time Intervall 20 ms

Transport Blocks 1

Transport Block Size 244

Size Of CRC 16

Rate Matching Attribute 256

DTX Indication Bits 0

Error Protection Conv 1/3

Interleaver 1 State  On

Interleaver 2 State  On

**User Coding ... - Enhanced DPCHs BS1 - 3GPP FDD**

Calls the **User Coding** menu.

From the **User Coding** menu, the **File Select** windows for saving and recalling user-defined channel codings and the **File Manager** can be called.

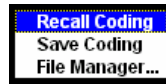

User coding of BST1 are stored as files with the predefined file extension **\*.3g\_ccod\_dl**. The file name and the directory they are stored in are user-definable, the file extension is assigned automatically.

The complete channel coding settings in the menu section **Show Details>>>** are saved and recalled.

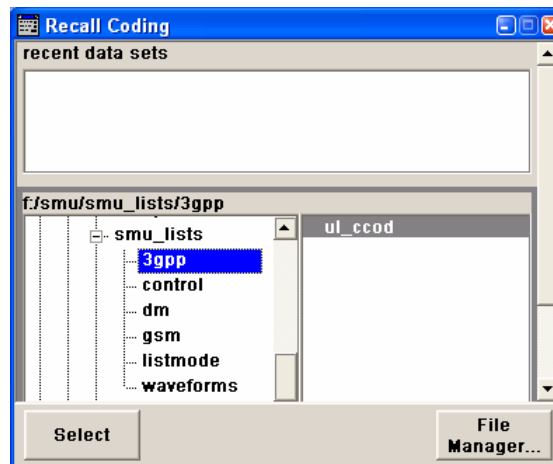

Remote-control command:

```
MMEM:CDIR "f:/gen_lists/3gpp"
SOUR:BB:W3GP:BST:ENH:CHAN13:DPCH:CCOD:USER:CAT?
SOUR:BB:W3GP:BST:ENH:CHAN13:DPCH:CCOD:USER:STOR
'dl_c1'
SOUR:BB:W3GP:BST:ENH:CHAN13:DPCH:CCOD:USER:LOAD
'dl_c1'
```

**Slot Format (DPDCH) - Enhanced DPCHs BS1 - 3GPP FDD**

Enters the slot format. The slot format (and thus the symbol rate, the pilot length and the TFCI state) depends on the coding type selected. The User Coding selection appears as soon as the slot format is changed.

Remote-control command:

```
SOUR:BB:W3GP:BST:ENH:CHAN13:DPCH:CCOD:SFOR?
```

**Symbol Rate (DPDCH) - Enhanced DPCHs BS1 - 3GPP FDD**

Displays the symbol rate.

The symbol rate is determined by the slot format set.

Remote-control command:

```
SOUR:BB:W3GP:BST:ENH:CHAN13:DPCH:CCOD:SRAT?
```

**Bits per Frame (DPDCH) - Enhanced DPCHs BS1 - 3GPP FDD**

Displays the data bits in the DPDCH component of the DPCH frame at physical level. The value depends on the slot format.

Remote-control command:

SOUR:BB:W3GP:BST:ENH:CHAN13:DPCH:CCOD:BPFR?

**Transport Channel - Enhanced DPCHs BS1 - 3GPP FDD**

In the **Transport Channel** section, up to 7 transport channels (TCHs) can be configured. The first one is always a DCCH, the other six are DTCHs (DTCH1 to 6). The most important parameters of the TCH are displayed (data source and transport block size). The associated parameters shown in the section below depend on which TCH is currently selected.

A wide arrow beneath the block indicates which TCH is currently selected.

Transport Channel						
DTCH 1	DTCH 2	DTCH 3	DTCH 4	DTCH 5	DTCH 6	DCCH
244	100	100	100	100	100	100
PN 9	PN 9	PN 9	PN 9	PN 9	PN 9	PN 9
<input checked="" type="checkbox"/> On	<input type="checkbox"/> On	<input type="checkbox"/> On	<input type="checkbox"/> On	<input type="checkbox"/> On	<input type="checkbox"/> On	<input checked="" type="checkbox"/> On
Data Source						PN 9
Transport Time Intervall						20 ms
Transport Blocks						1
Transport Block Size						244
Size Of CRC						16
Rate Matching Attribute						256
DTX Indication Bits						0
Error Protection						Conv 1/3
Interleaver 1 State						<input checked="" type="checkbox"/> On
Interleaver 2 State						<input checked="" type="checkbox"/> On

**Transport Channel State - Enhanced DPCHs BS1 - 3GPP FDD**

Activates or deactivates the transport channel.

Remote-control command:

SOUR:BB:W3GP:BST:ENH:CHAN13:DPCH:TCH3:STAT ON

**Note:**

*In case of remote control, DCCH corresponds to :TCHannel0, DTCH1 to :TCHannel1, etc.*

**Data Source TCH -  
Enhanced DPCHs BS1 -  
3GPP FDD**

Selects the data source for the transport channel.

The following are available for selection as data sources:

**All 0  
All 1**

0 data and 1 data is generated internally.

Remote-control command:

```
SOUR:BB:W3GP:BST:ENH:CHAN13:DPCH:TCH3
:DATA ZERO | ONE
```

**PN xx**

PRBS data as per CCITT with period lengths between  $2^9-1$  and  $2^{23}-1$  is generated internally.

Remote-control commands:

```
SOUR:BB:W3GP:BST:ENH:CHAN13:DPCH:TCH3
:DATA
PN9 | PN11 | PN15 | PN16 | PN20 | PN21 | PN23
```

**Pattern  
Pattern**

A user-definable bit pattern with a maximum length of 64 bits is generated internally.

The bit pattern is defined in the **Pattern** entry field.

Remote-control command:

```
SOUR:BB:W3GP:BST:ENH:CHAN13:DPCH:TCH3
:DATA PATT
SOUR:BB:W3GP:BST:ENH:CHAN13:DPCH:TCH3
:DATA:PATT #H3F,8
```

**Data List  
Select  
Data List**

Internal data from a programmable data list is used. The data list can be generated by the Data Editor or generated externally.

Data lists are selected in the **Select Data List** field.

Remote-control command:

```
SOUR:BB:W3GP:BST:ENH:CHAN13:DPCH:TCH3
:DATA DLIS
SOUR:BB:W3GP:BST:ENH:CHAN13:DPCH:TCH3
:DSEL "dpdc_list1"
```

**Transport Time Interval  
TCH - Enhanced DPCHs  
BS1 - 3GPP FDD**

Sets the number of frames into which a TCH is divided. This setting also defines the interleaver depth.

Remote-control command:

```
SOUR:BB:W3GP:BST:ENH:CHAN13:DPCH:TCH1:TTIN 10 ms
```

**Transport Block Count  
TCH - Enhanced DPCHs  
BS1 - 3GPP FDD**

Sets the number of transport blocks for the TCH.

Remote-control command:

```
SOUR:BB:W3GP:BST:ENH:CHAN13:DPCH:TCH1:TBC 2
```



<b>Transport Block Size TCH - Enhanced DPCHs BS1 - 3GPP FDD</b>	<p>Sets the size of the transport block at the channel coding input.</p> <p>Remote-control command: SOUR:BB:W3GP:BST:ENH:CHAN13:DPCH:TCH1:TBS 244</p>
<b>Size of CRC TCH - Enhanced DPCHs BS1 - 3GPP FDD</b>	<p>Defines the type (length) of the CRC. Checksum determination can also be deactivated (setting <b>None</b>).</p> <p>Remote-control command: SOUR:BB:W3GP:BST:ENH:CHAN13:DPCH:TCH1:CRCS 8</p>
<b>Rate Matching Attribute TCH - Enhanced DPCHs BS1 - 3GPP FDD</b>	<p>Sets data rate matching (Rate Matching).</p> <p>Remote-control command: SOUR:BB:W3GP:BST:ENH:CHAN13:DPCH:TCH1:RMAT 256</p>
<b>DTX Indication Bits TCH - Enhanced DPCHs BS1 - 3GPP FDD</b>	<p>Sets the number of DTX (Discontinuous Transmission) bits. These bits are entered in the data stream between rate matching and interleaver 1. Channel coding of BTFD reference measurement channels Rate 2 and Rate 3 includes DTX267 and DTX644, respectively (see 3GPP TS 34.121).</p> <p>Remote-control command: SOUR:BB:W3GP:BST:ENH:CHAN13:DPCH:TCH1:DTX 257</p>
<b>Error Protection TCH - Enhanced DPCHs BS1 - 3GPP FDD</b>	<p>Selects error protection.</p>
	<p><b>None</b></p> <p>No error protection.</p> <p>Remote-control command: SOUR:BB:W3GP:BST:ENH:CHAN13:DPCH:TCH1 :EPR NONE</p>
	<p><b>Turbo 1/3</b></p> <p>Turbo Coder of rate 1/3 in accordance with the 3GPP specifications.</p> <p>Remote-control commands: SOUR:BB:W3GP:BST:ENH:CHAN13:DPCH:TCH1 :EPR TURB3</p>
	<p><b>Conv 1/2   1/3</b></p> <p>Convolution Coder of rate 1/2 or 1/3 with generator polynomials defined by 3GPP.</p> <p>Remote-control command: SOUR:BB:W3GP:BST:ENH:CHAN13:DPCH:TCH1 :EPR CON2</p>

**Interleaver 1 State TCH - Enhanced DPCHs BS1 - 3GPP FDD**

Activates or deactivates channel coding interleaver state 1 of the transport channel. Interleaver state 1 can be set independently in each TCH. Activation does not change the symbol rate.

Remote-control command:

```
SOUR:BB:W3GP:BST:ENH:CHAN13:DPCH:TCH1:INT ON
```

**Interleaver 2 State TCH - Enhanced DPCHs BS1 - 3GPP FDD**

Activates or deactivates channel coding interleaver state 2 of all the transport channels. Interleaver state 2 can only be set for all the TCHs together. Activation does not change the symbol rate.

Remote-control command:

```
SOUR:BB:W3GP:BST:ENH:CHAN13:DPCH:INT2 O
```

**Error Insertion - Enhanced DPCHs BS1 - 3GPP FDD**

In the **Bit Error Insertion** and **Block Error Insertion** sections, errors can be inserted into the data source and into the CRC checksum, in order, for example, to check the bit and block error rate testers.

Bit Error Insertion	
State	<input type="checkbox"/> On
Bit Error Rate	0.001 000 0
Insert Errors On	Physical Layer
Block Error Insertion	
State	<input type="checkbox"/> On
Block Error Rate	0.100 0

**Bit Error State - Enhanced DPCHs BS1 - 3GPP FDD**

Activates or deactivates bit error generation.

Bit errors are inserted into the data fields of the enhanced channels. When channel coding is active, it is possible to select the layer in which the errors are inserted (physical or transport layer).

When the data source is read out, individual bits are deliberately inverted at random points in the data bit stream at the specified error rate in order to simulate an invalid signal.

Remote-control command:

```
SOUR:BB:W3GP:BST:ENH:CHAN13:DPCH:DERR:BIT:STAT ON
```

**Bit Error Rate - Enhanced DPCHs BS1 - 3GPP FDD**

Sets the bit error rate.

Remote-control command:

```
SOUR:BB:W3GP:BST:ENH:CHAN13:DPCH:DERR:BIT:RATE 1E-3
```

**Insert Errors On -  
Enhanced DPCHs BS1 -  
3GPP FDD**

Selects the layer in the coding process at which bit errors are inserted.

**Transport layer**

Bit errors are inserted in the transport layer.

This selection is only available when channel coding is active.

Remote-control command:

SOUR:BB:W3GP:BST:ENH:CHAN13:DPCH:DERR  
:BIT:LAY TRAN

**Physical layer**

Bit errors are inserted in the physical layer.

Remote-control commands:

SOUR:BB:W3GP:BST:ENH:CHAN13:DPCH:DERR  
:BIT:LAY PHYS

**Block Error State -  
Enhanced DPCHs BS1 -  
3GPP FDD**

Activates or deactivates block error generation.

The CRC checksum is determined and then the last bit is inverted at the specified error probability in order to simulate an invalid signal.

Remote-control command:

SOUR:BB:W3GP:BST:ENH:CHAN13:DPCH:DERR:BLOC:STAT ON

**Block Error Rate -  
Enhanced DPCHs BS1 -  
3GPP FDD**

Sets block error rate.

Remote-control command:

SOUR:BB:W3GP:BST:ENH:CHAN13:DPCH:DERR:BLOC:RATE 1E-  
3

## Dynamic Power Control - Enhanced DPCHs BS1 - 3GPP FDD

In the **Dynamic Power Control** section of menu **Enhanced Settings**, the power of the selected enhanced channel can be increased or decreased within the predefined dynamic range (**Up Range + Down Range**) and with the predefined step size (**Power Step**) with an control signal.

The control signal can be provided either externally (LEV ATT), internally (TPC pattern) or manually (see **Mode** setting).

With **Dynamic Power Control** the test of Closed (Inner) Loop Power Control can be performed in two test constellations:

1. Test whether the DUT (receiver) correctly performs the SIR (Signal to Interference Ratio) measurement and inserts the corresponding bits into the TPC field of its transmit signal. The TPC control information is provided by an external **Dynamic Power Control** signal.
2. Test whether the DUT (transmitter) responds with the correct output power to received TPC bits. This can be carried out by using a data list adapted to the test condition as TPC data source. The TPC pattern can be defined in the channel table.

The power change of the channels is performed by a switchover of the mapping table, controlled by the **Dynamic Power Control** signal which is queried at the beginning of the pilot field. Since the number of mappings is limited, the maximum dynamic range is restricted to 30 dB and the step width to min. 0.5 dB. The output power of each channel is thus limited to the dynamic range around the channel-specific start power.

---

**Note:**

*To obtain optimum signal quality, the **Power Up Range** should not be set higher than necessary since the mapping of the I/Q level in this range must be maintained as a level margin.*

---

**Example:**

Power Up Range = Power Down Range

Mode Up for channel11 and 13

Mode Down for channel 12

The following figure shows the change of channel power of the 3 enhanced channels. The external control signal LEV ATT is used.

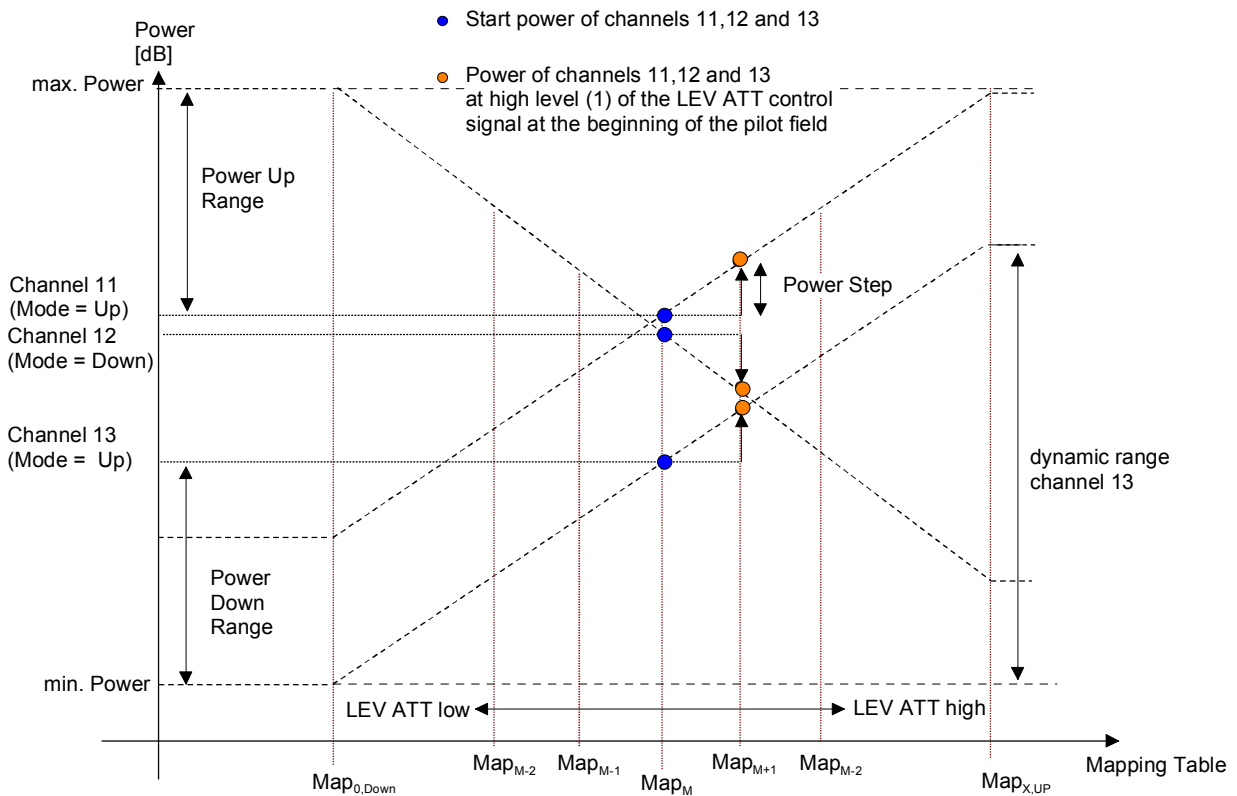

Fig. 4-32 Dynamic Power Control - Down Link

Available mappings are shown on the X-axis with  $MAP_M$  being the starting point. In this point, all channels have the start power which was set in the channel table.

At the beginning of the pilot field the LEVATT line is queried in each timeslot. If this line is set to logical "1" switchover is made to the right mapping  $MAP_{M+1}$ . This means an increase of the output power by **Power Step** for all channels with **Power Control Mode Up**. The power of channel 12 is decreased by the same value (see figure above).

If the LEVATT line is set to logical "0" switchover is made to the left mapping  $MAP_{M-1}$ . This means a reduction of the output power by **Power Step** for all channels with **Power Control Mode Down**. The power of channel 12 is increased by the same value.

The **Dynamic Power Control** settings are performed in the **Enhanced Settings** menu of the channel table.

Dynamic Power Control	
State	<input type="checkbox"/> On
Mode	External
Direction	Up
Power Step	1.00 dB
Up Range	10.00 dB
Down Range	10.00 dB

**Dynamic Power Control  
State - Enhanced DPCHs  
BS1 - 3GPP FDD**

Activates or deactivates the **Dynamic Power Control** for the selected enhanced channel.

Remote-control command:

```
SOUR:BB:W3GP:BST:ENH:CHAN11:DPCH:DPC:STAT ON
```

**Mode - Enhanced DPCHs  
BS1 - 3GPP FDD**

Selects the control signal for **Dynamic Power Control**.

**External**

An external control signal is used for Dynamic Power Control. The external control signal is supplied via the LEV ATT input of the AUX I/O connector (path A) or via one of the USER interfaces (path B).

**Note:**

*Marker 4 must be set to **Slot** mode and the length of the pilot fields of all active DPCHs must be same if Dynamic Power Control with external control signal is active.*

Remote-control command:

```
SOUR:BB:W3GP:BST:ENH:CHAN11:DPCH:DPC:
MODE EXT
```

**TPC**

The TPC pattern is used for Dynamic Power Control. This selection corresponds to selection (Mis)Use TPC for not enhanced DPCHs.

Remote-control command:

```
SOUR:BB:W3GP:BST:ENH:CHAN11:DPCH:DPC:
SOUR TPC
```

**Manual**

The control signal is manually produced by pushing one of the buttons **0** or **1**. Button **1** corresponds to a positive control signal, button **0** to a negative control signal.

The channel power is increased or decreased depending on the **Direction** setting by the set power step .

Remote-control command:

```
SOUR:BB:W3GP:BST:ENH:CHAN11:DPCH:DPC:
MODE MAN
SOUR:BB:W3GP:BST:ENH:CHAN11:DPCH:DPC:
STEP:MAN MAN0 | MAN1
```

**Direction - Enhanced DPCHs BS1 - 3GPP FDD**

Selects the **Dynamic Power Control** direction. The **Direction** setting defines whether the channel power is increased or decreased by a high level of the control signal (see "Dynamic Power Control - Downlink" figure).

**Up**

A high level of the control signal leads to an increase of channel power.

Remote-control command:

```
SOUR:BB:W3GP:BST:ENH:CHAN11:DPCH:DPC:
DIR UP
```

**Down**

A high level of the control signal leads to a decrease of channel power.

Remote-control command:

```
SOUR:BB:W3GP:BST:ENH:CHAN11:DPCH:DPC:
DIR DOWN
```

**Power Step Dyn Power Control - Enhanced DPCHs BS1 - 3GPP FDD**

Sets step width by which – with **Dynamic Power Control** being switched on - the channel power of the selected enhanced channel in the timeslot grid (= 0,667 ms) is increased or decreased within the set dynamic range (**Up Range + Down Range**).

The start power of the channel is set in the Power column of the channel table.

Remote-control command:

```
SOUR:BB:W3GP:BST:ENH:CHAN11:DPCH:DPC:STEP 1
```

**Up Range Dyn Power Control - Enhanced DPCHs BS1 - 3GPP FDD**

Sets dynamic range by which – with **Dynamic Power Control** switched on – the channel power of the selected enhanced channel can be increased. The resulting **Dynamic Power Control** dynamic range (**Up Range + Down Range**) may be 30 dB at max.

Remote-control command:

```
SOUR:BB:W3GP:BST:ENH:CHAN11:DPCH:DPC:RANG:UP 10
```

**Down Range Dyn Power Control - Enhanced DPCHs BS1 - 3GPP FDD**

Sets dynamic range by which – with **Dynamic Power Control** switched on – the channel power of the selected enhanced channel can be decreased. The resulting **Dynamic Power Control** dynamic range (**Up Range + Down Range**) may be 30 dB at max.

Remote-control command:

```
SOUR:BB:W3GP:BST:ENH:CHAN11:DPCH:DPC:RANG:DOWN 10
```

**Power Control Graph -  
Enhanced DPCHs BS1 -  
3GPP FDD**

Indicates the deviation of the channel power ( $\Delta$ POW) from the set power start value of the corresponding enhanced channels.

The graph is automatically displayed with **Dynamic Power Control** switched on.

**Note:**

*Since a realtime update of the window in the timeslot (= 0.667 ms) is not possible for reasons of speed, an update can be performed in a more coarse time interval. Fast channel power changes are not displayed but the settled state of the control loop can be recognized very easily.*

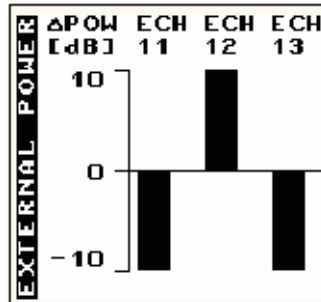

Remote-control command:

SOUR:BB:W3GP:BST:ENH:CHAN11:DPCH:DPC:POW?



## DPCCH Settings - BS Channel Table 3GPP FDD

The **Config DPCCH** menu for configuring the fields of the dedicated physical control channel can be called in the channel table in column **DPCCH SETT** with the **Config...** button.

**This menu is only available for selected channel types.**

The selected slot format predetermines the setting of the parameters provided in the menu. Whenever the TFCI State and Pilot Length settings are changed, the slot format is adjusted accordingly. Pilot Length and TFCI State can be selected for the S-CCPCH channel.

The upper section of the menu is where the slot structure is displayed and the TFCI and Pilot control fields are set.

Data	TPC	Data	Pilot
6	2	28	4

Slot Format: 8

TFCI:  Use

TFCI: 0

Pilot Length: 4 Bit

Multi Code State:  On

The **TPC Settings** section is where the TPC field is set.

TPC Settings

TPC Source: All 0

Read Out Mode: Continuous

TPC For Output Power Control:  (Mis-)Use

Power Step: 0.00 dB

The **DPCCH Power Offset** section is where the power offset of the control fields to the set channel power is set.

DPCCH Power Offset

Power Offset Pilot: 0.00 dB

Power Offset TPC: 0.00 dB

Power Offset TFCI: 0.00 dB

### Slot Structure (DPCCH) - BS - 3GPP FDD

Data	TPC	Data	Pilot
6	2	28	4

Displays the slot structure.

The structure of the slot depends on the slot format selected (see also 3GPP TS 25.211, Table 11: DPDCH and DPCCH fields)

Remote-control command: n . a .

**Slot Format (DPCCH) - BS - 3GPP FDD** Displays the slot format.  
 The slot format displayed changes when a change is made to the TFCI and Pilot control field settings.  
 Remote-control command:n.a.

**TFCI State (DPCCH) - BS - 3GPP FDD** Activates TFCI field usage.

**Note:**

*The remote-control command is not valid for multichannel mode.*

Remote-control command:

SOUR:BB:W3GP:BST1:CHAN13:DPCC:TFCI:STAT ON

**TFCI Value (DPCCH) - BS - 3GPP FDD** Enters the value of the TFCI field (Transport Format Combination Indicator) . This value is used to select a combination of 30 bits, which is divided into two groups of 15 successive slots.

Remote-control command:

SOUR:BB:W3GP:BST1:CHAN13:DPCC:TFCI 2

**Pilot Length (DPCCH) - BS - 3GPP FDD** Sets the length of the pilot fields.

The range of values for this parameter depends on the channel type and the symbol rate.

To achieve a constant slot length, the data fields are lengthened or shortened depending on the pilot length, as defined in the standard.

**Notes:**

*The pilot fields of all active DPCHs must be of the same length if Dynamic Power Control with external control signal is active.*

Remote-control command:

SOUR:BB:W3GP:BST1:CHAN13:DPCC:PLEN BIT2

**Multicode State (DPCCH) - BS - 3GPP FDD** Activates multicode transmission.

Multicode transmission can be activated for a group of channels destined for the same receiver, that is to say, belonging to a radio link. The first channel of this group is used as the master channel.

With multicode transmission, the common components (Pilot, TPC and TCFI) for all the channels are spread using the spreading code of the master channel.

This parameter is only available for the DPCHs.

Remote-control command:

SOUR:BB:W3GP:BST1:CHAN13:DPCC:MCOD ON

SOUR:BB:W3GP:BST1:CHAN14:DPCC:MCOD ON

SOUR:BB:W3GP:BST1:CHAN15:DPCC:MCOD ON

### TPC Data Source (DPCCH) - BS - 3GPP FDD

The **TPC Settings** section is where the settings for the TPC field (Transmit Power Control) are made. This field is used to control the transmit power.

When **Pattern** is selected, an entry field appears for the bit pattern. The maximum bit pattern length is 64 bits.

TPC Pattern	0
Read Out Mod	

When **Data List** is selected, a button appears for calling the **File Select** window.

Select TPC List...	None
--------------------	------

Remote-control command:

```
SOUR:BB:W3GP:BST2:CHAN13:DPCC:TPC:DATA ZERO | ONE
```

```
SOUR:BB:W3GP:BST2:CHAN13:DPCC:TPC:DATA PATT
SOUR:BB:W3GP:BST2:CHAN13:DPCC:TPC:DATA:PATT #H3F,8
```

```
SOUR:BB:W3GP:BST2:CHAN13:DPCC:TPC:DATA DLIS
SOUR:BB:W3GP:BST2:CHAN13:DPCC:TPC:DATA:DSEL
"tpc_bts"
```

### TPC Read Out Mode (DPCCH) - BS - 3GPP FDD

Defines TPC data usage.

With 3GPP, the TPC bits are used to signal the increase or reduction in transmit power to the called station. With all read out modes, one bit is taken from the data stream for the TPC field for each slot and entered into the bit stream several times (depending on the symbol rate). The difference between the modes lies in the usage of the TPC bits.

These different modes can be used, for example, to deliberately set a base station to a specific output power (e.g. with the pattern 11111) and then let it oscillate around this power (with Single + alt. 01 and Single + alt. 10). This then allows power measurements to be carried out at the base station (at a quasi-constant power). Together with the option (Mis-)Use TPC for output power control (see below), TPC Read Out Mode can also be used to generate various output power profiles.

**Continuous:** The TPC bits are used cyclically.

Remote-control command:

```
SOUR:BB:W3GP:BST2:CHAN13:DPCC:TPC:REA
D CONT
```

**Single + All 0** The TPC bits are used once, and then the TPC sequence is continued with 0 bits.

Remote-control commands:

```
SOUR:BB:W3GP:BST2:CHAN13:DPCC:TPC:REA
D S0A
```

- Single + All 1** The TPC bits are used once, and then the TPC sequence is continued with 1 bits.
- Remote-control command:  
SOUR:BB:W3GP:BST2:CHAN13:DPCC:TPC:READ S1A
- Single + alt. 01** The TPC bits are used once and then the TPC sequence is continued with 0 and 1 bits alternately (in multiples, depending on by the symbol rate, for example, 00001111).
- Remote-control command:  
SOUR:BB:W3GP:BST2:CHAN13:DPCC:TPC:READ S01A
- Single + alt. 10** The TPC bits are used once and then the TPC sequence is continued with 1 and 0 bits alternately (in multiples, depending on by the symbol rate, for example, 11110000).
- Remote-control command:  
SOUR:BB:W3GP:BST:DPCC:CHAN13:TPC:READ S10A

### Misuse TPC for Output Power Control (DPCCH) - BS - 3GPP FDD

Defines "mis-" use of the TPC data.

With 3GPP, the TPC bits are used to signal the increase or reduction in transmit power to the called station. If **(Mis-) use TPC for output power control** is activated, the specified pattern is misused, in order to vary the intrinsic transmit power over time. A bit of this pattern is removed for each slot in order to increase (bit = "1") or reduce (bit = "0") the channel power by the specified power step (**Power Step**). The upper limit for this is 0 dB and the lower limit -80 dB. The following envelope is produced at a channel power of 0 dB, power step 1.0 dB and pattern "001110100000011" and TPC Pattern ReadOut Mode **Continuous**:

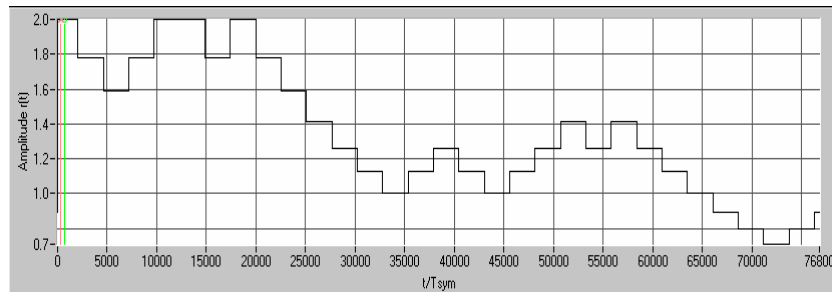

Fig. 4-33 Dynamic change of channel power (continuous)

#### Notes:

*The change in power is always carried out (as stipulated in the standard) at the start of the slot pilot field.*

*Misuse TPC for Output Power Control is not available for enhanced DPCHs. Power Control via TPC pattern for enhanced channels can be selected for active Dynamic Power Control (see "Dynamic Power Control - Enhanced DPCHs BS1 - 3GPP FDD", page 4.392).*

*The remote-control command is not valid for multichannel mode.*

Remote-control command:

```
SOUR:BB:W3GP:BST2:CHAN13:DPCC:TPC:MIS ON
```

### TPC Power Step (DPCCH) - BS - 3GPP FDD

Sets the step width of the power change in dB for **(Mis-) use TPC for output power control**.

#### Note:

*Misuse TPC for Output Power Control is not available for enhanced DPCHs. Power Control via TPC pattern for enhanced channels can be selected for active Dynamic Power Control (see "Dynamic Power Control - Enhanced DPCHs BS1 - 3GPP FDD", page 4.392).*

Remote-control command:

```
SOUR:BB:W3GP:BST2:CHAN13:DPCC:TPC:PST 1.0
```

The **DPCCH Power Offset** section is where the power offset of the control fields to the set channel power is set.

**Power Offset Pilot (DPCCH) - BS - 3GPP FDD** Sets the power offset of the pilot field to the channel power in dB.

Remote-control command:  
SOUR:BB:W3GP:BST2:CHAN13:DPCC:POFF:PIL 1

**Power Offset TPC (DPCCH) - BS - 3GPP FDD** Sets the power offset of the TPC field to the channel power in dB.

Remote-control command:  
SOUR:BB:W3GP:BST2:CHAN13:DPCC:POFF:TPC 1

**Power Offset TFCI (DPCCH) - BS - 3GPP FDD** Sets the power offset of the TFCI field to the channel power in dB.

Remote-control command:  
SOUR:BB:W3GP:BST2:CHAN13:DPCC:POFF:TFCI 1

## Config F-DPCH - BS Channel Table 3GPP FDD

The **Config F-DPCCH** menu for configuring the fields of the fractional dedicated physical control channel can be called in the channel table in column **DPCCH SETT** with the **Config...** button.

**This menu is only available for selected channel types.**

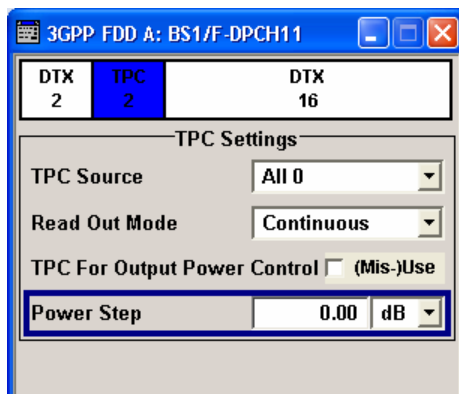

### Slot Structure (F-DPCH) - BS - 3GPP FDD

DTX	TPC	DTX
2	2	16

Displays the slot structure.

The structure of the slot depends on the slot format selected.

Remote-control command: n . a .

**TPC Source – F-DPCH - 3GPP FDD**

Selects the data source for the F-DPCH channel.  
The following data sources are available for selection

- All 0**                    0 data and 1 data is generated internally.
- All 1**                    Remote-control command:  
SOUR:BB:W3GP:BST1:CHAN11:FDPC:DPCC:TP  
C:DATA ZERO

**Pattern**                    A user-definable bit pattern with a maximum length of 64 bits is generated internally.  
  
The bit pattern is defined in the **Data Pattern** entry field.

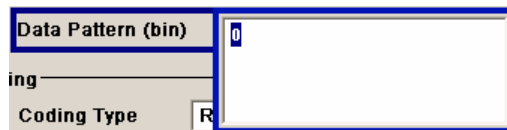

Remote-control command:  
SOUR:BB:W3GP:BST1:CHAN11:FDPC:DPCC:TP  
C:DATA PATT  
SOUR:BB:W3GP:BST1:CHAN11:FDPC:DPCC:TP  
C:DATA PATT #H0,1

**Data List**                    Internal data from a programmable data list generated with the Data Editor or externally, is used.

Data lists are selected in the **File Select** window, which is called by means of the **Select Data List** button.



The **File Manager** is used to transmit external data lists to the R&S Vector Signal Generator, and can be called within every **File Select** window by means of the **File Manager** button.

Remote-control command:  
SOUR:BB:W3GP:BST1:CHAN11:FDPC:DPCC:TP  
C:DATA DLIS  
SOUR:BB:W3GP:BST1:CHAN11:FDPC:DPCC:TP  
C:DATA: DSEL "tpc\_bts"

**TPC Read Out Mode (F-DPCH) - BS - 3GPP FDD**

Defines TPC data usage.

With 3GPP, the TPC bits are used to signal the increase or reduction in transmit power to the called station. With all read out modes, one bit is taken from the data stream for the TPC field for each slot and entered into the bit stream several times (depending on the symbol rate). The difference between the modes lies in the usage of the TPC bits.

These different modes can be used, for example, to deliberately set a base station to a specific output power (e.g. with the pattern 11111) and then let it oscillate around this power (with Single + alt. 01 and Single + alt. 10). This then allows power measurements to be carried out at the base station (at a quasi-constant power). Together with the option (Mis-)Use TPC for output power control (see below), TPC Read Out Mode can also be used to generate various output power profiles.

**Continuous:** The TPC bits are used cyclically.

Remote-control command

```
SOUR:BB:W3GP:BST1:CHAN11:FDPC:DPCC:TP
C:READ CONT
```

**Single + All 0** The TPC bits are used once, and then the TPC sequence is continued with 0 bits.

Remote-control commands:

```
SOUR:BB:W3GP:BST1:CHAN11:FDPC:DPCC:TP
C:READ S0A
```

**Single + All 1** The TPC bits are used once, and then the TPC sequence is continued with 1 bits.

Remote-control command:

```
SOUR:BB:W3GP:BST1:CHAN11:FDPC:DPCC:TP
C:READ S1A
```

**Single + alt. 01** The TPC bits are used once and then the TPC sequence is continued with 0 and 1 bits alternately (in multiples, depending on by the symbol rate, for example, 00001111).

Remote-control command:

```
SOUR:BB:W3GP:BST1:CHAN11:FDPC:DPCC:TP
C:READ S01A
```

**Single + alt. 10** The TPC bits are used once and then the TPC sequence is continued with 1 and 0 bits alternately (in multiples, depending on by the symbol rate, for example, 11110000).

Remote-control command:

```
SOUR:BB:W3GP:BST1:CHAN11:FDPC:DPCC:TP
C:READ S10A
```



### TPC For Output Power Control (Mis-) Use (F-DPCH) - BS - 3GPP FDD

Defines "mis-" use of the TPC data.

With 3GPP, the TPC bits are used to signal the increase or reduction in transmit power to the called station. If **(Mis-) use TPC for output power control** is activated, the specified pattern is misused, in order to vary the intrinsic transmit power over time. A bit of this pattern is removed for each slot in order to increase (bit = "1") or reduce (bit = "0") the channel power by the specified power step (**Power Step**). The upper limit for this is 0 dB and the lower limit -80 dB. The following envelope is produced at a channel power of 0 dB, power step 1.0 dB and pattern "001110100000011" and TPC Pattern ReadOut Mode **Continuous**:

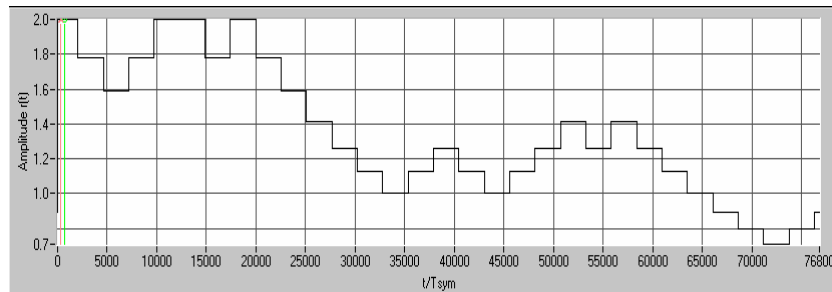

Fig. 4-34 Dynamic change of channel power (continuous)

Remote-control command:

```
SOUR:BB:W3GP:BST1:CHAN11:FDPC:DPCC:TPC:MIS ON
```

### TPC Power Step (F-DPCH) - BS - 3GPP FDD

Sets the step width of the power change in dB for **(Mis-) use TPC for output power control**.

Remote-control command:

```
SOUR:BB:W3GP:BST1:CHAN11:FDPC:DPCC:TPC:PST 1.5dB
```

## Config AICH or AP-AICH - BS Channel Table 3GPP FDD

The **Config AICH** or **Config AP-AICH** menu for configuring the fields of the dedicated physical control channel can be called in the channel table in column **DPCCH SETT** with the **Config...** button.

### Signature ACK/NACK Pattern - BS - 3GPP FDD

Enters the 16 bit pattern for the ACK/NACK field. This field is used by the base station to acknowledge, refuse or ignore requests of up to 16 user equipments.

---

**Note:**

*Pattern + is entered using the numeric key 1. Pattern - is entered via the numeric key +/-.*

---

Remote-control command: n.a.

SOUR:BB:W3GP:BST1:CHAN7:AICH:SAP "+00000000000000"

SOUR:BB:W3GP:BST1:CHAN8:APAI:SAP "+00000000000000"

**"+" = ACK**

The ACK is sent. Transmission was successful and correct.

**"-" = NACK**

The NACK is not sent. Transmission was not correct.

**"0" = DTX**

Nothing is sent. Transmission is interrupted (Discontinuous Transmission (DTX)).

### Access Slot - BS - 3GPP FDD

Selects the slot in which the burst is transmitted.

Remote-control command:

SOUR:BB:W3GP:BST1:CHAN7:AICH:ASLO 2

SOUR:BB:W3GP:BST1:CHAN7:APAI:ASLO 2

## Config E-RGCH – E-HICH - BS Channel Table 3GPP FDD

The **Config E-RGCH** or **Config E-HICH** menu for configuring the fields of the HSUPA control channels can be called in the channel table in column **DPCCH SETT** with the **Config...** button.

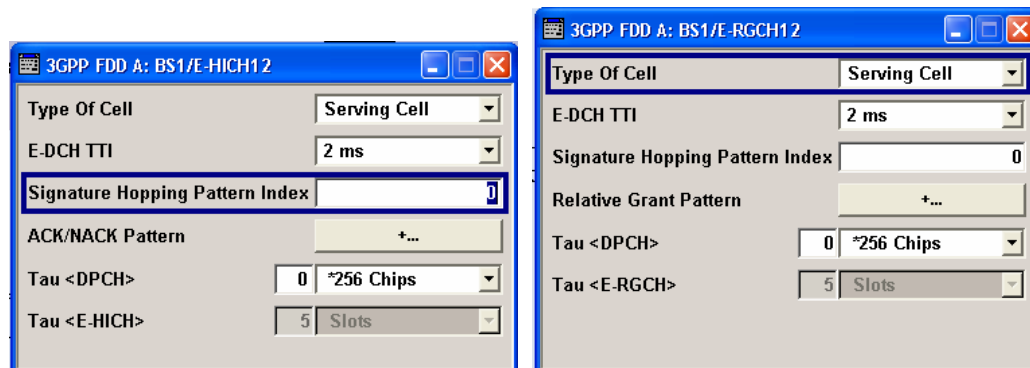

**Type of Cell – HSUPA BS - 3GPP** Switches between Serving Cell and Non Serving Cell. The cell type determines the number of used slots.

Remote-control command:

```
SOUR:BB:W3GP:BST1:CHAN9:HSUP:ERGC:CTYP SERV
SOUR:BB:W3GP:BST1:CHAN10:HSUP:EHIC:CTYP SERV
```

**E-DCH TTI – HSUPA BS - 3GPP FDD** Switches between 2 ms and 10 ms. The processing duration also influences the number of used slots. Remote-control command:

```
SOUR:BB:W3GP:BST1:CHAN9:HSUP:ERGC:TTIE 2ms
SOUR:BB:W3GP:BST1:CHAN10:HSUP:EHIC:TTIE 2ms
```

**Signature Sequence Index – HSUPA BS - 3GPP FDD** Enters a value that identifies the user equipment. The values are defined in TS 25.211.

Remote-control command:

```
SOUR:BB:W3GP:BST1:CHAN9:HSUP:ERGC:SSIN 0
SOUR:BB:W3GP:BST1:CHAN10:HSUP:EHIC:SSIN 0
```

**Relative Grant Pattern – HSUPA BS - 3GPP FDD** **(This feature is available for E-RGCH only.)**

Enters a pattern: 0 = Hold, + = Up, - = Down.

---

**Note:**

*Pattern + is entered using the numeric key 1. Pattern - is entered via the numeric key +/-.*

---

For Non Serving Cell "1" is not allowed.

Remote-control command:

```
SOUR:BB:W3GP:BST1:CHAN9:HSUP:ERGC:RGPA "-"
```

**ACK/NACK Pattern - BS -  
3GPP FDD****(This feature is available for E-HICH only.)**

Enters the pattern for the ACK/NACK field. For Non Serving Cell only "1" = ACK and "-" = NACK is allowed. For Serving Cells only "+" = ACK and "0" = NACK is allowed.

---

**Note:**

*Pattern + is entered using the numeric key 1. Pattern - is entered via the numeric key +/-.*

---

Remote-control command: n.a.

SOUR:BB:W3GP:BST1:CHAN10:HSUP:EHIC:RGPA "+"

**Tau DPCH - BS - 3GPP FDD**

Enters the offset of the downlink dedicated offset channels.

Remote-control command: n.a.

SOUR:BB:W3GP:BST1:CHAN12:HSUP:EHIC:DTAU 5

SOUR:BB:W3GP:BST1:CHAN12:HSUP:ERGC:DTAU 5

**Tau E-RGCH - BS - 3GPP  
FDD**

Displays the offset of the P-CCPCH frame boundary.

Remote-control command: n.a.

SOUR:BB:W3GP:BST1:CHAN12:HSUP:EHIC:ETAU?

SOUR:BB:W3GP:BST1:CHAN12:HSUP:ERGC:ETAU?

## Multi Channel Assistant - BS - 3GPP FDD

The **Multi Channel Assistant** menu is called with the button of the same name above the channel table. It allows several channels to be set simultaneously and is only available for the channel types DPCH, HS QPSK and HS 16QAM.

Enhanced state is automatically deactivated. The channel table is only filled with new values when the **Accept** button is pressed.

**Start Channel Number - Multichannel Base Station - 3GPP FDD** Enters the index for the start channel of the channel range, that is set jointly.  
Remote-control command: n.a.

**Stop Channel Number - Multichannel Base Station - 3GPP FDD** Enters the index for the stop channel of the channel range, that is set jointly.  
Remote-control command: n.a.

**Channel Type - Multichannel Base Station - 3GPP FDD** Enters the channel type for the channel range that is set jointly. Available for selection are DPCH, HS QPSK or HS 16QAM.  
Remote-control command: n.a.

- Slot Format - Multichannel Base Station - 3GPP FDD** Displays the slot format.  
For DPCH channels, the slot formats are 0 to 16.  
A slot format defines the structure of a slot made of data and control fields and includes the symbol rate.  
The individual parameters of a slot can later be changed, with the slot format being adjusted, if necessary.  
This parameter is not available for high-speed channels.  
Remote-control command: n.a.
- Symbol Rate - Multichannel Base Station - 3GPP FDD** Sets the symbol rate. The range of values depends on the channel selected.  
The symbol rate is determined by the slot format set. A change in the symbol rate leads automatically to an adjustment of the slot format.  
Remote-control command: n.a.
- Channelization Code - Multichannel Base Station - 3GPP FDD** Sets the channelization code for the start channel.  
The channel is spread with the specified channelization code (spreading code).  
The range of values of the channelization code depends on the symbol rate of the channel.  
$$0 \text{ to } \frac{\text{chip\_rate}(= 3.84\text{Mcps})}{\text{symbol\_rate}} - 1$$
  
Remote-control command: n.a.
- Channelization Code Step - Multichannel Base Station - 3GPP FDD** Sets the step width for the channelization code from channel to channel.  
The valid range of values for the channelization code of an individual channel must not be exceeded. If the range of values is exceeded, the channelization code is limited automatically.  
Remote-control command: n.a.

**Power - Multichannel Base Station - 3GPP FDD**

Sets the channel power of the start channel in dB.

The power entered is relative to the powers of the other channels and does not initially relate to the LEVEL power display. If **Adjust Total Power** is executed (top level of the 3GPP menu), all the power data is relative to 0 dB.

**Note:**

*The maximum channel power of 0 dB applies to non-blanked channels (duty cycle 100%), with blanked channels, the maximum value can be increased (by Adjust Total Power) to values greater than 0 dB (to  $10 * \log_{10} \frac{1}{\text{duty\_cycle}}$ ).*

*The Power value is also the starting power of the channel for Misuse TPC and Dynamic Power Control.*

Remote-control command: n.a.

**Power Step - Multichannel Base Station - 3GPP FDD**

Enters the step width for the change of channel power from channel to channel.

The valid range of values must not be exceeded. If the range of values is exceeded, the power is automatically limited to the permissible of -80 dB to 0 dB.

Remote-control command: n.a.

**Data Source (DPDCH) - Multichannel Base Station - 3GPP FDD**

Selects data source.

The following are available for selection as data sources:

Remote-control command: n.a.

**All 0**                      0 data and 1 data is generated internally.

**All 1**

**PRBSxx**                      PRBS data as per CCITT with period lengths between  $2^9-1$  and  $2^{23}-1$  is generated internally.

**Pattern**                      A user-definable bit pattern with a maximum length of 64 bits is generated internally.

**Pattern**

The bit pattern is defined in the **Pattern** entry field.

**Data List**                      Internal data from a programmable data list generated with the Data Editor or externally, is used.

**Select Data List**

The data list selection is called with the **Select Data List** button.

<b>DPCCH Settings - Multichannel Base Station - 3GPP FDD</b>	<p>Calls the menu for configuring DPCCH channels.</p> <p>The parameters of the menu are described in Section "<a href="#">DPCCH Settings - BS Channel Table 3GPP FDD</a>", page 4.397. In contrary to setting a single channel, the remote control commands are not available.</p> <p>Remote-control command: n.a.</p>
<b>Timing Offset - Multichannel Base Station - 3GPP FDD</b>	<p>Sets the timing offset for the start channel.</p> <p>The timing offset determines the shift of the source symbols before interleaving.</p> <p>The absolute starting time of the frame (slot 0) is shifted relative to the start of the scrambling code sequence by the timing offset * 256 chips. This means that whatever the symbol rate, the resolution of the timing offset is always 256 chips.</p> <p>This procedure is used to reduce the crest factor. A good way to obtain a lower crest factor is to use an offset of 1 from channel to channel, for example.</p> <p>Remote-control command: n.a.</p>
<b>Timing Offset Step- Multichannel Base Station - 3GPP FDD</b>	<p>Sets the step width for the timing offset from channel to channel.</p> <p>The valid range of values must not be exceeded. If the range of values is exceeded, the timing offset is automatically limited to the permissible range.</p> <p>Remote-control command: n.a.</p>
<b>Channel State- Multichannel Base Station - 3GPP FDD</b>	<p>Activates or deactivates all the channels in the set channel range.</p> <p>Remote-control command: n.a.</p>
<b>Accept- Multichannel Base Station - 3GPP FDD</b>	<p>Executes automatic completion of the channel table in accordance with the parameters set.</p> <p>Remote-control commands: n.a.</p>



## User Equipment Configuration (UE) - 3GPP FDD

The **User Equipment Configuration** menu is called by selecting user equipment **UE1** ... **UE4** in the 3GPP FDD menu.

### Note:

*In the standard, the term "Mobile Station" has been replaced by the term "User Equipment", to take into account the fact that there is a great variety of mobile terminal equipment available to users, with functionality that is constantly being enhanced.*

A user equipment has a maximum of 6 DPDCHs, with parameters largely prescribed by the standard (TS 25 211). To simplify operation, a distinction is made between three modes (**PRACH only**, **PCPCH only** and **DPCCH + DPDCH**).

With the DPCCH + DPDCH mode, the high speed channel HS-DPCCH can be activated.

With the PRACH only and PCPCH only modes, there is also a choice between **Standard** (all parameters can be set) and **Preamble only** (only the preamble can be set). The menu of each particular mode only displays the parameters that are relevant.

User equipment 1 (UE1) generates all the channels in enhanced mode (realtime).

The menu comprises an upper section **Common Settings**, with central sections **PRACH Settings**, **PCPCH Settings** or **DPCCH Settings** with **DPDCH Settings**, depending on which mode is set. When **DPCCH + DPDCH** modes are selected, the only the channel structure, the state and the channel power are indicated. The **Channel Table** section also appears below. The section for detailed setting and the channel table can be revealed with the **Show Details >>>** button and hidden with the **<<< Hide Details** button.

In the menu for user equipment 1, under DPDCH settings, there is a menu for setting the enhanced channel parameters. When **PRACH only** or **PCPCH only** mode is selected, the **Channel Coding** section also appears below.

In the menus for user equipment 2, 3 and 4, the compressed mode can be activated and configured (**Use Compressed Mode**).

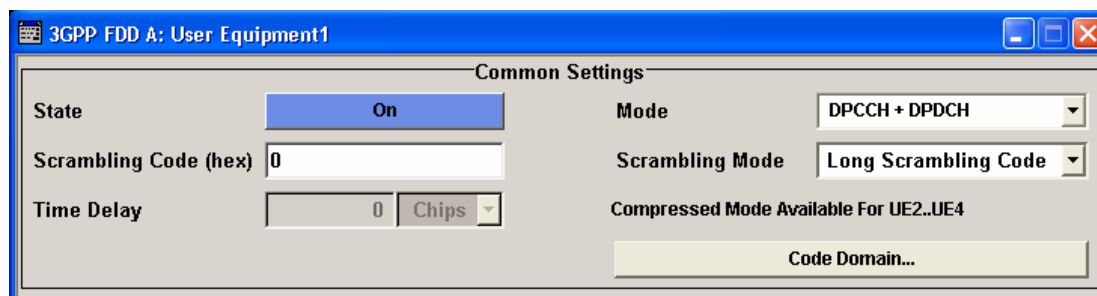

**DPDCH Settings**

<b>Pilot</b> 6	<b>TFCI</b> 2	<b>TPC</b> 2
-------------------	------------------	-----------------

<<< Hide Details

DL-UL Timing Offset: 1024 Chips

Slot Format #: 0

FBI Mode: Off

TPC Data Source: All 0

Read Out Mode: Continuous

Power Step TPC: 0.00 dB

Power: 0.00 dB

Channelization Code: Q / 0

Use  TFCI: 0

FBI Pattern (bin): 0...

**DPDCH Settings**

Data  
40

State:  On

Channel Power: 0.00 dB

<<< Hide Details

Overall Symbol Rate: 60 ksps

Force Channelization Code To 1 / 0:  On

Global Enhanced Channels...

	1	2	3	4	5	6
Channel Type	DPDCH	DPDCH	DPDCH	DPDCH	DPDCH	DPDCH
Symbol Rate / State	60	Off	Off	Off	Off	Off
ChannelizationCode	1 / 16					
DPDCH Data Source	PN 9					
DPDCH Pattern	0					
DPDCH Data List	None					
DCCH Data Source		Channel	Coding	Off		
DCCH Pattern						
DCCH Data List						

**HS-DPDCH Settings**

<b>HARQ-ACK (Slots)</b> 1	<b>CQI (Slots)</b> 2
------------------------------	-------------------------

State:  On

Power: 0.00 dB

<<< Hide Details

Start Delay: 101 \*256 Chips

Inter TTI Distance: 5 Subframes

ACK/NACK Pattern (bin): 1...

CQI Pattern Length: 1

CQI Values: 1

Power Offset ACK: 0.0 dB

Power Offset NACK: 0.0 dB

Channelization Code: Q / 64

E-DPCCH Settings

<b>Retrans Sequence Number</b> 2	<b>E-TFCI Information</b> 7	<b>Happy</b> 1
-------------------------------------	--------------------------------	-------------------

State  On      Power  dB

<<< Hide Details

Retrans Sequence Number       Channelization Code

E-TFCI Information       Happy Bit

E-DCH TTI  Use  DTX Pattern (bin)

HSUPA FRC

E-DPDCH Settings

Data  
1280

State  On      Channel Power  dB

<<< Hide Details

Overall Symbol Rate       Force Channelization Code To I/O

E-DCH TTI  Use  DTX Pattern (bin)

	1	2	3	4
Channel Type	E-DPDCH	E-DPDCH	E-DPDCH	E-DPDCH
Symbol Rate / State	60	Off	Off	Off
ChannelizationCode	1 / 32			
E-DPDCH Data Source	PN 9			
E-DPDCH Pattern	0			
E-DPDCH Data List	None			

## Common Settings - UE - 3GPP FDD

The **Common Settings** section is where the general settings for the selected user equipment are made.

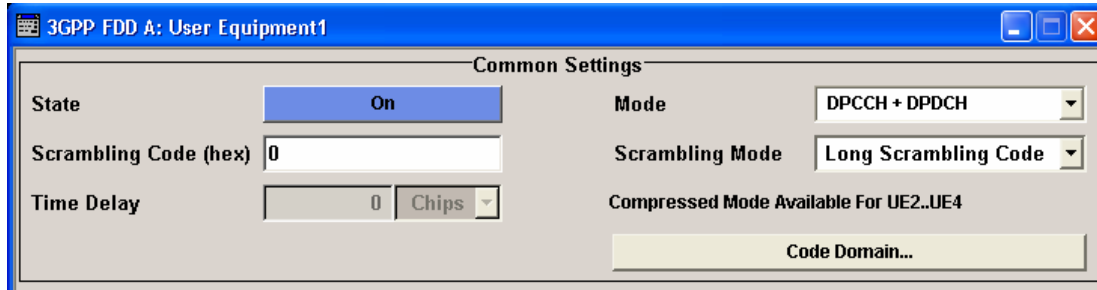

### State - UE - 3GPP FDD

Activates or deactivates the selected user equipment. The number of the selected user equipment is specified in the menu header.

Remote-control command:

```
SOUR:BB:W3GP:MST1:STAT ON
```

### Mode - UE - 3GPP FDD

Selects the mode in which the user equipment is to work. The lower part of the menu will change in accordance with the mode. The following modes are available:

#### PRACH only - Standard

In this mode, the instrument generates a single physical random access channel (PRACH). This channel is needed to set up the connection between the user equipment and the base station. All the PRACH parameters can be set in the **PRACH Settings** section (see Section "[PRACH Settings - UE - 3GPP FDD](#)", page 4.424).

Remote-control command:

```
SOUR:BB:W3GP:MST2:MODE PRAC
```

#### PRACH only - Preamble only

In this mode, the instrument only generates the preamble of a physical random access channel (PRACH). Only the PRACH preamble parameters can be set in the **PRACH Settings** section. This mode is needed for Test Case 8.8 TS 25.141.

Remote-control command:

```
SOUR:BB:W3GP:MST2:MODE PPR
```

**PCPCH only - Standard**

In this mode the instrument generates a single physical common packet channel (PCPCH). This channel is used to transmit packet-oriented services (e.g. SMS). The specific PCPCH parameters can be set in the **PCPCH Settings** section (see Section "

[PCPCH Settings - UE - 3GPP FDD](#)", page 4.432).

Remote-control commands:

SOUR:BB:W3GP:MST2:MODE PCPC

**PCPCH only - Preamble only**

In this mode, the instrument only generates the preamble of a physical common packet channel (PCPCH). Only the PRACH preamble parameters can be set in the **PCPCH Settings** section. This mode is needed for Test Case 8.9 TS 25.141.

Remote-control commands:

SOUR:BB:W3GP:MST2:MODE PPCP

**DPCCH + DPDCH**

In this mode the instrument generates a control channel (DPCCH) and up to 6 data channels (DPDCH). This mode corresponds to the standard mode of a user equipment during voice and data transmission.

Alternatively a high speed HS-DPCCH can be activated.

Channel-specific parameters can be set in the **DPCCH Settings** and **DPDCH Settings** sections.

When UE1 is selected, the signal is generated in realtime (realtime; enhanced). All the channels (DPCCH + 6 DPDCH) can be generated simultaneously in realtime (see Sections "[DPCCH Settings - UE - 3GPP FDD](#)", page 4.442 and "[DPDCH Settings - UE - 3GPP FDD](#)", page 4.454)

Remote-control command:

SOUR:BB:W3GP:MST2:MODE DPCD

**Scrambling Code - UE - 3GPP FDD**

Sets the scrambling code.

The scrambling code is used to distinguish the transmitter (UE) by transmitter-dependent scrambling. Hexadecimal values are entered. Long or short scrambling codes can be generated (see also section "[Scrambling Code Generator](#)", Page 4.312).

Remote-control command:

SOUR:BB:W3GP:MST1:SCOD #H1

**Scrambling Mode - UE - 3GPP FDD**

Sets the type of scrambling code.

With scrambling code, a distinction is made between **Long** and **Short Scrambling Code** (see also Section "[Scrambling Code Generator](#)", Page 4.312).

**Off**

Disables scrambling code for test purposes.

Remote-control command:

SOUR:BB:W3GP:MST2:SCOD:MODE OFF

**Long Scrambling Code**

Sets the long scrambling code.

Remote-control commands:

SOUR:BB:W3GP:MST2:SCOD:MODE LONG

**Short Scrambling Code**  
(only modes **DPCCH + DPDCH** and **PCPCH** only)

Sets short scrambling code.

The short scrambling code is only standardized for DPCCH and DPDCH channels. But it can also be generated for the PCPCH channel for test purposes.

Remote-control command:

SOUR:BB:W3GP:MST2:SCOD:MODE SHOR

**Time Delay - UE - 3GPP FDD**

Enters the time delay of the signal of the selected user equipment compared to the signal of user equipment 1.

Remote-control command:

SOUR:BB:W3GP:MST2:TDEL 256

**Use Compressed Mode- UE - 3GPP FDD (This feature is available for UE 2...4 and DPCCH+DPDCH Mode only.)**

Activates compressed mode.

The Compressed mode is configured in the submenu called by button **Compressed Mode**.

The menu is described in section "[Compressed Mode - User Equipment - 3GPP FDD](#)", page 4.419.

Remote-control command:

SOUR:BB:W3GP:MST2:CMOD:STAT ON

## Code Domain Graph - UE - 3GPP FDD

The button **Code Domain ...** above the channel table calls a graphical display of the assigned code domain.

The **Code Domain** display indicates the assigned code domain. The channelization code is plotted at the X axis, the colored bars indicate coherent code channels. The colors are assigned to fixed symbol rates, the allocation is shown below the graph. The relative power can be taken from the height of the bar. The symbols on so-called I- and Q-branches are spread independently. The channelization codes are fixed for the channels.

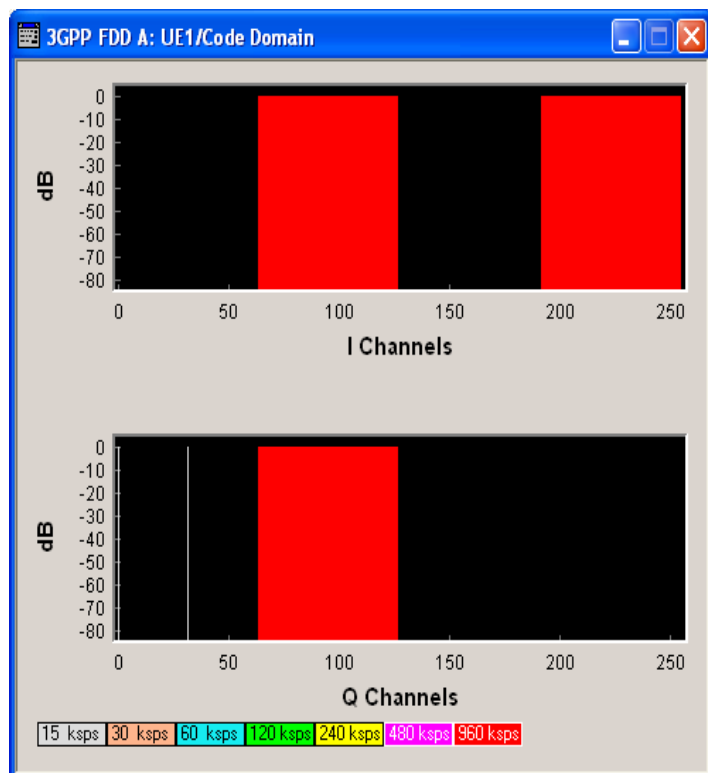

It is possible to determine from this display whether the settings made have resulted in a code domain conflict, that is to say, whether the code domains of the active channels intersect. A code domain conflict is indicated by overlapping bars. It may occur only when switch **Force Channelization Code to I/Q** is activated.

### Compressed Mode - User Equipment - 3GPP FDD

To enable handover of a mobile station from a 3GPP FDD user equipment to another user equipment, (3GPP FDD, 3GPP TDD or GSM) at a different frequency, transmission and reception of the 3GPP FDD signal must be interrupted for a short time. During this time, the mobile station changes to the frequency of the new user equipment, for example to measure the receive level of this station or read system information.

To transmit a consistently high data volume also in the remaining (shorter) period of time, the data is compressed. This can be done by halving the spreading factor (SF/2 method) or reducing error protection (puncturing method). In both cases, transmit power in the ranges concerned is increased to maintain adequate signal quality.

Apart from these two methods, there is also the method of "higher layer scheduling". With this method, transmission of the data stream is stopped during the transmission gap. This method is suitable for packet-oriented services; it involves no power increase (power offset) in the active ranges.

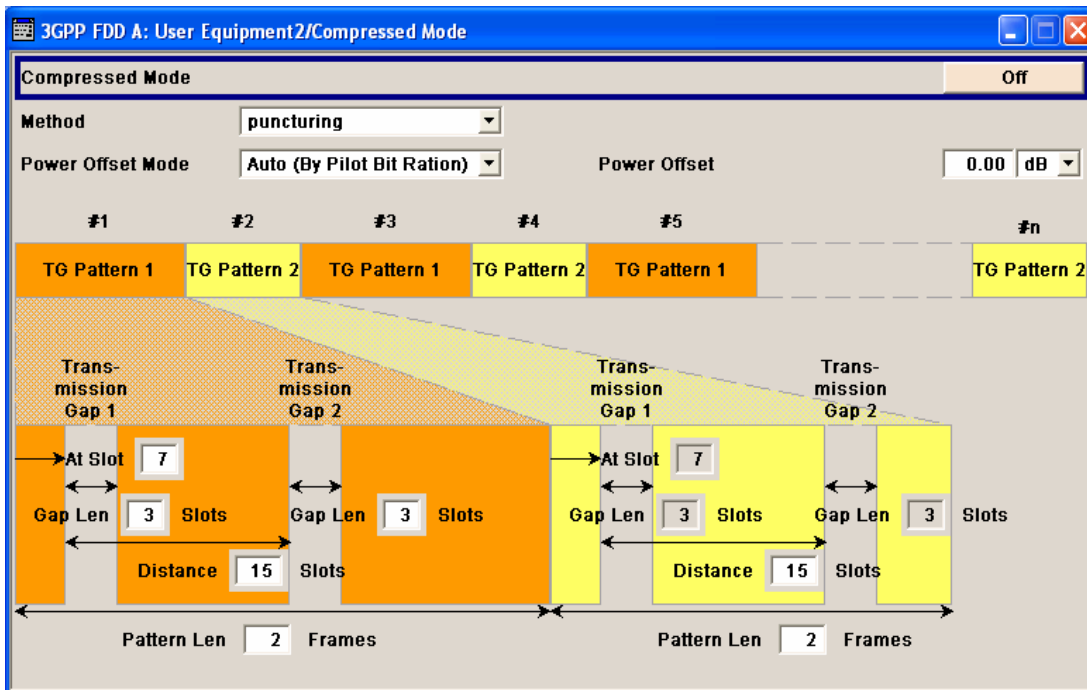

**Compresses Mode State - UE - 3GPP FDD** (This feature is available for UE 2...4 and DPCCH+DPDCH Mode only.)

Activates compressed mode.

Remote-control command:

SOUR:BB:W3GP:MST2:CMOD:STAT ON

**Compressed Mode Method - UE - 3GPP FDD** (This feature is available for UE 2...4 and DPCCH+DPDCH Mode only.)

Selects compressed mode method.

**Higher layer scheduling**

The data is compressed by stopping the transmission of the data stream during the transmission gap.

Remote-control command:

SOUR:BB:W3GP:MST2:CMOD:METH HLSC

**SF/2**

The data is compressed by halving the spreading factor.

Remote-control command:

SOUR:BB:W3GP:MST2:CMOD:METH SF2



**Power Offset Mode - UE -  
3GPP FDD**

**(This feature is available for UE 2...4 and DPCCH+DPDCH Mode only.)**

Selects power offset mode.

The compressed slots can be sent with a power offset, i.e. at an increased power level.

**Auto (By Pilot Bit Ratio)** The power offset is obtained as follows:

$$\frac{\text{Number of pilots bits of non-compressed slots}}{\text{Number of pilot bits by compressed slots}}$$

Number of pilot bits by compressed slots

Remote-control command:

SOUR:BB:W3GP:MST2:CMOD:POM AUTO

**User**

The power offset is defined manually. The value is input in entry field **Power Offset**.

Remote-control command:

SOUR:BB:W3GP:MST2:CMOD:POM USER

**Power Offset - UE - 3GPP  
FDD**

**(This feature is available for UE 2...4 only.)**

Defines power offset.

The input is only valid for Power Offset Mode User.

Remote-control command:

SOUR:BB:W3GP:MST2:CMOD:POFF 3dB

## Compressed Mode Configuration Graph - User Equipment - 3GPP FDD

The remaining parameters of the compressed mode are set in the configuration graph. The graph displays the distribution of transmission gaps in a compressed mode signal.

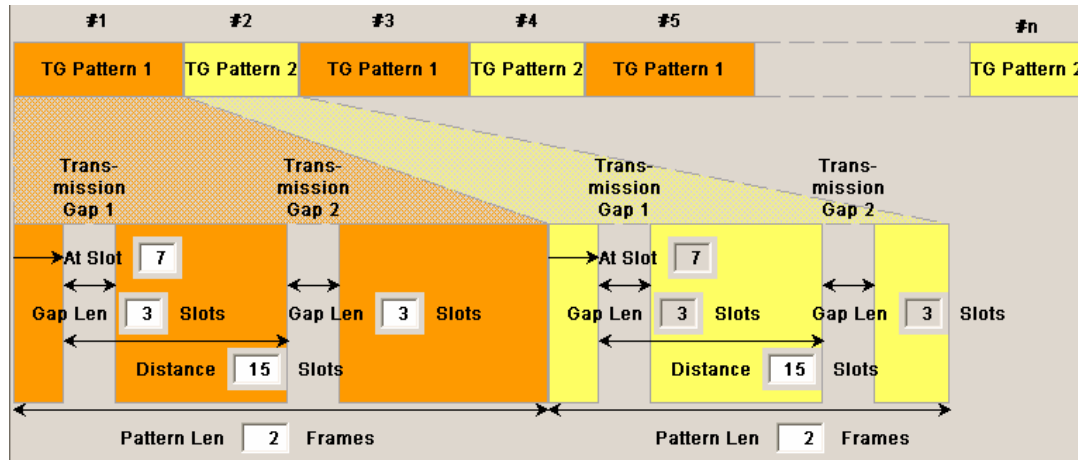

The signal generated can be divided into three subranges:

### Transmission Gaps

A transmission gap has a maximum length of 14 slots. Since at least eight active slots must be sent per frame, gaps comprising seven slots and more have to be distributed over two neighboring frames.

The transmitted signal consists of max. two patterns that are sent alternately. Each pattern comprises two transmission gaps.

The graph includes all parameters necessary to define the transmission gaps in the signal:

#### Note:

*The settings here are also valid for the compressed mode graph of the base station with the same number. For example, setting a distance of 9 slots for user equipment 4 also sets the distance to 9 slots for base station 4.*

#### At Slot

**(This feature is available for UE 2...4 only.)**

Transmission gap slot number. Slot number of pattern 2 is the same as slot number of pattern 1.

Remote-control command:

SOUR:BB:W3GP:MST2:CMOD:PATT1:TGSN 4

#### Gap Len

**(This feature is available for UE 2...4 only.)**

Transmission gap lengths. Gap lengths of pattern 2 is the same as gap lengths of pattern 1.

Remote-control command:

SOUR:BB:W3GP:MST2:CMOD:PATT1:TGL2 7

**Distance** (This feature is available for UE 2...4 only.)

Transmission gap distance.

Remote-control command:

SOUR:BB:W3GP:MST2:CMOD:PATT2:TGD 4

**Pattern Len:** (This feature is available for UE 2...4 only.)

Transmission gap pattern length.

The input range is 0 ... 100 frames for pattern 1 and 1 ... 100 frames for pattern 2. Thus, it is possible to configure transmission gap pattern with only one pattern.

Remote-control command:

SOUR:BB:W3GP:MST2:CMOD:PATT2:TGPL 23

The above parameters are interrelated in many ways. For example, the transmission gap distance must be selected so that no frame contains more than one gap. In the event of an invalid entry, the next valid value is automatically set. If the entry is valid but changes the valid range for another parameter, the setting of the parameter is adapted.

In the above example, the signal (or more precisely: the pattern of transmission gaps) is repeated every 4 frames.

### Compressed Ranges

All slots of a frame that are not blanked are compressed. If the transmission gap is transmitted within one frame (single-frame method), an envelope as shown by the diagram below is obtained:

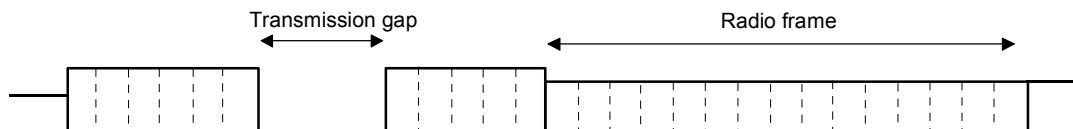

Fig. 4-35 Envelope of compressed mode signal with single-frame method

If the transmission gap is distributed over two neighboring frames, all slots of the two frames that are not blanked are compressed:

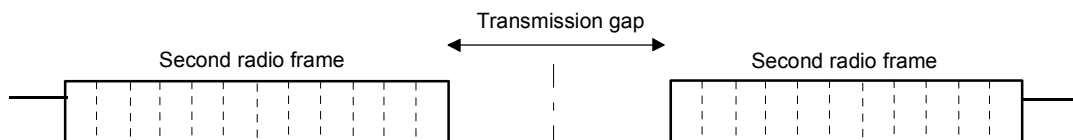

Fig. 4-36 Envelope of compressed mode signal with double-frame method

A different slot format, usually with a higher number of pilot bits, is used in the compressed ranges.

The transmit power can be increased (**Power Offset Mode**) automatically or manually by defining a power offset.

### Non-compressed ranges

Frames containing no transmission gaps are sent with the same slot format and the same power as in the non-compressed mode.

# PRACH Settings - UE - 3GPP FDD

The **PRACH Settings** section is where the settings are made for the PRACH channel. This section is only available when **PRACH only** mode is activated.

In **Standard** mode, the instrument generates a single physical random access channel (PRACH). This channel is needed to set up the connection between the user equipment and the base station.

In **Preamble only** mode, the instrument only generates the preamble of a physical random access channel (PRACH). This mode is needed for Test Case 8.8 TS 25.141.

When the selection is **PRACH only - Standard**, all the parameters described below are available, when the selection is **PRACH only - Preamble only**, only the preamble parameters are available.

The menu section is subdivided into the graphical display of the PRACH including the timing parameters and the **Preamble Settings** and **Message Part** sections, in which the settings are made for the preamble and for the data part of the channel. Some settings are made directly in the input fields of the graphical display.

The **Channel Coding** section for activating channel coding is available for UE1 with enhanced channels.

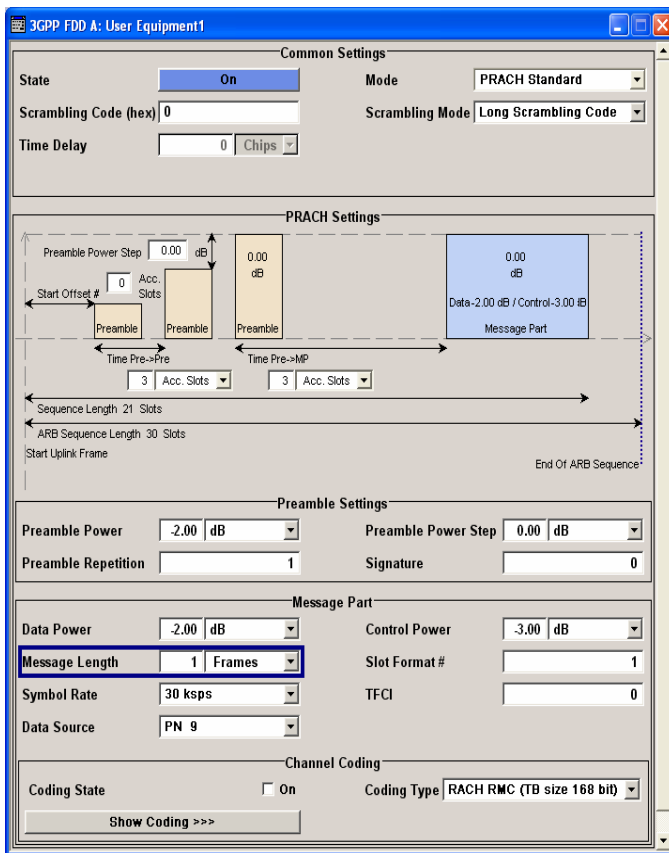

The graphical display shows either the complete PRACH including the message part or only the preamble depending on the selected mode

### Display for PRACH - Preamble-only mode

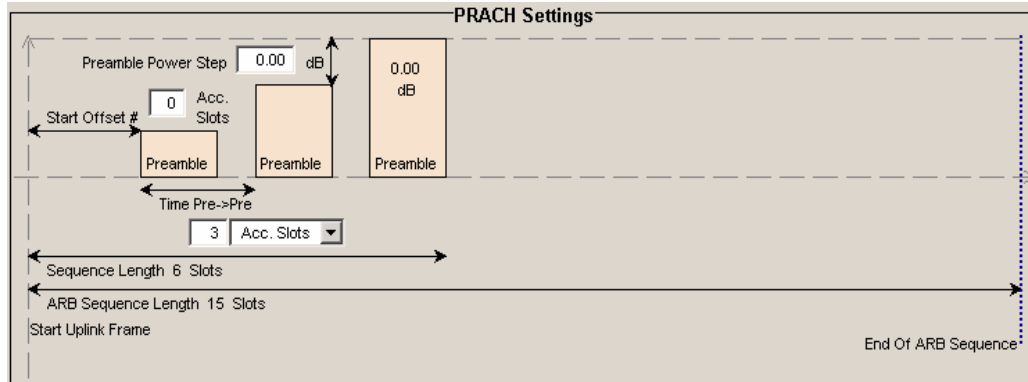

### Display for PRACH - Standard mode

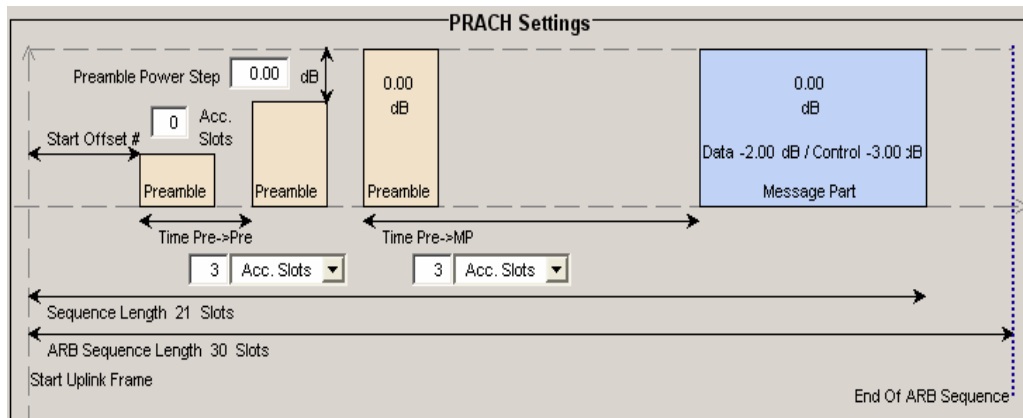

Some of the parameter values can be input directly in the input fields of the graphical display. However, the displayed settings of most parameters does not correspond to their real settings. They are shown as an example to explain the parameter function. An exception are the indicated sequence period and the power correction values, they match the real settings. This allows the user to check if the sequence period fits into the set ARB sequence length. The power correction values can be used to calculate the correct settings for the desired RF level:

The graphic indicates the correction value for the last preamble before the message part (indication in the preamble block,  $\Delta\text{PowPre}$ ) and the correction values for the message part overall and separately for data and control part (indications in the message part block,  $\Delta\text{PowMP}$ ). The power of the other preambles can be calculated by subtracting the set **Preamble Power Step**.

For one active UE, the RF power of the message part is calculated by adding the set RF level to the correction value.

#### Example:

**Level** = 5 dBm

**$\Delta\text{PowMP}$**  = 2,3 dB

The message part power is 7,3 dBm

<b>Delta Power - Preamble - PRACH UE - 3GPP FDD (graphical display)</b>	<p>Indication of the level correction value for the last preamble before the message part.</p> <p>The level of the other preambles can be calculated by subtracting the set <b>Preamble Power Step</b>.</p> <p>Remote-control command: SOUR:BB:W3GP:MST2:PRAC:TIM:DPOW:PRE?</p>
<b>Delta Power - Message Part - PRACH UE - 3GPP FDD</b>	<p>Indication of the level correction value for the message part.</p> <p>In addition to the total value of the message part power, the power offsets of the data and control part are indicated separately. The indication of the total value is important for measurements where just the envelope of the signal is of interest whereas the separate indication is useful for receiver tests.</p> <p>In case of one UE active, the power of the message part can be calculated by adding the set RF level:</p> <p>Example: <b>Level</b> = 5 dBm + <math>\Delta</math><b>PowMP</b> = 2,3 dB = 7,3 dBm.</p> <p>Remote-control command SOUR:BB:W3GP:MST2:PRAC:TIM:DPOW:MPAR? SOUR:BB:W3GP:MST2:PRAC:TIM:DPOW:MPAR:DATA? SOUR:BB:W3GP:MST2:PRAC:TIM:DPOW:MPAR:CONT?</p>
<b>Start Offset - PRACH UE - 3GPP FDD (graphical display)</b>	<p>Enters the start offset of the PRACH in access slots.</p> <p>The starting time delay in timeslots is calculated according to:</p> <p>2 x Start Offset #</p> <p>Remote-control command: SOUR:BB:W3GP:MST2:PRAC:TIM:SOFF 1</p>
<b>Transmission Time - Preamble - PRACH UE - 3GPP FDD (graphical display)</b>	<p>Enters the time difference between two successive preambles in access slots.</p> <p>Remote-control command: SOUR:BB:W3GP:MST2:PRAC:TIM:TIME:PREP 4</p>
<b>Transmission Time - Message Part - PRACH UE - 3GPP FDD (graphical display)</b>	<p>Enters the time difference between the last preamble and the message part in access slots or slots.</p> <p>Two modes are defined in the standard. In mode 0, the preamble to message part difference is 3 access slots, in mode 1 it is 4 access slots.</p> <p>Remote-control command: SOUR:BB:W3GP:MST2:PRAC:TIM:TIME:PREM 4</p>

**Sequence Length - PRACH  
UE - 3GPP FDD (graphical  
display)**

Indication of the sequence length.

This indication allows the user to check if the sequence period fits into the set ARB sequence length.

In **PRACH only - Preamble** mode, the sequence period is defined by settings **Start Offset**, **Time Pre - Pre** and **Preamble Repetition**:

Sequence Length = Start Offset (Slots) + Preamble Repetition x Time Pre - Pre

**Example:**

Start Offset = 2 Access Slots = 4 Slots

Preamble Repetition = 3

Time Pre - Pre = 3 Access Slots = 6 Slots

Sequence Length = 4 Slots + 3 x 6 Slots = 22 Slots

In **PRACH only - Standard** mode, the sequence period is defined by settings **Start Offset**, **Time Pre - Pre**, **Time Pre - Pre**, **Message Part Length** and **Preamble Repetition**:

Sequence Length = Start Offset (Slots) + (Preamble Repetition - ) x Time Pre - Pre + Time Pre - MP + 15 x Message Part Length (Frames)

**Example:**

Start Offset = 2 Access Slots = 4 Slots

Preamble Repetition = 3

Time Pre - Pre = Time Pre - MP = 3 Access Slots = 6 Slots

Message Part Length = 2 Frames

Sequence Length = 4 Slots + 2 x 6 Slots + 6 Slots + 15 x 2 = 52 Slots

Remote-control command:

SOUR:BB:W3GP:MST2:PRAC:TIM:SPER?

**ARB Sequence Length -  
PRACH UE - 3GPP FDD  
(graphical display)**

Indication of the ARB sequence length.

This indication allows the user to check if the sequence period fits into the set ARB sequence length.

Remote-control command:

SOUR:BB:W3GP:SLEN?

The **Preamble Settings** section is where the settings for the preamble are available.

**Preamble Power - PRACH  
UE - 3GPP FDD**

Sets the power of the preamble component of the PRACH channel.

Remote-control command:

SOUR:BB:W3GP:MST2:PRAC:PPOW -5

**Preamble Power Step -  
PRACH UE - 3GPP FDD**

Sets the power by which the preamble is increased from repetition to repetition. The power set under **Preamble Power** is the "target power", used during the last repetition of the preamble.

**Example:**

Setting:

**Preamble Power**                    0 dB  
**Preamble Repetition**            3  
**Preamble Power Step**            3 dB

Generated power sequence:

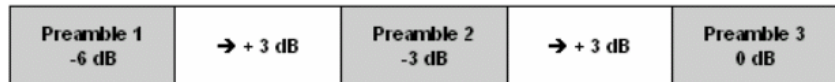

Remote-control command:

SOUR:BB:W3GP:MST2:PRAC:PPOW:STEP

**Preamble Repetition -  
PRACH UE - 3GPP FDD**

Sets the preamble count.

Remote-control command:

SOUR:BB:W3GP:MST2:PRAC:PREP 3

**Signature - PRACH UE -  
3GPP FDD**

**(This feature is available for the PRACH only – Standard mode only.)**

Selects the signature to be used for the PRACH channel.

The signature defines the code domain for the channelization code being used. 16 fixed bit patterns are defined.

Remote-control command:

SOUR:BB:W3GP:MST2:PRAC:SIGN 1

The **Message Part** section is where the settings for the data part of the PRACH are available. This section is only available when **PRACH only - Standard** is selected.

**Data Power - PRACH UE -  
3GPP FDD**

**(This feature is available for the PRACH only – Standard mode only.)**

Sets the power of the data component of the PRACH channel.

Remote-control command:

SOUR:BB:W3GP:MST2:PRAC:DPOW -3

**Control Power - PRACH UE  
- 3GPP FDD**

**(This feature is available for the PRACH only – Standard mode only.)**

Sets the power of the control component of the PRACH channel.

Remote-control command:

SOUR:BB:W3GP:MST2:PRAC:CPOW -3



**Message Length - PRACH UE - 3GPP FDD** (This feature is available for the PRACH only – Standard mode only.)

Sets the length of the message component of the PRACH channel in frames.

Remote-control command:

SOUR:BB:W3GP:MST2:PRAC:MLEN 1

**Slot Format - PRACH UE - 3GPP FDD** (This feature is available for the PRACH only – Standard mode only.)

Selects the slot format.

Slot formats 0 to 4 are available for the PRACH channel. The slot format defines the parameters (symbol rate and TFCI) of the message component.

Remote-control command:

SOUR:BB:W3GP:MST2:PRAC:SFOR 1

**Symbol Rate - PRACH UE - 3GPP FDD** (This feature is available for the PRACH only – Standard mode only.)

Sets the symbol rate of the PRACH channel.

The symbol rate is determined by the slot format set. A change in the symbol rate leads automatically to an adjustment of the slot format.

Remote-control command:

SOUR:BB:W3GP:MST2:PRAC:SRAT D15K

**TFCI - PRACH UE - 3GPP FDD** (This feature is available for the PRACH only – Standard mode only.)

Enters the value of the TFCI field (Transport Format Combination Indicator) in the control component of the PRACH channel

Remote-control command:

SOUR:BB:W3GP:MST2:PRAC:TFCI 2

**Data Source - PRACH UE - 3GPP FDD** (This feature is available for the PRACH only – Standard mode only.)

Selects the data source for the data component of the PRACH channel.

The following data sources are available for selection

**All 0** 0 data and 1 data is generated internally.

**All 1** Remote-control command:  
SOUR:BB:W3GP:MST2:PRAC:DATA ZERO | ONE

**PN xx** PRBS data as per CCITT with period lengths between  $2^9-1$  and  $2^{23}-1$  is generated internally.

Remote-control command:

```
SOUR:BB:W3GP:MST2:PRAC:DATA PN9
```

**Pattern**  
**Pattern** A user-definable bit pattern with a maximum length of 64 bits is generated internally.

The bit pattern is defined in the **Data Pattern** entry field.

Remote-control command:

```
SOUR:BB:W3GP:MST2:PRAC:DATA PATT
```

```
SOUR:BB:W3GP:MST2:PRAC:DATA:PATT
```

```
#H0,1
```

**Data List**  
**Select**  
**Data List** Internal data from a programmable data list generated with the Data Editor or externally, is used.

Data lists are selected in the **File Select** window, which is called by means of the **Select Data List** button.



The **File Manager** is used to transmit external data lists to the R&S Vector Signal Generator, and can be called within every **File Select** window by means of the **File Manager** button.

Remote-control command:

```
SOUR:BB:W3GP:MST2:PRAC:DATA DLIS
```

```
SOUR:BB:W3GP:MST2:PRAC:DATA: DSEL
```

```
'prach1'
```

## Channel Coding State - PRACH UE - 3GPP FDD

The **Channel Coding** section is where the channel coding for the PRACH channel is activated and deactivated and the coding type is defined. Use **Show Coding>>>** to display the fixed settings for the channel coding parameters.

Channel coding of PRACH is possible for all UEs.

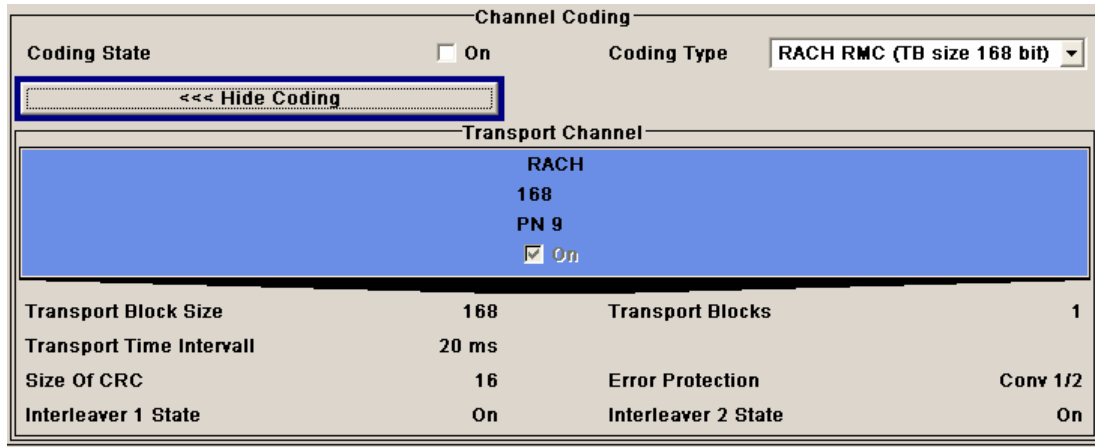

Channel Coding			
Coding State	<input type="checkbox"/> On	Coding Type	RACH RMC (TB size 168 bit)
<<< Hide Coding			
Transport Channel			
RACH			
168			
PN 9			
<input checked="" type="checkbox"/> On			
Transport Block Size	168	Transport Blocks	1
Transport Time Intervals	20 ms		
Size Of CRC	16	Error Protection	Conv 1/2
Interleaver 1 State	On	Interleaver 2 State	On

### Channel Coding State - PRACH UE - 3GPP FDD

Activates or deactivates channel coding for the PRACH channel.

When On, the **Message Part Length** automatically is set to 2. It cannot be changed.

Remote-control command:

```
SOUR:BB:W3GP:MST2:ENH:PRAC:CCOD:STAT ON
```

### Channel Coding Type - PRACH UE - 3GPP FDD

Selects the predefined reference measurement channel coding types for the PRACH channel. Available for selection are:

RACH RMC (TB size 168 bit)

RACH RMC (TB size 360 bit)

Remote-control command:

```
SOUR:BB:W3GP:MST2:ENH:PRAC:CCOD:TYPE TB360
```

### Show Coding - PRACH UE - 3GPP FDD

Calls the menu for displaying the channel coding settings. The reference measurement channel parameters are set to fixed values.

Remote-control command: n.a.

The following parameters are displayed:

**Data Source** The data source is displayed in the transport channel graphical display.

**Transport Block Size** Size of the transport block at the channel coding input.

<b>Transport Block</b>	Transport block count.
<b>Transport Time Interval</b>	Number of frames into which a TCH is divided.
<b>Size of CRC</b>	CRC type (length).
<b>Error Protection</b>	Error protection.
<b>Interleaver 1 / 2 State</b>	Channel coding interleaver state

## PCPCH Settings - UE - 3GPP FDD

The **PCPCH Settings** section is where the settings are made for the PCPCH channel. This section is only available when **PCPCH only** mode is activated.

In **Standard** mode, the instrument generates a single physical common packet channel (PCPCH). This channel is used to transmit packet-oriented services (e.g. SMS).

In **Preamble only** mode, the instrument only generates the preamble of a physical common packet channel (PCPCH). This mode is needed for Test Case 8.9 TS 25.141.

When the selection is **PCPCH only - Standard**, all the parameters described below are available, when the selection is **PCPCH only - Preamble only**, only the preamble parameters are available.

The menu section is subdivided into the graphical display of the PCPCH including the timing parameters and the **Preamble Settings** and **Message Part** sections, in which the settings are made for the preamble and for the data part of the channel. Some settings are made directly in the input fields of the graphical display.

The **Channel Coding** section for activating channel coding is available for UE1 with enhanced channels.

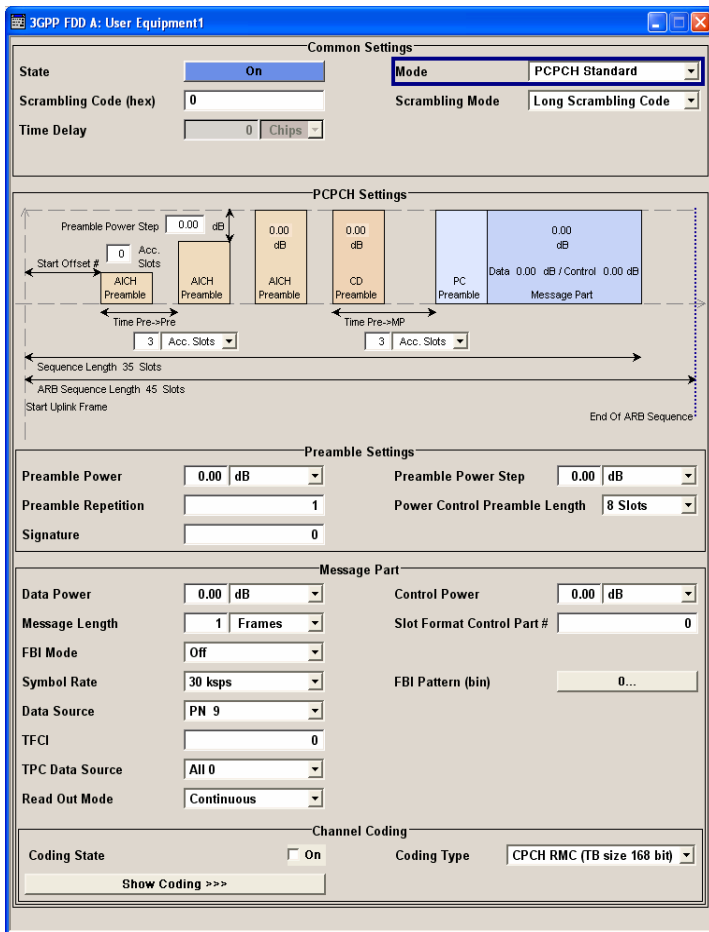

The graphical display shows either the complete PCPCH including the message part or only the preamble depending on the selected mode

**Display for PCPCH - Standard mode**

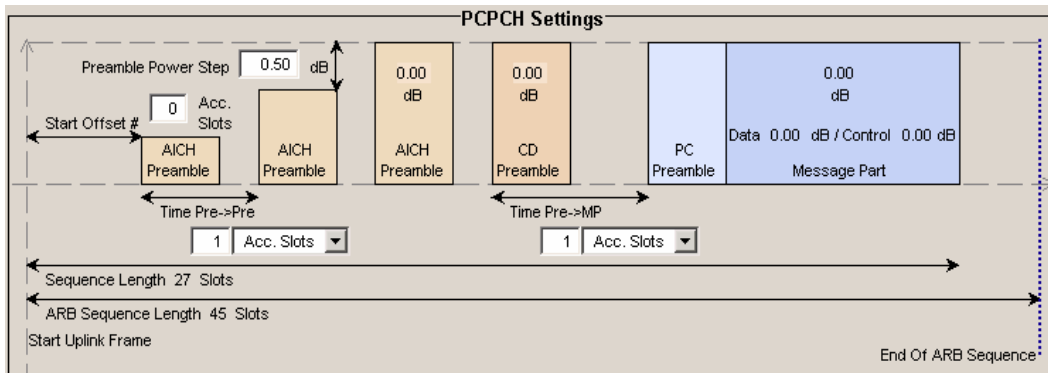

## Display for PCPCH - Preamble-only mode

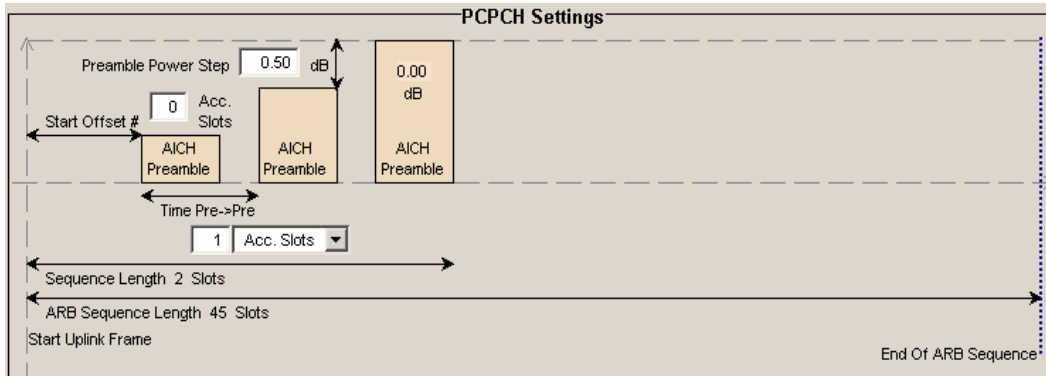

Some of the parameter values can be input directly in the input fields of the graphical display. However, the displayed settings of most parameters does not correspond to their real settings. They are shown as an example to explain the parameter function. An exception are the indicated sequence lengths and the power correction values, they match the real settings. This allows the user to check if the sequence period fits into the set ARB sequence length. The power correction values can be used to calculate the correct settings for the desired RF level:

The graphic indicates the correction value for the last AICH preamble before the message part and the CD Preamble (indication in the AICH and CD Preamble block,  $\Delta\text{PowPre}$ ). These two values are identical. The power of the other preambles can be calculated by subtracting the set **Preamble Power Step**. It also indicates the power correction value of the message part (indication in the message part block,  $\Delta\text{PowMP}$ ).

For one active UE, the RF power of the message part is calculated by adding the set RF level to the correction value.

**Example:**

Level = 5 dBm  
 $\Delta\text{PowMP} = 2,3$  dB

The message part power is 7,3 dBm

**Delta Power - Preamble - PCPCH UE - 3GPP FDD (graphical display)**

Indication of the level correction value for the last AICH preamble before the message part. This value is identical to the correction value for the CD preamble.

The level of the other preambles can be calculated by subtracting the set Preamble Power Step.

Remote-control command:

SOUR:BB:W3GP:MST2:PCPC:TIM:DPOW:PRE?

**Delta Power - Message Part - PCPCH UE - 3GPP FDD (graphical display)**

Indication of the level correction value for the message part.

In case of one UE active, the power of the message part can be calculated by adding the set RF level:

Example: Level = 5 dBm +  $\Delta\text{PowMP} = 2,3$  dB = 7,3 dBm.

Remote-control command

SOUR:BB:W3GP:MST2:PCPC:TIM:DPOW:MPAR?

**Start Offset - PCPCH UE -  
3GPP FDD (graphical  
display)**

Enters the start offset of the PCPCH in access slots or slots.

---

**Note:**

*The PCPCH only transmitted once, at the start of the sequence.*

---

The starting time delay in timeslots is calculated according to:

2 x Start Offset #

TS 25 211Kapitel 7.3 PCPCH/AICH timing relation

Remote-control command:

SOUR:BB:W3GP:MST2:PCPC:TIM:SOFF 1

**Transmission Timing -  
Preamble - PCPCH UE -  
3GPP FDD (graphical  
display)**

Enters the time difference between two successive preambles in access slots or slots.

Remote-control command:

SOUR:BB:W3GP:MST2:PCPC:TIM:TIME:PREP 4

**Transmission Timing -  
Message Part - PCPCH UE -  
3GPP FDD (graphical  
display)**

Enters the time difference between the last preamble and the message part in access slots or slots.

Two modes are defined in the standard. In mode AICH transmission timing 0, the preamble to message part difference is 3 access slots, in mode AICH transmission timing 1 it is 4 access slots.

Remote-control command:

SOUR:BB:W3GP:MST2:PCPC:TIM:TIME:PREM 4

**Sequence Length - PCPCH UE - 3GPP FDD (graphical display)**

Indication of the sequence length.

This indication allows the user to check if the sequence period fits into the set ARB sequence length.

In **PCPCH only - Preamble** mode, the sequence period is defined by settings **Start Offset**, **Time Pre - Pre** and **Preamble Repetition**:

Sequence Length = Start Offset (Slots) + Preamble Repetition x Time Pre - Pre

**Example:**

Start Offset = 2 access slots = 4 slots

Preamble Repetition = 3

Time Pre - Pre = 3 access slots = 6 slots

Sequence length = 4 slots + 3 x 6 slots = 22 slots

In **PCPCH only - Standard** mode, the sequence period is defined by settings **Start Offset**, **Time Pre - Pre**, **Time Pre - Pre**, **Message Part Length** and **Preamble Repetition**:

Sequence length = Start Offset (slots) + Preamble Repetition x Time Pre - Pre + Time Pre - MP + 15 x Message Part Length (frames)

**Example:**

Start Offset = 2 access slots = 4 slots

Preamble Repetition = 3

Time Pre - Pre = Time Pre - MP = 3 access slots = 6 slots

Power Control Preamble Length = 8 slots

Message Part Length = 2 frames

Sequence length = 4 slots + 3 x 6 slots + 6 slots + 8 + 15 x 2 = 66 slots

**Note:**

*In PCPCH mode the CD preamble has to be taken into account. Therefore, Preamble Repetition instead of (Preamble Repetition - 1) is used.*

Remote-control command:

SOUR:BB:W3GP:MST2:PCPC:TIM:SPER?

**ARB Sequence Length - PCPCH UE - 3GPP FDD (graphical display)**

Indication of the ARB sequence length.

This indication allows the user to check if the sequence period fits into the set ARB sequence length.

Remote-control command:

SOUR:BB:W3GP:SLEN?



The **Preamble Settings** section is where the settings for the preamble are available.

**Preamble Power - PCPCH UE - 3GPP FDD** Sets the power of the preamble component of the PCPCH channel.

Remote-control command:  
 SOUR:BB:W3GP:MST2:PCPC:PPOW -5

**Preamble Repetition - PCPCH UE - 3GPP FDD** Sets the preamble count.

Remote-control command:  
 SOUR:BB:W3GP:MST2:PCPC:PREP 3

**Preamble Power Step - PCPCH UE - 3GPP FDD** Sets the power by which the preamble is increased from repetition to repetition. The power set under **Preamble Power** is the "target power", used during the last repetition of the preamble.

**Example:**

**Preamble Power** 0 dB  
**Preamble Repetition** 3  
**Preamble Power Step** 3 dB

Generated power sequence:

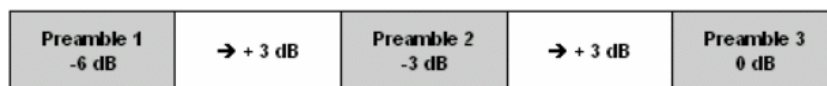

Remote-control command:  
 SOUR:BB:W3GP:MST2:PCPC:PPOW:STEP 10 dB

**Power Control Preamble Length - PCPCH UE - 3GPP FDD** Sets the length of the power control preamble in slots.

Remote-control command:  
 SOUR:BB:W3GP:MST2:PCPC:PLEN S0 | S8

**Signature - PCPCH UE - 3GPP FDD** Selects the signature to be used for the PCPCH channel. The signature defines the code domain for the channelization code being used.

Remote-control command:  
 SOUR:BB:W3GP:MST2:PCPC:SIGN 1

The **Message Part** section is where the settings for the data part of the PCPCH are available. This section is only available when **PCPCH only - Standard** is selected.

**Data Power - PCPCH UE - 3GPP FDD** Sets the power of the data component of the PCPCH channel.

Remote-control command:  
 SOUR:BB:W3GP:MST2:PCPC:DPOW -3

- Control Power - PCPCH UE - 3GPP FDD** Sets the power of the control component of the PCPCH channel.  
Remote-control command:  
SOUR:BB:W3GP:MST2:PCPC:CPOW -3
- Message Length - PCPCH UE - 3GPP FDD** Sets the length of the message component of the PCPCH channel in frames.  
Remote-control command:  
SOUR:BB:W3GP:MST2:PCPC:MLEN 2
- Slot Format - PCPCH UE - 3GPP FDD** Selects the slot format of the control component of the PCPCH channel.  
Slot formats 0 to 2 are available for the PCPCH channel. The slot format defines the structure of the control component, the FBI mode.  
**Slot format 0:** no FBI field  
**Slot format 1:** 1 FBI field  
**Slot format 2:** 2 FBI fields  
When channel coding is active, the FBI mode and the slot format are prescribed.  
Remote-control command:  
SOUR:BB:W3GP:MST2:PCPC:CPSF 1
- FBI Mode - PCPCH UE - 3GPP FDD** Selects the FBI (Feed Back Information ) mode.  
**FBI Off:** The FBI field is not in use.  
**FBI On 1 Bit:** The FBI field is used with a length of 1 bit.  
**FBI On 2 Bit:**The FBI field is used with a length of 2 bits.  
The FBI mode is determined by the slot format set. A change in the FBI mode leads automatically to an adjustment of the slot format.  
Remote-control command:  
SOUR:BB:W3GP:MST2:PCPC:FBI:MODE OFF
- FBI Pattern - PCPCH UE - 3GPP FDD** Enters the bit pattern for the FBI field in the control part (of the message part) of the PCPCH.  
The FBI field is filled cyclically with a pattern of up to 32 bits in length.  
Remote-control command:  
SOUR:BB:W3GP:MST2:PCPC:FBI:PATT H3F, 8
- Symbol Rate - PCPCH UE - 3GPP FDD** Sets the symbol rate of the PCPCH channel.  
The symbol rate is determined by the slot format set. A change in the symbol rate leads automatically to an adjustment of the slot format.  
When channel coding is active, the symbol rate is prescribed.  
Remote-control command:  
SOUR:BB:W3GP:MST2:PCPC:SRAT D15K

**Data Source - PCPCH UE -  
3GPP FDD**

Selects the data source for the data component of the PCPCH channel.

The following data sources are available for selection:

**All 0**

0 data and 1 data is generated internally.

**All 1**

Remote-control command:

```
SOUR:BB:W3GP:MST2:PCPC:DATA ZERO |
ONE
```

**PN xx**

PRBS data as per CCITT with period lengths between  $2^9-1$  and  $2^{23}-1$  is generated internally.

Remote-control command:

```
SOUR:BB:W3GP:MST2:PCPC:DATA PN9
```

**Pattern  
Pattern**

A user-definable bit pattern with a maximum length of 64 bits is generated internally.

The bit pattern is defined in the **Pattern** entry field.

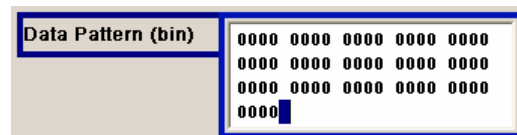

Remote-control command:

```
SOUR:BB:W3GP:MST2:PCPC:DATA PATT
SOUR:BB:W3GP:MST2:PCPC:DATA:PATT
#H3F,8
```

**Data List  
Select Data  
List**

Internal data from a programmable data list generated with the Data Editor or externally, is used.

Data lists are selected in the **File Select** window, which is called by means of the **Select Data List** button.



The **File Manager** is used to transmit external data lists to the R&S Vector Signal Generator, and can be called within every **File Select** window by means of the **File Manager** button.

Remote-control command:

```
SOUR:BB:W3GP:MST2:PCPC:DATA DLIS
SOUR:BB:W3GP:MST2:PCPC:DATA:DSEL
"pcd"
```

**TFCI - PCPCH UE - 3GPP FDD**

Enters the value of the TFCI field (Transport Format Combination Indicator) in the control component of the PCPCH channel.

Remote-control command:

```
SOUR:BB:W3GP:MST2:PCPC:TFCI 2
```

**TPC Data Source - PCPCH UE - 3GPP FDD**

Defines the data source for the TPC field of the PCPCH channel.

During data list selection the **Select TPC Data List...** button appears for selecting a data list.



During pattern selection, the **TPC Pattern** entry window is displayed.



Remote-control command:

```
SOUR:BB:W3GP:MST2:PCPC:TPC:DATA ALL0
```

```
SOUR:BB:W3GP:MST2:PCPC:TPC:DATA DLIS
```

```
SOUR:BB:W3GP:MST2:PCPC:TPC:DATA:DSEL 'TPC_PCPC1'
```

```
SOUR:BB:W3GP:MST2:PCPC:TPC:DATA PATT
```

```
SOUR:BB:W3GP:MST2:PCPC:TPC:DATA:PATT #H3F,8
```

**TPC Read Out Mode - PCPCH UE - 3GPP FDD**

Defines the TPC data usage.

With 3GPP, the TPC bits are used to signal the increase or reduction in transmit power to the called station. With all read out modes, one bit is taken from the data stream for the TPC field for each slot and entered into the bit stream several times (depending on the symbol rate). The difference between the modes lies in the usage of the TPC bits.

**Continuous:** The TPC bits are used cyclically.

Remote-control command:

```
SOUR:BB:W3GP:MST2:PCPC:TPC:READ CONT
```

**Single + All 0** The TPC bits are used once, and then the TPC sequence is continued with 0 bits.

Remote-control commands:

```
SOUR:BB:W3GP:MST2:PCPC:TPC:READ S0A
```

**Single + All 1** The TPC bits are used once, and then the TPC sequence is continued with 1 bits.

Remote-control command:

```
SOUR:BB:W3GP:MST2:PCPC:TPC:READ S1A
```

**Single + alt. 01** The TPC bits are used once and then the TPC sequence is continued with 0 and 1 bits alternately (in multiples, depending on by the symbol rate, for example, 00001111).

Remote-control command:  
 SOUR:BB:W3GP:MST2:PCPC:TPC:READ S01A

**Single + alt. 10** The TPC bits are used once and then the TPC sequence is continued with 1 and 0 bits alternately (in multiples, depending on by the symbol rate, for example, 11110000).

Remote-control command:  
 SOUR:BB:W3GP:MST2:PCPC:TPC:READ S10A

## Channel Coding - PCPCH UE1 - 3GPP FDD

The **Channel Coding** section is where the channel coding for the PCPCH channel is activated and deactivated and the coding type is defined. Use **Show Coding>>>** to display the fixed settings for the channel coding parameters.

Channel coding of PCPCH is only possible for the enhanced channel of UE1.

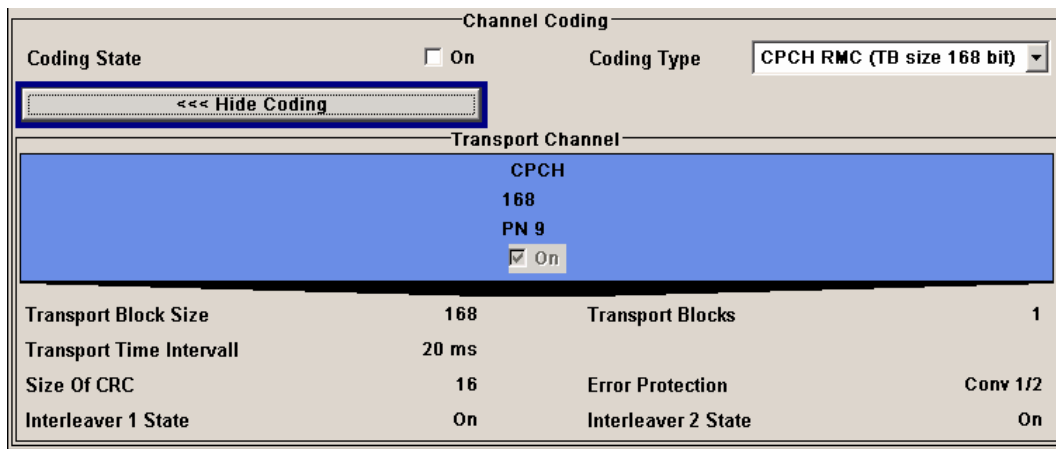

### Channel Coding State - PCPCH UE1 - 3GPP FDD

Activates or deactivates channel coding for the PCPCH channel.

Remote-control command:  
 SOUR:BB:W3GP:MST:ENH:PCPC:CCOD:STAT ON

<b>Channel Coding Type - PCPCH UE1 - 3GPP FDD</b>	<p>Selects the predefined reference measurement channel coding types for the PCPCH channel. Available for selection are:</p> <p>CPCH RMC (TB size 168 bit)</p> <p>CPCH RMC (TB size 360 bit)</p> <p>Remote-control command:  SOUR:BB:W3GP:MST:ENH:PCPC:CCOD:TYPE TB360</p>
<b>Show Coding - PCPCH UE1 - 3GPP FDD</b>	<p>Calls the menu for displaying channel coding. The reference measurement channel parameters are set to fixed values.</p> <p>Remote-control command: -</p> <p>The following parameters are displayed:</p>
<b>Data Source</b>	The data source is displayed in the transport channel graphical display.
<b>Transport Block Size</b>	Size of the transport block at the channel coding input.
<b>Transport Block</b>	Transport block count.
<b>Transport Time Interval</b>	Number of frames into which a TCH is divided.
<b>Size of CRC</b>	CRC type (length).
<b>Error Protection</b>	Error protection.
<b>Interleaver 1 / 2 State</b>	Channel coding interleaver state

## DPCCH Settings - UE - 3GPP FDD

The **DPCCH Settings** section is where the settings are made for the DPCCH channel. This section is only available if **DPCCH + DPDCH** mode is activated (see also Section "[DPDCH Settings - UE - 3GPP FDD](#)", Page 4.454).

When user equipment 1 (UE1) is selected, the signal is generated in realtime (realtime; enhanced). All the channels (DPCCH + 6 DPDCH) can be generated simultaneously in realtime.

At the physical level, an uplink DPCH consists of the DPDCH (Dedicated Physical Data Channel) and the DPCCH (Dedicated Physical Control Channel); the channel characteristics are defined by the symbol rate. The DPDCH transports the user data that is fed directly into the data field. The DPCCH transports the control fields (Pilot field; TPC = Transmit Power Control, FBI (Feedback Information) and TFCI = Transport Format Combination Indicator). DPDCH is grouped with DPCCH I/Q code multiplexing in accordance with 3GPP TS 25.211, see diagram below (the generation of an uplink reference measurement channel is described in Section "[Global Enhanced Channel Settings - UE1 - 3GPP FDD](#)", Page 4.470).

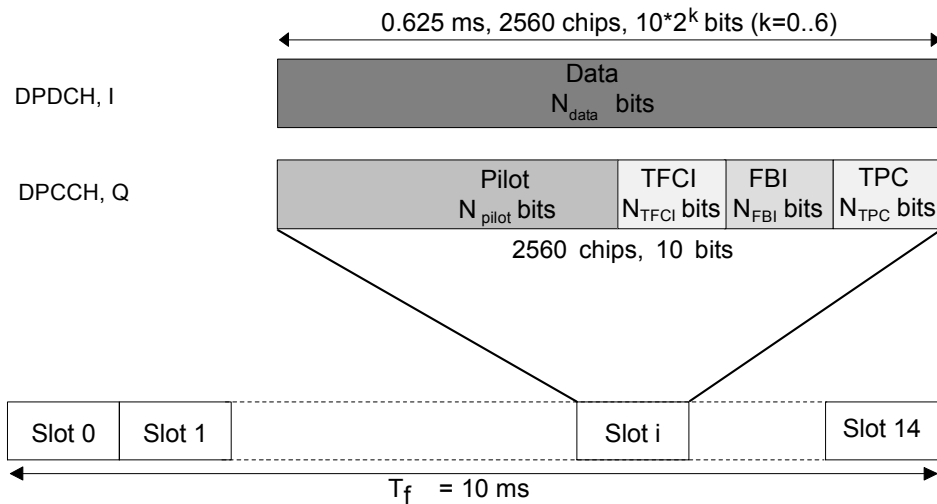
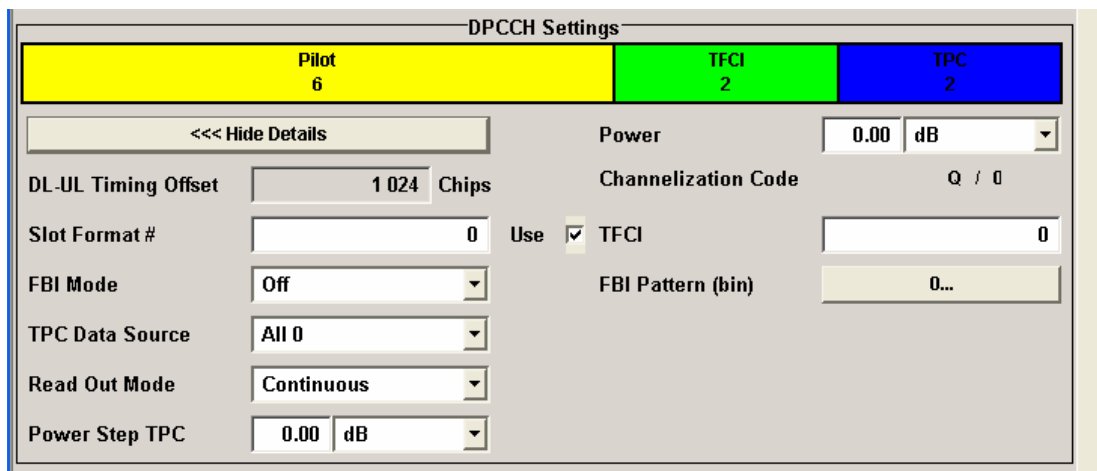

Fig. 4-37 Structure of an uplink DPCH in the time domain

In the upper section, the settings of the DPDCCH parameters are made. The channel structure is displayed.



**Channelization Code - DPCCH UE - 3GPP FDD**

Displays the channelization code and the modulation branch (I or Q) of the DPDCCH. code channel is spread with the set channelization code (spreading code). The standard assigns a fixed channelization code to the DPDCCH.

Remote-control command:  
 SOUR:BB:W3GP:MST2:DPCC:CCOD?  
 Response: "Q, 0"

**Power - DPCCH UE - 3GPP FDD**

Sets the power of the DPCCH channel.

Test cases defined in the 3GPP standard often use notation "Signalling values for  $\beta_c$  and  $\beta_d$ ". The quantization of the gain parameters is shown in the following table which is taken from 3GPP Spec 25.213 (left columns) and supplemented by the instrument-specific values (right column).

Remote-control command:

SOUR:BB:W3GP:MST2:DPCC:POW -30

Signalling values for $\beta_c$ and $\beta_d$	Quantized amplitude ratios $\beta_c$ and $\beta_d$	Power to be set for R&S Vector Signal Generator / dB
15	1.0	0.0
14	14/15	-0.60
13	13/15	-1.24
12	12/15	-1.94
11	11/15	-2.69
10	10/15	-3.52
9	9/15	-4.44
8	8/15	-5.46
7	7/15	-6.62
6	6/15	-7.96
5	5/15	-9.54
4	4/15	-11.48
3	3/15	-13.99
2	2/15	-17.52
1	1/15	-23.52
0	Switch off	Switch channel off or -80 dB

**DL-UL Timing Offset - DPCCH UE - 3GPP FDD**

Displays the timing offset between the downlink and the uplink.

The timing offset determines the time delay in chips between receipt of the downlink signal and transmission of the uplink signal.

The standard specifies this value at 1024 chips and this is taken into account automatically when generating the uplink signal. The signal is calculated synchronously to the downlink reference timing, that is to say, the first uplink frame starts at chip position 1024 of the simulated signal.

Remote-control command:

SOUR:BB:W3GP:MST2:DPCC:TOFF?

Response: 1024



**Slot Format DPCCH -  
DPCCH UE - 3GPP FDD**

Selects the slot format.

Slot formats 0 to 5 are available for the DPCCH channel. The slot format defines the FBI mode and the TFCI status.

**Slot format 0:** no FBI field / TFCI on

**Slot format 1:** no FBI field / TFCI off

**Slot format 2:** 1 FBI field / TFCI on

**Slot format 3:** 1 FBI field / TFCI off

**Slot format 4:** 2 FBI field / TFCI off

**Slot format 5:** 2 FBI field / TFCI on

Remote-control command:

SOUR:BB:W3GP:MST2:DPCC:SFOR 4

**Use TFCI - DPCCH UE -  
3GPP FDD**

Activates the TFCI (Transport Format Combination Indicator) field.

The status of the TFCI field is determined by the slot format set. A change leads automatically to an adjustment of the slot format.

Remote-control command:

SOUR:BB:W3GP:MST2:DPCC:TFCI:STAT ON | OFF

**TFCI - DPCCH UE - 3GPP  
FDD**

Enters the value of the TFCI field (Transport Format Combination Indicator) of the DPCCH channel.

Remote-control command:

SOUR:BB:W3GP:MST2:DPCC:TFCI 2

**FBI Mode - DPCCH UE -  
3GPP FDD**

Selects the FBI (Feed Back Information ) mode.

**FBI Off:** The FBI field is not in use.

**FBI On 1 Bit:** The FBI field is used with a length of 1 bit.

**FBI On 2 Bit:** The FBI field is used with a length of 2 bits.

The FBI mode is determined by the slot format set. A change in the FBI mode leads automatically to an adjustment of the slot format.

Remote-control command:

SOUR:BB:W3GP:MST2:DPCC:FBI:MODE D1B

**FBI Pattern - DPCCH UE -  
3GPP FDD**

Enters the bit pattern for the FBI field.

The FBI field is filled cyclically with a pattern of up to 32 bits in length.

Remote-control command:

SOUR:BB:W3GP:MST2:DPCC:FBI:PATT #H3F, 8

**TPC Data Source - DPCCH  
UE - 3GPP FDD**

Defines the data source for the TPC field of the DPCCH channel.

When **Pattern** is selected, an entry field appears for the bit pattern. The maximum bit pattern length is 64 bits.

When **Data List** is selected, a button appears for calling the **File Select** window for selection of a data list.

Remote-control command:

```
SOUR:BB:W3GP:MST2:DPCC:TPC:DATA ZERO | ONE
```

```
SOUR:BB:W3GP:MST2:DPCC:TPC:DATA PATT
```

```
SOUR:BB:W3GP:MST2:DPCC:TPC:DATA:PATT #H3F,8
```

```
SOUR:BB:W3GP:MST2:DPCC:TPC:DATA DLIS
```

```
SOUR:BB:W3GP:MST2:DPCC:TPC:DATA:DSEL 'dpcc_data'
```

**TPC Read Out Mode -  
DPCCH UE - 3GPP FDD**

Defines the TPC data usage.

With 3GPP, the TPC bits are used to signal the increase or reduction in transmit power to the called station. With all read out modes, one bit is taken from the data stream for the TPC field for each slot and entered into the bit stream several times (depending on the symbol rate). The difference between the modes lies in the usage of the TPC bits.

These different modes can be used, for example, to deliberately set a DPCH of a base station to a specific output power (e.g. with the pattern 11111) and then let it oscillate around this power (with Single + alt. 01 and Single + alt. 10). This then allows power measurements to be carried out at the base station (at a quasi-constant power). Together with the option (Mis-)Use TPC for output power control (see below), TPC Read Out Mode can also be used to generate various output power profiles.

**Continuous:** The TPC bits are used cyclically.

Remote-control command:

```
SOUR:BB:W3GP:MST2:DPCC:TPC:READ CONT
```

**Single + All 0** The TPC bits are used once, and then the TPC sequence is continued with 0 bits.

Remote-control command:

```
SOUR:BB:W3GP:MST2:DPCC:TPC:READ S0A
```

**Single + All 1** The TPC bits are used once, and then the TPC sequence is continued with 1 bits.

Remote-control command:

```
SOUR:BB:W3GP:MST2:DPCC:TPC:READ S1A
```

**Single + alt. 01** The TPC bits are used once and then the TPC sequence is continued with 0 and 1 bits alternately (in multiples, depending on by the symbol rate, for example, 00001111).

Remote-control command:

```
SOUR:BB:W3GP:MST2:DPCC:TPC:READ S01A
```

**Single + alt. 10** The TPC bits are used once and then the TPC sequence is continued with 1 and 0 bits alternately (in multiples, depending on by the symbol rate, for example, 11110000).

Remote-control command:

```
SOUR:BB:W3GP:MST2:DPCC:TPC:READ S10A
```

### Misuse TPC for Output Power Control - DPCCH UE - 3GPP FDD

**(This feature is available for UE2, UE3, and UE4 only.)**

Defines "mis-" use of the TPC data.

With 3GPP, the TPC bits are used to signal the increase or reduction in transmit power to the called station. If **(Mis-) use TPC for output power control** is activated, the specified pattern is misused, in order to vary the intrinsic transmit power over time. A bit of this pattern is removed for each slot in order to increase (bit = "1") or reduce (bit = "0") the channel power by the specified power step (**Power Step**). The upper limit for this is 0 dB and the lower limit -80 dB. The following envelope is produced at a channel power of 0 dB, power step 1.0 dB and pattern "001110100000011" and TPC Pattern ReadOut Mode **Continuous**:

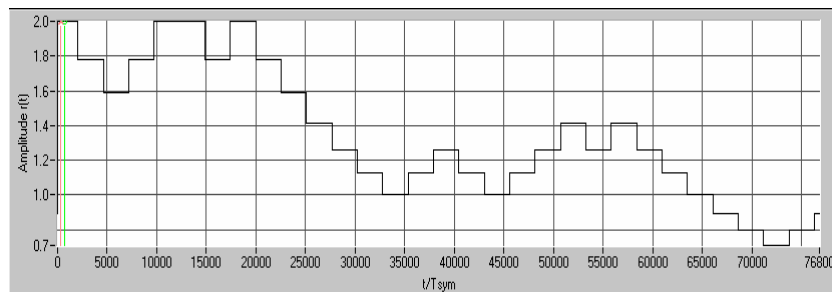

Fig. 4-38 Dynamic change of channel power (continuous)

#### Note:

*Power control works both on the DPCCH and all the active DPCHs.*

*The change in power is always carried out (as stipulated in the standard) at the start of the slot pilot field*

Remote-control command:

```
SOUR:BB:W3GP:MST2:DPCC:TPC:MIS ON
```

**TPC Power Step - DPCCH  
UE - 3GPP FDD****(This feature is available for UE2, UE3, and UE4 only.)**Sets the step width of the power change in dB for **(Mis-) use TPC for output power control**.

Remote-control command:

SOUR:BB:W3GP:MST2:DPCC:TPC:PST 1.0

**E-DPCCH Settings - UE - 3GPP FDD**

The **E-DPCCH Settings** section is where the settings are made for the E-DPCCH channel. This section is only available if **DPCCH + DPDCH** mode is activated (see also Section "[DPDCH Settings - UE - 3GPP FDD](#)", Page 4.454).

In the upper section, the settings of the DPCCH parameters are made. The channel structure is displayed.

**State – E-DPCCH UE -  
3GPP FDD**

Activates or deactivates the E-DPCCH channel.

If an FRC is set for the channel, this field is activated automatically.

Remote-control command:

SOUR:BB:W3GP:MST1:HSUP:DPCC:E:STAT ON

**Power – E-DPCCH UE -  
3GPP FDD**

Sets the power of the E-DPCCH channel.

The value range is -80 dB to 0 dB.

Remote-control command:

SOUR:BB:W3GP:MST:HSUP:DPCC:E:POW -2.5dB

**Channelization Code – E-  
DPCCH UE - 3GPP FDD**

Displays the channelization code and the modulation branch (always I) of the E-DPCCH. The code channel is spread with the set channelization code (spreading code). The standard assigns a fixed channelization code to the E-DPCCH.

Remote-control command:

SOUR:BB:W3GP:MST1:DPCC:HS:CCOD?

Response: "I, 0"

- Retrans Sequence Number – E-DPCCH UE - 3GPP FDD** Sets the retransmission sequence number.  
The value range is 0 to 3.  
Remote-control command:  
SOUR:BB:W3GP:MST1:HSUP:DPCC:E:RSN 2
- E-TFCI Information – E-DPCCH UE - 3GPP FDD** Sets the value for the TFCI (Transport Format Combination Indicator) field.  
The value range is 0 to 127  
Remote-control command:  
SOUR:BB:W3GP:MST1:HSUP:DPCC:E:TFCI 5
- Happy Bit – E-DPCCH UE - 3GPP FDD** Activating the happy bit. This bit is indicating whether the UE could use more resources (Not Happy/deactivated) or not (Happy/activated).  
Remote-control command:  
SOUR:BB:W3GP:MST1:HSUP:DPCC:E:HBIT ON
- E-DCH TTI – E-DPCCH UE - 3GPP FDD** Sets the value for the TTI (Transmission Time Interval).  
If an FRC is set for the channel, this field is read-only.  
Remote-control command:  
SOUR:BB:W3GP:MST1:HSUP:DPCC:E:TTIE 2
- Use (DTX) – E-DPCCH UE - 3GPP FDD** Activates or deactivates the DTX (Discontinuous Transmission) mode.  
If an FRC is set for the channel, this field is read-only.  
Remote-control command:  
SOUR:BB:W3GP:MST1:HSUP:DPCC:E:DTX:STAT ON
- DTX Pattern (bin) – E-DPCCH UE - 3GPP FDD** Sets the bit pattern for the DTX. The maximum length is 64 bits.  
The following values are allowed:  
1: Data transmission  
-: DTX  
Remote-control command:  
SOUR:BB:W3GP:MST1:HSUP:DPCC:E:DTX:PATT "11-1-"
- HSUPA FRC... - E-DPCCH UE - 3GPP FDD** **(This button is available for UE1 only).**  
Calls the menu for configuring the FRC (Fixed Reference Channel).  
Remote-control command: n.a.

# HS-DPCCH Settings - UE - 3GPP FDD

The **HS-DPCCH Settings** section is where the settings are made for the high speed channel. This section is only available if **DPCCH + DPDCH** mode is activated (see also Sections "*DPCCCH Settings - UE - 3GPP FDD*", Page 4.442 and "*DPDCH Settings - UE - 3GPP FDD*", Page 4.454).

When user equipment 1 (UE1) is selected, the signal is generated in realtime.

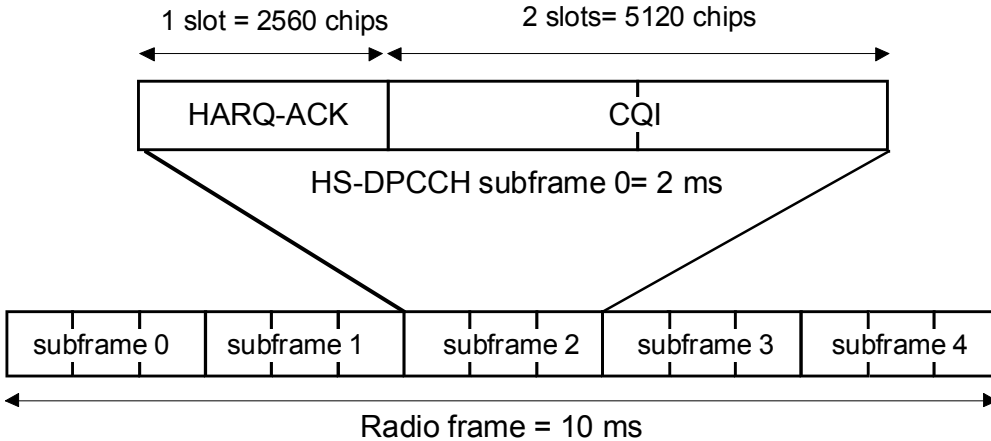

Fig. 4-39 Structure of an uplink HS-DPCCH in the time domain

The HS-DPCCH carries uplink feedback signalling related to the accuracy and quality of downlink HS-DSCH transmission. (Hybrid-ARQ Acknowledgement (HARQ-ACK) in the first subframe slot and Channel-Quality Indication (CQI) in the second and third subframe slot). Only one HS-DPCCH may be transmitted on each radio link. The HS-DPCCH can only exist together with an uplink DPCCH.

The HS-DPCCH subframe starts  $256 \times m$  chips after the start of an uplink DPCCH slot with  $m$  selected such that the subframe transmission starts within the first 0-255 chips after 7.5 slots following the end of the received HS-PDSCH sub-frame.

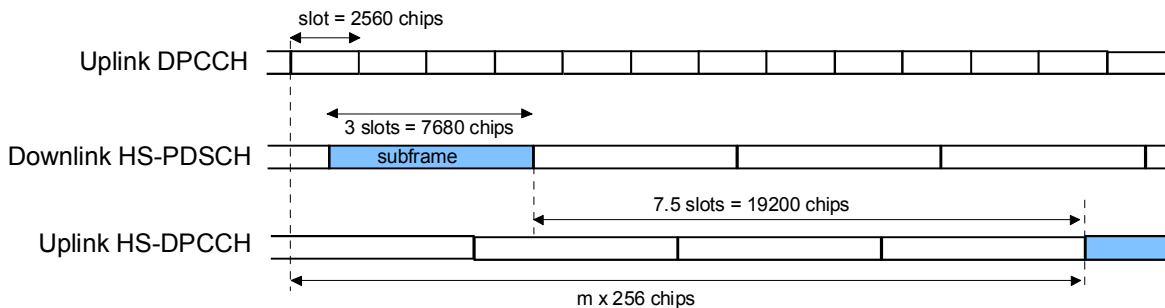

Fig. 4-40 Timing offset between the uplink DPCCH, the HS-PDSCH and the HS-DPCCH at the UE.

In the mid section, the settings of the HS-DPCCH parameters are made. The channel structure is displayed.

#### State - HS-DPCCH - UE - 3GPP FDD

Activates or deactivates the HS-DPCCH channel.

Remote-control command:

SOUR:BB:W3GP:MST2:DPCC:HS:STAT ON

#### Channel Power - HS-DPCCH - UE - 3GPP FDD

Sets the channel power in dB.

The power entered is relative to the powers of the other channels and does not initially relate to the LEVEL power display. If **Adjust Total Power** is executed (top level of the 3GPP FDD menu), all the power data is relative to LEVEL.

#### Note:

*The uplink high speed channel is blanked (duty cycle 3/15).*

Remote-control command:

SOUR:BB:W3GP:MST2:DPCC:HS:POW -30

#### Channelization Code - HS-DPCCH - UE - 3GPP FDD

Displays the channelization code and the modulation branch (I or Q) of the HS-DPCCH. The code channel is spread with the set channelization code (spreading code). The channelization code of the high speed channel depends on the number of activated DPDCCHs, i.e. on the overall symbol rate.

Remote-control command:

SOUR:BB:W3GP:MST1:DPCC:HS:CCOD?

Response: "Q, 32"

**Start Delay - HS-DPCCH - UE - 3GPP FDD**

Sets the delay between the uplink HS-DPCCH and the frame of uplink DPCH.

Thus, the channel can be synchronized with the associated downlink PDSCH.

The delay is entered as a multiple  $m$  of 256 chips according to TS 25.211 7.7:

$$m = (T_{TX\_diff} / 256) + 101$$

where  $T_{TX\_diff}$  is the difference in chips ( $T_{TX\_diff} = 0, 256, \dots, 38144$ ).

The value range of  $m$  is 0 to 250 (2 frames +1024 chips)

Remote-control command:

SOUR:BB:W3GP:MST2:DPCC:HS:SDEL 101

**Inter TTI Distance - HS-DPCCH - UE - 3GPP FDD**

Selects the distance between two HSDPA packets. The distance is set in number of sub-frames (3 slots = 2 ms). An **Inter TTI Distance** of 1 means continuous generation.

Remote-control command:

SOUR:BB:W3GP:MST2:DPCC:HS:TTID 4

**HARQ-ACK Pattern - HS-DPCCH - UE - 3GPP FDD**

Enters the pattern for the HARQ-ACK field (Hybrid-ARQ Acknowledgement). After receiving a transmission packet feedback information unrelated to the accuracy of downlink HS-DSCH transmission.

Remote-control command:

SOUR:BB:W3GP:MST2:DPCC:HS:HAP "1110--0-0-111"

**"1" = ACK**

The HARQ ACK is sent. Transmission was successful and correct.

**"0" = NACK**

The NACK is not sent. Transmission was not correct. With an NACK, the UE requests retransmission of the incorrect data.

**"-" = DTX**

Nothing is sent. Transmission is interrupted (Discontinuous Transmission (DTX)).

**Power Offset ACK - HS-DPCCH - UE - 3GPP FDD**

Sets the channel power part of the ACK in dB.

The value range is -10 dB to 10 dB.

Remote-control command:

SOUR:BB:W3GP:MST2:DPCC:HS:POAC 1.5dB



**Power Offset NACK - HS-DPCCH - UE - 3GPP FDD**

Sets the channel power part of the NACK in dB.

The value range is -10 dB to 10 dB.

Remote-control command:

```
SOUR:BB:W3GP:MST2:DPCC:HS:PONA 1.5dB
```

**CQI Length - HS-DPCCH - UE - 3GPP FDD**

Sets the length of the CQI sequence. The values of the CQI sequence are entered in input fields **CQI Values**. The pattern is generated cyclically.

With the CQI (Channel Quality Indicator), the user equipment informs the base station about the receive quality of the downlink HS-PDSCH.

Thus, the base station can adapt the modulation and coding scheme to improve the signal quality. The R&S Vector Signal Generator supports the control of the base station HS-PDSCH by CQI sequences with a length of 1 to 10 values.

Remote-control command:

```
SOUR:BB:W3GP:MST2:DPCC:HS:CQI:PLEN 4
```

**CQI Values - HS-DPCCH - UE - 3GPP FDD**

Enters the values of the CQI sequence. Value -1 means that no CQI is sent (DTX).

The length of the CQI sequence is set at input field **CQI Length**. The pattern is generated cyclically.

With the CQI (Channel Quality Indicator), the user equipment informs the base station about the receive quality of the downlink HS-PDSCH. Thus, the base station can adapt the modulation and coding scheme to improve the signal quality. The R&S Vector Signal Generator supports the control of the base station HS-PDSCH by CQI sequences with a length of 1 to 10 values.

Remote-control command:

```
SOUR:BB:W3GP:MST2:DPCC:HS:CQI1:VAL 4
```

## DPDCH Settings - UE - 3GPP FDD

The **DPDCH Settings** section is where the settings are made for the DPDCH channels. This section is only available if **DPCCH + DPDCH** mode is activated (see also Section "[DPCCH Settings - UE - 3GPP FDD](#)", Page 4.442).

The **Channel Table** section is where the channel table for the DPDCH channels is displayed. The number of active channels depends on the overall symbol rate set. The data sources for the data part of the individual channels can be selected in the channel table. The remaining parameters are only displayed and their value depends on the overall symbol rate set (see [Table 4-22 Structure of the DPDCH channel table in conjunction with the overall symbol rate](#))

When UE1 is selected, the signal is generated in realtime (realtime; enhanced). All the channels (DPCCH + 6 DPDCH) can be generated simultaneously in realtime. The **Global Enhanced Channels...** button leads to a sub-menu for configuring the enhanced parameters.

	1	2	3	4	5	6
Channel Type	DPDCH	DPDCH	DPDCH	DPDCH	DPDCH	DPDCH
Symbol Rate / State	60	Off	Off	Off	Off	Off
ChannelizationCode	1 / 16					
DPDCH Data Source	PN 9					
DPDCH Pattern	0					
DPDCH Data List	None					
DCCH Data Source		Channel	Coding	Off		
DCCH Pattern						
DCCH Data List						

### State - DPDCH UE - 3GPP FDD

Activates or deactivates all the DPDCH channels

Remote-control command:

SOUR:BB:W3GP:MST2:DPDC:STAT ON

**Channel Power - DPDCH  
UE - 3GPP FDD**

Sets the channel power in dB.

The power entered is relative to the powers of the other channels and does not initially relate to the LEVEL power display. If **Adjust Total Power** is executed (top level of the 3GPP FDD menu), all the power data is relative to LEVEL.

**Note:**

*The uplink channels are not blanked in this mode (duty cycle 100%).*

Test cases defined in the 3GPP standard often use notation "Signalling values for  $\beta_c$  and  $\beta_d$ ". The quantization of the gain parameters is shown in the following table which is taken from 3GPP Spec 25.213 (left columns) and supplemented by the instrument-specific values (right column).

Remote-control command:

SOUR:BB:W3GP:MST2:DPDC:POW -30

Signalling values for $\beta_c$ and $\beta_d$	Quantized amplitude ratios $\beta_c$ and $\beta_d$	Power to be set for R&S Vector Signal Generator / dB
15	1.0	0.0
14	14/15	-0.60
13	13/15	-1.24
12	12/15	-1.94
11	11/15	-2.69
10	10/15	-3.52
9	9/15	-4.44
8	8/15	-5.46
7	7/15	-6.62
6	6/15	-7.96
5	5/15	-9.54
4	4/15	-11.48
3	3/15	-13.99
2	2/15	-17.52
1	1/15	-23.52
0	Switch off	Switch channel off or -80 dB

**Force Channelization Code to I/Q- DPDCH UE - 3GPP FDD**

Sets the channelization code to I/O.

This mode can only be activated if the overall symbol rate is  $< 2 \times 960$  kbps.

It is provided for test purposes. Using an oscilloscope, the control and data bits of the DPDCH are visible on the I/Q signal if

- Force Channelization Code to I/O is On
- Scrambling Code Mode is set to Off.
- DPCCH power is - 80 dB

Remote-control command:

SOUR:BB:W3GP:MST2:DPDC:FCIO ON

**Overall Symbol Rate -  
DPDCH UE - 3GPP FDD**

Sets the overall symbol rate of all the DPDCH channels.

The structure of the DPDCH channel table depends on this parameter. The overall symbol rate determines which DPDCHs are active, which symbol rate they have and which channelization codes they use (see Table below).

DPDCHs that are not active by virtue of the overall rate, are also disabled for operation.

**Note:**

*Up to an overall rate of 960 ksps, only DPDCH 1 is active, its symbol rate is the same as the overall symbol rate and the channelization code is the same as spreading factor/4 (spreading factor = chip rate / symbol rate). With an overall symbol rate greater than 960 ksps, all the active DPDCH channels have the symbol rate 960 ksps.*

Remote-control command:

SOUR:BB:W3GP:MST2:DPDC:ORAT D60K

Table 4-22 Structure of the DPDCH channel table in conjunction with the overall symbol rate

Overall Symbol Rate	DPDCH 1	DPDCH 2	DPDCH 3	DPDCH 4	DPDCH 5	DPDCH 6
I or Q branch	I	Q	I	Q	I	Q
15 ksps	State: ON S-Rate: 15 k Ch. Code: 64	State: OFF	State: OFF	State: OFF	State: OFF	State: OFF
30 ksps	State: ON S-Rate: 30 k Ch. Code: 32	State: OFF	State: OFF	State: OFF	State: OFF	State: OFF
60 ksps	State: ON S-Rate: 60 k Ch. Code: 16	State: OFF	State: OFF	State: OFF	State: OFF	State: OFF
120 ksps	State: ON S-Rate: 120 k Ch. Code: 8	State: OFF	State: OFF	State: OFF	State: OFF	State: OFF
240 ksps	State: ON S-Rate: 240 k Ch. Code: 4	State: OFF	State: OFF	State: OFF	State: OFF	State: OFF
480 ksps	State: ON S-Rate: 480 k Ch. Code: 2	State: OFF	State: OFF	State: OFF	State: OFF	State: OFF
960 ksps	State: ON S-Rate: 960 k Ch. Code: 1	State: OFF	State: OFF	State: OFF	State: OFF	State: OFF
2 x 960 ksps	State: ON S-Rate: 960 k Ch. Code: 1	State: ON S-Rate: 960 k Ch. Code: 1	State: OFF	State: OFF	State: OFF	State: OFF
3 x 960 ksps	State: ON S-Rate: 960 k Ch. Code: 1	State: ON S-Rate: 960 k Ch. Code: 1	State: ON S-Rate: 960 k Ch. Code: 3	State: OFF	State: OFF	State: OFF
4 x 960 ksps	State: ON S-Rate: 960 k	State: ON S-Rate: 960	State: ON S-Rate: 960	State: ON S-Rate: 960	State: OFF	State: OFF

Overall Rate	Symbol	DPDCH 1	DPDCH 2	DPDCH 3	DPDCH 4	DPDCH 5	DPDCH 6
		Ch. Code: 1	k Ch. Code: 1	k Ch. Code: 3	k Ch. Code: 3		
5 x 960 ksps		State: ON S-Rate: 960 k Ch. Code: 1	State: ON S-Rate: 960 k Ch. Code: 1	State: ON S-Rate: 960 k Ch. Code: 3	State: ON S-Rate: 960 k Ch. Code: 3	State: ON S-Rate: 960 k Ch. Code: 2	State: OFF
6 x 960 ksps		State: ON S-Rate: 960 k Ch. Code: 1	State: ON S-Rate: 960 k Ch. Code: 1	State: ON S-Rate: 960 k Ch. Code: 3	State: ON S-Rate: 960 k Ch. Code: 3	State: ON S-Rate: 960 k Ch. Code: 2	State: ON S-Rate: 960 k Ch. Code: 2

**Global Enhanced Channels... - DPDCH UE - 3GPP FDD**

Calls the menu for configuring all the enhanced channel settings of user equipment UE1.

The menu is described in Section "[Global Enhanced Channel Settings - UE1 - 3GPP FDD](#)".

Remote-control command: n.a.

## Channel Table- DPDCH UE - 3GPP FDD

The **Channel Table** section is where the channel table for the DPDCH channels is displayed. The number of active channels depends on the overall symbol rate set. The data sources for the data part of the individual channels can be selected in the channel table. The remaining parameters are only displayed and their value depends on the overall symbol rate set (see [Table 4-22](#) *Structure of the DPDCH channel table in conjunction with the overall symbol rate*).

<b>Channel Type - DPDCH Channel UE - 3GPP FDD</b>	<p>Displays the channel type.</p> <p>Remote-control command: n.a.</p>
<b>Channel Number - DPDCH Channel UE - 3GPP FDD</b>	<p>Displays the channel number.</p> <p>Remote-control command: n.a. (the channel is selected by the suffix at keyword CHANnel&lt;n&gt;)</p>
<b>Symbol Rate - DPDCH Channel UE - 3GPP FDD</b>	<p>Displays the symbol rate and the state of the DCDC channel.</p> <p>The symbol rate and the state of channel 2 to 6 are dependent on the overall symbol rate set and cannot be modified.</p> <p>Remote-control command: SOUR:BB:W3GP:MST1:CHAN1:DPDC:SRAT? Response: D30k</p>
<b>Channelization Code - DPDCH Channel UE - 3GPP FDD</b>	<p>Displays the channelization code and the modulation branch (I or Q) of the DPDCH channel.</p> <p>The channelization code is dependent on the overall symbol rate set and cannot be modified.</p> <p>Remote-control command: SOUR:BB:W3GP:MST1:CHAN1:DPDC:CCOD? Response: Q, 32</p>

**DPDCH - DTCH Data -  
DPDCH Channel UE - 3GPP  
FDD**

(UE2..UE4; UE1 without channel coding)  
DPDCH / DTCH  
(UE1 with channel coding)

Selects the data source for the DPDCH channel.

When the selection is UE2 ... UE4, the data source for the DPDCH is always entered here.

The data source for the DPDCH is also entered here for the enhanced channels of UE1 without channel coding.

When channel coding is active, the data source for the DTCH1 component in the transport layer is selected here. In this situation, the display reads **DPDCH / DTCH** and the **DCCH Data** entry field is enabled for selecting the data source of the DCCH channel. The data sources of the other DTCH channels can be set in the **Global Enhanced Channel Settings in the Transport Channel** section sub-menu, see Section "[Global Enhanced Channel Settings - UE1 - 3GPP FDD](#)", Page 4.470.

The following are available for selection as data sources:

**All 0**            0 data and 1 data is generated internally.

**All 1**            Remote-control commands:  
SOUR:BB:W3GP:MST1:HSUP:CHAN1:DPDC:E:DA  
TA ZERO | ONE

**PN xx**            PRBS data as per CCITT with period lengths  
between  $2^9-1$  and  $2^{23}-1$  is generated internally.

Remote-control commands:  
SOUR:BB:W3GP:MST1:CHAN1:DPDC:DATA PN9|  
PN15| PN16| PN20| PN21| PN23  
SOUR:BB:W3GP:MST:ENH:DPDC:TCH1:DATA  
PN9| PN15| PN16| PN20| PN21| PN23

**Pattern**            A user-definable bit pattern with a maximum length  
**Pattern**            of 64 bits is generated internally.

The bit pattern is defined in the **Pattern** entry field.



Remote-control commands:  
SOUR:BB:W3GP:MST1:HSUP:CHAN1:DPDC:E:DA  
TA:PATT #H3F, 8

**Data List**            Internal data from a programmable data list  
generated with the Data Editor or externally, is used.

Data lists are selected in the **File Select** window, which is called by means of the **Select Data List** button.



The **File Manager** is used to transmit external data lists to the R&S Vector Signal Generator, and can be called within every **File Select** window by means of the **File Manager** button.

Remote-control commands:

```
SOUR:BB:W3GP:MST1:HSUP:CHAN1:DPDC:E:DA
TA:DSEL "dp1"
```

```
SOUR:BB:W3GP:MST1:CHAN1:DPDC:DATA DLIS
SOUR:BB:W3GP:MST1:CHAN1:DPDC:DSEL
"dp1"
```

```
SOUR:BB:W3GP:MST:ENH:DPDC:TCH1:DATA
DLIS
```

```
SOUR:BB:W3GP:MST:ENH:DPDC:TCH1:DATA:DS
EL "dp"
```

### DCCH Data Source - DPDCH Channel UE - 3GPP FDD

Selects the data source for the DCCH component.

This parameter is only available for UE1 for enhanced channels with active channel coding.

The following are available for selection as data sources:

**All 0**            0 data and 1 data is generated internally.

**All 1**            Remote-control command:  
SOUR:BB:W3GP:MST1:CHAN1:DPDC:DATA:DCC  
H ALL0 | ALL1

**PN xx**            PRBS data as per CCITT with period lengths between  $2^9-1$  and  $2^{23}-1$  is generated internally.

Remote-control commands:  
SOUR:BB:W3GP:MST1:CHAN1:DPDC:DATA:DCC  
H PN9| PN15| PN16| PN20| PN21| PN23

**Pattern**            A user-definable bit pattern with a maximum length of 64 bits is generated internally.

**Pattern**

The bit pattern is defined in the **Pattern** entry field.



Remote-control command:  
SOUR:BB:W3GP:MST1:CHAN1:DPDC:DATA:DCC  
H PATT  
SOUR:BB:W3GP:MST1:CHAN1:DPDC:DATA:DCC  
H:PATT #H3F,8

**Data List**            Internal data from a programmable data list generated with the Data Editor or externally, is used.

Data lists are selected in the **File Select** window, which is called by means of the **Select Data List** button.





The **File Manager** is used to transmit external data lists to the R&S Vector Signal Generator, and can be called within every **File Select** window by means of the **File Manager** button.

Remote-control command:

```
SOUR:BB:W3GP:MST1:CHAN:DPDC:DATA:DCCH
DLIS
SOUR:BB:W3GP:MST1:CHAN:DPDC:DATA:DCCH
:DSEL 'dc1'
```

## E-DPDCH Settings - UE - 3GPP FDD

This section is only available if **DPCCH + DPDCH** mode is activated (see also Section "[DPCCH Settings - UE - 3GPP FDD](#)", Page 4.442).

The **Channel Table** section is where the channel table for the E-DPDCH channels is displayed. The number of active channels depends on the overall symbol rate set. The data sources for the data part of the individual channels can be selected in the channel table. The remaining parameters are only displayed and their value depends on the overall symbol rate set (see [Table 4-22 Structure of the DPDCH channel table in conjunction with the overall symbol rate](#)).

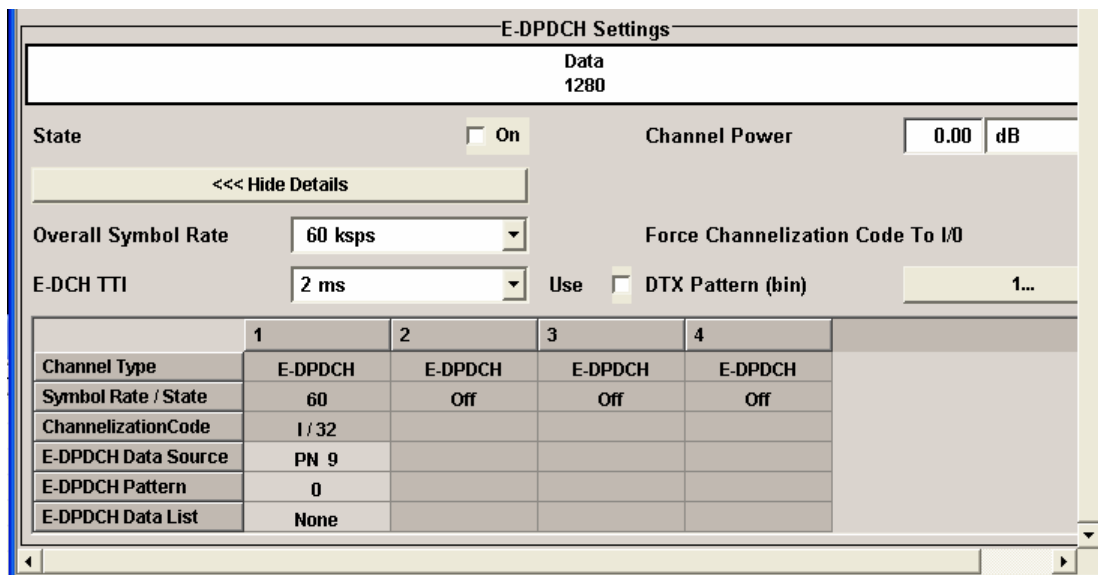

### State – E-DPDCH UE - 3GPP FDD

Activates or deactivates all the E-DPDCH channels  
If an FRC is set for the channel, this field is activated automatically.

Remote-control command:

```
SOUR:BB:W3GP:MST1:HSUP:DPDC:E:STAT ON
```

**Power – E-DPDCH UE -  
3GPP FDD**

Sets the power of the E-DPDCH channel.

The power entered is relative to the powers of the other channels and does not initially relate to the LEVEL power display. If **Adjust Total Power** is executed (top level of the 3GPP FDD menu), all the power data is relative to LEVEL.

**Note:**

*The uplink channels are not blanked in this mode (duty cycle 100%).*

*Exception: The DTX mode is set to ON.*

Remote-control command:

SOUR:BB:W3GP:MST1:HSUP:DPDC:E:POW -30

**Force Channelization Code  
To I/O – E-DPDCH UE -  
3GPP FDD**

Sets the channelization code to I/O.

This mode can only be activated if the overall symbol rate is < 2 x 960 kbps.

It is provided for test purposes. Using an oscilloscope, the control and data bits of the E-DPDCH are visible on the I/Q signal if

- Force Channelization Code to I/O is On
- Scrambling Code Mode is set to Off.
- E-DPDCH power is - 80 dB

Remote-control command:

SOUR:BB:W3GP:MST1:HSUP:DPDC:E:FCIO ON

**Overall Symbol Rate – E-  
DPDCH UE - 3GPP FDD**

Sets the overall symbol rate of all the E-DPDCH channels.

The structure of the E-DPDCH channel table depends on this parameter. The overall symbol rate determines which E-DPDCHs are active, which symbol rate they have and which channelization codes they use (see Table below).

E-DPDCHs that are not active by virtue of the overall rate, are also disabled for operation.

If an FRC is set for the channel, this field is read-only.

Remote-control command:

SOUR:BB:W3GP:MST1:HSUP:DPDC:E:ORAT D60K

**E-DCH TTI – E-DPDCH UE -  
3GPP FDD**

Sets the value for the TTI (Transmission Time Interval).

If an FRC is set for the channel, this field is read-only.

Remote-control command:

SOUR:BB:W3GP:MST1:HSUP:DPDC:E:TTIE 2ms

**Use (DTX) - DPDCH UE - 3GPP FDD**

Activates or deactivates the DTX (Discontinuous Transmission) mode.  
If an FRC is set for the channel, this field is read-only.

Remote-control command:

SOUR:BB:W3GP:MST1:HSUP:DPDCh:E:DTX:STAT ON

**DTX Pattern (bin) – E-DPDCH UE - 3GPP FDD**

Sets the bit pattern for the DTX. The maximum length is 64 bits.  
The following values are allowed:

1: Data transmission

-: DTX

Remote-control command:

SOUR:BB:W3GP:MST1:HSUP:DPDC:E:DTX:PATT "1-1-"

Table 4-23 Structure of the E-DPDCH channel table in conjunction with the overall symbol rate and no DPDCH activ

Overall Rate	Symbol	E-DPDCH 1	E-DPDCH 2	E-DPDCH 3	E-DPDCH 4
I or Q branch		I	Q	I	Q
60 ksps		State: ON S-Rate: 60 k Ch. Code: 16	State: OFF	State: OFF	State: OFF
120 ksps		State: ON S-Rate: 120 k Ch. Code: 8	State: OFF	State: OFF	State: OFF
240 ksps		State: ON S-Rate: 240 k Ch. Code: 4	State: OFF	State: OFF	State: OFF
480 ksps		State: ON S-Rate: 480 k Ch. Code: 2	State: OFF	State: OFF	State: OFF
960 ksps		State: ON S-Rate: 960 k Ch. Code: 1	State: OFF	State: OFF	State: OFF
2 x 960 ksps		State: ON S-Rate: 960 k Ch. Code: 1	State: ON S-Rate: 960 k Ch. Code: 1	State: OFF	State: OFF
2 x 1920 ksps		State: ON S-Rate: 1920 k Ch. Code: 1	State: ON S-Rate: 1920 k Ch. Code: 1	State: OFF	State: OFF
2 x 960 ksps + 2 x 1920 ksps		State: ON S-Rate: 1920 k Ch. Code: 1	State: ON S-Rate: 1920 k Ch. Code: 1	State: ON S-Rate: 960 k Ch. Code: 1	State: ON S-Rate: 960 k Ch. Code: 1

Table 4-24 Structure of the E-DPDCH channel table in conjunction with the overall symbol rate and one DPDCH activ

Overall Rate	Symbol	E-DPDCH 1	E-DPDCH 2	E-DPDCH 3	E-DPDCH 4
Activ HS-DPCCH? I or Q branch		No Q	No I	Yes I	Yes Q
60 ksps		State: ON S-Rate: 60 k Ch. Code: 32	State: OFF	State: ON S-Rate: 60 k Ch. Code: 32	State: OFF
120 ksps		State: ON S-Rate: 120 k Ch. Code: 16	State: OFF	State: ON S-Rate: 120 k Ch. Code: 16	State: OFF
240 ksps		State: ON S-Rate: 240 k Ch. Code: 8	State: OFF	State: ON S-Rate: 240 k Ch. Code: 8	State: OFF
480 ksps		State: ON S-Rate: 480 k Ch. Code: 4	State: OFF	State: ON S-Rate: 480 k Ch. Code: 4	State: OFF
960 ksps		State: ON S-Rate: 960 k Ch. Code: 2	State: OFF	State: ON S-Rate: 960 k Ch. Code: 2	State: OFF
2 x 960 ksps		State: ON S-Rate: 960 k Ch. Code: 2	State: ON S-Rate: 960 k Ch. Code: 2	State: ON S-Rate: 960 k Ch. Code: 2	State: ON S-Rate: 960 k Ch. Code: 2
2 x 1920 ksps		State: ON S-Rate: 1920 k Ch. Code: 1	State: ON S-Rate: 1920 k Ch. Code: 1	State: ON S-Rate: 1920 k Ch. Code: 1	State: ON S-Rate: 1920 k Ch. Code: 1

**Channel Table- E-DPDCH UE - 3GPP FDD**

The **Channel Table** section is where the channel table for the E-DPDCH channels is displayed. The number of active channels depends on the overall symbol rate set. The data sources for the data part of the individual channels can be selected in the channel table. The remaining parameters are only displayed and their value depends on the overall symbol rate set (see [Table 4-22 Structure of the DPDCH channel table in conjunction with the overall symbol rate](#)).

**Channel Type – E-DPDCH Channel UE - 3GPP FDD** Displays the channel type.  
Remote-control command: n.a.

**Channel Number – E-DPDCH Channel UE - 3GPP FDD** Displays the channel number.  
Remote-control command: n.a.  
(the channel is selected by the suffix at keyword CHANnel<n>)

**Symbol Rate – E-DPDCH Channel UE - 3GPP FDD**

Displays the symbol rate and the state of the E-DCDCH channel.

The symbol rate and the state of channel 2 to 6 are dependent on the overall symbol rate set and cannot be modified.

Remote-control command:

```
SOUR:BB:W3GP:MST1:HSUP:CHAN1:DPDC:E:SRAT?
```

```
Response: D30k
```

**Channelization Code – E-DPDCH Channel UE - 3GPP FDD**

Displays the channelization code and the modulation branch (I or Q) of the DPDCH channel.

The channelization code is dependent on the overall symbol rate set and cannot be modified.

Remote-control command:

```
SOUR:BB:W3GP:MST1:HSUP:CHAN1:DPDC:E:CCOD?
```

```
Response: Q, 32
```

**DPDCH Data – E-DPDCH Channel UE - 3GPP FDD**

(UE2..UE4; UE1 without channel coding)

DPDCH / DTCH

(UE1 with channel coding)

Selects the data source for the E-DPDCH channel.

When the selection is UE2 ... UE4, the data source for the DPDCH is always entered here.

The data source for the DPDCH is also entered here for the enhanced channels of UE1 without channel coding.

When channel coding is active, the data source for the DTCH1 component in the transport layer is selected here. In this situation, the display reads **DPDCH / DTCH** and the **DCCH Data** entry field is enabled for selecting the data source of the DCCH channel. The data sources of the other DTCH channels can be set in the **Global Enhanced Channel Settings in the Transport Channel section** submenu, see Section "[Global Enhanced Channel Settings - UE1 - 3GPP FDD](#)", Page 4.470.

The following are available for selection as data sources:

**All 0** 0 data and 1 data is generated internally.

**All 1** Remote-control commands:  

```
SOUR:BB:W3GP:MST1:HSUP:CHAN1:DPDC:E:DA
TA ZERO | ONE
```

**PN xx** PRBS data as per CCITT with period lengths between  $2^9-1$  and  $2^{23}-1$  is generated internally.

Remote-control commands:  

```
SOUR:BB:W3GP:MST1:HSUP:CHAN1:DPDC:E:DA
TA PN9 | PN11 | PN15 | PN16 | PN20 |
PN21 | PN23
```

**Pattern**  
**Pattern**

A user-definable bit pattern with a maximum length of 64 bits is generated internally.

The bit pattern is defined in the **Pattern** entry field.



Remote-control commands:

```
SOUR:BB:W3GP:MST1:HSUP:CHAN1:DPDC:E:DATA PATT
SOUR:BB:W3GP:MST1:HSUP:CHAN1:DPDC:E:PATT #H3F,8
```

**Data List**

Internal data from a programmable data list generated with the Data Editor or externally, is used.

Data lists are selected in the **File Select** window, which is called by means of the **Select Data List** button.



The **File Manager** is used to transmit external data lists to the R&S Vector Signal Generator, and can be called within every **File Select** window by means of the **File Manager** button.

Remote-control commands:

```
SOUR:BB:W3GP:MST1:CHAN1:DPDC:E:DATA DLIS
SOUR:BB:W3GP:MST1:CHAN1:DPDC:E:DSEL "dp1"
```

## HSUPA FRC Settings - UE - 3GPP FDD

**State – HSUPA FRC - 3GPP FDD**

Activates or deactivates the FRC state for the E-DPCCH channels.

Remote-control command:

```
SOUR:BB:W3GP:MST1:HSUP:DPCC:E:FRC:STAT ON
```

**Fixed Reference Channel (FRC) – HSUPA FRC - 3GPP FDD**

Selects the FRC according to TS 25.141 Annex A.10.

The value range is 1 to 7.

Remote-control command:

```
SOUR:BB:W3GP:MST1:HSUP:DPCC:E:FRC:CHAN 4
```

**Maximum Information Bitrate/kbps – HSUPA FRC - 3GPP FDD**

Displays the maximum information bit rate.

Remote-control command:

```
SOUR:BB:W3GP:MST1:HSUP:DPCC:E:FRC:MIBR?
Response: 1353.0
```

<b>E-DCH TTI – HSUPA FRC - 3GPP FDD</b>	<p>Displays the TTI (Transmission Time Interval).</p> <p>Remote-control command:  SOUR:BB:W3GP:MST1:HSUP:DPCC:E:FRC:TTIE?  Response: 2ms</p>
<b>Number Of HARQ Processes – HSUPA FRC - 3GPP FDD</b>	<p>Displays the number of HARQ (Hybrid-ARQ Acknowledgement) process. This value determines the distribution of the payload in the subframes.</p> <p>Remote-control command:  SOUR:BB:W3GP:MST1:HSUP:DPCC:E:FRC:HPRO?  Response: 5</p>
<b>Information Bit Payload (Ninf) – HSUPA FRC - 3GPP FDD</b>	<p>Displays the payload of the information bit. This value determines the number of transport layer bits sent in each HARQ process.</p> <p>Remote-control command:  SOUR:BB:W3GP:MST1:HSUP:DPCC:E:FRC:PAYB?  Response: 2706</p>
<b>Binary Channel Bits/TTI (Nbin) – HSUPA FRC - 3GPP FDD</b>	<p>Displays the number of physical bits sent in each HARQ process.</p> <p>Remote-control command:  SOUR:BB:W3GP:MST1:HSUP:DPCC:E:FRC:TTIB?  Response: 3840</p>
<b>Coding Rate (Nint/Nbin) – HSUPA FRC - 3GPP FDD</b>	<p>Displays the relation between the information bits to binary channel bits.</p> <p>Remote-control command:  SOUR1:BB:W3GP:MST1:HSUP:DPCC:E:FRC:CRAT?  Response: 0.705</p>
<b>(SF For Each) Physical Channel Codes – HSUPA FRC - 3GPP FDD</b>	<p>Displays the number of the E-DPDCHs with the corresponding channelization codes.</p> <p>Remote-control command:  SOUR:BB:W3GP:MST1:HSUP:DPCC:E:FRC:PCCO?  Response: 4.4</p>
<b>State (DTX) – HSUPA FRC - 3GPP FDD</b>	<p>Activates or deactivates the DTX (Discontinuous Transmission) mode.</p> <hr/> <p><b>Note:</b>  <i>If activated, this setting is also set in the E-DPDCH Settings and E-DPCCH Settings menu. The settings in the menus will be overwritten.</i></p> <hr/> <p>Remote-control command:  SOUR:BB:W3GP:MST1:HSUP:DPCC:E:FRC:DTX:STAT ON</p>

**User Data (DTX Pattern) –  
HSUPA FRC - 3GPP FDD**

Sets user-definable the bit pattern for the DTX. The maximum length is 64 bits.

The following values are allowed:

1: Data transmission

-: DTX

**Note:**

*This setting will overwrite the DTX pattern settings in the E-DPCCH Settings and E-DPDCH Settings menu.*

Remote-control command:

SOUR:BB:W3GP:MST1:HSUP:DPCC:E:FRC:DTX:PATT "11-1-"

**State (Virtual HARQ Mode) –  
HSUPA FRC - 3GPP FDD**

Activates or deactivates the virtual HARQ mode. If activated, a feedback from the base station is simulated.

Remote-control command:

SOUR:BB:W3GP:MST1:HSUP:DPCC:E:FRC:HARQ:STAT ON

**HARQ: ACK/NACK –  
HSUPA FRC - 3GPP FDD**

Enters the pattern for the HARQ-ACK field (Hybrid-ARQ Acknowledgement).

Remote-control command:

SOUR:BB:W3GP:MST1:HSUP:DPCC:E:FRC:HARQ:PATT4 "1010"

**"1" = ACK**

The HARQ ACK is sent. Transmission was successful and correct.

**"0" = NACK**

The NACK is not sent. Transmission was not correct. With an NACK, the UE requests retransmission of the incorrect data.

**"-" = DTX**

Nothing is sent. Transmission is interrupted (Discontinuous Transmission).

**Bit Error State - HSUPA  
FRC - 3GPP FDD**

Activates or deactivates bit error generation.

Bit errors are inserted into the data fields of the enhanced channels. When channel coding is active, it is possible to select the layer in which the errors are inserted (physical or transport layer).

When the data source is read out, individual bits are deliberately inverted at random points in the data bit stream at the specified error rate in order to simulate an invalid signal.

Remote-control command:

SOUR:BB:W3GP:MST1:HSUP:DPCC:E:FRC:DERR:BIT:STAT ON



<b>Bit Error Rate - HSUPA FRC - 3GPP FDD</b>	<p>Sets the bit error rate. The value range is 10E-1 to 10E-7.</p> <p>Remote-control command: SOUR:BB:W3GP:MST1:HSUP:DPCC:E:FRC:DERR:BIT:RATE 1e-3</p>
<b>Insert Errors On - HSUPA FRC - 3GPP FDD</b>	<p>Selects the layer in the coding process at which bit errors are inserted.</p> <p><b>Transport layer</b> Bit errors are inserted in the transport layer. This selection is only available when channel coding is active. Remote-control command: SOUR:BB:W3GP:MST1:HSUP:DPCC:E:FRC:DER R:BIT:LAY TRAN</p> <p><b>Physical layer</b> Bit errors are inserted in the physical layer. Remote-control commands: SOUR:BB:W3GP:MST1:HSUP:DPCC:E:FRC:DER R:BIT:LAY PHYS</p>
<b>Block Error State - HSUPA FRC - 3GPP FDD</b>	<p>Activates or deactivates block error generation.</p> <p>The CRC checksum is determined and then the last bit is inverted at the specified error probability in order to simulate an invalid signal.</p> <p>Remote-control command: SOUR:BB:W3GP:MST1:HSUP:DPCC:E:FRC:DERR:BLOC:STAT ON</p>
<b>Block Error Rate - HSUPA FRC - 3GPP FDD</b>	<p>Sets block error rate.</p> <p>Remote-control command: SOUR:BB:W3GP:MST1:HSUP:DPCC:E:FRC:DERR:BLOC:RATE 1E-3</p>

## Global Enhanced Channel Settings - UE1 - 3GPP FDD

The **Global Enhanced Settings** menu can also be called in the UE1 **User Equipment Configuration** menu by using the **Global Enhanced Settings** button.

**Only available for user equipment 1 (UE1). The settings always apply to all the active DPDCH channels.**

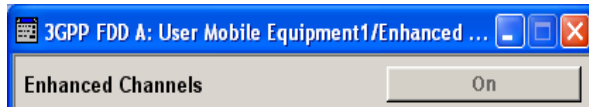

The upper section is where the enhanced state of all the UE1 channels is displayed.

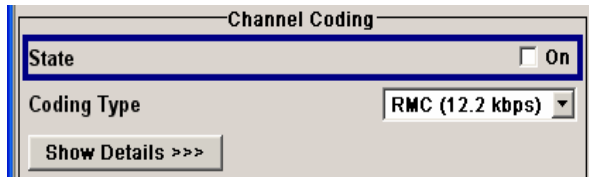

The **Channel Coding** section is where the channel coding settings are made. You can choose between a reduced display, where it is only possible to select the coding scheme, and a display with detailed setting options. The **Transport Channel** section for detailed settings can be revealed with the **Show Details >>>** button and hidden with the **<<< Hide Details** button.

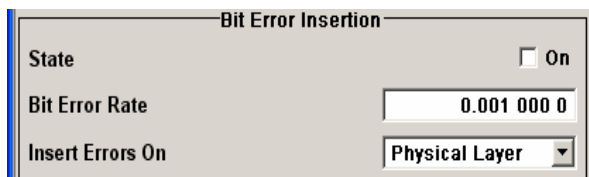

The **Bit Error Insertion** section is where the bit error simulation is configured and activated.

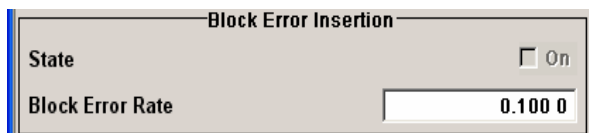

The **Block Error Insertion** section is where the block error simulation is configured and activated.

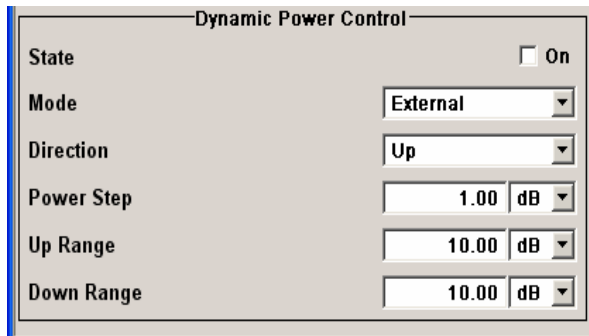

In the **Dynamic Power Control** section, the power of the Enhanced Channels can be increased or decreased within the predefined dynamic range (**Up Range + Down Range**) and with the predefined step size (**Power Step**).

### Enhanced DPDCH Channels State - UE 1 - 3GPP FDD

Displays the enhanced state of the DCDCH channels.

The channels of user equipment 1 are always generated in the enhanced state, i.e. in realtime. It is possible to activate channel coding and simulate bit and block errors. Data lists, for example with user data for the transport layer, can be used as the data source.

Remote-control command: `n.a.`

# Channel Coding - DPDCH Enhanced UE 1 - 3GPP FDD

The **Channel Coding** section is where the channel coding settings are made. You can choose between a reduced display and the detailed setting options display. With the reduced display, it is only possible to select the coding scheme and this selection sets the associated parameters to the presetting prescribed in the standard. The **Transport Channel** section for detailed setting and for defining a user coding can be revealed with the **Show Details >>>** button and hidden with the **<<< Hide Details** button.

An uplink reference measurement channel according to 3GPP TS 25.141 is generated when the transport channels DTCH (Dedicated Traffic Channel) and DCCH (Dedicated Control Channel), which contain the user data, are mapped to a DPDCH (Dedicated Physical Data Channel) with a different data rate after channel coding and multiplexing. The display below is taken from the standard (TS 25.141) and shows in diagrammatic form the generation of a 12.2 kbps reference measurement channel from the DTCH and DCCH transport channels.

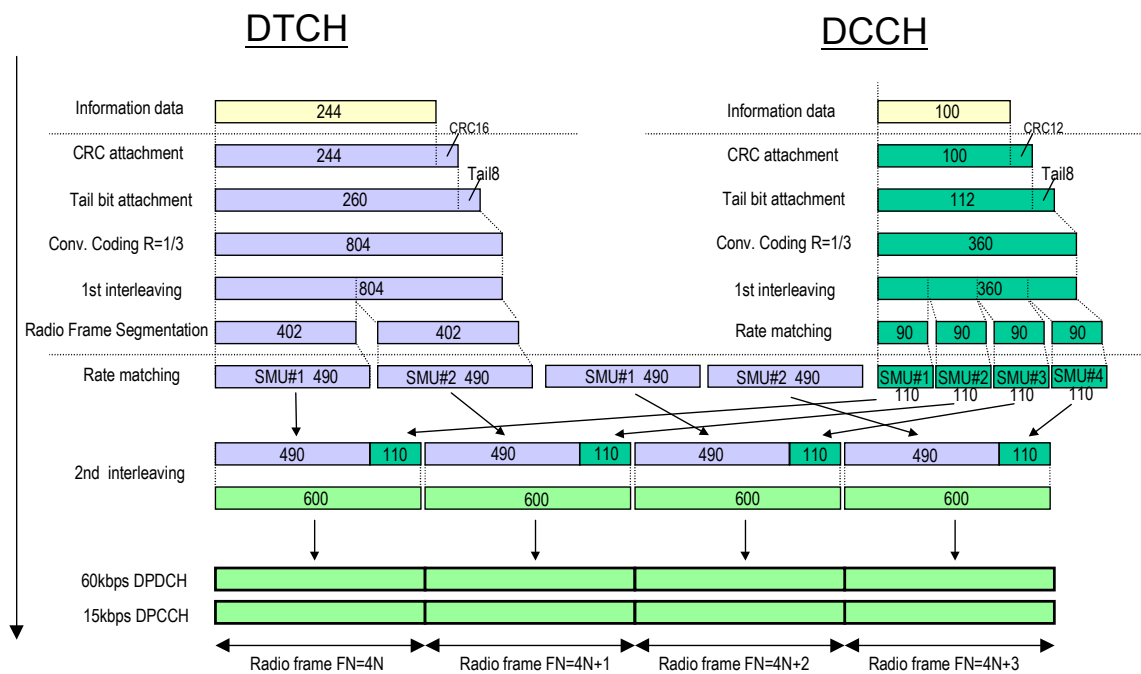

Fig. 4-41 Channel coding of the 12.2 kbps reference measurement channels (uplink)

**Channel Coding State - Enhanced DPDCH UE1 - 3GPP FDD**

Activates or deactivates channel coding.

**Note:**

*Annex A.1, 3GPP TS 25.141, lists the recommended DPCCH-settings.*

**Remote-control command:**

SOUR:BB:W3GP:MST:ENH:DPDC:CCOD:STAT ON

**Coding Type - Enhanced  
DPDCH UE1 - 3GPP FDD**

Selects channel coding.

The 3GPP specification defines 4 reference measurement channel coding types, which differ in the input data bit rate bit to be processed (12.2, 64, 144 and 384 ksps). The additional AMR CODER coding scheme generates the coding of a voice channel.

**User** codings can be defined as required in the detailed coding settings menu section revealed with button **Show Details >>>**. They can be stored and loaded in the **User Coding...** submenu. Selection **User** is indicated as soon as a coding parameter is modified after selecting a predefined coding type.

The input data bits are taken from the data source specified for the **Transport Channels** for channel coding. The bits are available with a higher rate at the channel coding output. The allocations between the measurement input data bit rate and the output symbol rate are fixed, that is to say, the overall symbol rate is adjusted automatically.

The following are available for selection:

**RMC 12.2 kbps:** 12.2 kbps measurement channel

**RMC 64 kbps:** 64 kbps measurement channel

**RMC 144 kbps:** 144 kbps measurement channel

**RMC 384 kbps:** 384 kbps measurement channel

**AMR 12.2 kbps:** Channel coding for the AMR coder

Remote-control command:

```
SOUR:BB:W3GP:MST:ENH:DPDC:CCOD:TYPE M12K |M64K
|M144K |M384K | AMR
```

**Show Details - Enhanced  
DPDCH UE1 - 3GPP FDD**

Reveals the detailed setting options for channel coding.

Available as well as the **Transport Channel** section are the **Overall Symbol Rate** and **Bits per Frame** parameters as well as the **User Coding** button.

Once the details are revealed, the labelling on the button changes to **<<< Hide Details**. Use this to hide the detailed setting options display again.

Remote-control command: n.a.

**User Coding ... - DPDCH  
Enhanced UE - 3GPP FDD**

Calls the **User Coding** menu.

From the **User Coding** menu the **File Select** windows for saving and recalling user-defined channel codings and the **File Manager** can be called.



User coding of UE1 are stored as files with the predefined file extension **\*.3g\_ccod\_ul**. The file name and the directory they are stored in are user-definable, the file extension is assigned automatically.

The complete channel coding settings in the menu section **Show Details>>>** are saved and recalled.

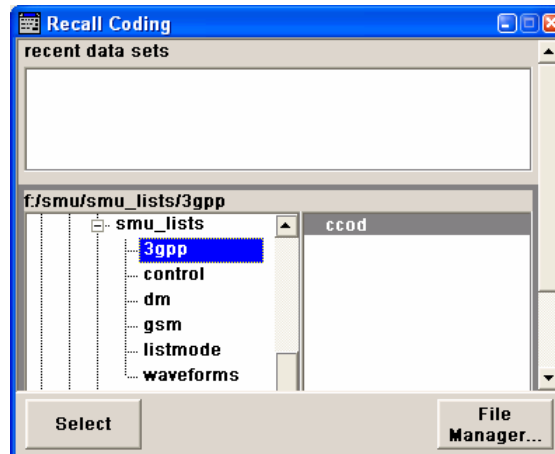

Remote-control command:

```
MMEM:CDIR "f:/gen_lists/3gpp"
SOUR:BB:W3GP:MST:ENH:CCOD:DPDC:USER CAT?
SOUR:BB:W3GP:MST:ENH:DPDC:CCOD:USER:DEL "c_ue1"
SOUR:BB:W3GP:MST:ENH:CCOD:DPDC:USER:LOAD "cod_ue1"
SOUR:BB:W3GP:MST:ENH:CCOD:DPDC:USER:STOR "cod_ue1"
```

**Overall Symbol Rate - Enhanced DPDCH UE1 - 3GPP FDD**

Sets the overall symbol rate of all the DPDCHs.

The structure of the DPDCH channel table depends on this parameter. The overall symbol rate determines which DPDCHs are active, which symbol rate they have and which channelization codes they use (see [Table 4-22 Structure of the DPDCH channel table in conjunction with the overall symbol rate](#)).

DPDCHs that are not active by virtue of the overall rate, are also disabled for operation.

**Note:**

*Up to an overall rate of 960 ksps, only DPDCH 1 is active, its symbol rate is the same as the overall rate and the channelization code is the same as spreading factor/4 (spreading factor = chip rate / symbol rate). With an overall symbol rate greater than 960 ksps, all the active DPDCHs have the symbol rate 960 ksps.*

Remote-control command:

SOUR:BB:W3GP:MST:ENH:DPDC:ORAT?

**Bits per Frame (DPDCH) - Enhanced DPDCH UE1 - 3GPP FDD**

Displays the data bits in the DPDCH component of the frame at physical level. The value depends on the overall symbol rate.

Remote-control command:

SOUR:BB:W3GP:MST:ENH:DPDC:BPFR?

## Transport Channel - Enhanced DPDCH UE1 - 3GPP FDD

In the **Transport Channel** section, up to 7 transport channels (TCHs) can be configured. The first one is always a DCCH, the other six are DTCHs (DTCH1 to 6). The most important parameters of the TCH are displayed (data source and transport block size). The associated parameters shown in the section below depend on which TCH is currently selected.

A wide arrow beneath the block indicates which TCH is currently selected.

Transport Channel						
DTCH 1	DTCH 2	DTCH 3	DTCH 4	DTCH 5	DTCH 6	DCCH
244	100	100	100	100	100	100
PN 9	PN 9	PN 9	PN 9	PN 9	PN 9	PN 9
<input checked="" type="checkbox"/> On	<input type="checkbox"/> On	<input type="checkbox"/> On	<input type="checkbox"/> On	<input type="checkbox"/> On	<input type="checkbox"/> On	<input checked="" type="checkbox"/> On
Data Source				PN 9		
Transport Time Intervall				20 ms		
Transport Blocks				1		
Transport Block Size				244		
Size Of CRC				16		
Rate Matching Attribute				1		
Error Protection				Conv 1/3		
Interleaver 1 State				<input checked="" type="checkbox"/> On		
Interleaver 2 State				<input checked="" type="checkbox"/> On		

**Transport Channel State -  
Enhanced DPDCH UE1 -  
3GPP FDD**

Activates or deactivates the transport channel.

Remote-control command:

SOUR:BB:W3GP:MST:ENH:DPDC:TCH1:STAT ON

**Note:**

*In case of remote control, DCCH corresponds to :TCHannel0,  
DTCH1 to :TCHannel1, etc.*

**Data Source TCH -  
Enhanced DPDCH UE1 -  
3GPP FDD**

Selects the data source for the transport channel.

The data source for the DCCH and DTCH1 can also be selected in the main menu in the channel table.

The following are available for selection as data sources:

**All 0**

0 data and 1 data is generated internally.

**All 1**

Remote-control command:

SOUR:BB:W3GP:MST:ENH:DPDC:TCH1:DATA  
ZERO | ONE

**PN xx**

PRBS data as per CCITT with period lengths between  $2^9-1$  and  $2^{23}-1$  is generated internally.

Remote-control commands:

SOUR:BB:W3GP:MST:ENH:DPDC:TCH1:DATA  
PN9 | PN15 | PN16 | PN20 | PN21 | PN23

**Pattern  
Pattern**

A user-definable bit pattern with a maximum length of 64 bits is generated internally.

The bit pattern is defined in the **Data Pattern** entry field.

Remote-control commands:

SOUR:BB:W3GP:MST:ENH:DPDC:TCH1:DATA  
PATT  
SOUR:BB:W3GP:MST:ENH:DPDC:TCH1:DATA:P  
ATT #H3F,8

**Data List  
Select  
Data List**

Internal data from a programmable data list generated with the Data Editor or externally, is used.

Data lists are selected in the **Select Data List** field.

Remote-control command:

SOUR:BB:W3GP:MST:ENH:DPDC:TCH1:DATA  
DLIS  
SOUR:BB:W3GP:MST:ENH:DPDC:TCH1:DSEL  
"dpdc\_1"

<b>Transport Time Interval TCH - Enhanced DPDCH UE1 - 3GPP FDD</b>	<p>Sets the number of frames into which a TCH is divided. This setting also defines the interleaver depth.</p> <p>Remote-control command: SOUR:BB:W3GP:MST:ENH:DPDC:TCH1:TTIN 10 ms</p>
<b>Number of Transport Blocks TCH - Enhanced DPDCH UE1 - 3GPP FDD</b>	<p>Sets the number of transport blocks for the TCH.</p> <p>Remote-control command: SOUR:BB:W3GP:MST:ENH:DPDC:TCH1:TBC 2</p>
<b>Transport Block Size TCH - Enhanced DPDCH UE1 - 3GPP FDD</b>	<p>Sets the size of the transport block at the channel coding input.</p> <p>Remote-control command: SOUR:BB:W3GP:MST:ENH:DPDC:TCH1:TBS 244</p>
<b>Size of CRC TCH - Enhanced DPDCH UE1 - 3GPP FDD</b>	<p>Defines the type (length) of the CRC. Checksum determination can also be deactivated (setting <b>None</b>).</p> <p>Remote-control command: SOUR:BB:W3GP:MST:ENH:DPDC:TCH1:CRCS 8</p>
<b>Rate Matching Attribute TCH - Enhanced DPDCH UE1 - 3GPP FDD</b>	<p>Sets data rate matching (Rate Matching).</p> <p>Remote-control command: SOUR:BB:W3GP:MST:ENH:DPDC:TCH1:RMAT 256</p>
<b>Error Protection TCH- Enhanced DPDCH UE1 - 3GPP FDD</b>	<p>Selects error protection.</p>
	<p><b>None</b>                      No error protection</p> <p>Remote-control command: SOUR:BB:W3GP:MST:ENH:DPDC:TCH1:EPR NONE</p>
	<p><b>Turbo 1/3</b>                      Turbo Coder of rate 1/3 in accordance with the 3GPP specifications.</p> <p>Remote-control commands: SOUR:BB:W3GP:MST:ENH:DPDC:TCH1:EPR TURB3</p>
	<p><b>Conv 1/2   1/3</b>                      Convolution Coder of rate 1/2 or 1/3 with generator polynomials defined by 3GPP.</p> <p>Remote-control command: SOUR:BB:W3GP:MST:ENH:DPDC:TCH1:EPR CON2</p>



**Interleaver 1 State TCH - Enhanced DPDCH UE1 - 3GPP FDD**

Activates or deactivates channel coding interleaver state 1 of the transport channel. Interleaver state 1 can be set independently in each TCH. Activation does not change the symbol rate.

Remote-control command:

SOUR:BB:W3GP:MST:ENH:DPDC:TCH1:INT1 ON

**Interleaver 2 State TCH - Enhanced DPDCH UE1 - 3GPP FDD**

Activates or deactivates channel coding interleaver state 2 of all the transport channels. Interleaver state 2 can only be set for all the TCHs together. Activation does not change the symbol rate.

Remote-control command:

SOUR:BB:W3GP:MST:ENH:DPDC:INT2 ON

## Error Insertion - Enhanced DPDCH UE1 - 3GPP FDD

In the **Bit Error Insertion** and **Block Error Insertion** sections, errors can be inserted into the data source and into the CRC checksum, in order, for example, to check the bit and block error rate testers.

Bit Error Insertion	
State	<input type="checkbox"/> On
Bit Error Rate	<input type="text" value="0.001 0"/>
Insert Errors On	<input type="text" value="Physical Layer"/>
Block Error Insertion	
State	<input type="checkbox"/> On
Block Error Rate	<input type="text" value="0.100 0"/>

**Bit Error State - Enhanced DPDCH UE1 - 3GPP FDD**

Activates or deactivates bit error generation.

Bit errors are inserted into the data fields of the enhanced channels. When channel coding is active, it is possible to select the layer in which the errors are inserted (physical or transport layer).

When the data source is read out, individual bits are deliberately inverted at random points in the data bit stream at the specified error rate in order to simulate an invalid signal.

Remote-control command:

SOUR:BB:W3GP:MST:ENH:DPDC:DERR:BIT:STAT ON

**Bit Error Rate TCH - Enhanced DPDCH UE1 - 3GPP FDD**

Sets the bit error rate.

Remote-control command:

SOUR:BB:W3GP:MST:ENH:DPDC:DERR:BIT:RATE 1E-3

**Insert Errors On -  
Enhanced DPDCH UE1 -  
3GPP FDD**

Selects the layer at which bit errors are inserted.

**Transport layer**

Bit errors are inserted in the transport layer.

This layer is only available when channel coding is active.

Remote-control command:

```
SOUR:BB:W3GP:MST:ENH:DPDC:DERR:BIT:LA  
Y TRAN
```

**Physical layer**

Bit errors are inserted in the physical layer.

Remote-control commands:

```
SOUR:BB:W3GP:MST1:ENH:DPDC:DERR:BIT:L  
AY PHYS
```

**Block Error State -  
Enhanced DPDCH UE1 -  
3GPP FDD**

Activates or deactivates block error generation.

The CRC checksum is determined and then the last bit is inverted at the specified error probability in order to simulate an invalid signal.

Block error generation is only available when channel coding is active.

Remote-control command:

```
SOUR:BB:W3GP:MST:ENH:DPDC:DERR:BLOC:STAT ON
```

**Block Error Rate -  
Enhanced DPDCH UE1 -  
3GPP FDD**

Sets the block error rate.

Remote-control command:

```
SOUR:BB:W3GP:MST:ENH:DPDC:DERR:BLOC:RATE 1E-3
```

## Dynamic Power Control - DPDCH Enhanced User Equipment - 3GPP FDD

In the **Dynamic Power Control** section of menu **Enhanced Settings**, the power of the enhanced channels can be increased or decreased within the predefined dynamic range (**Up Range** + **Down Range**) and with the predefined step size (**Power Step**) with an external, internal or manual control signal.

Dynamic Power Control	
State	<input type="checkbox"/> On
Mode	External
Direction	Up
Power Step	1.00 dB
Up Range	10.00 dB
Down Range	10.00 dB

**Dynamic Power Control State - Enhanced DPDCH UE1 - 3GPP FDD**

Activates or deactivates the **Dynamic Power Control**.

Remote-control command:

```
SOUR:BB:W3GP:MST:ENH:DPDC:DPC:STAT ON
```

**Mode - Enhanced DPDCH UE1 - 3GPP FDD**

Selects the control signal for **Dynamic Power Control**.

**External**

An external control signal is used for Dynamic Power Control. The external control signal is supplied via the LEV ATT input of the AUX I/O connector (path A) or via one of the USER interfaces (path B).

**Note:**

*Marker 4 must be set to **Slot** mode if Dynamic Power Control with external control signal is active.*

Remote-control command:

```
SOUR:BB:W3GP:MST:ENH:DPDC:DPC:MODE EXT
```

**By TPC Pattern**

The TPC pattern is used for Dynamic Power Control. This selection corresponds to selection (Mis)Use TPC for not enhanced channels.

Remote-control command:

```
SOUR:BB:W3GP:MST:ENH:DPDC:DPC:MODE TPC
```

**Manual**

The control signal is manually produced by pushing one of the buttons **0** or **1**.

The channel power is increased or decreased depending on the **Direction** setting by the set power step.

Remote-control command:

```
SOUR:BB:W3GP:MST:ENH:DPDC:DPC:MODE MAN
```

```
SOUR:BB:W3GP:MST:ENH:DPDC:DPC:STEP:MAN
```

```
MAN1
```

**Direction - Enhanced DPCHs BS1 - 3GPP FDD**

Selects the **Dynamic Power Control** mode.

**Up**

A high level of the control signal leads to an increase of channel power.

Remote-control command:

```
SOUR:BB:W3GP:MST:ENH:DPDC:DPC:DIR UP
```

**Down**

A high level of the control signal leads to a decrease of channel power.

Remote-control command:

```
SOUR:BB:W3GP:MST:ENH:DPDC:DPC:DIR
```

```
DOWN
```

**Power Step - DPDCH  
Enhanced UE - 3GPP FDD**

Sets step width by which – with the **Dynamic Power Control** being switched on - the channel powers of the enhanced channels in the timeslot grid are increased or decreased within the set dynamic range (**Up Range + Down Range**).

The start power of the channel is set in the **Channel Power** entry field of the menu.

Remote-control command:

```
SOUR:BB:W3GP:MST:ENH:DPDC:DPC:STEP 1
```

**Up Range - DPDCH  
Enhanced UE - 3GPP FDD**

Sets dynamic range by which – with **Dynamic Power Control** switched on – the channel powers of the enhanced channels can be increased. The resulting **Dynamic Power Control** dynamic range (**Up Range + Down Range**) may be 30 dB at max.

Remote-control command:

```
SOUR:BB:W3GP:MST:ENH:DPDC:DPC:RANG:UP 10.0
```

**Down Range - DPDCH  
Enhanced UE - 3GPP FDD**

Sets dynamic range by which – with **Dynamic Power Control** switched on – the channel powers of the enhanced channels can be decreased. The resulting **Dynamic Power Control** dynamic range (**Up Range + Down Range**) may be 30 dB at max.

Remote-control command:

```
SOUR:BB:W3GP:MST:ENH:DPDC:DPC:RANG:DOWN 10.0
```

**Power Control Graph -  
DPDCH Enhanced UE -  
3GPP FDD**

Indicates the deviation of the channel power ( $\Delta$ POW) from the set power start value of the enhanced channels.

The graph is automatically displayed with **Dynamic Power Control** switched on.

**Note:**

*Since a realtime update of the window in the timeslot (= 0.667 ms) is not possible for reasons of speed, an update can be performed in a more coarse time interval. Fast channel power changes are not displayed but the settled state of the control loop can be recognized very easily.*

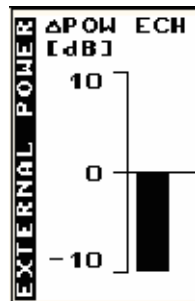

Remote-control command:

```
SOUR:BB:W3GP:MST:ENH:DPDC:DPC:POW?
```

# Tests on Base Stations in Conformance with the 3G Standard 3GPP-FDD

## Introduction - Test Case Wizard

The Test Case Wizard supports tests on base stations in conformance with the 3G Standard 3GPP-FDD. It offers a selection of predefined settings according to Test Cases in TS 25.141.

The basic equipment layout for the test is the same as for the 3GPP FDD signal generation. It includes the options Baseband Main Module (B13), Baseband Generator (B10/B11) and Digital Standard 3GPP FDD (K42). However, some of the tests require further options.

The Test Case Wizard has effect on frequency and level settings, link direction, trigger, baseband clock source, marker settings and base station or user equipment configuration. Besides the 3GPP required settings also interfering signals (AWGN, CW interferer, co-located modulation signals) are set.

The degree of freedom in setting the parameters can be determined. The "**According to Standard**" edit mode allows only settings in compliance with TS 25.141. The "**User Definable**" edit mode allows a wider range of settings.

The menu for selecting the 3GPP FDD test is either called in 3GPP FDD menu from the baseband block or from the menu tree under Baseband 3GPP FDD.

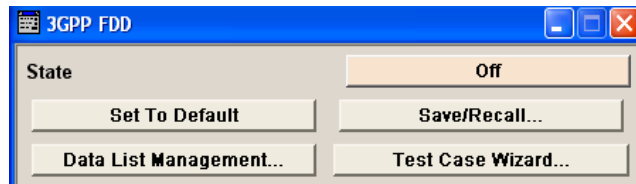

Button **Test Case Wizard** opens the menu.

Test Case: 8.3.1. Demodulation of DCH in Multipath Fading Case 1 Conditions...

**General Settings**

Edit Mode: According to Standard  
 Trigger Configuration: Auto (Ext. Trigger 1)  
 Marker Configuration: Auto  
 Diversity: Off  
 Baseband A Signal Routing: To Path and RF Port A

**Basestation Configuration**

Scrambling Code (hex): 0  
 Scrambling Mode: Long Scrambling Code  
 Power Class: Wide Area BS

**Wanted Signal**

State: On  
 Reference Measurement Channel: RMC 12.2 kbps  
 RF Frequency: 1.000 000 000 GHz  
 Power Level: -89.28 dBm

**AWGN Configuration**

State: On  
 Required BLER: < 0.01  
 Power Level (within 3.84 MHz BW): -84.00 dBm  
 Eb/NO: 19.7 dB

**Fading Configuration**

State: On

Apply Settings

The Test Wizard menu is divided into several sections:

At the top of the panel, the test case is selected. In the **General Settings** section the edit mode and the general signal generator parameters are set.

The base station parameters are input in the **Basestation Configuration** section.

The graph in the right upper section symbolizes the interference scenario defined by power level and frequency offset.

The middle section depends on the selected test case. It displays the input/output parameters of the wanted and the interfering signals and further configuration entries besides the default settings.

Button **Apply Settings** activates the preset settings for the selected test case. Further modification of the generator settings is still possible. Signal generation starts with the first trigger event.

With the **Test Case Wizard**, it is possible to create highly complex test scenarios with just a few keystrokes, see the following example:

1. Preset the signal generator
2. Call the **Test Case Wizard** menu in the 3GPP menu
3. Choose the desired test case
4. Enter the specific settings for the selected test case , e.g. frequency, level, ...
5. Activate the settings using the **Apply Settings** button
6. Switch on RF output and further refine the generator settings if required
7. Start signal generation by a trigger from the base station at connector TRIGGER1.

## General Considerations - Test Case Wizard - 3GPP FDD

### Test Frequencies

For 3GPP-FDD, several paired frequency bands are used. The following table shows start and stop frequencies of both uplink (UE transmit, node B receive) and downlink (node B transmit, UE receive) frequency bands according to 3GPP.

Operating band	Uplink frequencies UE transmit, node B receive	Downlink frequencies UE receive, node B transmit
I	1920 MHz to 1980 MHz	2110 MHz to 2170 MHz
II	1850 MHz to 1910 MHz	1930 MHz to 1990 MHz
III	1710 MHz to 1785 MHz	1805 MHz to 1880 MHz
IV	1710 MHz to 1755 MHz	2110 MHz to 2155 MHz
V	824 MHz to 849MHz	869 MHz to 894MHz
VI	830 MHz to 840 MHz	875 MHz to 885 MHz

The measurements that have to be performed according to 3GPP in order to verify proper operation of FDD systems apply to appropriate frequencies in the bottom, middle and top of the operating frequency band of the base station (BS). These frequencies are denoted as RF channels B (bottom), M (middle) and T (top).

### Reference Frequency:

When building up the measurement setups according to TS 25.141 it might be useful that all the instruments share a common reference clock. However, after **Preset** the signal generator uses its internal clock reference. In order to feed in the clock of an external clock the RF module configuration should be switched to external reference frequency.

External Reference Frequency	
Source	External
External Reference Frequency	10 MHz
Synchronisation Bandwidth	Standard

In the external reference mode an external signal with selectable frequency and defined level must be input at the **REF IN** connector. This signal is output at the **REF OUT** connector. The reference frequency setting is effective for both paths. For very good reference sources of high spectral purity a wideband setting is provided.

**Trigger Signal:**

For test cases with channel coded signal, e.g. an activated RMC, the base station that triggers the signal generation must emit an 'SFN (System Frame Number) mod 4' periodic trigger. A simple SFN periodic trigger probably will disturb the channel coding scheme.

**Baseband Clock:**

The clock source is automatically switched to internal when the test case settings are activated.

**Improvement of signal quality:**

Improvement of signal quality is possible via several settings:

- In the **I/Q Settings** menu the internal baseband gain can be set to improved ACLR performance (3 dB or 6 dB)

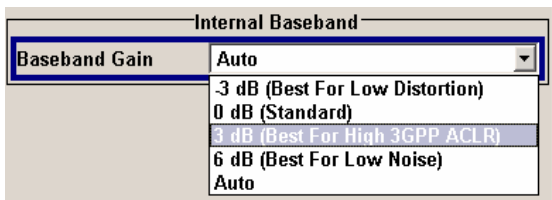

- In the **Automatic Level Control Settings** menu the RF output level can be recalibrated with **Search Once** in **Sample&Hold** mode. This is recommended if in CW mode the signal/intermodulation ratio is to be improved for multi-transmitter measurements. With setting **Auto**, the level control is automatically adapted to the operating conditions, it may cause increased intermodulations, however.

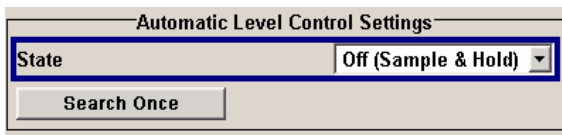

- In the **User Correction** menu a list of correction values can be created and subsequently activated. Thus, the frequency response of the test setup can be taken into account .

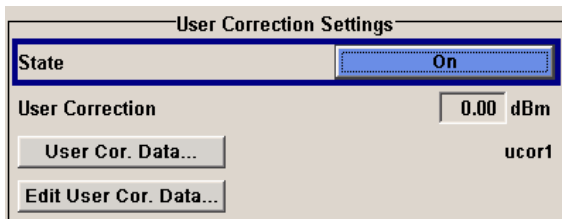

- In order to compensate cable loss and additionally inserted attenuators, the RF level can directly be adjusted in the **Level** input field.



- Additional settings in the impairments section of the AWGN block





## General Settings - Test Case Wizard - 3GPP FDD

### Test Case- Test Case Wizard - 3GPP FDD

Selects the test case. The following table gives an overview of the available test cases, the type of signal transmitted by the signal generator and the required additional options besides the basic configuration. An equipment layout as required for 3GPP FDD signal generation for one-path instruments is assumed to be the basic configuration.

Remote-control command:

SOUR:BB:W3GP:TS25141:TCAS TC881

### Transmitter Tests

TS 25.141 chapter	Test case	Generator Signal	Additional options
6.4.2	Power control steps: Output power dynamics	Uplink	-
6.6	Transmit intermodulation	Interferer (downlink)	-

### Receiver Tests

TS 24.141 chapter	Test case	Generator Signal	Additional signal generator options
7.2	Reference sensitivity level	Uplink	-
7.3	Dynamic range	Uplink, AWGN	K62, AWGN
7.4	Adjacent Channel Selectivity (ACS)	Uplink, Interferer	B20x, RF path B 2nd B13, Baseband Main Module 2nd B10, Baseband Generator, 2nd K42, 3GPP FDD
7.5	Blocking characteristics	Uplink, Interferer	B20x, RF path B 2nd B13, Baseband Main Module 2nd B10, Baseband Generator, 2nd K42, 3GPP FDD
7.6	Intermodulation characteristics	Uplink, 2 x Interferer	B20x, RF path B 2nd B13, Baseband Main Module 2nd B10, Baseband Generator, 2nd K42, 3GPP FDD K62, AWGN
7.8	Verification of the internal BER calculation	Uplink	-
8.2.1	Performance requirement - Demodulation in static propagation conditions: Demodulation of DCH	Uplink, AWGN	B20x, RF path B 2nd B13, Baseband Main Module 2x K62, AWGN
8.6	Verification of the internal BLER calculation	Uplink	B20x, RF path B 2nd B13, Baseband Main Module
8.8.1	RACH performance: RACH preamble detection in static propagation conditions	Uplink, AWGN	B20x, RF path B 2nd B13, Baseband Main Module 2x K62, AWGN
8.8.3	RACH performance: Demodulation of RACH message in static propagation conditions	Uplink, AWGN	B20x, RF path B 2nd B13, Baseband Main Module 2x K62, AWGN

TS 24.141 chapter	Test case	Generator Signal	Additional signal generator options
8.9.1	CPCH performance: CPCH access preamble and collision detection, preamble detection in static propagation conditions	Uplink, AWGN	B20x, RF path B 2nd B13, Baseband Main Module 2x K62, AWGN
8.9.3	CPCH performance: Demodulation of CPCH message in static propagation conditions	Uplink, AWGN	B20x, RF path B 2nd B13, Baseband Main Module 2x K62, AWGN

### Edit Mode - Test Case Wizard - 3GPP FDD

Selects the edit mode.

**According to Standard** Only settings in compliance with TS 25.141 are possible in the wizard panel.

Remote-control command:  
SOUR:BB:W3GP:TS25141:EMOD STAN

**User Definable** A wider range of settings is possible in the wizard panel.

Remote-control command:  
SOUR:BB:W3GP:TS25141:EMOD USER

### Trigger Configuration - Test Case Wizard - 3GPP FDD

Selects the trigger configuration. The trigger is used to synchronize the signal generator to the other equipment.

**Auto** The trigger settings are customized for the selected test case. In most cases trigger setting **Armed Auto** with external trigger source **External Trigger 1** is used. Unless otherwise noted the trigger delay is set equal to zero. Thus, the base station frame timing is able to synchronize the signal generator by a SFN (System Frame Number) periodic trigger. If the signal generator offers a channel coded signal (as all the Reference Measurements Channels require) the base station must emit a 'SFN mod 4' periodic trigger.

Remote-control command:  
SOUR:BB:W3GP:TS25141:TRIG AUTO

**Unchanged** The current trigger settings of the signal generator are retained unchanged.

Remote-control command:  
SOUR:BB:W3GP:TS25141:TRIG PRES

**Marker Configuration - Test Case Wizard - 3GPP FDD** Selects the marker configuration. The marker can be used to synchronize the measuring equipment to the signal generator.

**Auto** The marker settings are customized for the selected test case. In most cases **Radio Frame** markers are output. Unless otherwise noted the marker delays are set equal to zero.

Remote-control command:  
`SOUR:BB:W3GP:TS25141:TRIG:OUTP AUTO`

**Unchanged** The current marker settings of the signal generator are retained unchanged.

Remote-control command:  
`SOUR:BB:W3GP:TS25141:TRIG:OUTP PRES`

**Diversity - Test Case Wizard - 3GPP FDD** (only for two-path instruments and if supported by the selected test case). Selects the signal routing according to the base station's diversity processing capability.

**ON** The test signal is routed to both RF outputs.

Remote-control command:  
`SOUR:BB:W3GP:TS25141:RXD ON`

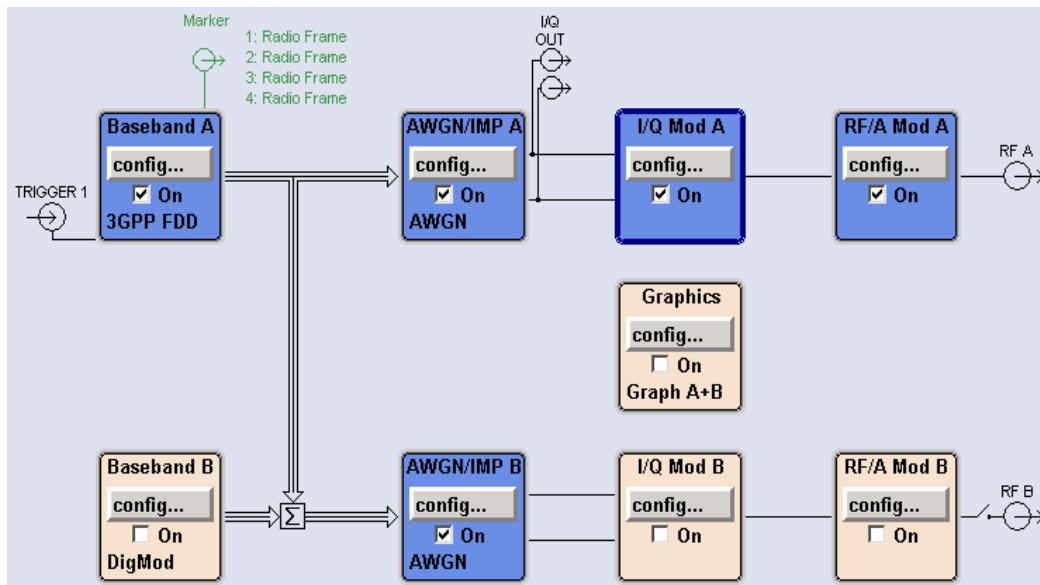

**Off** The test signal is routed to the selected RF output.

Remote-control command:  
`SOUR:BB:W3GP:TS25141:RXD OFF`

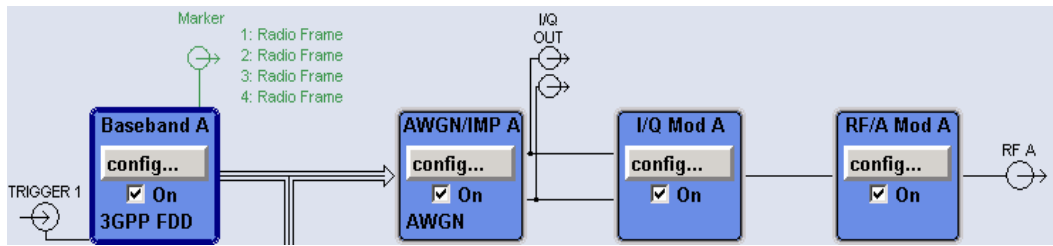

**Baseband A Signal Routing - Test Case Wizard - 3GPP FDD** (only for two-path instruments) Selects the signal routing for baseband A signal which in most test cases represents the wanted signal (exception test case 6.6).

**A** The baseband signal A is routed to RF output A.

Remote-control command:  
`SOUR:BB:W3GP:TS25141:ROUT A`

**B** The baseband signal A is routed to RF output B.

Remote-control command:  
`SOUR:BB:W3GP:TS25141:ROUT B`

## Basestation Configuration - Test Case Wizard - 3GPP FDD

**Scrambling Code (hex) - Test Case Wizard - 3GPP FDD** Enters the scrambling code.  
 Remote-control command:  
`SOUR:BB:W3GP:TS25141:SCOD #H5FFF`

**Scrambling Mode - Test Case Wizard - 3GPP FDD** Sets the type of scrambling code.  
 With scrambling code, a distinction is made between **Long** and **Short Scrambling Code** for uplink signals. For downlink signals (test case 6.6) the scrambling code generator can be switched on and off.

**On (downlink only)** Enables scrambling code generator.  
 Remote-control command:  
`SOUR:BB:W3GP:TS25141:SCOD:MODE ON`

**Off** Disables scrambling code generator for test purposes.  
 Remote-control command:  
`SOUR:BB:W3GP:TS25141:SCOD:MODE OFF`

<b>Long Scrambling Code (uplink only)</b>	Sets the long scrambling code. Remote-control commands: SOUR:BB:W3GP:TS25141:SCOD:MODE LONG
<b>Short Scrambling Code (uplink only)</b>	Sets short scrambling code. Remote-control command: SOUR:BB:W3GP:TS25141:SCOD:MODE SHOR

### Power Class - Test Case Wizard - 3GPP FDD

(only for 'According to Standard', not for transmitter test case 6.6)  
Enters the base station power class. The selected power class determines the output level of the signal generator. The output level is indicated in the **Wanted Signal** section of the Wizard panel.

The following selection is available:

- **Wide Area BS**
- **Medium Range BS**
- **Local Area BS**

For edit mode "User Definable", the output level can be set in the **Wanted Signal** section of the Wizard panel.

Remote-control command:  
SOUR:BB:W3GP:TS25141:BSPC MED

## Apply - Test Case Wizard - 3GPP FDD

### Apply Settings

Activates the current settings of the test case wizard.

Initialization of the signal generator with the test case settings is performed by a partial reset that includes only the baseband and AWGN module and the RF frequency and RF level settings. Other settings of the signal generator are not altered.

Before triggering the signal generator the user still can change these other settings. This is particularly useful when compensating for cable loss and additionally inserted attenuators by adjusting the RF power levels is required.

Signal generation is started at the first trigger received by the generator. The RF output is not activated /deactivated by the test case wizard, so care has to be taken that **RF State** is **On** at the beginning of the measurement.

---

#### Note:

*For safety reasons the RF is not active unless the button **RF ON** has been pressed.*

---

Remote-control command:  
SOUR:BB:W3GP:TS25141:TCAS:EXEC

# Transmitter Tests - 3GPP FDD

## Basic Configuration - Transmitter Tests - 3GPP FDD

The test cases for transmitter tests require at least the following equipment layout for the signal generator:

- Digital Standard 3GPP FDD (K42)
- Universal Coder / Arbitrary Waveform Generator (B10/B11),
- Baseband Main module (DACIF; B13),
- Frequency option (B10x: RF 100 kHz - x GHz).

Transmitter tests always require a separate measuring equipment to perform the tests, e.g. the Vector Signal Analyzer R&S FSQ.

Test cases where the signal generator hardware equipment is not sufficient are shown in grey color but are not selectable. RF power and frequency limitations of the hardware equipment restrict the setting ranges.

## Test Case 6.4.2 - Power Control Steps

The test case requires the basic configuration.

It can be performed using the standard test setup according to TS 25.141. A vector signal analyzer is required, e.g. the Vector Signal Analyzer R&S FSQ.

For the signal generator, in case of two-path instruments signal routing to path A is assumed.

Output RF A of the signal generator is connected to the Rx port of the base station. The Tx Signal of the base station is connected to the RF input of the analyzer via an attenuator.

The signal generator will start signal generation at the first BS frame trigger sent to input **Trigger 1**. The analyzer is triggered by a marker signal (MARKER 1) of the generator.

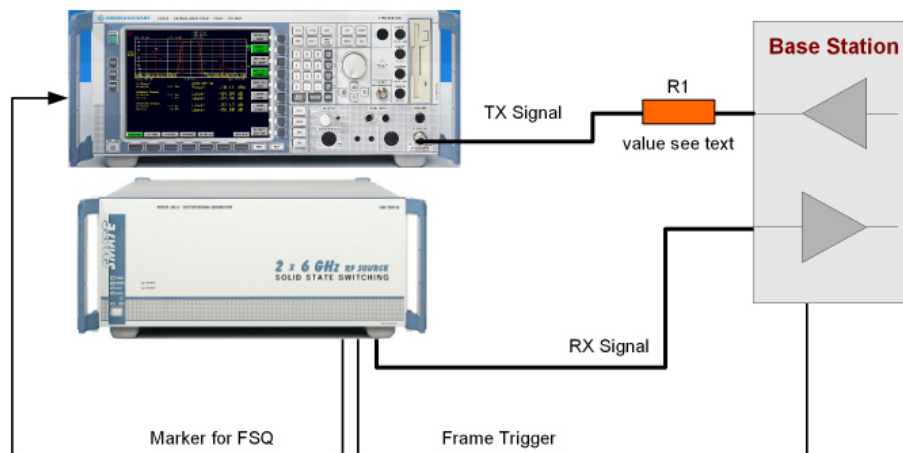

The signal generator provides an uplink link signal with a precisely defined TPC bit sequence. The base station responds to the TPC bits by controlling the transmitted power of the data channel which is checked by the analyzer.

The analyzer measures the base station transmit power in the code domain to verify the transmitter power control step tolerance and aggregated power control step range.

**Test Purpose and Test Settings - Test Case 6.4.2**

The test case verifies that a BS receiver has the capability to adjust its transmit power in response to the uplink TPC pattern. The cumulative power change as a result of ten successive (identical) TPC bits is also checked (aggregated transmit power).

The test is passed when the single or aggregated power control steps are within tolerance throughout the total dynamic range at the test frequencies B, M, and T.

Quotation from TS 25.141:

*The power control step is the required step change in the code domain power of a code channel in response to the corresponding power control command. The combined output power change is the required total change in the DL transmitter output power of a code channel in response to multiple consecutive power control commands corresponding to that code channel.*

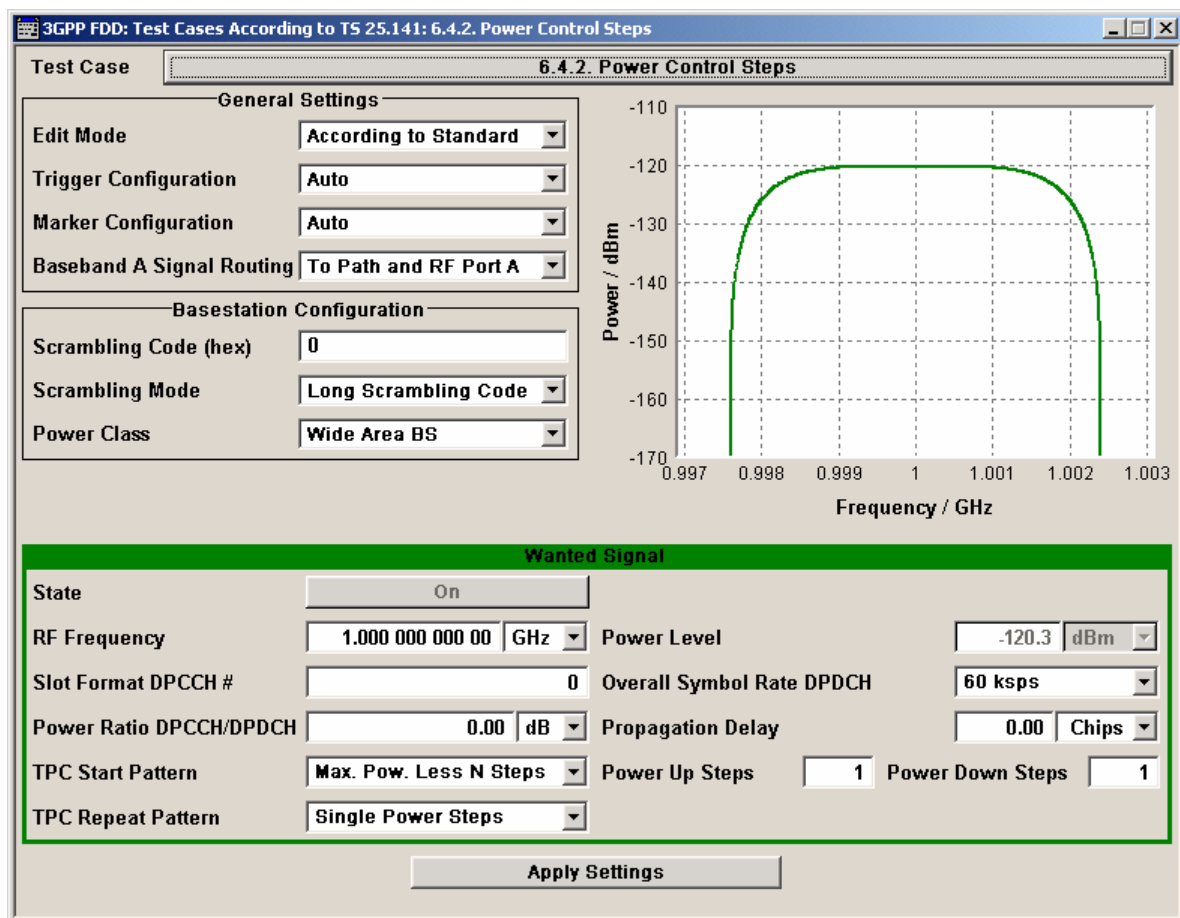

- Wanted Signal State - Test Case 6.4.2** Enables/disables the signal generation of the wanted 3GPP signal.  
In edit mode '**According to Standard**' the state is fixed to '**On**'.  
Remote-control command:  
SOUR:BB:W3GP:TS25141:WSIG:STAT ON | OFF
- Wanted Signal Frequency - Test Case 6.4.2** Sets the RF frequency of the wanted signal.  
Remote-control command:  
SOUR:BB:W3GP:TS25141:WSIG:FREQ 100.0 kHz
- Wanted Signal Level - Test Case 6.4.2** Sets the RF level in edit mode '**User Definable**'.  
In edit mode '**According to Standard**' the RF level is determined by the selected **Power Class**. It is always 10 dBm above the reference sensitivity.
- **-120.3 dB + 10 dBm** when **Wide Area BS**
  - **-110.3 dB + 10 dBm** when **Medium Range BS**
  - **-106.3 dB + 10 dBm** when **Local Area BS**
- Remote-control command:  
SOUR:BB:W3GP:TS25141:WSIG:POW -45.0 dBm
- Slot Format DPCCH - Test Case 6.4.2** Selects the slot format.  
Slot formats 0 to 5 are available for the DPCCH channel. The slot format defines the FBI mode and the TFCI status.
- Slot format 0:** no FBI field / TFCI on  
**Slot format 1:** no FBI field / TFCI off  
**Slot format 2:** 1 FBI field / TFCI on  
**Slot format 3:** 1 FBI field / TFCI off  
**Slot format 4:** 2 FBI field / TFCI off  
**Slot format 5:** 2 FBI field / TFCI on
- Remote-control command:  
SOUR:BB:W3GP:TS25141:WSIG:DPCC:SFOR 4
- Overall Symbol Rate - Test Case 6.4.2** Sets the overall symbol rate of all the DPDCH channels.  
The structure of the DPDCH channel table depends on this parameter. The overall symbol rate determines which DPDCHs are active, which symbol rate they have and which channelization codes they use.  
Remote-control command:  
SOUR:BB:W3GP:TS25141:WSIG:DPDC:ORAT D60K



**Power Ratio DPCCH to DPDCH - Test Case 6.4.2**

Sets the channel power ratio of DPCCH to DPDCH.

Remote-control command:

```
SOUR:BB:W3GP:TS25141:WSIG:DCR -3.0dB
```

**Propagation Delay - Test Case 6.4.2**

Sets an additional propagation delay besides the fixed DL-UL timing offset of 1024 chip periods.

**Note:**

*The additional propagation delay is achieved by charging the start trigger impulse with the respective delay (= entering the value as an **External Delay** in the 3GPP Trigger /Marker menu).*

Remote-control command:

```
SOUR:BB:W3GP:TS25141:WSIG:TRIG:EXT:DEL 140
```

**TPC Start Pattern - Test Case 6.4.2**

Sets the TPC pattern for initialization of the base stations power level in edit mode '**User Definable**'. The TPC start pattern is sent before the TPC repeat pattern.

In edit mode '**According to Standard**' the pattern is fixed to '**Maximum Power Less n Steps**'.

**Note:**

*In edit mode '**According to Standard**', the TPC bits are read out of predefined data lists.*

The TPC start pattern ensures that the base station responds reliably to the TPC bits from the generator. It sets the base station to a defined initial state for the actual recording of the measurement data. The analyzer is only triggered after the generation of the start pattern using marker 1 of the generator.

**Maximum Power Less n Steps**

A sequence of power up steps (TPC bits "1") is followed by a number of power down steps (TPC bits "0").

A sufficiently long sequence of TPC bits "1" ('power up' commands) forces the base station to maximum transmit power. By the n 'power down' commands the base station is set to a defined number of n power steps (e.g. 1 dB or 0.5 dB) below its maximum transmit power at the beginning of the measurement.

Remote-control command:

```
SOUR:BB:W3GP:TS25141:WSIG:DPCC:TPC:SDAT  
PMAx
```

**Data List**

The TPC start pattern is taken from a user defined data list. When **Data List** is selected, a button appears for calling the **File Select** window.

Remote-control commands:

```
SOUR:BB:W3GP:TS25141:WSIG:DPCC:TPC:SDAT  
DLIS  
SOUR:BB:W3GP:TS25141:WSIG:DPCC:TPC:SDAT:  
DSEL "TS642_TPC_PATT"
```

**TPC Power Up Steps - Test Case 6.4.2** Sets the number of power up bits ("1") in the TPC start pattern. The total TPC start pattern length is the number of 'power up' bits plus the number of n 'power down' bits.

This parameter is only available for TPC Start Pattern = **Max. Pow. Less N Steps**.

Remote-control command:

SOUR:BB:W3GP:TS25141:WSIG:DPCC:TPC:SDAT:PUST 4

**TPC Power Down Steps - Test Case 6.4.2** Sets the number of power down bits ('0') in the TPC start pattern. The total TPC start pattern length is the number of 'power up' ('1') bits plus the number of n 'power down' ('0') bits.

This parameter is only available for TPC Start Pattern = **Max. Pow. Less N Steps**.

Remote-control command:

SOUR:BB:W3GP:TS25141:WSIG:DPCC:TPC:SDAT:PDST 2

**TPC Repeat Pattern - Test Case 6.4.2** Sets the TPC pattern for verification of the base stations power control steps.

In edit mode '**According to Standard**' the selection is limited.

**Single Power Steps** A 01 pattern is sent periodically for measurement of the transmitter power control step tolerance.

Remote-control command:

SOUR:BB:W3GP:TS25141:WSIG:DPCC:TPC:RDAT SING

**Aggregated Power Steps** A 0000000001111111111 pattern is sent periodically for measurement of the transmitter aggregated power control step range. The power of the base station is measured after 10 consecutive equal TPC bits ('1' or '0').

Remote-control command:

SOUR:BB:W3GP:TS25141:WSIG:DPCC:TPC:RDAT AGGR

**(All 1) Maximum Power** A all 1 pattern is sent continuously. The base station is forced to maximum power. This selection is only available in edit mode '**User Definable**'

Remote-control command:

SOUR:BB:W3GP:TS25141:WSIG:DPCC:TPC:RDAT ONE

**(All 0) Minimum Power** A all 0 pattern is sent continuously. The base station is forced to minimum power. This selection is only available in edit mode '**User Definable**'

Remote-control command:

SOUR:BB:W3GP:TS25141:WSIG:DPCC:TPC:RDAT ZERO

**User Defined Pattern**

The TPC repeat pattern can be input. When **User Defined Pattern** is selected, an input field appears for entering the pattern. The maximum bit pattern length is 64 bits. This selection is only available in edit mode '**User Definable**'

Remote-control command:

```
SOUR:BB:W3GP:TS25141:WSIG:DPCC:TPC:RDAT PATT
SOUR:BB:W3GP:TS25141:WSIG:DPCC:TPC:RDAT:PATT #H3F,8
```

**Data List**

The TPC repeat pattern is taken from a data list. When **Data List** is selected, a button appears for calling the **File Select** window.

Remote-control commands:

```
SOUR:BB:W3GP:TS25141:WSIG:DPCC:TPC:RDAT DLIS
SOUR:BB:W3GP:TS25141:WSIG:DPCC:TPC:RDAT:DSEL "TS642_TPC_RPATT"
```

**Carrying Out the Test Case 6.4.2 Measurement**

For the preset Marker Configuration **Auto**, Marker 1 starts delayed by the TPC start pattern length.

Each slot takes 0.625 ms and consists of 2560 chips. Depending on the slot format 1 or 2 TPC bits are sent for each slot.

The following table lists the settings on the base station:

Parameter	Value
Frequency	B, M and T
Test Model	2
Transmit power	Any
Scrambling Code	Any

1. Set the base station to the basic state
  - Initialize the base station,
  - Set the scrambling scheme,
  - Set the base station to test model 2,
  - Set the frequency
  
2. Set the signal generator to the basic state
  - Preset the signal generator unless some settings (e.g. in terms of I/Q and RF blocks) have to be kept.
  
3. Set the analyzer to the basic state
  - Set the test case wizard
  - Open the 3GPP FDD menu in the baseband block
  - Open the Test Case Wizard and select Test Case 6.4.2.  
The General Settings parameters are preset according to TS 25.141
  - Enter scrambling code and scrambling mode according to the base station scrambling scheme.

- Enter the power class of the base station under test. The RF level is automatically adjusted to the selected power class.
  - Enter the test frequency (e.g. M). It must be the same as the base station has been set to.
  - Enter the Wanted Signal parameters.
  - Activate the settings with the Apply Settings button.  
The signal generator is now ready to start signal generation
4. Set the analyzer to the measurement frequency
  5. Switch on RF output
  6. Start the measurement
    - Send a start trigger impulse from the base station to the signal generator and to the analyzer. Signal generation and measurement procedures are started.
  7. Calculate the result  
The analyzer calculates the resulting code domain power of the BS downlink channel.

## Test Case 6.6 - Transmit Intermodulation

The test case requires the basic configuration.

It can be performed using the standard test setup according to TS 25.141. A vector signal analyzer is required, e.g. the Vector Signal Analyzer R&S FSQ.

For the signal generator, in case of two-path instruments signal routing to path A is assumed.

RF port A is connected to the RF input of the analyzer via a circulator and an external attenuator. The Tx Signal of the base station is connected to the RF input of the analyzer via a circulator.

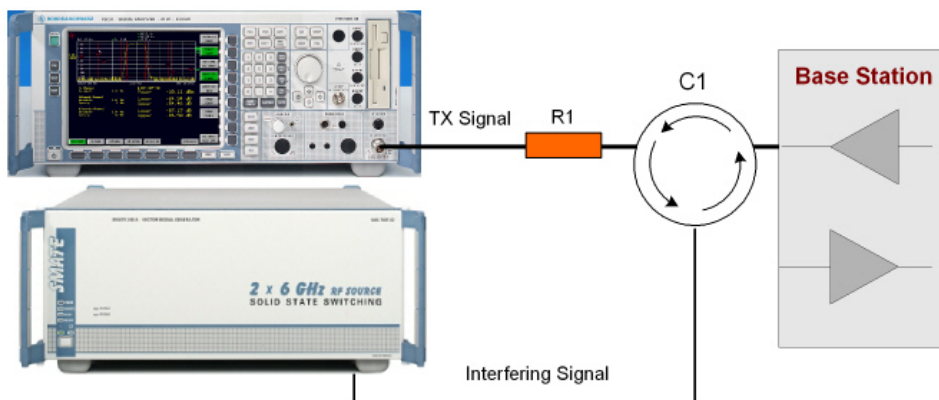

The signal generator outputs the test model interfering signal with different frequency offsets in relation to the BS carrier frequency and provides the trigger for the analyzer (MARKER 1).

### Test Purpose and Test Settings - Test Case 6.6

The test case verifies that a BS transmitter has the capability to inhibit intermodulation products of non linear elements caused by the presence of an interfering signal at the adjacent frequency channels from the signal generator.

The test is passed when the transmit intermodulation level is below an upper out of band emission and spurious emission threshold at the test frequencies B, M, and T.

Quotation from TS 25.141:

*The transmit intermodulation performance is a measure of the capability of the transmitter to inhibit the generation of signals in its non linear elements caused by presence of the wanted signal and an interfering signal reaching the transmitter via the antenna*

*The transmit intermodulation level is the power of the intermodulation products when a WCDMA modulated interference signal is injected into an antenna connector at a mean power level of 30 dB lower than that of the mean power of the wanted signal. The frequency of the interference signal shall be 5 MHz, 10 MHz and 15 MHz offset from the subject signal carrier frequency, but exclude interference frequencies that are outside of the allocated frequency band for UTRA-FDD downlink specified in subclause 3.4.1.*

*The requirements are applicable for single carrier.*

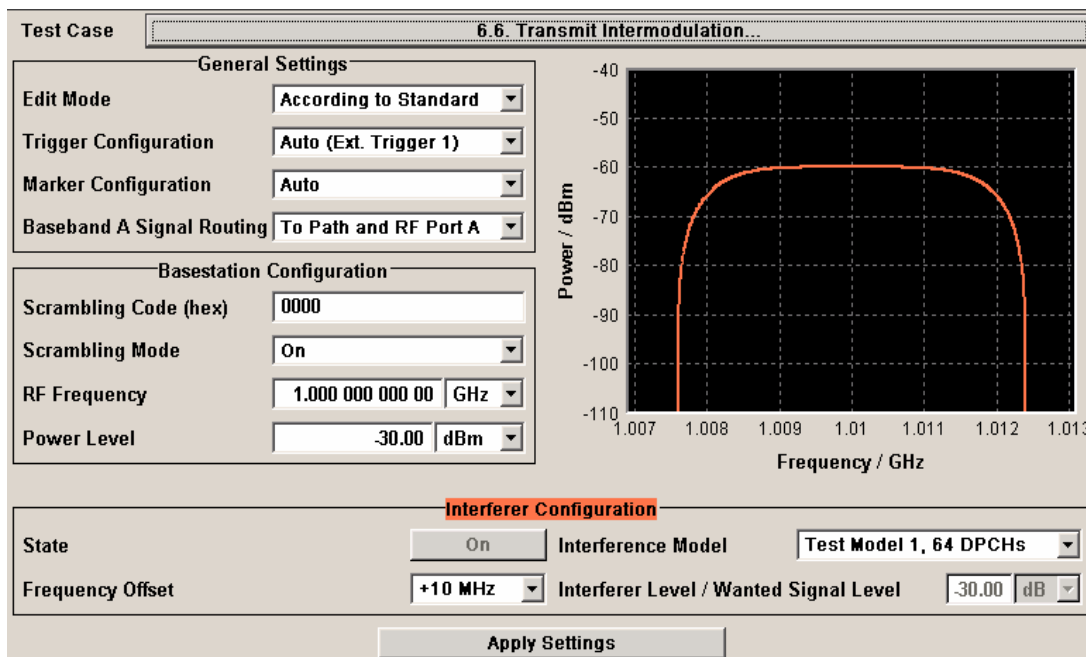

### BS Frequency - Test Case 6.6

Enters the RF frequency of the base station.

Note:

*In this test case the signal generator generates no wanted signal, but just the interfering signal.*

Remote-control command:

```
SOUR:BB:W3GP:TS25141:BSS:FREQ 1GHz
```

<b>BS RF Power - Test Case 6.6</b>	<p>Enters the RF power of the base station.</p> <hr/> <p><i>Note:</i>  <i>In this test case the signal generator generates no wanted signal, but just the interfering signal.</i></p> <hr/> <p>Remote-control command:  SOUR:BB:W3GP:TS25141:BSS:POW -30</p>
<b>Interferer State - Test Case 6.6</b>	<p>Enables/disables the signal generation of the interfering 3GPP signal. In edit mode '<b>According to Standard</b>' the state is fixed to '<b>On</b>'.</p> <hr/> <p><i>Note</i>  <i>In this test case the signal generator generates no wanted signal, but just the interfering signal .</i></p> <hr/> <p>Remote-control command:  SOUR:BB:W3GP:TS25141:IFS:STAT ON</p>
<b>Interferer Mode - Test Case 6.6</b>	<p>Selects the interfering signal from a list of test models in accordance with TS 25.141. All test models refer to the predefined downlink configurations. In edit mode '<b>According to Standard</b>' Test Model 1, 64 DPCHs is fixed.</p> <p>The following test models are available for selection in edit mode '<b>User Definable</b>':</p> <ul style="list-style-type: none"> <li>- Test Model 1; 64 DPCHs</li> <li>- Test Model 1; 16 Channels</li> <li>- Test Model 1; 32 Channels</li> <li>- Test Model 2</li> <li>- Test Model 3; 16 Channels</li> <li>- Test Model 3; 32 Channels</li> <li>- Test Model 4</li> <li>- Test Model 5; 38 Channels</li> <li>- Test Model 5; 28 Channels</li> <li>- Test Model 5; 8 Channels</li> </ul> <p>Remote-control command:  SOUR:BB:W3GP:TS25141:IFS:SETT:TMOD:BST TM164</p>
<b>Frequency Offset - Test Case 6.6</b>	<p>Enters the frequency offset of the interfering signal versus the wanted signal.</p> <p>In edit mode '<b>According to Standard</b>' the choice is limited to values between +/- 15 MHz in 5-MHz steps:</p> <p>Remote-control command:  SOUR:BB:W3GP:TS25141:IFS:FOFF -15 MHz</p>

**Interferer Level to Signal Level - Test Case 6.6**

Enters the ratio of interfering signal level versus wanted signal level.

In edit mode '**According to Standard**' the value is fixed to - 30 dB:

Remote-control command:

SOUR:BB:W3GP:TS25141:IFS:CNR -30

**Carrying Out a Test Case 6.6 Measurement**

The signal generator outputs the test model interfering signal.

The following table lists the settings on the base station:

Parameter	Value
Frequency	B, M and T
Test Model	1
Transmit power	Maximum
Scrambling Code	any

1. Set the base station to the basic state
  - Initialize the base station,
  - Set the scrambling scheme,
  - Set the base station to test model 1,
  - Set maximum transmit power,
  - Set the frequency
2. Set the signal generator to the basic state
  - Preset the signal generator unless some settings (e.g. in terms of I/Q and RF blocks) have to be kept.
3. Set the analyzer to the basic state
4. Set the test case wizard
  - Open the 3GPP FDD menu in the baseband block
  - Open the Test Case Wizard and select Test Case 6.6.  
The **General Settings** parameters are preset according to TS 25.141
  - Enter scrambling code and scrambling mode according to the base station scrambling scheme.
  - Enter the power class of the base station under test. The RF level is automatically adjusted to the selected power class.
  - Enter the test frequency (e.g. M). It must be the same as the base station has been set to.
  - Enter the Interfering Signal parameters.
  - Activate the settings with the Apply Settings button.  
The signal generator is now ready to start signal generation
5. Set the analyzer to the measurement frequency
6. Switch on RF output

7. Start the measurement
  - Send a start trigger impulse from the base station to the signal generator and to the analyzer. Signal generation and measurement procedures are started.
8. Calculate the result
 

The analyzer calculates the out of band emission and the spurious emission.

## Overview - Receiver Tests - 3GPP FDD

### Basic Configuration - Receiver Tests - 3GPP FDD

The test cases for receiver tests require at least the following equipment layout for the signal generator:

- Digital Standard 3GPP FDD (K42)
- Universal Coder / Arbitrary Waveform Generator (B10/B11),
- Baseband Main module (B13),
- Frequency option (B10x: RF 100 kHz - x GHz).

If the test case requires further options they are listed together with the description of the test case.

Receiver test can be performed with the signal generator only, i.e. without additional measuring equipment.

### Test Setups - Receiver Tests - 3GPP FDD

The tests can be performed using the standard test setup according to TS 25.141. Test setups beside the two standard test setups described below are specified at the Test Case description.

#### Standard Test Setup - One Path

In case of two-path instruments signal routing to path A is assumed for the graph below. RF port A outputs the wanted signal (with or without interference) and is connected to the Rx port of the base station. The signal generator will start signal generation at the first BS frame trigger sent to input **Trigger 1**.

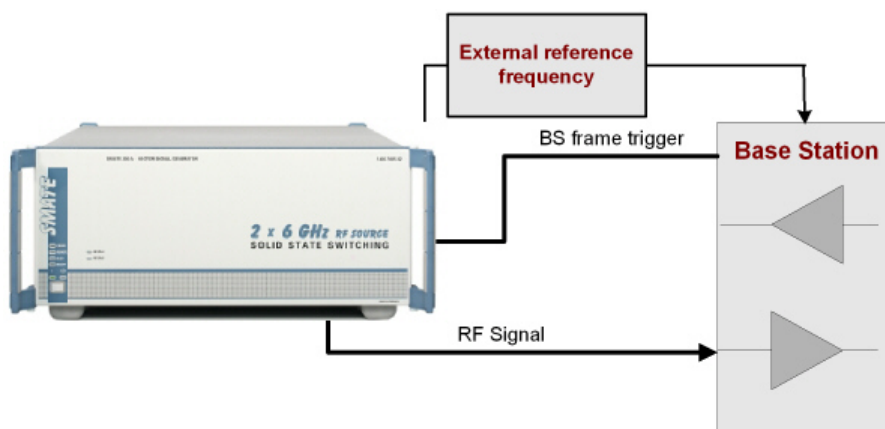



For two-path instruments it is also possible to route baseband signal A to RF output B and connect RF output B to the Rx port of the base station.

Example: Signal Routing To Path and RF port A for test case 8.8.1 RACH Preamble Detection in Static Propagation Conditions:

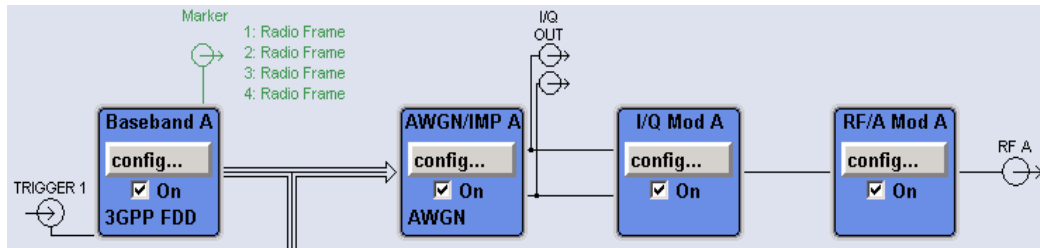

**Standard Test Setup - Two Paths**

For **two-paths measurements**, the test cases always require option Second RF path (B20x), a second option Baseband Main Module (B13) and at least one option to generate the interfering signal in addition to the basic configuration. The signal routing can be selected, the wanted signal can be provided either at output RF A or at output RF B.

The signal generator outputs the reference measurement channel signal (= wanted signal) at output RF A and the interfering signal(s) at output RF B. After combining the two(three) signals the sum signal is fed into the base station Rx port. The signal generator will start signal generation at the first BS frame trigger sent to input **Trigger 1**.

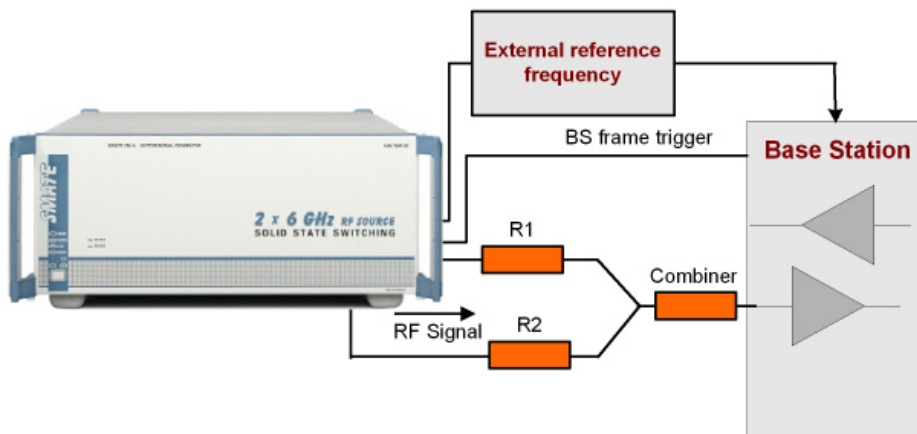

Example: Signal Routing To Path and RF port A for test case 7.6 Intermodulation Characteristics:

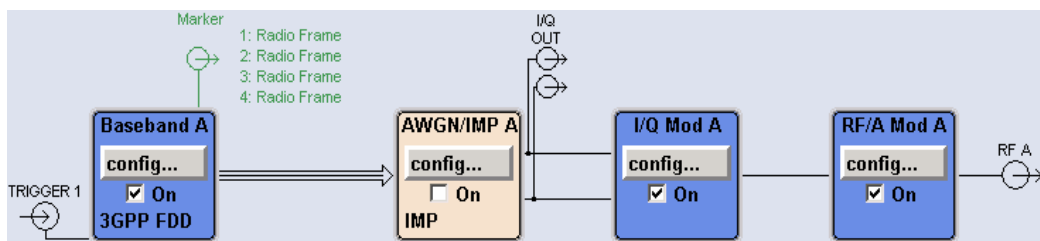

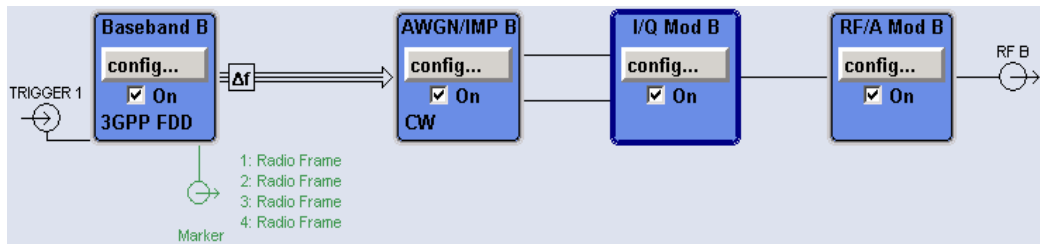

**Standard Test Setup - Diversity Measurements**

For **diversity measurements**, the test cases always require at least option Second RF path (B20x) and a second option Baseband Main Module (B13) in addition to the basic configuration. The signal routing is fixed.

RF output A and RF output B transmit the corrupted reference measurement channel signal (wanted signal) and are connected to the Rx ports of the base station for diversity reception. The signal generator will start signal generation at the first BS frame trigger sent to input **Trigger 1**.

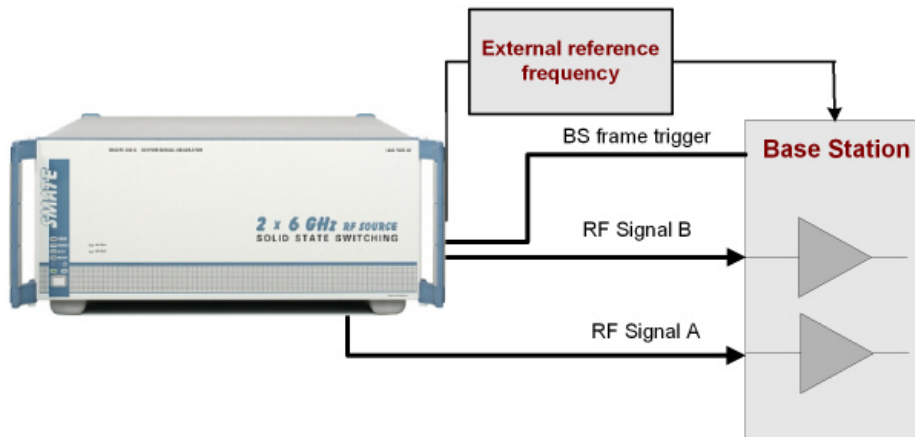

Example: Signal Routing for test case 8.9.3 Demodulation of CPCH Message in Static Propagation Conditions:

**Note:**

*As signal routing takes place at the output of the baseband block, the interference settings of the two paths are identical for diversity measurements.*

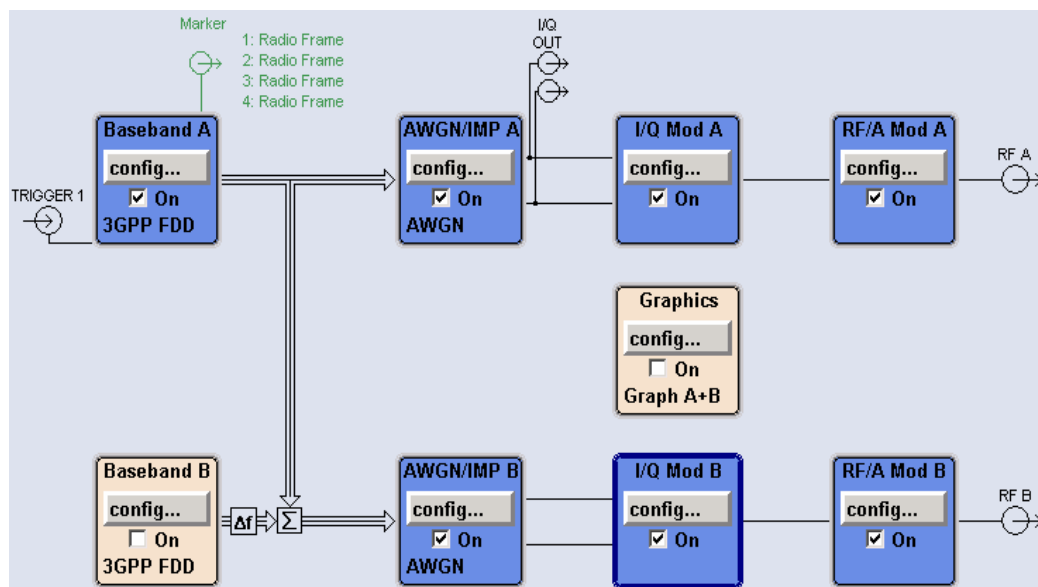

## Carrying Out a Receiver Test Measurement

The following instructions lists the general steps for performing a receiver test. Specific requirements are described together with the individual test case.

1. Set the base station to the basic state
  - Initialize the base station,
  - Set the scrambling scheme,
  - Set the frequency
  - Set the base station to receive the Reference Measurement Channel (for most test cases),
2. Set the signal generator to the basic state
  - Preset the signal generator.
3. Set the test case wizard
  - Open the 3GPP FDD menu in the baseband block
  - Open the Test Case Wizard and select Test Case  
The General Settings parameters are preset according to TS 25.141
  - Enter scrambling code and scrambling mode according to the base station scrambling scheme.
  - Enter additional required parameters, e.g. power class of base station.
  - Enter the test frequency (e.g. M). It must be the same as the base station has been set to.
  - Activate the settings with the **Apply Settings** button.  
The signal generator is now ready to start signal generation
4. Switch on RF output
5. If required, make additional settings (e.g. in the I/Q Mod or RF block) or change test case settings
6. Start the measurement
  - Send a start trigger impulse (e.g. SFN modulo 4) from the base station to the signal generator.  
The signal generator will start signal generation.

- Calculate the result  
The base station internally calculates the BER, BLER or Pd depending on the test case. This value is compared to the required value.

## General Wanted Signal Parameters - Receiver Tests - 3GPP FDD

The following parameters are available for all receiver tests. Specific parameters are listed together with the Test Case description.

**Wanted Signal State - Receiver Tests** Enables/disables the signal generation of the wanted 3GPP signal.  
In edit mode '**According to Standard**' the state is fixed to '**On**'.  
Remote-control command:  
SOUR:BB:W3GP:TS25141:WSIG:STAT ON | OFF

**RMC - Receiver Tests** Sets the reference measurement channel.  
In edit mode '**According to Standard**' the selection of the reference measurement channel is restricted.  
In edit mode '**User definable**', all following reference measurement channels are available for selection:

- **RMC 12.2 kbps** 12.2 kbps measurement channel
- **RMC 64 kbps** 64 kbps measurement channel
- **RMC 144 kbps** 144 kbps measurement channel
- **RMC 384 kbps** 384 kbps measurement channel
- **AMR 12.2 kbps** channel coding for the AMR coder

Remote-control command:  
SOUR:BB:W3GP:TS25141:WSIG:DPDC:CCOD:TYPE M12K2

**Wanted Signal Frequency - Receiver Tests** Sets the RF frequency of the wanted signal.  
Remote-control command:  
SOUR:BB:W3GP:TS25141:WSIG:FREQ 100.0 kHz

**Wanted Signal Level - Receiver Tests** Sets the RF level in edit mode '**User Definable**'.  
In edit mode '**According to Standard**' the RF level is determined by the selected **Power Class**.  
Remote-control command:  
SOUR:BB:W3GP:TS25141:WSIG:POW -45.0

# Receiver Characteristics - Receiver Tests - 3GPP FDD

## Test Case 7.2 - Reference Sensitivity Level

The test case requires the basic configuration and is performed using the standard test setup for one path. The signal generator outputs a reference measurement channel signal.

The following table lists the settings on the base station:

Parameter	Value
Frequency	B, M and T
RMC	12.2 kbps
Scrambling code	Any
TPC function	OFF

### Test Purpose and Test Settings - Test Case 7.2

The test case verifies that a BS receiver has the capability to correctly demodulate the signal sent by the signal generator at the specified (low) reference sensitivity power level.

The test is passed when the resulting BER (calculated internally by the BS) is below a 0.001 at the test frequencies B, M, and T. Note TS 25.141 Annex C: General Rules for Statistical Testing, where test conditions in terms of test methods and test conditions are defined.

Quotation from TS 25.141:

*The reference sensitivity level is the minimum mean power received at the antenna connector at which the BER shall not exceed the specific value indicated in subclause 7.2.2. The test is set up according to Figure B.7 and performed without interfering signal power applied to the BS antenna connector. For duplex operation, the measurement configuration principle is indicated for one duplex branch in Figure B.7. For internal BER calculation an example of the test connection is as shown in figure B.7. The reference point for signal power is at the input of the receiver (antenna connector).*

The measurement must be made at the three frequencies B, M and T.

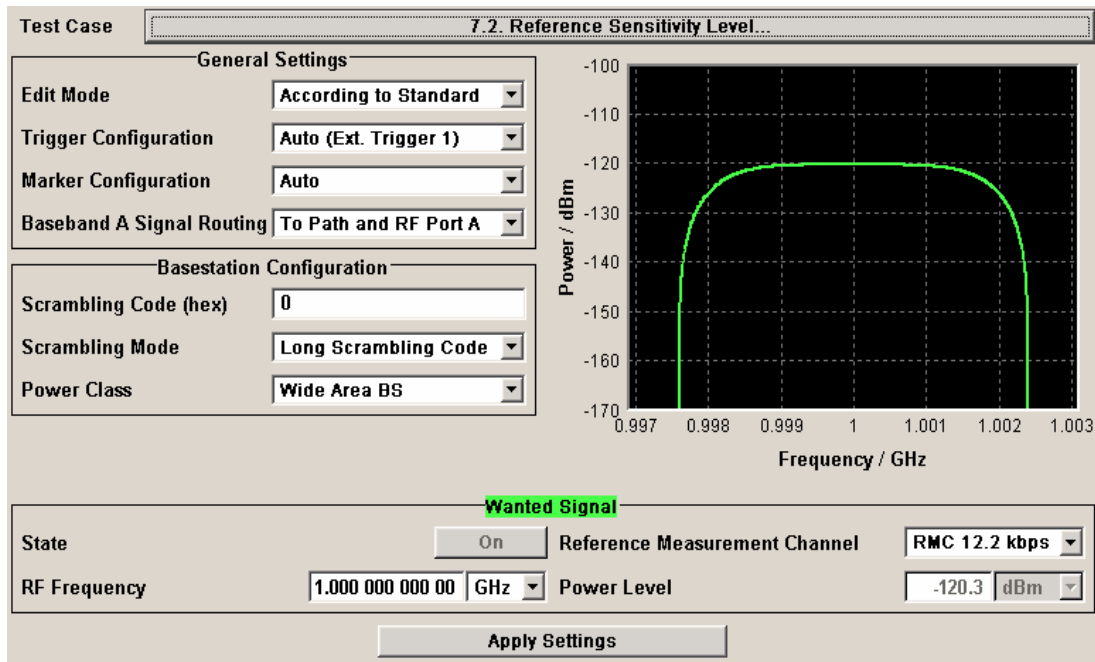

The settings of the wanted signal are described in section "[General Wanted Signal Parameters - Receiver Tests - 3GPP FDD](#)", on page 4.504.

## Test Case 7.3 - Dynamic Range

The test case is performed using the standard test setup for one path.

It requires option K62 - Additional White Gaussian Noise (AWGN) in addition to the basic configuration.

The signal generator outputs a reference measurement channel signal disturbed by an interfering AWGN signal.

The following table lists the settings on the base station:

Parameter	Value
Frequency	B, M and T
RMC	12.2 kbps
Scrambling code	Any

### Test Purpose and Test Settings - Test Case 7.3

The test case verifies that a BS receiver has the capability to demodulate the useful signal sent by the signal generator even when it is superimposed by a heavy AWGN (Additive White Gaussian Noise) signal.

The test is passed when the resulting BER (calculated internally by the BS) is below 0.001 at the test frequencies B, M, and T. Note TS 25.141 Annex C: General Rules for Statistical Testing, where test conditions in terms of test methods and test conditions are defined.

Quotation from TS 25.141:

*Receiver dynamic range is the receiver ability to handle a rise of interference in the reception frequency channel. The receiver shall fulfil a specified BER requirement for a specified sensitivity degradation of the wanted signal in the presence of an interfering AWGN signal in the same reception frequency channel.*

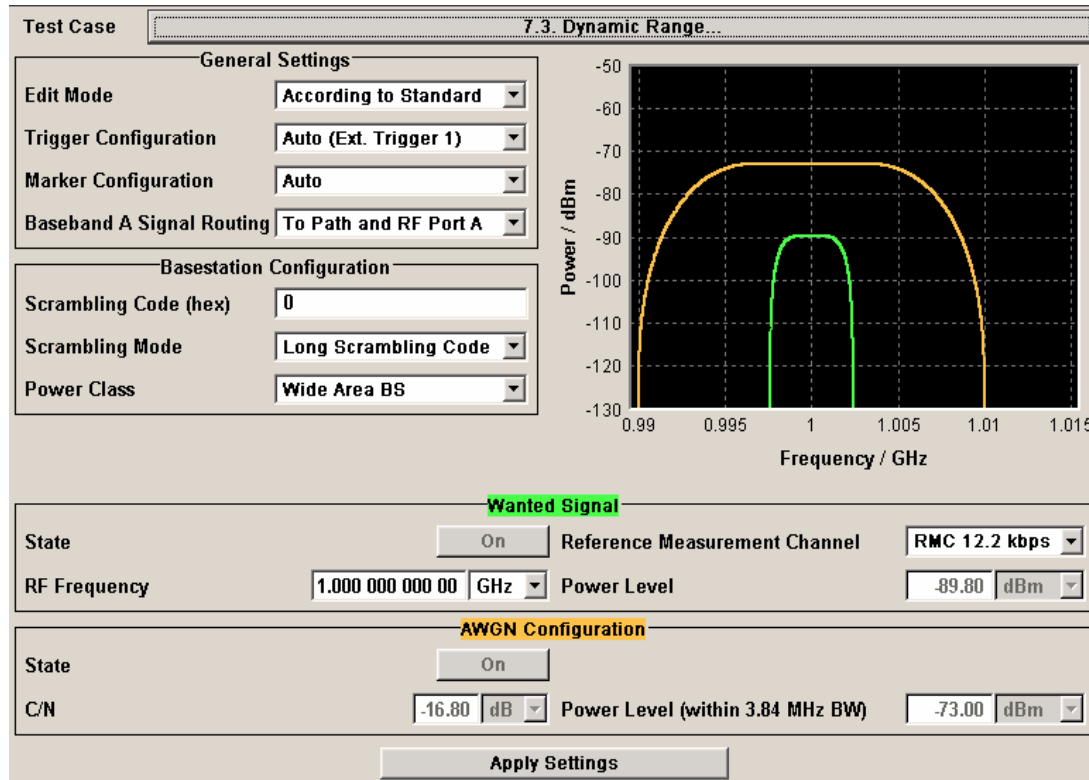

Besides the settings described for all receiver tests, AWGN configuration is possible in edit mode "User Definable". In edit mode 'According to Standard' the AWGN settings are preset:

**AWGN State - Test Case 7.3**

Enables/disables the generation of the AWGN signal.

In edit mode 'According to Standard' the state is fixed to 'On'.

Remote-control command:

SOUR:BB:W3GP:TS25141:AWGN:STAT ON | OFF

**C to N - Test Case 7.3**

Sets the carrier/noise ratio.

In edit mode 'According to Standard' the state is fixed to '-16.8 dB'.

Remote-control command:

SOUR:BB:W3GP:TS25141:AWGN:CNR -14dB

**Power Level - Test Case 7.3** (within 3.84 MHz BW) Sets the AWGN level in edit mode 'User Definable'.

In edit mode 'According to Standard' the AWGN level is determined by the selected **Power Class** .

- **-73 dB** for **Wide Area BS**
- **-63 dB** for **Medium Range BS**
- **-59 dB** for **Local Area BS**

Remote-control command:

SOUR:BB:W3GP:TS25141:AWGN:POW:NOIS -45.0 dBm

## Test Case 7.4 - Adjacent Channel Selectivity

The test case requires option Second RF path (B20x), a second option Baseband Main Module (13), a second option Baseband Generator (B10/B11) and a second option Digital Standard 3GPP FDD (K42) in addition to the standard configuration. It is performed using the standard test setup for two paths.

The signal generator outputs the reference measurement channel signal (= wanted signal) at output RF A(B) and the adjacent channel interfering signal at output RF B(A). After combining the two signals the sum signal is fed into the base station Rx port. The signal generator will start signal generation at the first BS frame trigger sent to input **Trigger 1**.

The measurement must be made at the three frequencies B, M and T.

The following table lists the settings on the base station:

Parameter	Value
Frequency	B, M and T
RMC	12.2 kbps
Scrambling code	Any

### Test Purpose and Test Settings - Test Case 7.4

The test case verifies that a BS receiver has the capability to demodulate a signal that is sent by the signal generator but superimposed by a heavy WCDMA signal in the adjacent channel.

The test is passed when the resulting BER (calculated internally by the BS) is below 0.001 at the test frequencies B, M, and T. Note TS 25.141 Annex C: General Rules for Statistical Testing, where test conditions in terms of test methods and test conditions are defined.

Quotation from TS 25.141:

*Adjacent channel selectivity (ACS) is a measure of the receiver ability to receive a wanted signal at its assigned channel frequency in the presence of an adjacent channel signal at a given frequency offset from the center frequency of the assigned channel. ACS is the ratio of the receiver filter attenuation on the assigned channel frequency to the receive filter attenuation on the adjacent channel(s).*



The interference signal is offset from the wanted signal by the frequency offset  $F_{uw}$ . The interference signal shall be a W-CDMA signal as specified in Annex I.

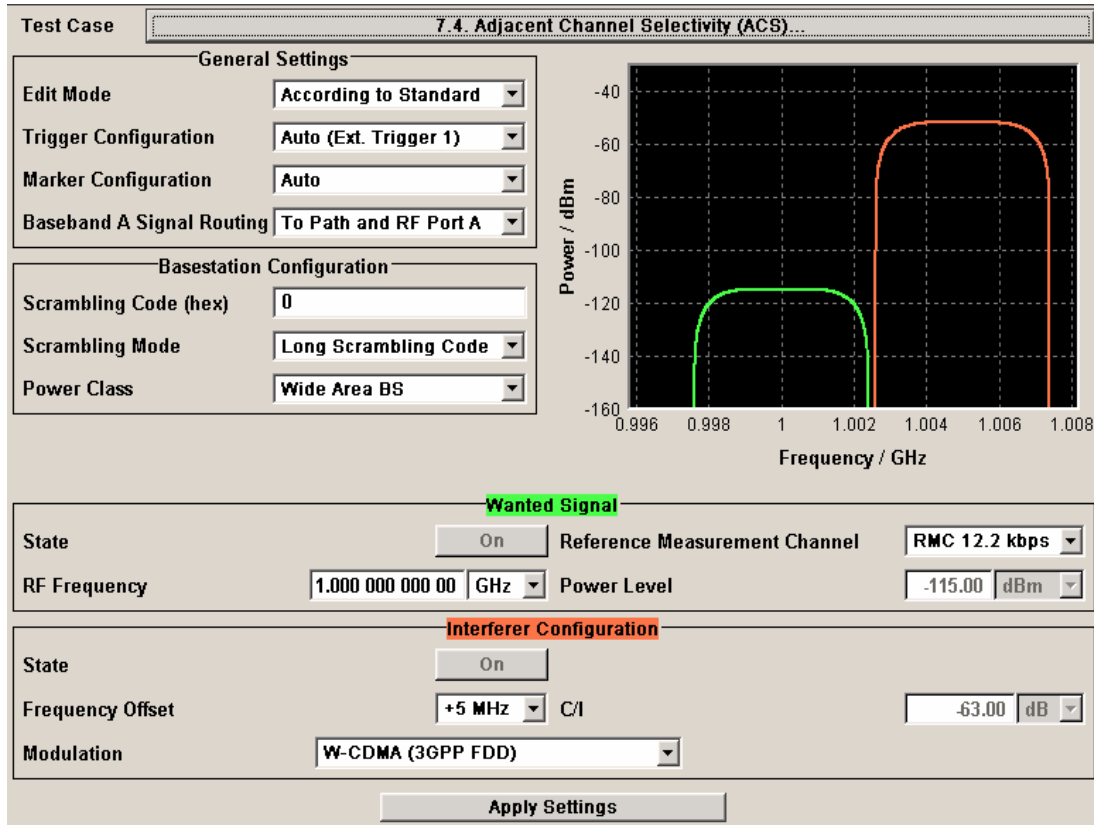

Besides the settings described for all receiver test, interferer configuration is possible in edit mode "User Definable". In edit mode 'According to Standard' the settings are preset.

**Interferer State - Test Case 7.4** Enables/disables the signal generation of the interfering uplink signal in the second path.

In edit mode 'According to Standard' the state is fixed to 'On'.

Remote-control command:

SOUR:BB:W3GP:TS25141:IFS:STAT ON | OFF

**Frequency Offset - Test Case 7.4** Enters the frequency offset of the interfering signal versus the wanted signal.

In edit mode 'According to Standard' the choice is limited to +/- 5MHz.

Remote-control command:

SOUR:BB:W3GP:TS25141:IFS:FOFF -5MHz

**C to I - Test Case 7.4**

Enters the ratio of wanted signal level to interfering signal level.

In edit mode '**According to Standard**' the value is fixed to - 63 dB:

Remote-control command:

SOUR:BB:W3GP:TS25141:IFS:CNR -30

**Interferer Modulation - Test Case 7.4**

Selects the type of modulation for the interfering uplink signal in the second path.

In edit mode '**According to Standard**' the modulation is fixed to '**W-CDMA (3GPP FDD)**'.

**W-CDMA (3GPP FDD)**

A 3GPP FDD uplink signal with the following characteristic is generated for path B.

- DPCCH + DPDCH mode
- DPDCH with 240 ksps, 0 dB relative power, PRBS23 data source
- DPCCH with -5.46 dB relative power and slot format 2
- Same scrambling code as the wanted signal

(3GPP FDD menu)

Remote-control command:

SOUR:BB:W3GP:TS25141:IFS:TYPE WCDM

**QPSK (3.84 MHz, Root Cosine 0.22)**

A QPSK signal (3.84 MHz bandwidth, root cosine filter 0.22, PRBS9 data source) is generated for path B (**Custom Dig Mod** menu).

Remote-control command:

SOUR:BB:W3GP:TS25141:IFS:TYPE QPSK

## Test Case 7.5 - Blocking Characteristics

The test case requires option Second RF path (B20x), a second option Baseband Main Module (13), a second option Baseband Generator (B10/B11) and a second option Digital Standard 3GPP FDD (K42) in addition to the standard configuration. It is performed using the standard test setup for two paths.

The signal generator provides the reference measurement channel signal (= wanted signal) at output RF A and the interfering signal with a selectable frequency offset at output RF B. After combining the two signals the sum signal is fed into the base station Rx port. The signal generator will start signal generation at the first BS frame trigger sent to input **Trigger 1**.

The measurement must be made at the frequency M.

The following table lists the settings on the base station:

Parameter	Value
Frequency	M
RMC	12.2 kbps
Scrambling code	Any

**Note:**

*In comparison with test case 7.4 this test case requires very large offset frequencies for the interfering signal. Therefore, a second RF output is always required.  
Due to the maximum frequency range of 6 GHz (option B106), the test case can not be performed at all frequency offsets required by the standard (1 MHz to 12.75 GHz).*

**Test Purpose and Test Settings - Test Case 7.5**

The test case verifies that a BS receiver has the capability to demodulate a signal that is sent by the signal generator but superimposed by a heavy interfering signal in the not adjacent channel.

The test is passed when the resulting BER (calculated internally by the BS) is below 0.001 at the test frequency M. Note TS 25.141 Annex C: General Rules for Statistical Testing, where test conditions in terms of test methods and test conditions are defined.

Quotation from TS 25.141:

*The blocking characteristics is a measure of the receiver ability to receive a wanted signal at its assigned channel frequency in the presence of an unwanted interferer on frequencies other than those of the adjacent channels. The blocking performance requirement applies as specified in tables 7.4A to 7.4J.*

*The requirements shall apply to the indicated base station class, depending on which frequency band is used. The requirements in Tables 7.4D to 7.4J may be applied for the protection of FDD BS receivers when GSM900, DCS1800, PCS1900, GSM850 and/or FDD BS operating in Bands I to VI are co-located with a UTRA FDD BS.*

Test Case **7.5. Blocking Characteristics...**

**General Settings**

Edit Mode: **According to Standard**

Trigger Configuration: **Auto (Ext. Trigger 1)**

Marker Configuration: **Auto**

Baseband A Signal Routing: **To Path and RF Port A**

**Basestation Configuration**

Scrambling Code (hex): **0**

Scrambling Mode: **Long Scrambling Code**

Power Class: **Wide Area BS**

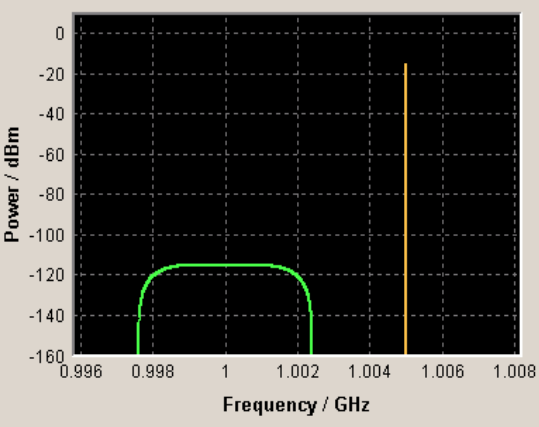

**Wanted Signal**

State: **On** Blocking Scenario: **Wideband Blocking**

Reference Measurement Channel: **RMC 12.2 kbps** Operating Band: **I: (1920 - 1980 MHz)**

RF Frequency: **1.000 000 000 GHz** Power Level: **-115.0 dBm**

**Interferer Configuration**

State: **On**

Frequency Offset: **5.000 000 00 MHz** Power Level: **-15.00 dBm**

Modulation: **CW Carrier**

**Apply Settings**

Besides the settings described for all receiver test, the following settings are possible in edit mode "User Definable". In edit mode 'According to Standard' most settings are preset.

Additional settings in the **Wanted Signal** section:

#### Blocking Scenario - Test Case 7.5

Selects the type of blocking scenario in edit mode 'According to Standard'.

The type of blocking scenario presets the selected **Interferer Modulation** and the **Power Level**.

**Wideband Blocking**

The interferer signal for wide band blocking depends on the set **Operating Band** and **RF Frequency**:

- As long as the interferer **RF frequency** lies within or close to the selected **Operating Band**, a **3GPP FDD** uplink signal with a defined power level (depending on the selected Power Class and RMC) is generated for path B.
- When the interferer **RF Frequency** lies outside the selected **Operating Band**, a **CW carrier** interfering signal with a defined power level (depending on the selected Power Class and RMC) is generated for path B.

Remote-control command:

```
SOUR:BB:W3GP:TS25141:WSIG:BTYP WIDE
```

**Collocated BS Blocking**

A CW carrier interfering signal with a defined power level (depending on the selected Power Class and RMC) is generated for path B (**RF menu**)

Remote-control command:

```
SOUR:BB:W3GP:TS25141:WSIG:BTYP COL
```

**Narrowband Blocking**

A GMSK (270.833 kHz) interfering signal with a defined power level (depending on the selected Power Class and RMC) is generated for path B (**Custom Dig Mod menu**).

Remote-control command:

```
SOUR:BB:W3GP:TS25141:WSIG:BTYP NARR
```

**Operating Band - Test Case 7.5** (Wideband Blocking only) Selects the operating band of the base station for **Wideband Blocking**. The operating band is required for the calculation of power levels and interferer modulation.

- Operating band I: (1920 – 1980 MHz)
- Operating band II: (1850 – 1910 MHz)
- Operating band III: (1710 – 1785 MHz)
- Operating band IV: (1710 – 1755 MHz)
- Operating band V: (824 – 849 MHz)
- Operating band VI: (830 – 840 MHz)

Remote-control command:

```
SOUR:BB:W3GP:TS25141:WSIG:OBAN II
```

Settings in the **Interferer Signal** section:

**Interferer State - Test Case 7.5**

Enables/disables the signal generation of the interfering signal in the second path.

In edit mode '**According to Standard**' the state is fixed to '**On**'.

Remote-control command:

SOUR:BB:W3GP:TS25141:IFS:STAT OFF

**Frequency Offset - Test Case 7.5**

Enters the frequency offset of the interfering signal versus the wanted signal.

Remote-control command:

SOUR:BB:W3GP:TS25141:IFS:FOFF -5 MHz

**Power Level - Test Case 7.5**

Enters the level of the interfering signal.

In edit mode '**According to Standard**' the value is fixed to a value determined by the selected **Blocking Scenario**, the **RF frequency** and **Frequency Offset** and the base station **Power Class**.

For blocking scenario **Colocated BS Blocking** several power settings are permitted by the standard. The following table show the blocking requirements for Medium Range and Local Area BS when co-located with BS in other bands.

Remote-control command:

SOUR:BB:W3GP:TS25141:IFS:POW -15

Blocking performance requirement for Medium Range BS when co-located with BS in other bands.

Co-located BS type	Center Frequency of Interfering Signal	Interfering Signal mean power
Micro GSM850	869 – 894 MHz	-3 dBm
MR UTRA-FDD Band V	869 – 894 MHz	+8 dBm
MR UTRA-FDD Band III	1805 – 1880 MHz	+8 dBm
Micro DCS1800	1805 – 1880 MHz	+5 dBm
Micro PCS1900	1930 – 1990 MHz	+5 dBm
MR UTRA-FDD Band II	1930 – 1990 MHz	+8 dBm

Blocking performance requirement for Local Area BS when co-located with BS in other bands.

Co-located BS type	Center Frequency of Interfering Signal	Interfering Signal mean power
LA UTRA-FDD Band V	869 – 894 MHz	-6 dBm
Pico GSM850	869 – 894 MHz	-7 dBm
LA UTRA-FDD Band III	1805 – 1880 MHz	-6 dBm
Pico DCS1800	1805 – 1880 MHz	-4 dBm
LA UTRA-FDD Band II	1930 – 1990 MHz	-6 dBm
Pico PCS1900	1930 – 1990 MHz	-4 dBm

**Interferer Modulation - Test Case 7.5**

Selects the type of modulation for the adjacent channel interfering signal at output RF B.

In edit mode '**According to Standard**' the modulation is fixed to a value determined by the selected **Blocking Scenario**.

**W-CDMA (3GPP FDD)**

A 3GPP FDD uplink signal with the following characteristic is generated for path B.

- DPCCH + DPDCH mode
- DPDCH with 240 ksps, 0 dB relative power, PRBS23 data source
- DPCCH with -5.46 dB relative power and slot format 2
- Same scrambling code as the wanted signal

**(3GPP FDD menu)**

Remote-control command:

SOUR:BB:W3GP:TS25141:IFS:TYPE WCDM

**QPSK (3.84 MHz, Root Cosine 0.22)**

A QPSK signal (3.84 MHz bandwidth, root cosine filter 0.22, PRBS9 data source) is generated for path B (**Custom Dig Mod** menu).

Remote-control command:

SOUR:BB:W3GP:TS25141:IFS:TYPE QPSK

**CW Carrier**

A QPSK signal (3.84 MHz bandwidth, root cosine filter 0.22, PRBS9 data source) is generated for path B (**Custom Dig Mod** menu).

Remote-control command:

SOUR:BB:W3GP:TS25141:IFS:TYPE CW

**GMSK (270.833 kHz)**

A GMSK signal (270.833 kHz bandwidth, PRBS9 data source) is generated for path B (**Custom Dig Mod** menu).

Remote-control command:

SOUR:BB:W3GP:TS25141:IFS:TYPE GMSK

## Test Case 7.6 - Intermodulation Characteristics

The test case requires option Second RF path (B20x), a second option Baseband Main Module (13), a second option Baseband Generator (B10/B11), a second option Digital Standard 3GPP FDD (K42) and option AWGN (K62) in addition to the standard configuration. It is performed using the standard test setup for two paths.

The signal generator outputs the reference measurement channel signal (= wanted signal) at output RF A and both interfering signals (CW interferer and the WCDMA or GMSK modulated interferer) at output RF B. After combining the signals the sum signal is fed into the base station Rx port. The signal generator will start signal generation at the first BS frame trigger sent to input **Trigger 1**.

The measurement must be made at frequency M.

---

### Note:

*In order to generate both interfering signals with the desired frequency offset, a frequency offset is introduced for baseband B. This baseband frequency offset has to be added to the RF frequency B.*

---

The following table lists the settings on the base station:

Parameter	Value
Frequency	M
RMC	12.2 kbps
Scrambling code	Any

### Test Purpose and Test Settings - Test Case 7.6

The test case verifies that a BS receiver has the capability to demodulate a signal that is sent by the signal generator but superimposed by two heavy interfering signals in the adjacent channels, where the receiver intermodulation products disturb the wanted signal.

The test is passed when the resulting BER (calculated internally by the BS) is below 0.001 at the test frequency M. Note TS 25.141 Annex C: General Rules for Statistical Testing, where test conditions in terms of test methods and test conditions are defined.

Quotation from TS 25.141:

*Third and higher order mixing of the two interfering RF signals can produce an interfering signal in the band of the desired channel. Intermodulation response rejection is a measure of the capability of the receiver to receive a wanted signal on its assigned channel frequency in the presence of two or more interfering signals which have a specific frequency relationship to the wanted signal.*



Test Case: 7.6. Intermodulation Characteristics...

**General Settings**

Edit Mode: According to Standard  
 Trigger Configuration: Auto (Ext. Trigger 1)  
 Marker Configuration: Auto  
 Baseband A Signal Routing: To Path and RF Port A

**Basestation Configuration**

Scrambling Code (hex): 0  
 Scrambling Mode: Long Scrambling Code  
 Power Class: Wide Area BS

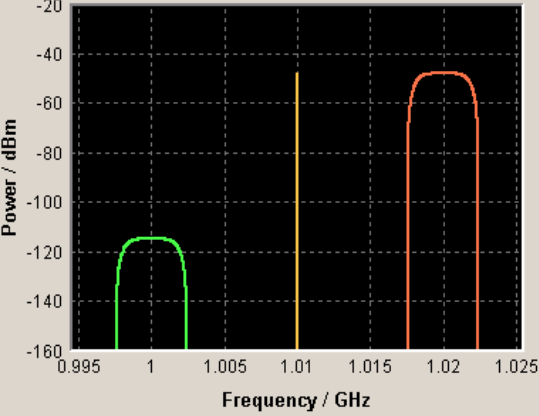

**Wanted Signal**

State: On  
 Reference Measurement Channel: RMC 12.2 kbps  
 RF Frequency: 1.000 000 00 GHz  
 Power Level: -115.0 dBm

**Interferer Configuration**

Bandwidth Type: Wideband

**Interferer 1: CW Carrier**

State: On  
 Frequency Offset: 10.000 000 00 MHz  
 Power Level: -48.00 dBm

**Interferer 2: Modulated Signal**

State: On  
 Modulation: W-CDMA (3GPP FDD)  
 Frequency Offset: 20.000 000 00 MHz  
 Power Level: -48.00 dBm

Apply Settings

Besides the settings described for all receiver tests, interferer 1 and 2 configuration is possible in edit mode "User Definable". In edit mode 'According to Standard' most of the settings are preset.

**Interferer Bandwidth Type - Test Case 7.6** - Selects the interferer scenario.

### Wideband

A 3GPP FDD uplink interfering signal with the following characteristic is generated for path B.

- DPCCH + DPDCH mode
- DPDCH with 240 kbps, 0 dB relative power, PRBS23 data source
- DPCCH with -5.46 dB relative power and slot format 2
- Same scrambling code as the wanted signal

### (3GPP FDD menu)

The 3GPP FDD uplink interfering signal is superimposed by a CW interfering signal with a frequency of 10 MHz and a level of -48 dBm (**AWGN** menu).

Remote-control command:

```
SOUR:BB:W3GP:TS25141:IFS:BWID WIDE
```

**Narrowband**

A GMSK interfering signal (270.833 kHz bandwidth, PRBS9 data source) is generated for path B (**Custom Dig Mod** menu).

The GMSK interfering signal is superimposed by a CW interfering signal with a frequency of 3.5 MHz and a level of -47 dBm (**AWGN** menu).

Remote-control command:

```
SOUR:BB:W3GP:TS25141:IFS:BWID NARR
```

**Interferer 1 and 2 State -  
Test Case 7.6**

Enables/disables the signal generation of the CW and modulation interfering signal in the second path.

In edit mode '**According to Standard**' both states are fixed to '**On**'.

Remote-control command:

```
SOUR:BB:W3GP:TS25141:IFS:CW:STAT ON  
SOUR:BB:W3GP:TS25141:IFS:MOD:STAT ON
```

**Interferer 1 and 2  
Frequency Offset - Test  
Case 7.6**

Enters the frequency offset of the interfering signals versus the wanted signal.

In edit mode '**According to Standard**' the value is fixed to a value determined by the selected **Interferer Bandwidth**.

Remote-control command:

```
SOUR:BB:W3GP:TS25141:IFS:CW:FOFF -3.5MHz  
SOUR:BB:W3GP:TS25141:IFS:MOD:FOFF -5.9MHz
```

**Interferer 1 and 2 Power  
Level - Test Case 7.6**

Enters the level of the interfering signals.

In edit mode '**According to Standard**' the value is fixed to a value determined by the selected **Interferer Bandwidth Type**.

Remote-control command:

```
SOUR:BB:W3GP:TS25141:IFS:CW:POW -47dBm  
SOUR:BB:W3GP:TS25141:IFS:MOD:POW -48dBm
```

**Interferer 2 Modulation -  
Test Case 7.6**

Selects the type of modulation for the interfering modulation signal in the second path.

In edit mode '**According to Standard**' the value is fixed to a value determined by the selected **Interferer Bandwidth**.

<b>W-CDMA (3GPP FDD)</b>	<p>A 3GPP FDD uplink signal with the following characteristic is generated for path B.</p> <ul style="list-style-type: none"> <li>- DPCCH + DPDCH mode</li> <li>- DPDCH with 240 ksps, 0 dB relative power, PRBS23 data source</li> <li>- DPCCH with -5.46 dB relative power and slot format 2</li> <li>- Same scrambling code as the wanted signal (<b>3GPP FDD</b> menu)</li> </ul> <p>Remote-control command: SOUR:BB:W3GP:TS25141:IFS:MOD:TYPE WCDM</p>
<b>GMSK (270833 kHz)</b>	<p>A GMSK signal (270.833 kHz bandwidth, PRBS9 data source) is generated for path B (<b>Custom Dig Mod</b> menu).</p> <p>Remote-control command: SOUR:BB:W3GP:TS25141:IFS:MOD:TYPE GMSK</p>
<b>QPSK (3.84 MHz, Root Cosine 0.22)</b>	<p>A QPSK signal (3.84 MHz bandwidth, root cosine filter 0.22, PRBS9 data source) is generated for path B (<b>Custom Dig Mod</b> menu).</p> <p>Remote-control command: SOUR:BB:W3GP:TS25141:IFS:MOD:TYPE QPSK</p>

## Test Case 7.8 - Verification of Internal BER

The test case requires the basic configuration and is performed using the standard test setup for one path.

The signal generator outputs a corrupted reference measurement channel signal (= wanted signal) at output RF A. The signal is fed into the base station Rx port.

The signal generator will start signal generation at the first BS frame trigger sent to input **Trigger 1**.

The measurement must be made at the three frequencies B, M and T.

The following table lists the settings on the base station:

Parameter	Value
Frequency	B, M and T
RMC	12.2 kbps
Scrambling code	Any

## Test Purpose and Test Settings - Test Case 7.8

The test case verifies that a BS receiver has the capability to calculate the BER of a signal where erroneous bits are inserted in the data stream by the signal generator.

The test is passed when the calculated BER is within  $\pm 10\%$  of the BER simulated by the signal generator the test frequencies B, M and T. Note TS 25.141 Annex C: General Rules for Statistical Testing, where test conditions in terms of test methods and test conditions are defined.

Quotation from TS 25.141:

*Base Station System with internal BER calculation can synchronize its receiver to known pseudo-random data sequence and calculates bit error ratio from the received data. This test is performed only if Base Station System has this kind of feature. This test is performed by feeding measurement signal with known BER to the input of the receiver. Locations of the erroneous bits shall be randomly distributed within a frame. Erroneous bits shall be inserted to the data bit stream as shown in (the following) figure 7.1.*

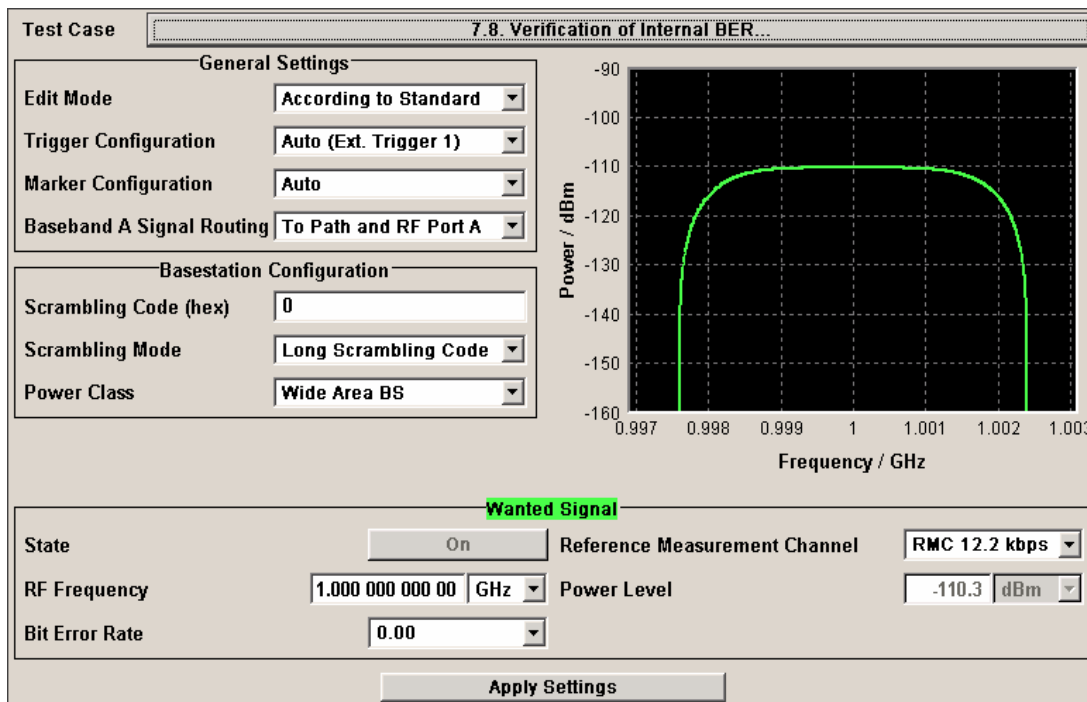
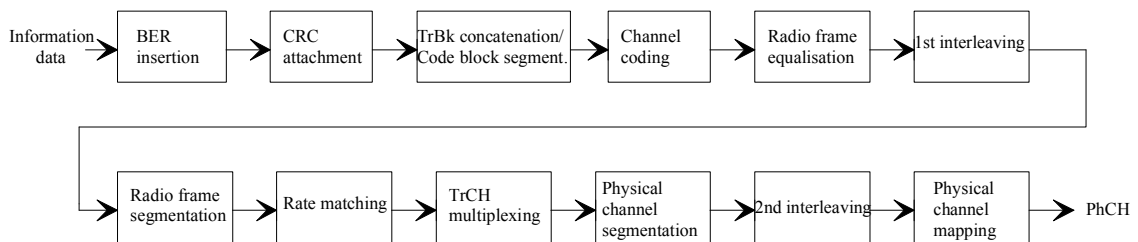

Besides the settings described for all receiver test, Bit Error Rate and Block Error Rate selection is possible in edit mode "User Definable". In edit mode 'According to Standard' only the Bit Error Rate setting is possible.

**Bit Error Rate - Test Case 7.8**

Sets the bit error rate. In edit mode '**According to Standard**' only values 0.00 (no bit errors are inserted) and 0.01 (1 percent bit errors are inserted) are available.

Remote-control command:

```
SOUR:BB:W3GP:TS25141:WSIG:DPDC:DERR:BIT:RATE 0.01
```

**Block Error Rate - Test Case 7.8**

Sets the block error rate in edit mode "**User Definable**".

Remote-control command:

```
SOUR:BB:W3GP:TS25141:WSIG:DPDC:DERR:BLOC:RATE 0.001
```

## Performance Requirements - Receiver Tests - 3GPP FDD

### Test Case 8.2.1 - Demodulation of DCH in Static Propagation Conditions

For **non-diversity measurements**, the test case requires Additional White Gaussian Noise (AWGN) (K62) in addition to the basic configuration.

The measurement is performed using the standard test setup for one path.

The signal generator outputs a reference measurement channel signal (= wanted signal) that is superimposed by a AWGN signal at output RF A. The signal is fed into the base station Rx port.

The signal generator will start signal generation at the first BS frame trigger sent to input **Trigger 1**.

The measurement must be made at the three frequencies B, M and T. The RMC data rates are 12.2 kbps, 64 kbps, 144 kbps and 384 kbps.

For **diversity measurements**, the test case requires option Second RF path (B20x), a second option Baseband Main Module (13), a second option Baseband Generator (B10/B11) and two options Additional White Gaussian Noise (AWGN) (K62) in addition to the standard configuration. It is performed using the standard test setup for diversity measurement.

The signal generator outputs the reference measurement channel signal (= wanted signal) at output RF A and output RF B. The wanted signal is superimposed by a AWGN signal. The signals are fed into the base station Rx ports.

The signal generator will start signal generation at the first BS frame trigger sent to input **Trigger 1**.

The measurement must be made at the three frequencies B, M and T. The RMC data rates are 12.2 kbps, 64 kbps, 144 kbps and 384 kbps.

The following table lists the settings on the base station:

Parameter	Value(s)
Frequency	B, M and T
RMC	12.2 kbps, 64 kbps, 144 kbps, 384 kbps
Scrambling code	Any

**Test Purpose and Test Settings - Test Case 8.2.1**

The test case shall verify that a BS receiver has the capability to demodulate a signal that is sent by the signal generator and is superimposed by a heavy AWGN signal.

The test is passed when the resulting BLER (calculated internally by the BS) does not exceed the required BLER settings. Note TS 25.141 Annex C: General Rules for Statistical Testing, where test conditions in terms of test methods and test conditions are defined.

Quotation from TS 25.141:

*The performance requirement of DCH in static propagation conditions is determined by the maximum Block Error Ratio (BLER) allowed when the receiver input signal is at a specified Eb/NO limit. The BLER is calculated for each of the measurement channels supported by the base station.*

The screenshot displays the configuration for Test Case 8.2.1, "Demodulation of DCH in Static Propagation Conditions...".

- General Settings:** Edit Mode (According to Standard), Trigger Configuration (Auto (Ext. Trigger 1)), Marker Configuration (Auto), Diversity (Off), Baseband A Signal Routing (To Path and RF Port A).
- Basestation Configuration:** Scrambling Code (hex) (0), Scrambling Mode (Long Scrambling Code), Power Class (Wide Area BS).
- Wanted Signal:** State (On), Reference Measurement Channel (RMC 12.2 kbps), RF Frequency (1.000 000 000 GHz), Power Level (-77.80 dBm).
- AWGN Configuration:** State (On), Required BLER (< 0.01), Power Level (within 3.84 MHz BW) (-84.00 dBm), Eb/NO (8.7 dB).
- Fading Configuration:** State (Off).

An "Apply Settings" button is located at the bottom of the configuration area.

Besides the settings described for all receiver test, AWGN Configuration is possible in edit mode "User Definable". In edit mode 'According to Standard' only the Required BLER setting is possible.

**AWGN State - Test Case 8.x**

Enables/disables the generation of the AWGN signal.

In edit mode '**According to Standard**' the state is fixed to '**On**'.

Remote-control command:

SOUR:BB:W3GP:TS25141:AWGN:STAT ON

**Required BLER - Test Case 8.x**

Sets the required Block Error Rate in edit mode '**According to Standard**'.

Remote-control command:

SOUR:BB:W3GP:TS25141:AWGN:RBL:RATE B001

**Power Level - Test Case 8.x** (within 3.84 MHz BW) Sets the AWGN level in edit mode '**User Definable**'.

In edit mode '**According to Standard**' the AWGN level is determined by the selected **Power Class**.

- **-84 dBm for Wide Area BS**
- **-74 dBm for Medium Range BS**
- **-70 dBm for Local Area BS**

Remote-control command:

SOUR:BB:W3GP:TS25141:AWGN:POW:NOIS -45.0dBm

**Eb to N0 - Test Case 8.x**

Sets the ratio of bit energy to noise power density.

In edit mode '**According to Standard**' the value depends on the  $E_b/N_0$  test requirements (see following table).

Remote-control command:

SOUR:BB:W3GP:TS25141:AWGN:ENR 8.7dB

$E_b/N_0$  test requirements in AWGN channel

Measurement channel	Received for BS with Rx diversity	$E_b/N_0$	Received for BS without Rx diversity	$E_b/N_0$	Required BLER
12.2 kbps	n.a. (5.5 dB)		n.a. (8.7 dB)		$< 10^{-1}$
	5.5 dB		8.7 dB		$< 10^{-2}$
64 kbps	1.9 dB		5.1 dB		$< 10^{-1}$
	2.1 dB		5.2 dB		$< 10^{-2}$
144 kbps	1.2 dB		4.2 dB		$< 10^{-1}$
	1.3 dB		4.4 dB		$< 10^{-2}$
384 kbps	1.3 dB		4.4 dB		$< 10^{-1}$
	1.4 dB		4.5 dB		$< 10^{-2}$

## Test Case 8.6 - Verification of Internal BLER

For **non-diversity measurements**, the test case requires the basic configuration and is performed using the standard test setup for one path.

The signal generator outputs a corrupted reference measurement channel signal (= wanted signal) at output RF A. The signal is fed into the base station Rx port.

The signal generator will start signal generation at the first BS frame trigger sent to input **Trigger 1**.

The measurement must be made at the three frequencies B, M and T. The RMC data rates are 12.2 kbps, 64 kbps, 144 kbps and 384 kbps.

For **diversity measurements**, the test case requires option Second RF path (B20x) and a second option Baseband Main Module (B13) in addition to the basic configuration.

It is performed using the standard test setup for diversity measurement.

The signal generator outputs the corrupted reference measurement channel signal (= wanted signal) at output RF A and output RF B. The signals are fed into the base station Rx ports.

The signal generator will start signal generation at the first BS frame trigger sent to input **Trigger 1**.

The measurement must be made at the three frequencies B, M and T. The RMC data rates are 12.2 kbps, 64 kbps, 144 kbps and 384 kbps.

The following table lists the settings on the base station:

Parameter	Value
Frequency	B, M and T
RMC	12.2 kbps, 64 kbps, 144 kbps, 384 kbps
Scrambling code	Any

### Test Purpose and Test Settings - Test Case 8.6

The test case verifies that a BS receiver has the capability to calculate the BLER of a signal where erroneous blocks are inserted in the data stream by the signal generator.

The test is passed when the calculated BLER is within  $\pm 10\%$  of the BLER simulated by the signal generator the test frequencies B, M and T. Note TS 25.141 Annex C: General Rules for Statistical Testing, where test conditions in terms of test methods and test conditions are defined.

Quotation from TS 25.141:

*Base Station System with internal BLER calculates block error rate from the CRC blocks of the received. This test is performed only if Base Station System has this kind of feature. All data rates which are used in clause 8 Performance requirement testing shall be used in verification testing. This test is performed by feeding measurement signal with known BLER to the input of the receiver. Locations of the erroneous blocks shall be randomly distributed within a frame. Erroneous blocks shall be inserted into the UL signal as shown in (the following) figure 8.1.*



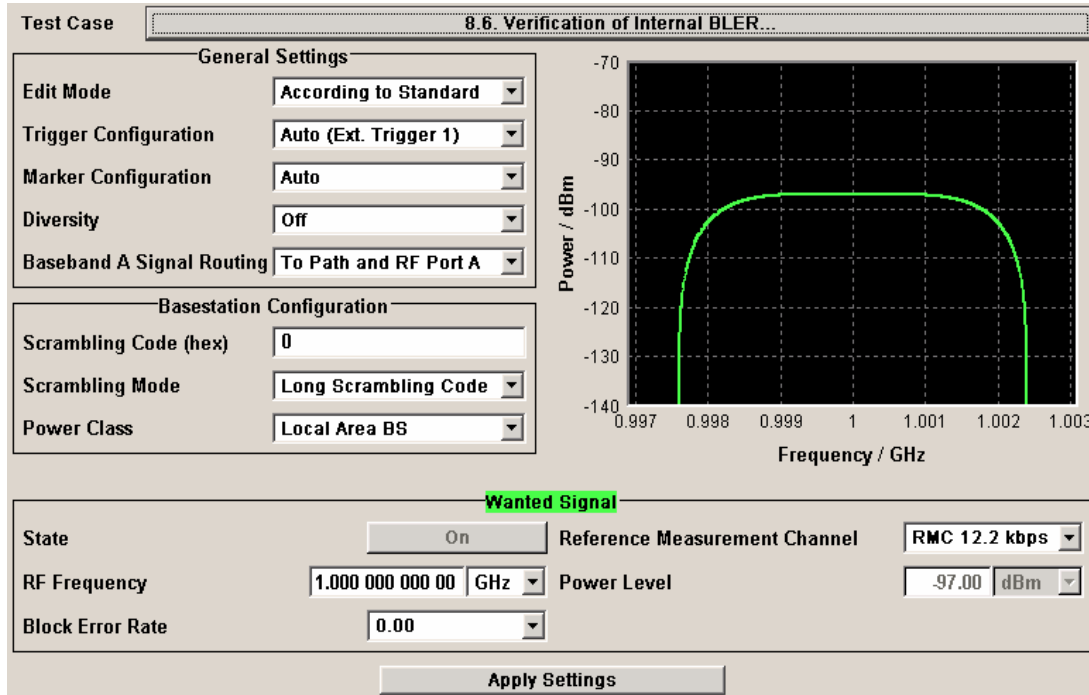
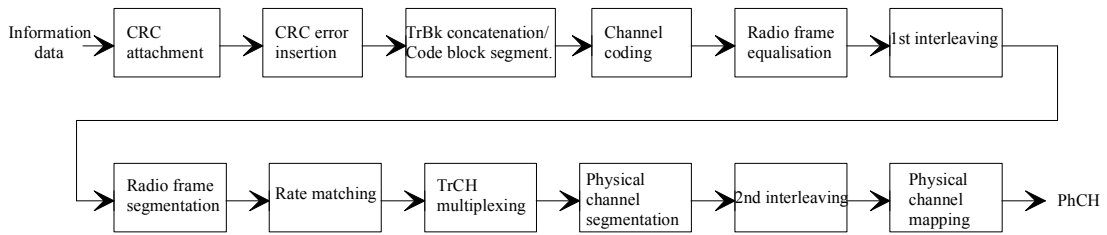

Besides the settings described for all receiver test, Bit Error Rate and Block Error Rate selection is possible in edit mode "User Definable". In edit mode 'According to Standard' only the Block Error Rate setting is possible.

UL signal levels for different data rates

Data rate	Signal level for Wide Area BS	Signal level for Medium Range BS	Signal level for Local Area BS	Unit
12,2 kbps	-111	-101	-97	dBm/3.84 MHz
64 kbps	-107	-97	-93	dBm/3.84 MHz
144 kbps	-104	-94	-90	dBm/3.84 MHz
384 kbps	-100	-90	-86	dBm/3.84 MHz

**Block Error Rate - Test Case 8.6**

Sets the block error rate. In edit mode 'According to Standard' only values 0.00 (no block errors are inserted) and 0.01 (1 percent block errors are inserted) are available.

Remote-control command:

SOUR:BB:W3GP:TS25141:WSIG:DPDC:DERR:BLOC:RATE 0.01

**Bit Error Rate - Test Case 8.6**

Sets the bit error rate in edit mode "User Definable".

Remote-control command:

SOUR:BB:W3GP:TS25141:WSIG:DPDC:DERR:BIT:RATE 0.001

## Test Case 8.8.1 - RACH Preamble Detection in Static Propagation Conditions

For **non-diversity measurements**, the test case requires option K62 - Additional White Gaussian Noise (AWGN) in addition to the basic configuration.

The measurement is performed using the standard test setup for one path.

The signal generator outputs a continuous sequence of preambles (wanted signal) that is superimposed by a AWGN signal at output RF A(B). The signal is fed into the base station Rx port.

The signal generator will start signal generation at the first BS frame trigger sent to input **Trigger 1**.

The measurement must be made at the three frequencies B, M and T.

For **diversity measurements**, the test case requires option Second RF path (B20x), a second option Baseband Main Module (13), and two options Additional White Gaussian Noise (AWGN) (K62) in addition to the standard configuration. It is performed using the standard test setup for diversity measurement.

The signal generator outputs a continuous sequence of preambles (wanted signal) that is superimposed by a AWGN signal at output RF A and output RF B. The signals are fed into the base station Rx ports.

The signal generator will start signal generation at the first BS frame trigger sent to input **Trigger 1**.

The measurement must be made at the three frequencies B, M and T.

The following table lists the settings on the base station:

Parameter	Value(s)
Frequency	B, M and T
RMC	RACH
Scrambling code	Any

### Test Purpose and Test Settings - Test Case 8.8.1

The test case verifies that a BS receiver has the capability to detect the RACH preamble that is sent by the signal generator and is superimposed by a heavy AWGN signal.

The test is passed when internally calculated Pd is equal or above the required Pd settings at the test frequencies B, M and T. Note TS 25.141 Annex C: General Rules for Statistical Testing, where test conditions in terms of test methods and test conditions are defined.

Quotation from TS 25.141:

The performance requirement of RACH for preamble detection in static propagation conditions is determined by the two parameters probability of false detection of the preamble ( $P_{fa}$ ) and the probability of detection of preamble ( $P_d$ ). The performance is measured by the required  $E_c/N_0$  at probability of detection,  $P_d$  of 0.99 and 0.999.  $P_{fa}$  is defined as a conditional probability of erroneous detection of the preamble when input is only noise (+interference).  $P_d$  is defined as conditional probability of detection of the preamble when the signal is present.  $P_{fa}$  shall be  $10^{-3}$  or less. Only one signature is used and it is known by the receiver.

**Note:**

The Probability of false detection of the preamble ( $P_{fa}$ ) test is not supported.

The screenshot displays the configuration interface for a RACH preamble detection test. The test case is '8.8.1. RACH Preamble Detection in Static Propagation Conditions...'. The 'General Settings' section includes 'Edit Mode' (According to Standard), 'Trigger Configuration' (Auto (Ext. Trigger 1)), 'Marker Configuration' (Auto), 'Diversity' (Off), and 'Baseband A Signal Routing' (To Path and RF Port A). The 'Basestation Configuration' section includes 'Scrambling Code (hex)' (0), 'Scrambling Mode' (Long Scrambling Code), and 'Power Class' (Wide Area BS). The 'Wanted Signal' section is set to 'On' with an RF Frequency of 1.000 000 000 GHz and a Power Level of -101.2 dBm. The 'AWGN Configuration' section is set to 'On' with a Required  $P_d$  of  $\geq 0.99$ , a Power Level (within 3.84 MHz BW) of -84.00 dBm, and an  $E_c/N_0$  of -17.20 dB. The 'Fading Configuration' section is set to 'Off'. An 'Apply Settings' button is located at the bottom. A graph on the right shows Power / dBm vs Frequency / GHz, with a signal trace centered at 1.0 GHz.

Besides the settings described for all receiver test, AWGN is possible in edit mode "User Definable". In edit mode 'According to Standard' only the Required  $P_d$  setting is possible.

**AWGN State - Test Case 8.x**

Enables/disables the generation of the AWGN signal.

In edit mode 'According to Standard' the state is fixed to 'On'.

Remote-control command:

SOUR:BB:W3GP:TS25141:AWGN:STAT ON | OFF

**Required Pd - Test Case 8.x**

Sets the Required Probability of Detection of Preamble (Required Pd) in edit mode '**According to Standard**':

- **>= 0.99**
- **>= 0.999**

This figure determines the ratio  $E_c/N_0$  according to the following table of  $E_c/N_0$  test requirements.

Remote-control command:

SOUR:BB:W3GP:TS25141:AWGN:RPD:RATE PD099

Preamble detection test requirements in AWGN channel

	$E_c/N_0$ for required Pd $\geq 0.99$	$E_c/N_0$ for required Pd $\geq 0.999$
<b>BS with Rx Diversity</b>	-20.1 dB	-19.7 dB
<b>BS without Rx Diversity</b>	-17.2 dB	-16.4 dB

**Power Level - Test Case 8.x**

(within 3.84 MHz BW) Sets the AWGN level in edit mode '**User Definable**'.

In edit mode '**According to Standard**' the AWGN level is determined by the selected **Power Class**.

- **-84 dBm for Wide Area BS**
- **-74 dBm for Medium Range BS**
- **-70 dBm for Local Area BS**

Remote-control command:

SOUR:BB:W3GP:TS25141:AWGN:POW:NOIS -45.0

**Eb to N0 - Test Case 8.x**

Sets the ratio of bit energy to noise power density.

In edit mode '**According to Standard**' the value depends on the selected **Required Pd**.

Remote-control command:

SOUR:BB:W3GP:TS25141:AWGN:ENR 8.7dB

## Test Case 8.8.3 - RACH Demodulation of Message Part in Static Propagation Conditions

For **non-diversity measurements**, the test case requires option K62 - Additional White Gaussian Noise (AWGN) in addition to the basic configuration.

The measurement is performed using the standard test setup for one path.

The signal generator outputs a RACH message signal (= wanted signal) that is superimposed by a AWGN signal at output RF A(B). The signal is fed into the base station Rx port.

The signal generator will start signal generation at the first BS frame trigger sent to input **Trigger 1**.

The measurement must be made at the three frequencies B, M and T. The Transport Block Sizes are 168 bits and 360 bits.

For **diversity measurements**, the test case requires option Second RF path (B20x), a second option Baseband Main Module (13), and two options Additional White Gaussian Noise (AWGN) (K62) in addition to the standard configuration. It is performed using the standard test setup for diversity measurement.

The signal generator outputs the RACH message signal (= wanted signal) that is superimposed by a AWGN signal at output RF A and output RF B. The signals are fed into the base station Rx ports.

The signal generator will start signal generation at the first BS frame trigger sent to input **Trigger 1**.

The measurement must be made at the three frequencies B, M and T. The Transport Block Sizes are 168 bits and 360 bits.

The following table lists the settings on the base station:

Parameter	Value(s)
Frequency	B, M and T
Transport Block Size	168 bits, 360 bits
RMC	RACH
Scrambling code	Any

### **Test Purpose and Test Settings - Test Case 8.8.3**

The test case shall verify that a BS receiver has the capability to demodulate the RACH message sent by the signal generator but superimposed by AWGN.

The test is passed when the resulting BLER (calculated internally by the BS) does not exceed the required BLER settings. Note TS 25.141 Annex C: General Rules for Statistical Testing, where test conditions in terms of test methods and test conditions are defined.

Quotation from TS 25.141:

*The performance requirement of RACH in static propagation conditions is determined by the maximum Block Error Ratio (BLER) allowed when the receiver input signal is at a specified Eb/N0 limit. The BLER is calculated for each of the measurement channels supported by the base station.*

*The preamble threshold factor is chosen to fulfil the requirements on Pfa and Pd in subclauses 8.8.1 and 8.8.2. Only one signature is used and it is known by the receiver.*

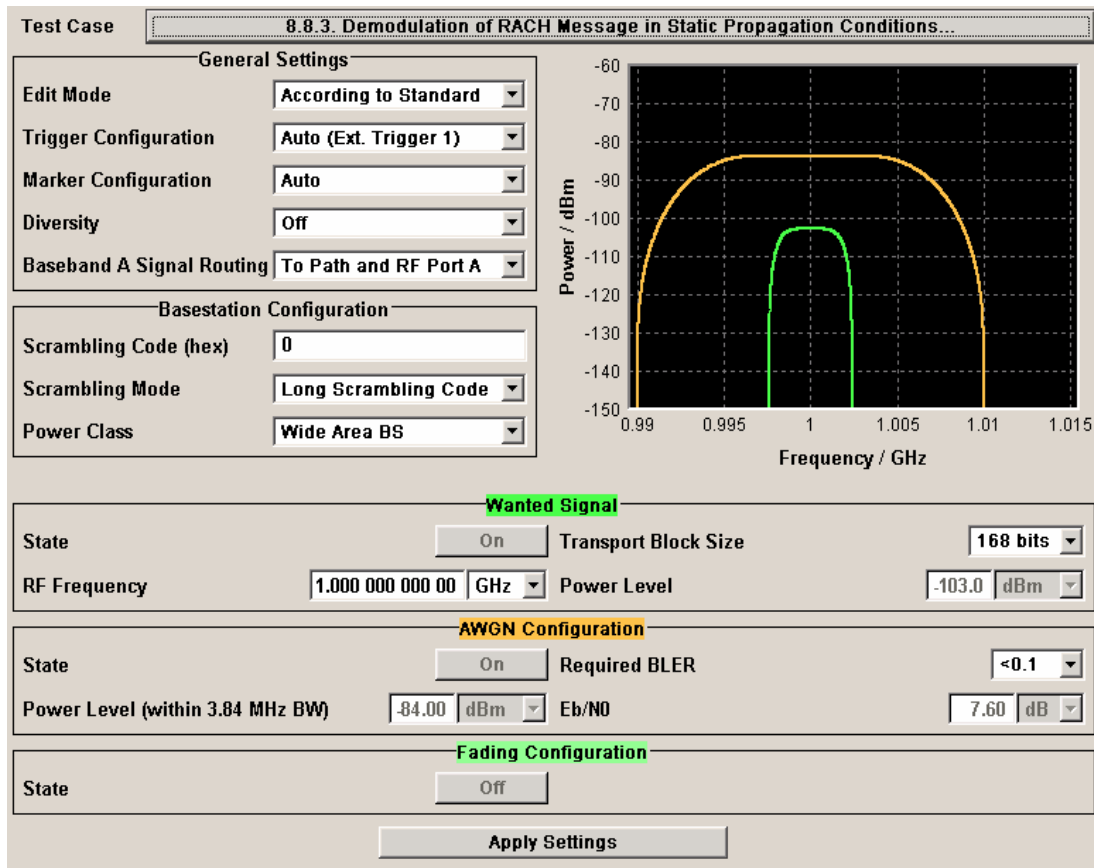

Besides the settings described for all receiver test, selection of **Transport Block Size** of the wanted signal and AWGN Configuration is possible in edit mode '**According to Standard**'.

**Transport Block Size (TB) - Test Case 8.9.3** - Sets the Transport Block Size:  
 - **168 bits**  
 - **360 bits**

Remote-control command:  
 SOUR:BB:W3GP:TS25141:WSIG:PRAC:CCOD:TYPE TB168

**AWGN State - Test Case 8.8.3**

Enables/disables the generation of the AWGN signal.  
 In edit mode '**According to Standard**' the state is fixed to '**On**'.

Remote-control command:  
 SOUR:BB:W3GP:TS25141:AWGN:STAT ON

**Required BLER - Test Case 8.x**

Sets the required Block Error Rate in edit mode 'According to Standard'.

- < 0.1
- < 0.01

This figure determines the ratio  $E_b/N_0$  according to the list of  $E_b/N_0$  test requirements (see following table).

Remote-control command:

```
SOUR:BB:W3GP:TS25141:AWGN:RBL:RATE B001
```

$E_b/N_0$  requirements in AWGN channel

Transport Block size TB and TTI in frames: 168 bits, TTI = 20 ms / 360 bits, TTI = 20 ms

	$E_b/N_0$ for required BLER < $10^{-1}$	$E_b/N_0$ for required BLER < $10^{-2}$	$E_b/N_0$ for required BLER < $10^{-1}$	$E_b/N_0$ for required BLER < $10^{-2}$
BS with Rx Diversity	4.5 dB	5.4 dB	4.3 dB	5.2 dB
BS without Rx Diversity	7.6 dB	8.5 dB	7.3 dB	8.2 dB

**Power Level - Test Case 8.8.3**

(within 3.84 MHz BW) Sets the AWGN level in edit mode 'User Definable'.

In edit mode 'According to Standard' the AWGN level is determined by the selected Power Class .

- -84 dBm for Wide Area BS
- -74 dBm for Medium Range BS
- -70 dBm for Local Area BS

Remote-control command:

```
SOUR:BB:W3GP:TS25141:AWGN:POW:NOIS -45.0 dBm
```

**Eb to N0- Test Case 8.8.3**

Sets the ratio of bit energy to noise power density.

In edit mode 'According to Standard' the value depends on the selected Required BLER.

Remote-control command:

```
SOUR:BB:W3GP:TS25141:AWGN:ENR 8.7dB
```

## Test Case 8.9.1 - CPCH Access Preamble and Collision Detection Preamble Detection in Static Propagation Conditions

This test case is identical to test case 8.8.1 except that the CPCH Preamble is used instead of the RACH preamble.

## Test Case 8.9.3 - Demodulation of CPCH Message in Static Propagation Conditions

This test case is identical to test case 8.8.3 except from differing  $E_b/N_0$  ratio requirements and the demodulation of CPCH Message instead of the RACH Message.

Test requirements in AWGN channel

Transport Block size TB and TTI in frames: 168 bits, TTI = 20 ms / 360 bits, TTI = 20 ms

	$E_b/N_0$ for required BLER < $10^{-1}$	$E_b/N_0$ for required BLER < $10^{-2}$	$E_b/N_0$ for required BLER < $10^{-1}$	$E_b/N_0$ for required BLER < $10^{-2}$
BS with Rx Diversity	4.5 dB	5.4 dB	4.3 dB	5.2 dB
BS without Rx Diversity	7.5 dB	8.4 dB	7.3 dB	8.2 dB

Transport Block Size (TB) - Sets the Transport Block Size:

Test Case 8.9.3

- 168 bits
- 360 bits

Remote-control command:

SOUR:BB:W3GP:TS25141:WSIG:PCPC:CCOD:TYPE TB360



# Digital Standard CDMA2000

## Introduction - Digital Standard CDMA2000

The R&S Vector Signal Generator provides you with the ability to generate signals in accordance with the standard CDMA2000. CDMA2000 is the North American standard for the third mobile radio generation (3G). It is a further development of the North American mobile radio system of the second generation IS-95 (CDMA). The R&S Vector Signal Generator supports the CDMA2000 standard 3GPP2 C.S0002-C, version 1.0, may 2002 (release C). CDMA2000® is a registered trademark of the Telecommunications Industry Association (TIA –USA).

The equipment layout for CDMA2000 signal generation includes the options Baseband Main Module (B13), Baseband Generator (B10/B11) and (Digital Standard CDMA2000 (K46). B10 features a much larger ARB memory size than B11 (see data sheet). But apart from the memory size, both options have the same functionality and are installed alternatively.

In the case of two-path instruments, at least one more option, the Baseband Generator (B10/B11) is required to generate a CDMA2000 signal in the second path. With this option, a CDMA2000 signal can be defined on path B and then either be routed to path A or added to the path A signal with a settable frequency offset. Generating the CDMA2000 signal simultaneously on paths A and B requires an additional, second option, the (Digital Standard CDMA2000 (K46). With a full path B configuration with a second option Baseband Main Module (B13) and an RF section (frequency option B20x) the CDMA2000 signal can be output at RF output B.

The R&S Vector Signal Generator generates the CDMA2000 signals with a chip rate of 1,2288 Mcps, corresponding to the so-called "Spreading Rate 1".

The CDMA2000 signals of the base station are generated in a combination of realtime mode (real time channels) and arbitrary waveform mode. Simulation of bit and block errors can be activated for the channels generated in realtime. In arbitrary waveform mode, the signal is first calculated and then output.

The CDMA2000 signals of mobile station 1 (MS1) are always generated in realtime mode, the signals of the three remaining mobile stations always in arbitrary waveform mode.

The R&S Vector Signal Generator simulates CDMA2000 at the physical channel level. The following list gives an overview of the options provided by the R&S Vector Signal Generator for generating a CDMA2000 signal:

- Configuration of up to 4 base stations or 4 mobile stations.
- Real time generation of one traffic channel and the SYNC channel on the downlink
- All special channels and up to 78 channels on the downlink (depending on the radio configuration)
- Packet channel according to 1xEV-DV on the downlink
- Operating modes "Traffic", "Access", "Enhanced Access" and "Common Control" on the uplink.
- "Misuse For Output Power Control" parameter for varying the original normal transmit power over time
- Simulation of up to 64 additional mobile stations
- Clipping for reducing the crest factor
- All channel coding modes included in IS-2000 (Frame Quality Indicator, Convolutional Encoder, Turbo Encoder, Symbol Puncture, Interleaver, etc)
- Feeding through of bit errors (to test a BER tester) and block errors (to test a BLER tester)

Table 4-25 Parameters of the modulation system CDMA2000

Parameter	Value
Spreading rate	1.2288 MHz
Channel types	Downlink : Forward Pilot (F-PICH) Sync (F-SYNC) Paging (F-PCH) Transmit Diversity Pilot (F-TDPICH) Auxiliary Pilot (F-APICH) Auxiliary Transmit Diversity Pilot (F-ATDPCH) Broadcast (F-BCH) Quick Paging (F-QPCH) Common Power Control (F-CPCCH) Common Assignment (F-CACH) Forward Common Control (F-CCCH) Packet Channels Forward Packet Data Control (F-PDCCH) Forward Packet Data (F-PDCH) Traffic Channels Forward Dedicated Control (F-DCCH) Forward Fundamental (F-FCH) Forward Supplemental (F-SCH) Uplink : Reverse Pilot (R-PICH) Access (R-ACH) Enhanced Access (R-EACH) Reverse Common Control (R-CCCH) Traffic Channel Reverse Dedicated Control (R-DCCH) Reverse Fundamental (R-FCH) Reverse Supplemental Code (R-SCCH) Reverse Supplemental (R-SCH)
Channel count	In downlink 4 base stations each with up to 78 code channels (depending on the radio configuration). In uplink 4 mobile stations with up to 8 code channels (depending on the radio configuration).
Radio configuration	RC 1 – RC 5 & RC10
Frame length	Radio frame: 5 ms, 10 ms, 20 ms, 40 ms, 80 ms, 160 ms (depending on the channel type and the radio configuration)
PN offset	0 ... 511
Quasi Orthogonal Walsh Set	Set 1 – set 3
Channel coding	All channel coding modes included in IS-2000 (Frame Quality Indicator, Convolutional Encoder, Turbo Encoder, Symbol Puncture, Interleaver, etc)
Long Code Mask	0 ... 3FF FFFF FFFF hex

**Note:**

*In the description of the Windows software WinIQSIM, which is supplied with the option R&S SMx-B10/B11 (Baseband Generator), some of the CDMA2000 signals are explained in detail. You will find the description on the supplied CD.*

# Modulation System CDMA2000

The following simplified diagram is used to explain the system principle of CDMA2000 in the forward (down) and reverse (up) link. The exact system configuration depends on parameters like link direction, spreading rate, mode, radio configuration and channel type. A detailed description cannot be given in this manual. For further information refer to the IS2000 standard

## Modulation System CDMA2000 in the Downlink (Forward)

The following block diagram shows the components of the CDMA2000 transmission system in the downlink.

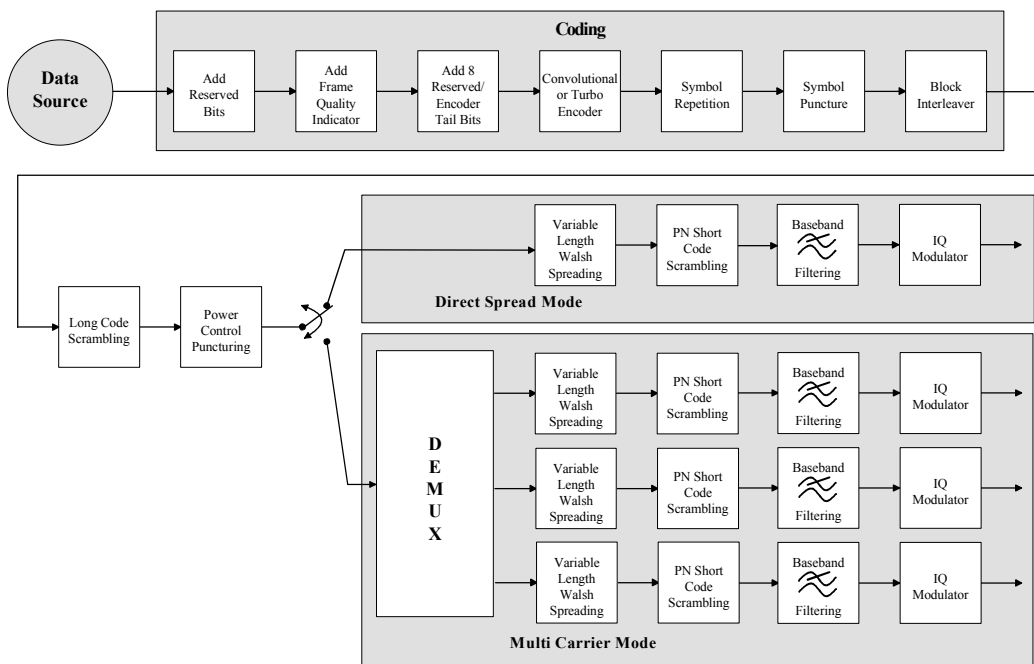

Fig. 4-42 Components of the CDMA2000 transmission system in the downlink (forward)

## Modulation System CDMA2000 in the Uplink (Reverse)

The following block diagram shows the components of the CDMA2000 transmission system in the uplink.

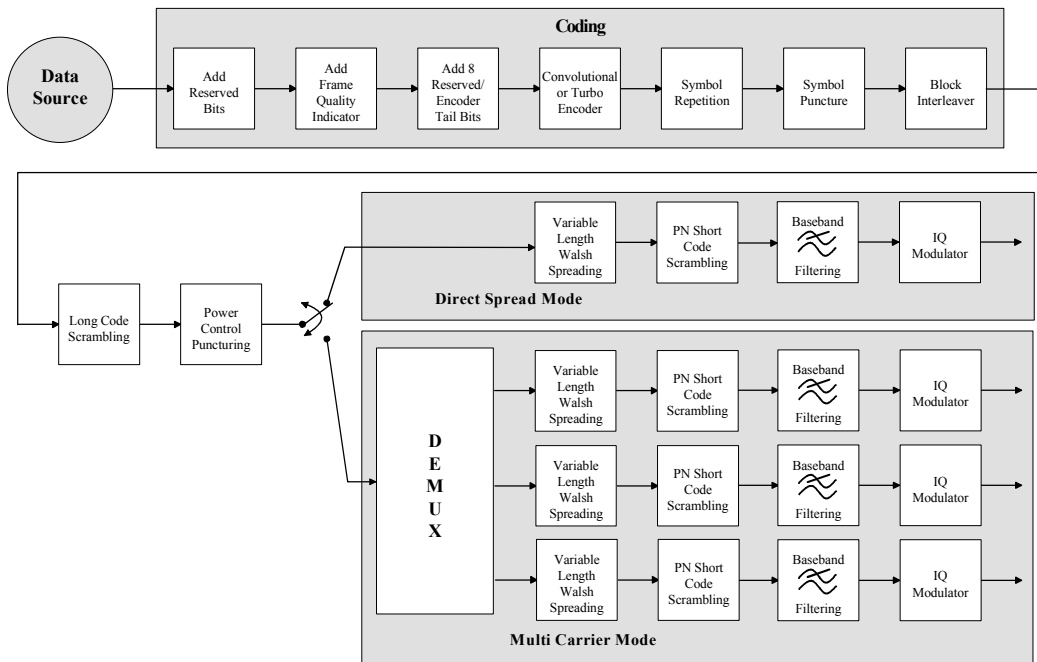

Fig. 4-43 Components of the CDMA2000 transmission system in the uplink (reverse)

## Data Source - Uplink and Downlink

The data fields of all channels can be filled from all possible data sources of the R&S Vector Signal Generator: pattern (all1, all0, user-defined up to 64 bits), PRBS data, data lists and external data.

## Channel Coding - Uplink and Downlink

In contrast to 3GPP FDD, channel coding with CDMA2000 is part of the physical layer. The channel coding procedure may slightly vary depending on channel type, frame length and data rate. The basic coding procedure is illustrated by the coding block in the diagram above. Blocks like 'Add reserved bits' or 'Symbol puncture' are not used in all coding scenarios. For a more exact definition refer to the standard.

- Add Reserved Bits:** filled with “0” bits
- Add Frame Quality Indicator:** calculation and insertion of a CRC (cyclic redundancy code) checksum for error identification.

**Add 8 Reserved/Encoder**

- Tail Bits:** reserved, tail bits which set the subsequent coder to a defined final state.
- Convolutional or Turbo Encoder:** error correction code, depending on data rate and other parameters either by convolutional coding or turbo codes.
- Symbol Repetition:** symbol repetition is used together with block symbol puncture for adapting the convolutional or turbo coder output data rate to the required input data rate of the interleaver.
- Symbol Puncture:** symbol puncturing (elimination) is used together with block symbol repetition for adapting the convolutional or turbo coder output data rate to the required input data rate of the interleaver.
- Block Interleaver:** blockwise permutation of input data sequence of interleaver to reduce bit errors.

## Long-Code Scrambling Generator - Downlink

The long-code generator is also referred to as scrambling code generator since it scrambles the chip sequence in a user-specific way (long-code mask).

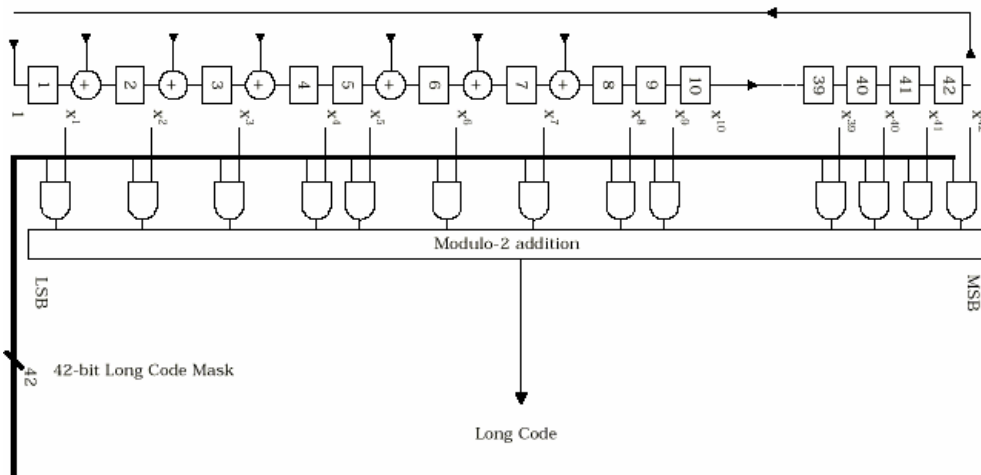

Fig. 4-44 Long-code generator CDMA2000

The long-code generator is a feedback 42-bit shift register with its status vector linked to a user-specific long-code mask to form the specific long-code sequence.

The generator polynomial of the shift-register section of the long-code generator is:

$$p(x) = x^{42} + x^{35} + x^{33} + x^{31} + x^{27} + x^{26} + x^{25} + x^{22} + x^{21} + x^{19} + x^{18} + x^{17} + x^{16} + x^{10} + x^7 + x^6 + x^5 + x^3 + x^2 + x^1 + 1$$

A real long code is used in the forward link. In the reverse link a complex long code with I and Q component is required. The long code for the I component is derived directly from the 1X generator, that for the Q component corresponds to the I long code delayed by one chip.

## Power Control Puncturing - Downlink

To control the output power of the mobile station, the base station sends power control bits in the traffic channel at an 800 Hz rate instead of the scrambled data bits. Depending on the power control bits, the mobile station increases or reduces its output power.

## Variable-Length Walsh Spreading - Downlink

Spreading of the CDMA2000 signal is performed in this block. Walsh codes with a variable spreading factor are used. The spreading factor and the Walsh code depend on the spreading rate, channel type, frame length and data rate. To extend the base-station capacity, so-called 'quasi-orthogonal Walsh sets' can be used in addition to the Walsh codes. The input data stream of the spreading unit is already complex ( $I + jQ$ ). If a standard Walsh code is used, spreading is performed by multiplying the input symbol (modulo 2 multiplication) with the real Walsh code. The quasi-orthogonal Walsh code results in complex spreading through an additional rotation of the output phase (the spreading code then consists of a real and an imaginary part).

## PN Short-Code Scrambling - Downlink

The (complex) input data stream of the PN short-code scrambler is multiplied by a complex PN sequence ( $I_{PN} + j Q_{PN}$ ). This is also called 'quadrature spreading'. With channels of the radio configurations 1 and 2, whose generation is comparable with that of IS-95 systems, this block splits up the input stream in I and Q components.

The base-station-specific parameter PN offset determines the start phase of these PN short-code sequences. This permits signals of different base stations to be distinguished.

Generator polynomial for I and Q components of the PN short code:

$$P_I(x) = x^{15} + x^{13} + x^9 + x^8 + x^7 + x^5 + 1$$

$$P_Q(x) = x^{15} + x^{12} + x^{11} + x^{10} + x^6 + x^5 + x^4 + x^3 + 1$$

The period of a PN short-code sequence is 26.666 ms.

## Spreading - Uplink

Increasing the data rate or spreading in the reverse link is performed in different ways depending on the radio configuration and the channel type.

### Variable Length Walsh Spreading

Walsh codes with a variable spread factor are used for spreading. The spreading factor and the Walsh code depend on the spreading rate, channel type, frame length and the data rate. Spreading is obtained by multiplication of the input symbol (modulo 2 multiplication) by the real Walsh code.

### 64-ary Orthogonal Modulator

Groups of 6 input bits are used for addressing a line of the Walsh code table with the spread code length of 64. This 'modulator' increases the data rate by a factor of 64/6. This type of rate increase comes from IS-95 and is mainly used in the radio configurations 1 and 2.

## Scrambling - Uplink

In the scrambling block of the uplink system the spread data stream is scrambled by means of the long code and the PN short code. Different methods are used for the radio configurations 1, 2 and RC3 to RC5.

### Scrambling for Radio Configuration 1 and 2

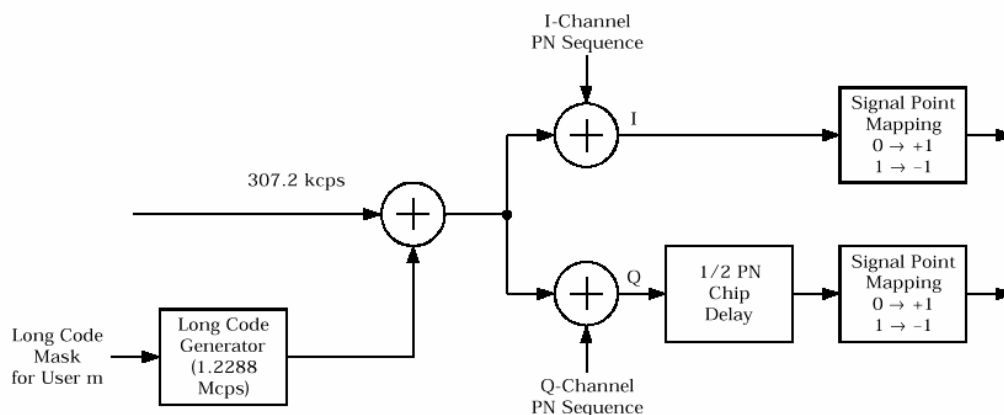

Fig. 4-45 Scrambling in the uplink RC 1 and RC2

The output data stream of the spreading block is scrambled with the **long code**. The rate is increased in addition by a factor of four. The long-code generator is also referred to as scrambling code generator since it scrambles the chip sequence in a user-specific way (long-code mask). This generator exactly corresponds to that described in section "[Long-Code Scrambling Generator - Downlink](#)" for the downlink.

The real input data stream of the **PN short-code** scrambler is multiplied by a complex PN sequence ( $I_{PN} + j Q_{PN}$ ). This procedure is also called 'quadrature spreading'. With channels of the radio configurations 1 and 2, whose generation is comparable with that of IS-95 systems, this block splits up the input stream in I and Q components.

In contrast to the downlink, no variable PN offset parameter is available for the PN short code in the reverse link. The PN offset is always 0.

Different generation rules are used for the PN short codes depending on the mode and spreading rate. The generator polynomials of the PN short codes correspond to those in the downlink (see section "[PN Short-Code Scrambling - Downlink](#)"). The I and Q data streams consisting of  $\{0, 1\}$  sequences are then mapped to  $\{+1, -1\}$  in the **signal point mapping** block.

Because of the delay of the Q component, offset QPSK constellation known from the reverse link of IS-95 is obtained from the QPSK constellation. Due to the Q delay, the transfer of the I and Q signal components from one chip to the next is never synchronous. For this reason there are no zero crossings in the transfer from one chip to the next. This behavior can be seen in the vector diagram below.

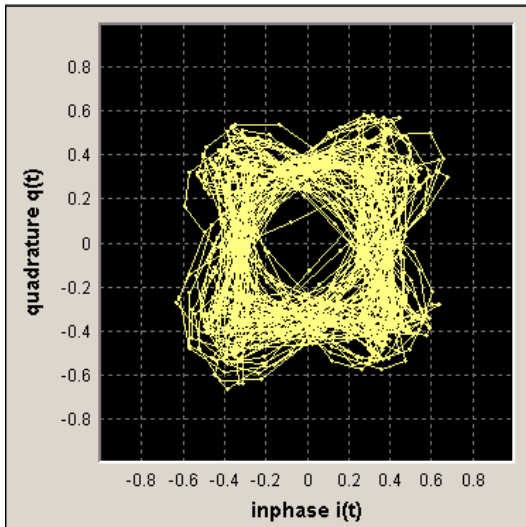
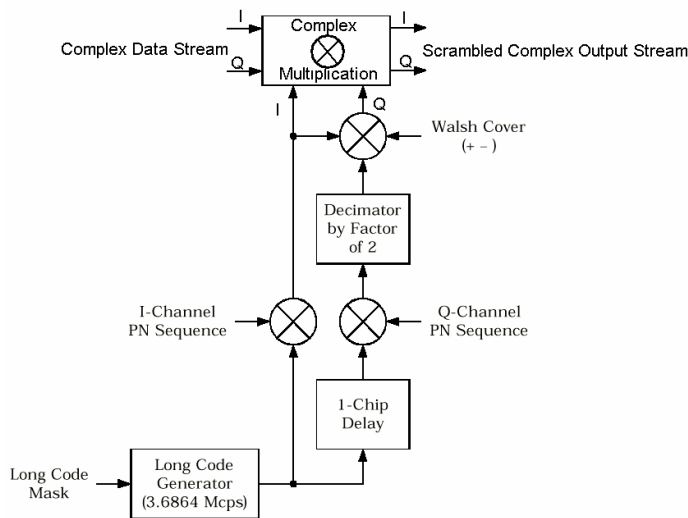

Fig. 4-46 Scrambling in the uplink RC 1 and RC2

### Scrambling for Radio Configuration 3,4 and 5



### Scrambling in the uplink RC3, RC4 and RC5

Here too, the long-code generator defined in section "[Long-Code Scrambling Generator - Downlink](#)" for the downlink is used. A complex long-code sequence is required. For this purpose, the output sequence of the generator is used as the I component and the sequence delayed by one chip as the Q component.

The I component of the long code is then multiplied by the I component of the PN short code, the Q component with the corresponding Q component of the PN short code. The definition of the PN short code is given in section "[PN Short-Code Scrambling - Downlink](#)".

The subsequent operations **decimation by factor of 2** and linking the Q component to the Walsh sequence (+-) and the I component serve for reducing the zero crossings of the I/Q signal at the end of the whole scrambling process. Thus a behavior similar to that in the uplink of 3GPP is obtained. It is also known as **HPSK** (hybrid phase shift keying).



The resulting I/Q output stream is obtained by complex multiplication (modulo 2) of the I/Q input sequence of the scrambler by the complex scramble sequence obtained from the long code and the PN short code. The constellation obtained is a combination of QPSK and offset QPSK.

In this mode, the traffic data streams of a channel are mapped either to the I or to the Q path of the complex data stream shown in the diagram above. With these so-called BPSK channels, the channel component at the scrambler input consists of a real or an imaginary component. As can be seen in the table below, the constellation after complex scrambling is again at the angle bisector.

Table 4-27 Output combinations with BPSK channels

d(n) \ S-Code(n)	-1-j	-1+j	+1-j	+1+j
-1	+1+j	+1-j	-1+j	-1-j
+1	-1-j	-1+j	+1-j	+1+j
-j	-1+j	+1+j	-1-j	+1-j
+j	+1-j	-1-j	+1+j	-1+j

## Baseband Filtering - Uplink and Downlink

This block performs baseband filtering (pulse shaping and band limiting) of the I/Q signal. In addition to the filters specified in the standard, the signal generator also provides equalizer filters with a better adjacent-channel leakage ratio.

## I/Q Modulator - Uplink and Downlink

The IQ modulator defined in the IS2000 standard differs from the definition in the R&S Vector Signal Generator. The definition on which the R&S Vector Signal Generator is based is used by virtually all digital communication standards (except IS95 and IS2000).

In the final step, the filtered IQ signal is modulated to the desired RF in a different way in the IQ modulator:

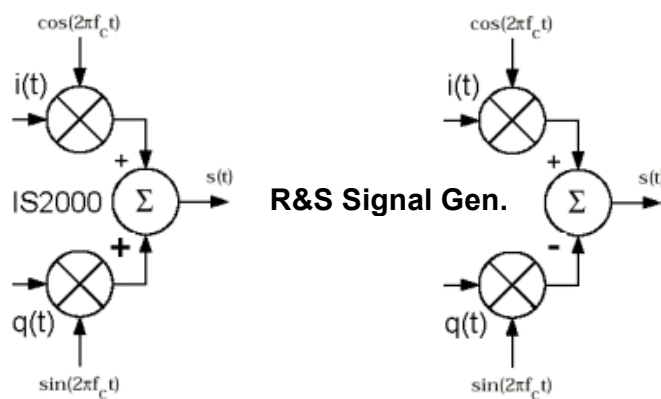

Fig. 4-47 Definition of IQ modulator in IS2000 and R&S Vector Signal Generator

According to IS2000, the RF signal  $s(t)$  is derived from the baseband I/Q signal as follows:

The R&S Vector Signal Generator is based on the following definition:

The R&S Vector Signal Generator enables baseband signals to be generated according to IS2000 (cdma2000 standard) by inverting the Q-part of the signal.

So that this baseband signal can be used to generate an RF signal which also conforms to the standard, the **I/Q Modulator** menu contains the **I/Q Swap** function for swapping the I/Q control of the I/Q modulator.

## Constellation of I/Q Signals - Downlink

Depending on radio configuration and channel type, the signal components in the different channels create different sub-constellations.

### BPSK channels

With some channel types (particularly in RC1 and 2 but always in the pilot channel, for instance) the data stream is split up in I and Q components in the **PN Short Code Scrambling** block. The input data stream of this block is a real  $\pm 1$  sequence similar to BPSK. The complex output data sequence is then as follows:

$$S_{out}(n) = d_{in}(n) (PN_I(n) + j PN_Q(n)), \text{ with } d_{in}(n), PN_I(n), PN_Q(n) \in \{-1, +1\}.$$

This yields four different output combinations for  $S_{out}$ :

$$(-1 -j), (-1 +j), (+1 -j), (+1 +j),$$

ie. all points are on one of the two angle bisectors at the I/Q level.

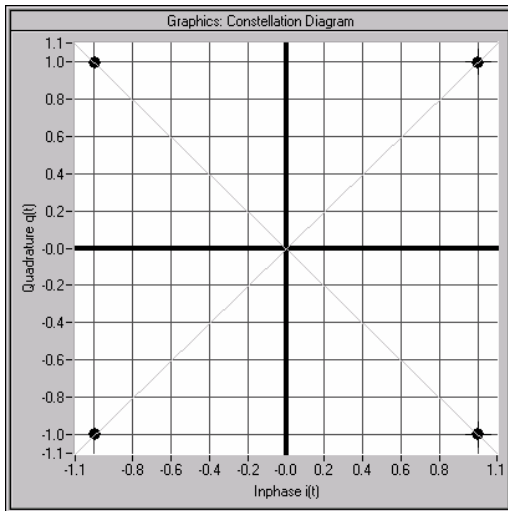

Fig. 4-48 Constellation diagram of a BPSK channel with 0 dB power

**QPSK channels**

With other channel types, the input data stream of the **PN Short Code Scrambling** block is a complex  $\pm 1 \pm j$  sequence similar to QPSK. The complex output data sequence is then as follows:

$$S_{out}(n) = (d_I(n) + j d_Q(n)) (PN_I(n) + j PN_Q(n)), \text{ with } d_I(n), d_Q(n), PN_I(n), PN_Q(n) \in \{-1, +1\}.$$

Table 4-28 Output combinations with QPSK channels

PN(n) \ d(n)	-1-j	-1+j	+1-j	+1+j
-1-j	+2j	+2	-2	-2j
-1+j	+2	-2j	+2j	-2
+1-j	-2	+2j	-2j	+2
+1+j	-2j	-2	+2	+2j

This again yields four different output combinations for  $S_{out}$ :

-2j, 2j, -2, 2,

i.e. all points are on one of the two axes at the I/Q level.

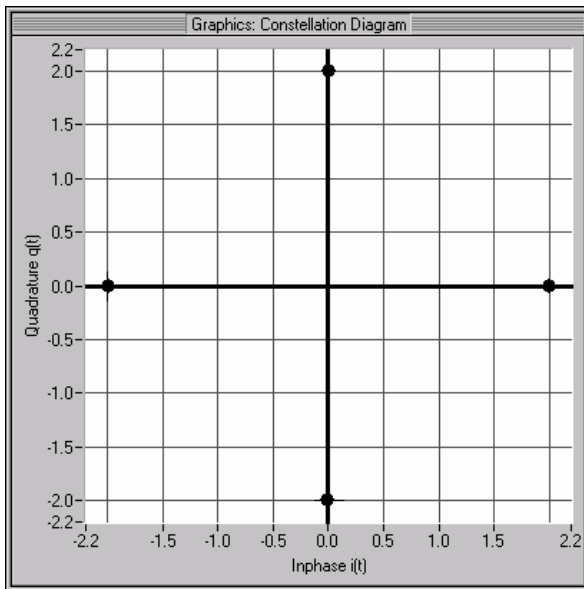

Fig. 4-49 Constellation diagram of a QPSK channel with 0 dB power

**Power Control - CDMA2000 - Downlink and Uplink**

After spreading and scrambling, a channel-specific power factor  $p$  is applied to the signal. For example, a value of -6 dB therefore results in half the level (or  $\frac{1}{4}$  power) and the following diagram.

# CDMA2000 Menu

The menu for setting the CDMA2000 digital standard is either called from the baseband block or from the menu tree under Baseband.

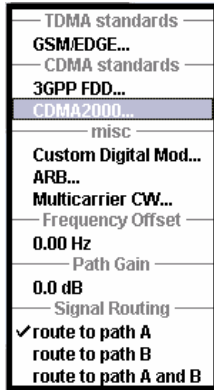

The menu is split into several sections for configuring the standard. The choice of transmission direction determines which displays and parameters are made available in the lower section.

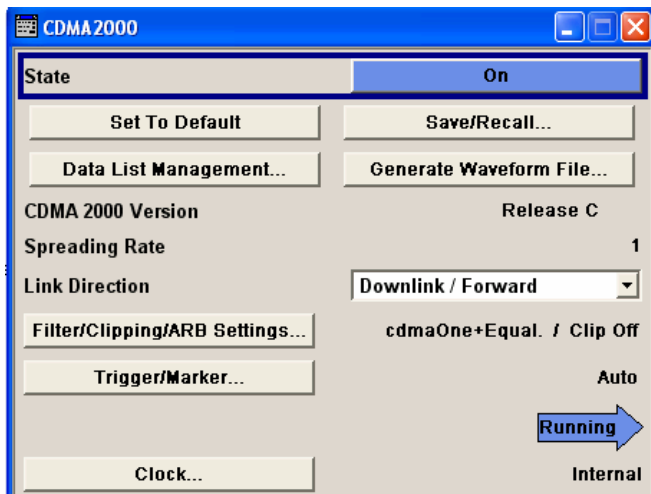

The upper section of the menu is where the CDMA2000 digital standard is enabled, the default settings are called and the transmission direction selected.

The valid CDMA2000 version and the spreading rate in use are displayed.

Many of the buttons lead to submenus for loading and saving the CDMA2000 configuration and for setting the filter, trigger and clock parameters.

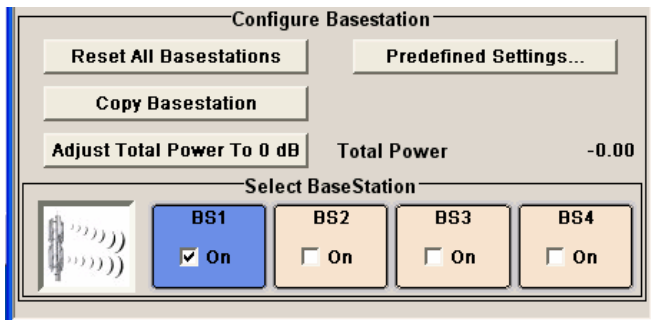

The lower menu section is where either the base station signal or the mobile station signal is configured, depending on the transmission direction selected.

## General Settings for CDMA2000 Signals

The upper menu section is where the CDMA2000 digital standard is enabled and reset and where all the settings valid for the signal in both transmission directions are made.

### State - CDMA2000

Enables/disables the CDMA2000 standard.

Enabling this standard disables all the other digital standards and digital modulation modes on the same path.

The CDMA2000 signal is generated by a combination of realtime mode (real time channels) and arbitrary waveform mode (all the other channels).

On the downlink, one traffic channel and the SYNC channel of base station 1 are generated in realtime. All the other channels are generated in arbitrary waveform mode and added.

In the uplink, all the channels of mobile station 1 are generated in realtime, the other mobile stations are generated in arbitrary waveform mode and added to the realtime signal.

Remote-control command:

SOUR:BB:C2K:STAT ON

### Set to Default - CDMA2000

Calls the default settings . The following table gives an overview of the settings. The preset value for each parameter is specified in the description of the remote-control commands.

Remote-control command:

SOUR:BB:C2K:PRES

Parameter	Value
State	Not affected by Set to default
Link Direction	Downlink
Filter	CdmaOne + Equalizer
Clipping	Off
Trigger	Auto
Clock	Internal
<b>Base Station Configuration</b>	
State	Off
Radio Configuration Traffic Channels 1 and 2	RC3
Radio Configuration other Traffic Channels	RC1
Time Delay	0 chips
PN Offset	0
Transmit Diversity	Off
Quasi Orthogonal Walsh Set	1
<b>Mobile Station Configuration</b>	
State	Off
Mode	Traffic
Radio Configuration	RC3
Channel Coding	Complete
LC Mask (hex)	0
State (all Channels)	Off
Power Control	Off

**Save/Recall ... - CDMA2000** Calls the **Save/Recall** menu.

From the **Save/Recall** menu the **File Select** windows for saving and recalling CDMA2000 configurations and the **File Manager** can be called.



CDMA2000 configurations are stored as files with the predefined file extension **\*.cdma2k**. The file name and the directory they are stored in are user-definable.

The complete settings in the **CDMA2000** menu are saved and recalled.

**Recall CDMA2000 Setting**

Opens the **File Select** window for loading a saved CDMA2000 configuration.

The configuration of the selected (highlighted) file is loaded by pressing the **Select** button.

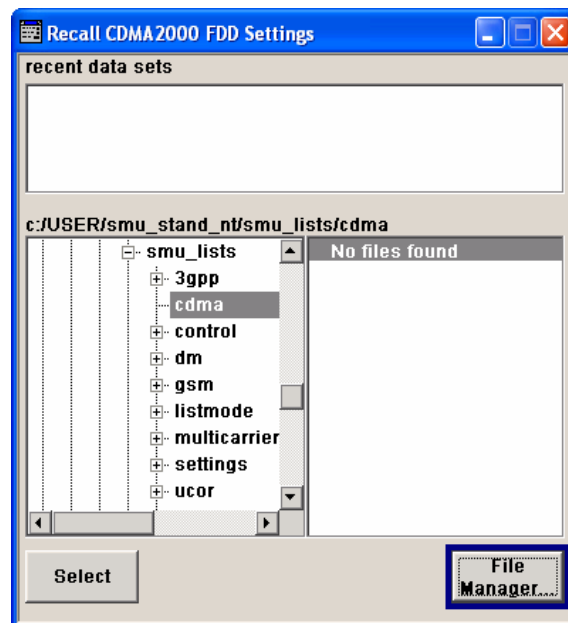

Remote-control command:

```
:MMEM:CDIR 'F:\gen_lists\cdma'
```

```
SOUR:BB:C2K:SETT:CAT?
```

```
Response: 'cdma2k_1',cdma2k_2'
```

```
SOUR:BB:C2K:SETT:LOAD "cdma2k_1"
```

### Save CDMA2000 Setting

Opens the **File Select** window for saving the current CDMA2000 signal configuration.

The name of the file is specified in the **File name** entry field, the directory selected in the **save into** field. The file is saved by pressing the **Save** button.

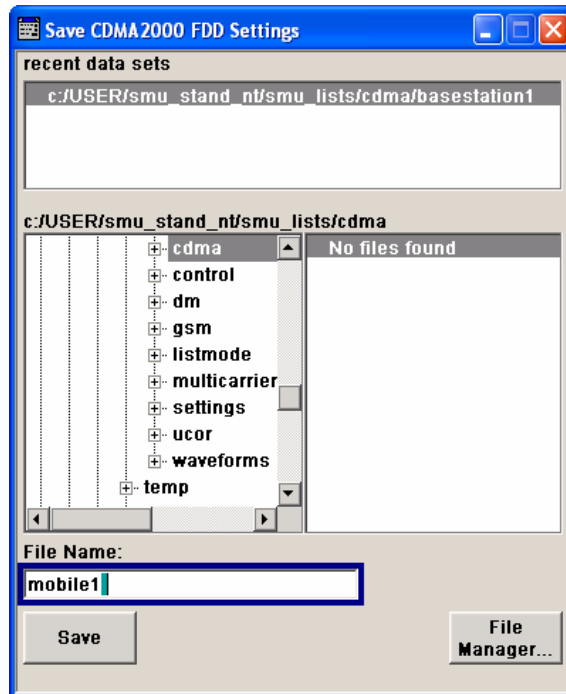

Remote-control command:

```
:MMEM:CDIR 'F:\gen_lists\cdma'
```

### File Manager

```
SOUR:BB:C2K:SETT:STOR 'cdma2k_1'
```

Calls the **File Manager**.

The **File Manager** is used to copy, delete and rename files and to create new directories.

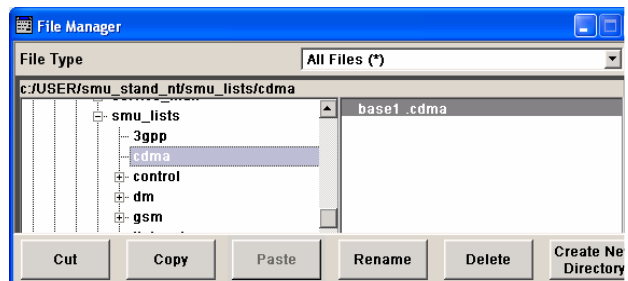

Remote-control commands: :

```
:MMEM:CDIR 'F:\gen_lists\cdma'
```

```
SOUR:BB:C2K:SETT:DEL 'cdma2k_1'
```

**Data List Management -  
CDMA2000**

Calls the **Data List Management** menu. This menu is used to create and edit a data list.

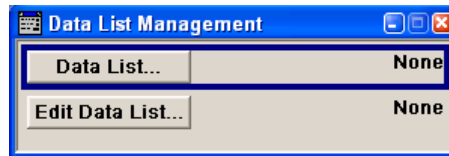

All data lists are stored as files with the predefined file extension **\*.dm\_iqd**. The file name and the directory they are stored in are user-definable.

The data lists must be selected as a data source from the submenus under the individual function, e.g. in the channel table of the base stations.

Remote-control commands:

**Note:**

*All data lists are generated and edited by means of the **SOURce:BB:DM** subsystem commands. Files containing data lists usually end with **\*.dm\_iqd**. The data lists are selected as a data source for a specific function in the individual subsystems of the digital standard.*

**Creating and editing the data list:**

```
:SOUR:BB:DM:DLIS:SEL "d_list1"
:SOUR:BB:DM:DLIS:DATA #B1111010101000001111....
:SOUR:BB:DM:DLIS:DATA:APP #B1111010101000001111....
```

**Selecting the data list:**

```
SOUR:BB:C2K:BST2:CGR3:COFF1:DATA DLIS
SOUR:BB:C2K:BST2:CGR3:COFF1:DATA:DSEL "cdma_bs1"

SOUR:BB:C2K:BST2:CGR3:COFF1:TPC:DATA DLIS
SOUR:BB:C2K:BST2:CGR3:COFF1:TPC:DATA:DSEL "d_dwn1"

SOUR:BB:C2K:MST2:CHAN2:DATA DLIS
SOUR:BB:C2K:MST2:CHAN2:DSEL "d_up1"

SOUR:BB:C2K:MST2:TPC:DATA DLIS
SOUR:BB:C2K:MST2:TPC:DATA:DSEL "d_up1"
```



**Generate Waveform File -  
CDMA2000**

Opens the submenu for storing the current CDMA2000 signal as ARB signal in a waveform file. This file can be loaded in the ARB menu and processed as multicarrier or multisegment signal.

The file name is entered in the submenu. The file is stored with the predefined file extension \*.**wv**. The file name and the directory it is stored in are user-definable.

Remote-control commands:

```
SOUR:BB:C2K:WAV:CRE "c:\temp\cdma2k_wv"
```

**CDMA 2000 Version -  
CDMA2000**

Displays the current version of the CDMA2000 standard.

The default settings and parameters provided are oriented towards the specifications of the version displayed.

Remote-control command:

```
SOUR:BB:C2K:VERS?
```

```
Response: Release C
```

**Spreading Rate -  
CDMA2000**

Displays the spreading rate.

Mode Spreading Rate 1 (**Direct Spread 1X**) is used:

The **Chip Rate** parameter which determines the rate of the spread symbols as is used for signal output, can be varied in the Filter, Clipping, ARB Settings menu (see section "[Filtering, Clipping, ARB Settings - CDMA2000](#)", page 4.555).

Remote-control command:

```
SOUR:BB:C2K:CRAT?
```

```
Response: R1M2
```

**Link Direction - CDMA2000**

Selects the transmission direction.

The settings of the base station or the mobile station are provided in the following menu section in accordance with the selection.

**Downlink/  
Forward Link**

The transmission direction selected is base station to mobile station. The signal corresponds to that of a base station.

Remote-control command:

```
SOUR:BB:C2K:LINK DOWN
```

**Uplink/  
Reverse Link**

The transmission direction selected is mobile station to base station. The signal corresponds to that of a mobile station.

Remote-control command:

```
SOUR:BB:C2K:LINK UP
```

**Filtering, Clipping, ARB Settings - CDMA2000**

Calls the menu for setting baseband filtering, clipping and the sequence length of the arbitrary waveform component. The current setting is displayed next to the button.

The menu is described in Section "[Filtering, Clipping, ARB Settings - CDMA2000](#)", page 4.555.

Remote-control command: -

**Trigger - Marker - CDMA2000**

Calls the menu for selecting the trigger source, for configuring the marker signals and for setting the time delay of an external trigger signal (see Section "[Trigger-Marker-Clock - CDMA2000](#)", page 4.560).

The currently selected trigger source is displayed to the right of the button.

Remote-control command: -

**Execute Trigger (Trigger Source Internal only)**

Executes trigger manually.

A manual trigger can be executed only when an internal trigger source and a trigger mode other than **Auto** have been selected.

Remote-control commands:

SOUR:BB:C2K:TRIG:SOUR INT

SOUR:BB:C2K:SEQ RETR

SOUR:BB:C2K:TRIG:EXEC

**Clock - CDMA2000**

Calls the menu for selecting the clock source and for setting a delay (see Section "[Trigger-Marker-Clock - CDMA2000](#)", page 4.560).

Remote-control command: -

## Configure Base Station or Mobile Station - CDMA2000

Depending on the transmission direction selection, the central section of the menu provides either the **Configure Base Station** section (selection **Downlink/Forward Link** ),

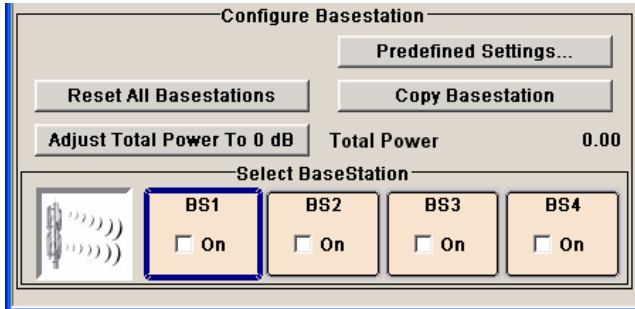

or the **Configure Mobile Station** section (selection **Uplink/Reverse Link**).

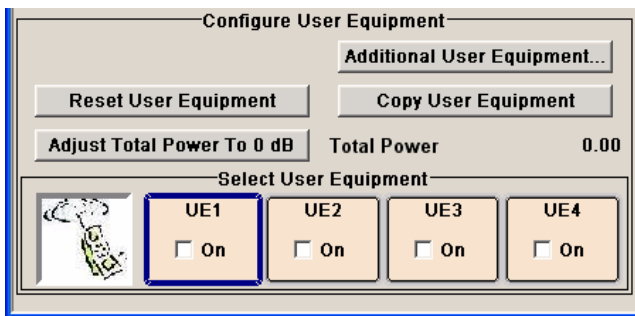

**Predefined Settings  
Downlink - CDMA2000**

Calls menu for setting predefined configurations.

The menu is described in Section "[Predefined Settings Downlink - CDMA2000](#)", Page 4.551.

Remote-control command: -

**Additional Mobile Station -  
CDMA2000**

Calls menu for simulating up to 64 additional mobile stations.

The menu is described in Section "[Additional Mobile Station - Uplink - CDMA2000](#)", Page 4.571.

Remote-control command: -

**Reset All Base Stations -  
CDMA2000**

Resets all base stations to the predefined settings. The following table gives an overview of the settings. The preset value for each parameter is specified in the description of the remote-control commands..

Remote-control command:  
SOUR:BB:C2K:BST:PRES

Parameter	Value
Base Station Configuration	
State	Off
Time Delay	0 chips
PN Offset	0
Transmit Diversity	Off
Quasi Orthogonal Walsh Set	1
State (all channels)	Off
Frame Length (0-5 / 0-7/ 0-10)	26.6 ms / 40 ms / 5 ms
Frame Length (all other channels)	20 ms
Data Rate (0-6,0-10,0-11,1-1,1-4,2-1,2-4)	9.6 kbps
Data Rate (0-7,0-9,1-2,1-3,2-2,2-3)	19.2 kbps
Data Rate (all other channels)	1.2 kbps
Walsh (0-2 / 0-5)	16 / 32
Walsh (1-1 / 1-2 / 1-3 / 2-1 / 2-2 / 2-3)	8 / 17 / 18 / 9 / 19 / 20
Walsh (all other channels)	0
Power (0-1 / 0-6 )	-7 dB / -6.62 dB
Power (0-5 , 1-1, 2-1 / 1-2, 1-3, 2-2, 2-3)	-12.72 dB / -9.72 dB
Power (all other channels)	0 dB
Data Source (0-1, 0-2, 0-3, 0-4)	All0
Data Source (all other channels)	PN9
Channel Coding (all Channels)	Complete

**Reset All Mobile Stations -  
CDMA2000**

Resets all mobile stations to the predefined settings. The following table gives an overview of the settings. The preset value for each parameter is specified in the description of the remote-control commands.

Remote-control command:  
SOUR:BB:C2K:MST:PRES

Parameter	Value
Mobile Station Configuration	
State	Off
Mode	Traffic
Radio Configuration	3
Channel Coding	Complete
LC Mask (hex)	0
State (all Channels)	Off
Frame Length	20 ms
Data Rate (2 / 3,4,5)	9.6 kbps / 1.5 kbps
Walsh (0 / 8 / 4 / 2 / 6)	0 / 8 / 4 / 2 / 6
Spread (2 / 3,4,5)	32 / 16

Parameter	Value
Power	0 dB
Data Source	PN9

**Copy ... - CDMA2000**

Copies the settings of a base or mobile station to a second base or mobile station. A window opens for creating the destination station.

Window for the **Downlink / Forward** transmission direction:

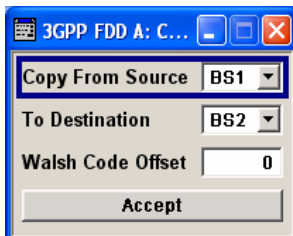

Window for the **Uplink / Reverse** transmission direction:

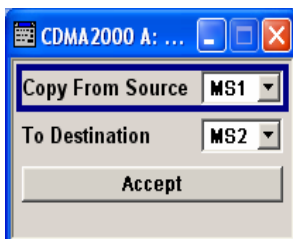

**Copy from Source**

Selects the base station or mobile station whose settings are to be copied.

Remote-control command:

```
SOUR:BB:C2K:LINK UP
SOUR:BB:C2K:COPY:SOUR 1
```

**To Destination**

Selects the base station or mobile station whose settings are to be overwritten.

Remote-control command:

```
SOUR:BB:C2K:COPY:DEST 2
```

**Walsh Code Offset (Base Station only)**

Enters the offset to be applied when copying the base station to the Walsh codes of the destination base station. The minimum value is 0 (Walsh codes are identical), the maximum value is 255.

Remote-control command:

```
SOUR:BB:C2K:COPY:COFF 10
```

**Accept**

Start the copy process.

Remote-control command:

```
SOUR:BB:C2K:COPY:EXEC
```

**Adjust Total Power to 0dB - CDMA2000** Sets the power of an enabled channel so that the total power of all the active channels is 0 dB. This will not change the power ratio among the individual channels.

Remote-control command:  
SOUR:BB:C2K:POW:ADJ

**Total Power - CDMA2000** Displays the total power of the active channels.

The total power is calculated from the power ratio of the powered up code channels with modulation on. If the value is not equal to 0 dB, the individual code channels (whilst still retaining the power ratios) are internally adapted so that the **Total Power** for achieving the set output level is 0 dB.

Remote-control command:  
SOUR:BB:C2K:POW?  
'Response: 0dB

**Select ... - CDMA2000**

Selects the base or mobile station by pressing the accompanying button. This opens a menu for editing the selected base or mobile station.

The menus are described in Sections "[Base Station Configuration - CDMA2000](#)", Page 4.573 and "[Mobile Station Configuration \(MS\)- CDMA2000](#)", Page 4.603.

Remote-control command: -  
(the base station or mobile station is selected by the keyword index BSTation<i> or. MSTation<i> .)

**Base Station or Mobile Station On - CDMA2000**

Activates or deactivates the base or mobile station.

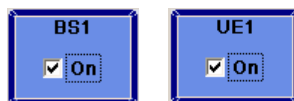

Remote-control command:  
SOUR:BB:C2K:BST1:STAT ON | OFF  
SOUR:BB:C2K:MST2:STAT ON | OFF

## Filtering, Clipping, ARB Settings - CDMA2000

The **Filtering, Clipping, ARB Settings** menu is reached via the **CDMA2000** main menu.

The filter parameters (**Filter** section), clipping (**Clipping** section) and the sequence length of the arbitrary waveform component (**ARB Settings** section) are defined in this menu. Generation of baseband signals according to IS2000 (cdma2000 standard) by inverting the Q-part of the signal is enabled in the **I/Q Settings** section.

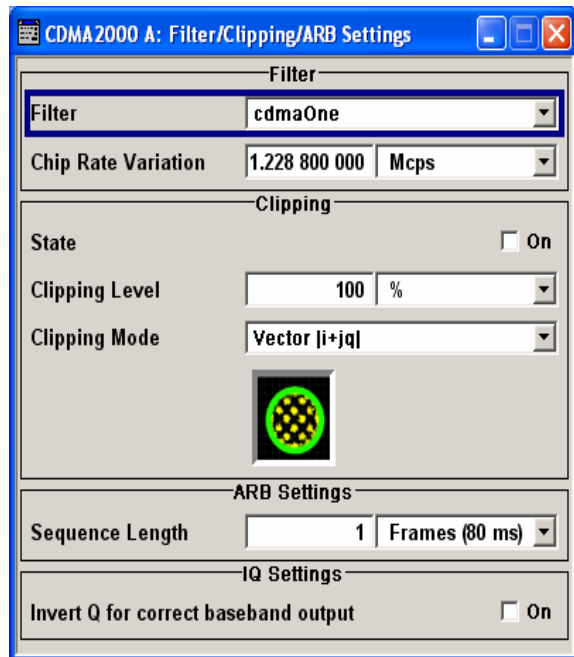

### Filter - CDMA2000

Selects baseband filter.

This opens a selection window containing all the filters available to the instrument.

The filter types are described in Section "[Baseband Filter - Custom Digital Mod](#)".

#### CdmaOne

Uplink filter according to standard.

Remote-control command:

SOUR:BB:C2K:FILT:TYPE CONE

#### CdmaOne+ Equalizer

Downlink filter according to standard.

Remote-control command:

SOUR:BB:C2K:FILT:TYPE COEQ

#### CdmaOne 705kHz

Non-standard filter for the uplink. This filter achieves better adjacent-channel leakage ratio.

Remote-control command:

SOUR:BB:C2K:FILT:TYPE COF705

#### CdmaOne 705kHz+ Equalizer

Non-standard filter for the downlink. This filter achieves better adjacent-channel leakage ratio.

Remote-control command:

SOUR:BB:C2K:FILT:TYPE COF

**Roll Off Factor or BxT -  
CDMA2000**

Enters the filter parameters.

The filter parameter offered (Roll Off factor or BxT) depends on the currently selected filter type. This parameter is always set to the default for each of the predefined filters.

Remote-control commands:

```
SOUR:BB:C2K:FILT:PAR:APCO25 0.2
SOUR:BB:C2K:FILT:PAR:COS 0.35
SOUR:BB:C2K:FILT:PAR:GAUS 0.5
SOUR:BB:C2K:FILT:PAR:PGA 0.5
SOUR:BB:C2K:FILT:PAR:RCOS 0.35
SOUR:BB:C2K:FILT:PAR:SPH 2
```

**Chip Rate Variation -  
CDMA2000**

Enters the chip rate.

The chip rate entry changes the output clock and the modulation bandwidth.

Remote-control command:

```
SOUR:BB:C2K:CRAT:VAR 1228800
```

**Clipping State - CDMA2000**

Switches baseband clipping on and off.

Baseband clipping is a very simple and effective way of reducing the crest factor of the CDMA signal.

CDMA signals may have very high crest factors particularly with many channels and long sequences. High crest factors entail two basic problems:

- The nonlinearity of the power amplifier (compression) causes intermodulation which expands the spectrum (spectral regrowth).
- Since the level in the D/A converter is relative to the maximum value, the average value is converted with a relatively low resolution. This results in a high quantization noise.

Both effects increase the adjacent-channel power.

With baseband clipping, all the levels are limited to a settable value (**Clipping Level**). This level is specified as a percentage of the highest peak value. Since clipping is done prior to filtering, the procedure does not influence the spectrum. The EVM however increases.

Since clipping the signal not only changes the peak value but also the average value, the effect on the crest factor is unpredictable. The following table shows the effect of the **Clipping** on the crest factor for typical scenarios.

Remote-control command:

```
SOUR:BB:C2K:CLIP:STAT ON
```



The following pictures demonstrate the affect of clipping with vector mode ( $|i+q|$ ), using a signal configuration with 2 active channels.

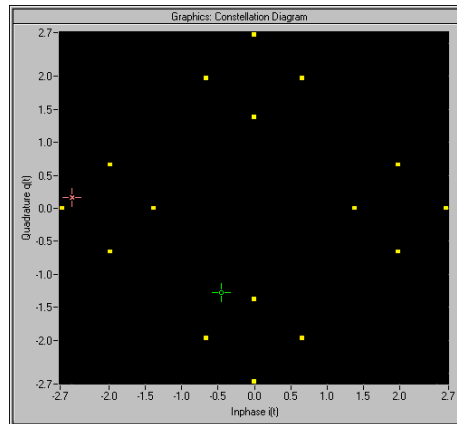

Fig. 4-50 Constellation diagram of the signal without clipping, shows the level mapping

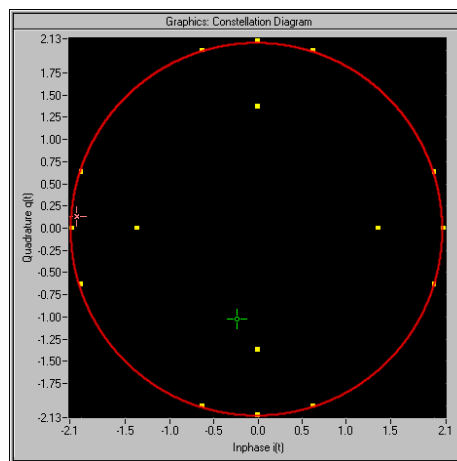

Fig. 4-51 Constellation diagram with clipping level 80 %, vector mode ( $|i+q|$ ) The circle emphasizes the changed constellation points.

**Clipping Level- CDMA2000** Sets the limit for clipping.

This value indicates at what point the signal is clipped. It is specified as a percentage, relative to the highest level. 100% indicates that clipping does not take place.

Remote-control command:

SOUR:BB:C2K:CLIP:LEV 50

**Clipping Mode - CDMA2000** Selects the clipping method. A graphic illustration of the way in which these two methods work is given in the menu.

**Vector  $|i + q|$**  The limit is related to the amplitude  $|i + q|$ . The I and Q components are mapped together, the angle is retained (see also figures above, Clipping State).

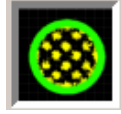

Remote-control command:

SOUR:BB:C2K:CLIP:MODE VECT

**Scalar  $|i| + |q|$**  The limit is related to the absolute maximum of all the I and Q values  $|i| + |q|$ .

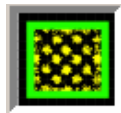

The I and Q components are mapped separately, the angle changes.

Remote-control command:

SOUR:BB:C2K:CLIP:MODE SCAL

### Sequence Length ARB - CDMA2000

Changes the sequence length of the arbitrary waveform component of the CDMA signal in the number of frames. This component is calculated in advance and output in the arbitrary waveform generator. It is added to the realtime signal components.

The number of chips is determined from this sequence length (1 Frame = 80 ms) and the chip rate. At 1.2288 MChips/s a frame equals 98.304 chips.

In pure amplifier tests with several channels and no real time channels, it is possible to improve the statistical properties of the signal by increasing the sequence length.

---

**Note:**

*Unlike with 3GPP, in the case of cdma2000 the length of a frame is not uniformly defined. A frame length of 80 ms is used in the R&S Vector Signal Generator. This is the same frame length that the Winlqsim software uses for cdma2000 frames. Division into 80 ms frames was chosen because in this time grid the frame lengths for both the SYNC channel, with its cycle duration of 26.67 ms, and all other channels work out to 5 ms, 10 ms, 20 ms or 80 ms.*

*The F-BCH has a frame length of 160 ms. In order to use this channel, an even number of 80 ms frames has to be set.*

---

Remote-control command:

SOUR:BB:C2K:SLEN 20

**Invert Q for Correct  
Baseband Output -  
CDMA2000**

Inverts Q-part of the baseband signal. (see also Section "[I/Q Modulator](#)", Page 4.541)

**ON**

The signal on the baseband outputs meets the cdma2000 standard. In order to generate an RF signal that conforms to the standard, the **I/Q Swap** function in the **I/Q Modulator** menu must be enabled (**On**).

Remote-control command

SOUR:BB:C2K:IQSW:STAT ON

**OFF**

The signal on the baseband outputs does not meet the cdma2000 standard. It can however be mixed with other signals from the second baseband without any problem. In order to generate the RF signal, the **I/Q Swap** function in the **I/Q Modulator** menu must be disabled (**Off**).

Remote-control command:

SOUR:BB:C2K:IQSW:STAT OFF

# Trigger-Marker-Clock - CDMA2000

The **Trigger/Marker/Clock** menu can be reached via the **CDMA2000** main menu.

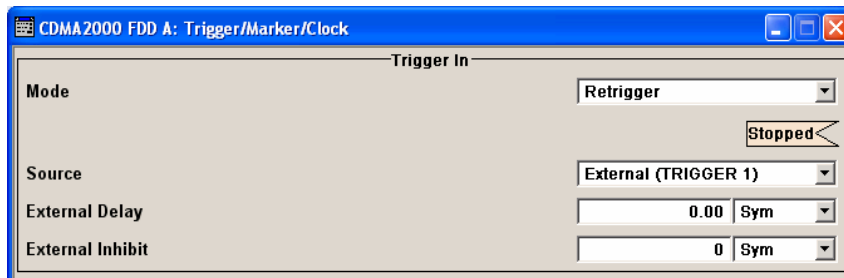

The **Trigger In** section is where the trigger for the CDMA2000 signal is set. Various parameters will be provided for the settings, depending on which trigger source - internal or external - is selected. The current status of signal generation (**Running** or **Stopped**) is indicated for all trigger modes.

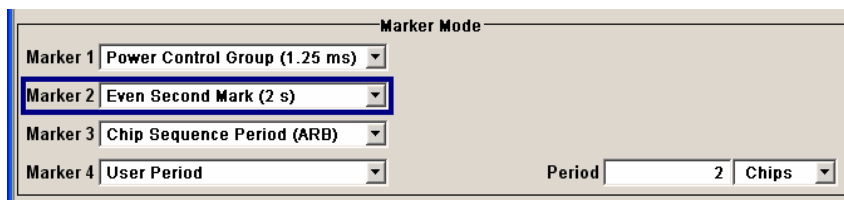

The **Marker Mode** section is where the marker signals at the MARKER output connectors are configured.

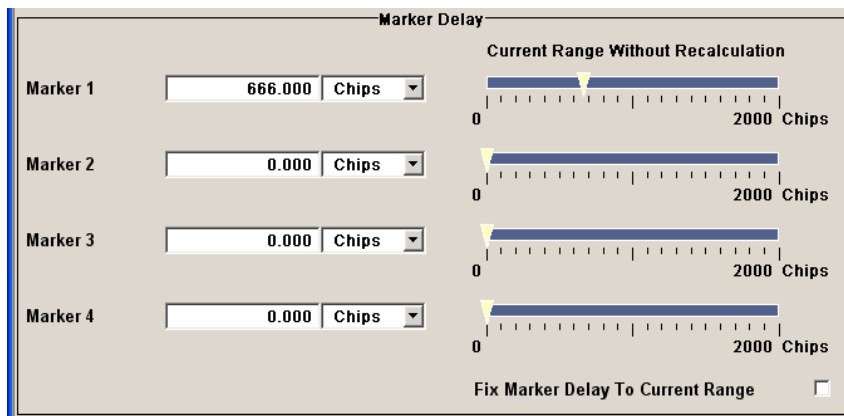

The **Marker Delay** section is where a marker signal delay can be defined, either without restriction or restricted to the dynamic section, i.e., the section in which it is possible to make settings without restarting signal and marker generation.

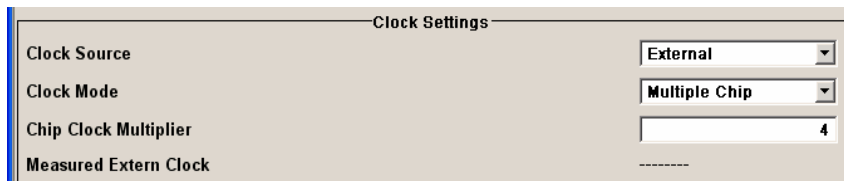

The **Clock Settings** section is where the clock source is selected and - in the case of an external source - the clock type.



The **Global Trigger/Clock Settings** button leads to a submenu for general trigger and clock settings.

The **UserMarker/AUX I/O** menu leads to a submenu for mapping configurations.

<b>Trigger Mode - CDMA2000</b>	Selects trigger mode. The trigger mode determines the effect of a trigger on the signal generation.
<b>Auto</b>	The CDMA2000 signal is generated continuously. Remote-control command: SOUR:BB:C2K:SEQ AUTO
<b>Retrigger</b>	The CDMA2000 signal is generated continuously. A trigger event (internal or external) causes a restart. Remote-control command: SOUR:BB:C2K:SEQ RETR
<b>Armed_Auto</b>	The CDMA2000-Signal signal is generated only when a trigger event occurs. Then the signal is generated continuously. Button <b>Arm</b> stops signal generation. A subsequent trigger event (internal with <b>Execute Trigger</b> or external) causes a restart. Remote-control command: SOUR:BB:C2K:SEQ AAUT
<b>Armed_Retrigge</b>	The CDMA2000-Signal signal is generated only when a trigger event occurs. Then the signal is generated continuously. Every subsequent trigger event causes a restart. Button <b>Arm</b> stops signal generation. A subsequent trigger event (internal with <b>Execute Trigger</b> or external) causes a restart. Remote-control command: SOUR:BB:C2K:SEQ ARET
<b>Single</b>	The CDMA2000 signal is generated only when a trigger event occurs. Then the signal is generated once to the length specified at <b>Signal Duration</b> . Every subsequent trigger event (internal with <b>Execute Trigger</b> or external) causes a restart. Remote-control command: SOUR:BB:C2K:SEQ SING

**Signal Duration Unit -  
CDMA2000**

Defines the unit for the entry of the length of the signal sequence to be output in the **Single** trigger mode. Available units are chip sequence length (CLS), chips or frames.

Remote-control commands:

SOUR:BB:C2K:TRIG:SLUN CHIP

**Signal Duration -  
CDMA2000**

Defines the length of the signal sequence to be output in the **Single** trigger mode. The unit of the entry is defined under **Signal Duration Unit**. It is possible to output deliberately just part of the frame, an exact sequence of the frame, or a defined number of repetitions of the frame.

Remote-control commands:

SOUR:BB:C2K:TRIG:SLEN 2000

**Running - Stopped -  
CDMA2000**

Displays the status of signal generation for all trigger modes. This display appears only when CDMA2000 is enabled (**State On**).

Remote-control command:

SOUR:BB:C2K:TRIG:RMOD?

Response: RUN

**Running**

The CDMA2000 modulation signal is generated; a trigger was (internally or externally) initiated in triggered mode.

If **Armed\_Auto** and **Armed\_Retrigger** have been selected, generation of signals can be stopped with the **Arm** button. A new trigger (internally with **Execute Trigger** or externally) causes a restart.

**Stopped**

The signal is not generated, and the instrument waits for a trigger event (internal or external).

**Arm - CDMA2000**

Stops signal generation. This button appears only with **Running** signal generation in the **Armed\_Auto** and **Armed\_Retrigger** trigger modes.

Signal generation can be restarted by a new trigger (internally with **Execute Trigger** or externally).

Remote-control command:

SOUR:BB:C2K:TRIG:ARM:EXEC

**Execute Trigger -  
CDMA2000**

Executes trigger manually. A manual trigger can be executed only when an internal trigger source and a trigger mode other than Auto have been selected.

Remote-control commands:

SOUR:BB:C2K:TRIG:SOUR INT

SOUR:BB:C2K:SEQ RETR

SOUR:BB:C2K:TRIG:EXEC

**Trigger Source -  
CDMA2000**

Selects trigger source. This setting is effective only when a trigger mode other than Auto has been selected.

**Internal**

The trigger event is executed by **Execute Trigger**.

Remote-control command:

SOUR:BB:C2K:TRIG:SOUR INT

**Internal  
(Baseband A/B)**

The trigger event is executed by the trigger signal from the second path (two-path instruments only).

Remote-control command:

SOUR:BB:C2K:TRIG:SOUR OBAS

**External  
(TRIGGER 1 / 2)**

The trigger event is executed with the aid of the active edge of an external trigger signal. The trigger signal is supplied via the TRIGGER 1 or TRIGGER 2 connector.

The polarity, the trigger threshold and the input impedance of the TRIGGER input can be set in the **Global Trigger/Clock Settings** menu.

Remote-control command:

SOUR:BB:C2K:TRIG:SOUR EXT | BEXT

**Trigger Delay - CDMA2000**

Sets trigger signal delay in chips on external triggering or on internal triggering via the second path.

This enables the R&S Vector Signal Generator to be synchronized with the device under test or other external devices.

**Note:**

*The delay can be set separately for each of the two paths.*

Remote-control command: :

SOUR:BB:C2K:TRIG:EXT:DEL 3

SOUR:BB:C2K:TRIG:OBAS:DEL 3

**Trigger Inhibit - CDMA2000** Sets the duration for inhibiting a new trigger event subsequent to triggering. The input is to be expressed in chips.

In the **Retrigger** mode every trigger signal causes signal generation to restart. This restart is inhibited for the specified number of samples.

This parameter is only available on external triggering or on internal triggering via the second path.

**Note:**

*The trigger inhibit can be set separately for each of the two paths.*

Remote-control command:

```
SOUR:BB:C2K:TRIG:EXT:INH 1000
SOUR:BB:C2K:TRIG:OBAS:INH 1000
```

**Marker Mode - CDMA2000** Selects a marker signal for the associated MARKER output.

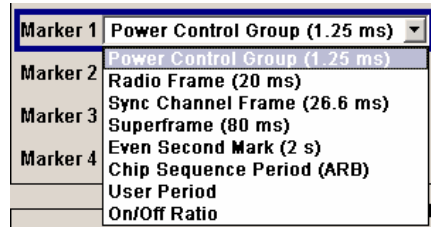

**Power Control Group (1.25 ms)** A marker signal is generated at the start of each Power Control Group (every 1,25 ms).

Remote-control command:

```
SOUR:BB:C2K:TRIG:OUTP1:MODE PCGR
```

**Radio Frame (20 ms)** A marker signal is generated every 20 ms (traffic channel frame clock).

Remote-control command:

```
SOUR:BB:C2K:TRIG:OUTP1:MODE RFR
```

**Sync Channel Frame (26.6 ms)** A marker signal is generated at the beginning of each Sync Channel Frame (every 26,6 ms).

Remote-control command:

```
SOUR:BB:C2K:TRIG:OUTP1:MODE SCFR
```

**Superframe (80 ms)** A marker signal is generated every 80 ms (super frame clock).

Remote-control command:

```
SOUR:BB:C2K:TRIG:OUTP1:MODE SFR
```



**Even Second Mark (2 s)** A marker signal is generated every 2 seconds.  
 Remote-control command:  
 SOUR:BB:C2K:TRIG:OUTP1:MODE ESEC

**Chip Sequence Period (ARB)** A marker signal is generated at the beginning of every Arbitrary Waveform sequence (depending on the set sequence length). The marker signal is generated regardless of whether or not an ARB component is actually used.  
 Remote-control command:  
 SOUR:BB:C2K:TRIG:OUTP1:MODE CSP

**Ratio** A regular marker signal that is defined by an ON/OFF ratio is generated. A period lasts one ON and OFF cycle.

Start of signal

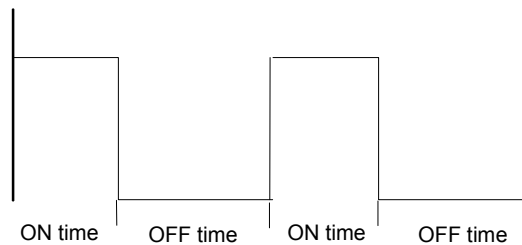

The ON time and OFF time are each expressed as a number of chips and are set in an input field which opens when **ON/OFF ratio** is selected.

On Time	<input type="text" value="1"/>	Chips
Off Time	<input type="text" value="1"/>	Chips

Remote-control commands:  
 SOUR:BB:C2K:TRIG:OUTP1:MODE RAT  
 SOUR:BB:C2K:TRIG:OUTP1:OFFT 200  
 SOUR:BB:C2K:TRIG:OUTP1:ONT 200

**User Period** A marker signal is generated at the beginning of every user-defined period. The period is defined in **Period**.

Period	<input type="text" value="2"/>	Chips
--------	--------------------------------	-------

Remote-control command:  
 SOUR:BB:C2K:TRIG:OUTP1:MODE USER  
 SOUR:BB:C2K:TRIG:OUTP1:PER 614400

**Marker x Delay -  
CDMA2000**

Enters the delay between the marker signal at the marker outputs and the start of the signal.

The input is expressed as a number of chips.

If the setting "**Fix marker delay to dynamic range**" is enabled, the setting range is restricted to the dynamic range. In this range the delay of the marker signals can be set without restarting the marker and signal.

Remote-control command:

SOUR:BB:C2K:TRIG:OUTP2:DEL 2

**Current Range without  
Calculation- CDMA2000**

Displays the dynamic range within which the delay of the marker signals can be set without restarting the marker and signal.

Remote-control command

SOUR:BB:C2K:TRIG:OUTP2:DEL:MAX?

SOUR:BB:C2K:TRIG:OUTP2:DEL:MIN?

**Fix marker to dynamic  
range - CDMA2000**

Restricts the marker delay setting range to the dynamic range. In this range the delay can be set without restarting the marker and signal.

Remote-control command:

SOUR:BB:C2K:TRIG:OUTP:DEL:FIX ON

**Clock Source - CDMA2000**

Selects the clock source.

**Intern**

The internal clock reference is used to generate the chip clock.

Remote-control command:

SOUR:BB:C2K:CLOC:SOUR INT

**Extern**

The external clock reference is fed in as the chip clock or multiple thereof via the CLOCK connector.

The chip rate must be correctly set to an accuracy of  $\pm 2\%$  (see data sheet).

The polarity of the clock input can be changed with the aid of **Global Trigger/Clock Settings**. In the case of two-path instruments this selection applies to path A.

Remote-control command:

SOUR:BB:C2K:CLOC:SOUR EXT

<b>Clock Mode - CDMA2000</b>	Enters the type of externally supplied clock.
<b>Chip</b>	<p>A chip clock is supplied via the CLOCK connector.</p> <p>Remote-control command: SOUR:BB:C2K:CLOC:MODE CHIP</p>
<b>Multiple</b>	<p>A multiple of the chip clock is supplied via the CLOCK connector; the chip clock is derived internally from this.</p> <p>The <b>Multiplier</b> window provided allows the multiplication factor to be entered.</p> <p>Remote-control command: SOUR:C2K:CLOC:MODE MCH</p>
<b>Chip Clock Multiplier - CDMA2000</b>	<p>Enters the multiplication factor for clock type <b>Multiple</b>.</p> <p>Remote-control command: SOUR:BB:C2K:CLOC:MULT 4</p>
<b>Measured External Clock - CDMA2000</b>	<p>Displays the measured frequency of the external clock signal. This enables the user to permanently monitor the frequency of the externally introduced clock.</p> <p>This information is displayed only if the external clock source has been selected.</p> <p>Remote-control command: :CLOC:INP:FREQ?</p>
<b>Global Trigger/Clock Settings - CDMA2000</b>	<p>Calls the <b>Global Trigger/Clock/Input Settings</b> menu. This menu is used among other things for setting the trigger threshold, the input impedance and the polarity of the trigger inputs TRIGGER 1/2.</p> <p>In the case of two-path instruments these settings are valid for both paths. The parameters in this menu affect all digital modulations and standards, and are described in the section "<a href="#">Global Trigger/Clock/Input Settings – Setup -Environment</a>".</p>
<b>User Marker/AUX I/O Settings – CDMA2000</b>	<p>Calls the <b>UserMarker/AUX I/O</b> menu. This menu is used for mapping configuration. The parameters in this menu affect all digital modulations and standards, and are described in the section "<a href="#">Global Trigger/Clock/Input Settings – Setup -Environment</a>".</p>

## Predefined Settings - Downlink - CDMA2000

The **Predefined Settings** can be reached via the **CDMA2000** main menu. It is only available when the Downlink transmission direction is selected. The channel table of base station 1 is filled (preset) with the set parameters.

With the **Predefined Settings** function, it is possible to create highly complex scenarios with just a few keystrokes. This function is of use if, say, just the envelope of the signal is of interest.

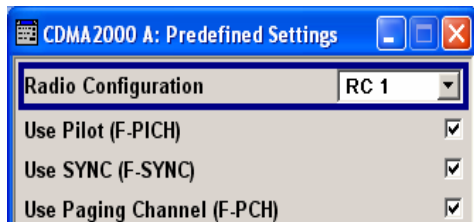

In the top section of the menu, the radio configuration of the test scenario and the used special channels are selected.

A separate set of settings of all predefined parameters is provided for each radio configuration. If the radio configuration is changed, the set of traffic channel settings belonging to this RC is automatically indicated.

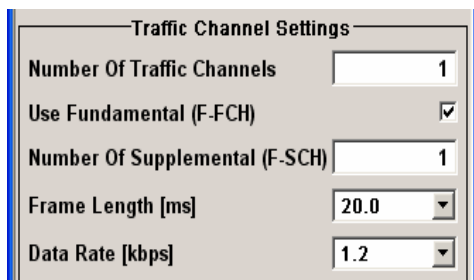

In the **Traffic Channel Settings** section, the number and the structure of the traffic channels used in the test scenario is set. The selected structure is valid for all activated traffic channels.

The indicated parameters depend on the radio configuration. Their settings are specific for the selected radio configuration.

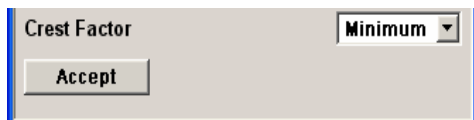

In the bottom section of the menu, the desired range for the crest factor is selected. Button **Accept** presets the channel table of base station 1 with the predefined parameters.

In the top section of the menu, the radio configuration of the test scenario and the used special channels are selected.

### Radio Configuration - Predefined Settings - CDMA2000

Selects the radio configuration (RC).

The R&S Vector Signal Generator provides a separate set of settings of all predefined traffic channel parameters for each radio configuration. If the radio configuration is changed, the set of traffic channel table values belonging to this RC is automatically activated.

Remote-control command:

```
SOUR:BB:C2K:PPAR:RCON 1
```

### Use Pilot (F-PICH) - Predefined Settings - CDMA2000

Selects if pilot channel F-PICH is used in the scenario or not.

Remote-control command:

```
SOUR:BB:C2K:PPAR:PICH ON
```

**Use Sync (F-Sync) -  
Predefined Settings -  
CDMA2000**      Selects if sync channel F-SYNC is used in the scenario or not.  
Remote-control command:  
SOUR:BB:C2K:PPAR:SCH ON

**Use Paging Channel (F-  
PCH) - Predefined Settings  
- CDMA2000**      Selects if paging channel F-PCH is used in the scenario or not.  
Remote-control command:  
SOUR:BB:C2K:PPAR:PCH ON

In the **Traffic Channel Settings** section, the number and the structure of the traffic channels used in the test scenario is set. The selected structure is valid for all activated traffic channels.

**Number of Traffic Channels  
- Predefined Settings -  
CDMA2000**      Sets the number of activated traffic channels. Channels F-DCCH, F-FCH, and F-SCH form a traffic channel.  
Remote-control command:  
SOUR:BB:C2K:PPAR:TCH:COUN 6

**Use Dedicated Control (F-  
DCCH) - Predefined  
Settings - CDMA2000**      Selects if the dedicated control channel F-DCCH is activated for the traffic channel or not. PN9 is used as data source for F-DCCH.  
The set state is specific for the selected radio configuration.  
F-DCCH cannot be activated for radio configuration RC1 and RC2.  
Remote-control command:  
SOUR:BB:C2K:PPAR:TCH:DCCH ON

**Use Fundamental (F-FCH) -  
Predefined Settings -  
CDMA2000**      Selects if the fundamental channel F-FCH is activated for the traffic channel or not. PN9 is used as data source for F-FCH. The set value is specific for the selected radio configuration.  
Remote-control command:  
SOUR:BB:C2K:PPAR:TCH:FCH ON

**Number of Supplemental  
(F-SCH) - Predefined  
Settings - CDMA2000**      Sets the number of activated supplemental channels F-SCH. PN9 is used as data source for F-SCH. The set value is specific for the selected radio configuration.  
The maximum number depends on the selected radio configuration:  
RC1 and RC2: 0 ... 7  
RC3, RC4, and RC5: 0 ... 2  
Remote-control command:  
SOUR:BB:C2K:PPAR:TCH:SCH:COUN 3

**Frame Length - Predefined Settings - CDMA2000** Sets the frame length of the traffic channel. The set value is specific for the selected radio configuration.

The value range for the frame length depends on the selected radio configuration:

RC1 and RC2: 20 ms

RC3 to RC5: 5, 20, 40 and 80 ms

Remote-control command:

SOUR:BB:C2K:PPAR:TCH:FLEN 20ms

**Data Rate - Predefined Settings - CDMA2000** Sets the data rate for F-FCH and all F-SCH. The set value is specific for the selected radio configuration.

The value range depends on the set frame length.

Remote-control command:

SOUR:BB:C2K:PPAR:TCH:DATA:RATE D7K5

In the bottom section of the menu, the desired range for the crest factor is selected. Button **Accept** presets the channel table of base station 1 with the predefined parameters.

**Crest Factor - Predefined Settings - CDMA2000** Selects desired range for the crest factor of the test scenario. The crest factor of the signal is kept in the desired range by automatically setting appropriate Walsh Code Numbers.

**Minimum** The crest factor is minimized by assigning Walsh codes which are chosen as close as possible.

Remote-control command:

SOUR:BB:C2K:PPAR:CRES MIN

**Average** An average crest factor is set. The Walsh codes are distributed uniformly over the code domain.

Remote-control command:

SOUR:BB:C2K:PPAR:CRES AVER

**Worst** The crest factor is set to an unfavorable value (i.e. maximum) by assigning Walsh codes which are separated as widely as possible.

Remote-control command:

SOUR:BB:C2K:PPAR:CRES WORS

**Accept - Predefined Settings - CDMA2000** Presets the channel table of base station 1 with the parameters defined in the **Predefined Settings** menu. Base station one is switched on, the other base stations are switched off.

Remote-control command:

SOUR:BB:C2K:PPAR:EXEC

## Additional Mobile Station - Uplink - CDMA2000

Submenu **Additional User Equipment** can be reached via the **CDMA2000** main menu. It is only available when the Uplink transmission direction is selected.

The menu makes it possible to simulate up to 64 additional mobile stations and thus to generate a signal that corresponds to the received signal for a base station with high capacity utilization.

The fourth mobile station (MS4) serves as a template for all other stations. The following parameters are the only ones modified for the additional mobile stations:

- LC Mask Step (different for all stations)
- Power (different to MS4, but identical among themselves)

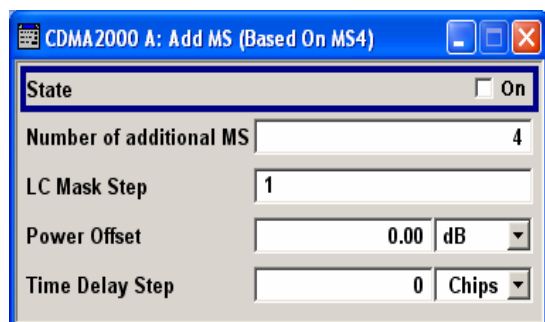

### State - Additional MS - CDMA2000

Activates additional mobile stations. At **State Off**, all the additional mobile stations are switched off.

Remote-control command:

```
SOUR:BB:C2K:MST:ADD:STAT ON
```

### Number of Additional MS - CDMA2000

Sets the number of additional mobile stations. As many as 64 additional mobile stations can be simulated.

Remote-control command:

```
SOUR:BB:C2K:MST:ADD:COUN 64
```

### LC Mask Step - Additional MS - CDMA2000

Enters the step width for increasing the LC mask of the additional mobile stations. The start value is the scrambling code of MS4.

The Long Code generator mask serves for channel-specific and user-specific scrambling of the code channel.

Remote-control command:

```
SOUR:BB:C2K:MST:ADD:LCM:STEP 5
```

**Power Offset - Additional MS - CDMA2000**

Sets the power offset of the active channels of the additional mobile stations to the power outputs of the active channels of MS4.

The resultant power must fall within the range 0 ... - 80 dB. If the value is above or below this range, it is limited automatically.

Remote-control command:

```
SOUR:BB:C2K:MST:ADD:POW:OFFS -3
```

**Time Delay Step - Additional MS - CDMA2000**

Enters the step width for the time delay of the additional mobile stations to one another. The start value returns the time delay of MS4. Entry is made in chips and can be a maximum of 1 frame.

The time delay allows mobile stations to be simulated even if the arrival of their signals is not synchronized at the base station.

Remote-control command:

```
SOUR:BB:C2K:MST:ADD:TDEL:STEP 256
```



## Base Station Configuration - CDMA2000

The **Base Station Configuration** menu is called by selecting base station **BS1** ... **BS4** in the **CDMA2000** menu. Base stations can be configured independently of one another. Base station 1 (BS1) also includes real time channels.

The menu comprises the **Common Settings** section, in which the general parameters of the base station are set, a row containing the buttons **Code Domain...** and **Channel Graph...**, which call the appropriate graphics and the most important part, the channel table.

	Channel Type	Real Time	RC	Frame Length [ms]	Data Rate [kbps]	Walsh	Q. Orth.	Power [dB]	Data	Dlist Pattern	More Params	State	Dom Conf
0-1	F-PICH			20.0	NotUsd	0		-7.00	All 0		Config..	On	
0-2	F-TDPICH			20.0	NotUsd	16		0.00	All 0		Config..	Off	
0-3	F-APICH			20.0	NotUsd	0		0.00	All 0		Config..	Off	
0-4	F-ATDPICH			20.0	NotUsd	0		0.00	All 0		Config..	Off	
0-5	F-SYNC	Off		26.6	1.2	32		-12.72	PN 9		Config..	On	
0-6	F-PCH			20.0	9.6	1		-6.72	PN 9		Config..	On	
0-7	F-BCH			40.0	19.2	0		0.00	PN 9		Config..	Off	
0-8	F-QPCH			20.0	4.8	0		0.00	PN 9		Config..	Off	
0-9	F-CPCCH			20.0	19.2	0		0.00	PN 9		Config..	Off	
0-10	F-CACH			5.0	9.6	0		0.00	PN 9		Config..	Off	
0-11	F-CCCH			20.0	9.6	0		0.00	PN 9		Config..	Off	
0-12	F-PDCCH		10			0		0.00	PN 9		Config..	Off	
0-13	F-PDCCH		10			0		0.00	PN 9		Config..	Off	
0-14	F-PDCH		10					0.00	PN 9		Config..	Off	
1-1	F-FCH	Off	3	20.0	9.6	8	Off	-12.72	PN 9		Config..	On	
1-2	F-SCH1	Off	3	20.0	19.2	17	Off	-9.72	PN 9		Config..	On	
1-3	F-SCH2	Off	3	20.0	19.2	18	Off	-9.72	PN 9		Config..	On	
1-4	F-DCCH	Off	3	20.0	9.6	0	Off	0.00	PN 9		Config..	Off	
2-1	F-FCH		3	20.0	9.6	9	Off	-12.72	PN 9		Config..	On	
2-2	F-SCH1		3	20.0	19.2	19	Off	-9.72	PN 9		Config..	On	

**State - BS - CDMA2000**

Activates or deactivates the selected base station.

Remote-control command:

```
SOUR:BB:C2K:BST1:STAT ON
```

**Transmit Diversity - BS -  
CDMA2000**

Switches transmit diversity on and off.

The signal can be sent simultaneously on several antennas. Various forms of transmit diversity are described in the CDMA2000 standard. Different coding is used to divide the signal between the two antennas. As a result, the receiver can decode the traffic signal from the two input signals and is less liable to fading and other interference. The R&S Vector Signal Generator can simulate the signal of one of the two antennas.

To activate transmit diversity, the antennas whose signals are to be simulated must be specified. The signal is generated differently depending on the selected antenna

Two diversity schemes for the calculation of the signals are available for selection at **Diversity Mode**.

**Off**

No transmit diversity

Remote-control command:

SOUR:BB:C2K:BST1:TDIV OFF

**Antenna 1**

Calculate and apply the output signal for antenna 1. The diversity scheme is selected at **Diversity Mode**.

Remote-control command:

SOUR:BB:C2K:BST1:TDIV ANT1

**Antenna 2**

Calculate and apply the output signal for antenna 2. The diversity scheme is selected at **Diversity Mode**.

Remote-control command:

SOUR:BB:C2K:BST1:TDIV ANT2

**Diversity Mode - BS -  
CDMA2000**

Selects the diversity scheme for **Transmit Diversity**.

The diversity scheme defines the calculation mode of the signal for the selected antenna (at Transmit Diversity).

**OTD**

Orthogonal Transmit Diversity Mode. A forward link transmission method which distributes forward link channel symbols among multiple antennas and spreads the symbols with a unique Walsh or quasi-orthogonal function associated with each antenna.

Remote-control command:

SOUR:BB:C2K:BST1:TDIV:MODE OTD

**STS** Space Time Spreading Mode. A forward link transmission method which transmits all forward link channel symbols on multiple antennas and spreads the symbols with complementary Walsh or quasi-orthogonal functions.

Remote-control command:  
 SOUR:BB:C2K:BST1:TDIV:MODE STS

**Time Delay- BS - CDMA2000** Enters the time delay of the signal of the selected base station compared to the signal of base station 1.

Remote-control command:  
 SOUR:BB:C2K:BST2:TDEL 256

**PN Offset - BS - CDMA2000** Enters the PN offset (short code).

The PN offset determines the start phase of these PN short-code sequences (see "[PN Short-Code Scrambling - Downlink](#)", Page 4.538").

This permits signals of different base stations to be distinguished.

Remote-control command:  
 SOUR:BB:C2K:BST3:PNOF 4

**Quasi orth Walsh Set - BS - CDMA2000** Selects the Quasi Orthogonalen Walsh Set. The standard defines three different sets.

The so-called 'quasi-orthogonal Walsh sets' can be used in addition to the Walsh codes. They increase the number of possible channels and thus extend the base-station capacity. When the quasi-orthogonal Walsh code is used, spreading the data stream results in complex spreading also through an additional rotation of the output phase (the spreading code then consists of a real and an imaginary part).

In the channel table, a decision can be made for each channel whether the Walsh code of the standard set or of the quasi-orthogonal set should be used. The quasi-orthogonal Walsh codes are used if **On** is activated in column **Q. Orth**.

Remote-control command:  
 SOUR:BB:C2K:BST1:QWS 2

The button **Code Domain ...** above the channel table calls a graphical display of the assigned code domain.

**Code Domain Graph - BS - CDMA2000** Opens the code domain display to visually check the signal

Remote-control command: n.a.

The Walsh codes of variable length used by CDMA2000 are the so-called Hadamard codes.

The structure of these codes is explained below. The code matrix of the order N+1 is obtained from the matrix N by extending the latter to the right and downwards through copying and downwards to the right by copying and inversion.

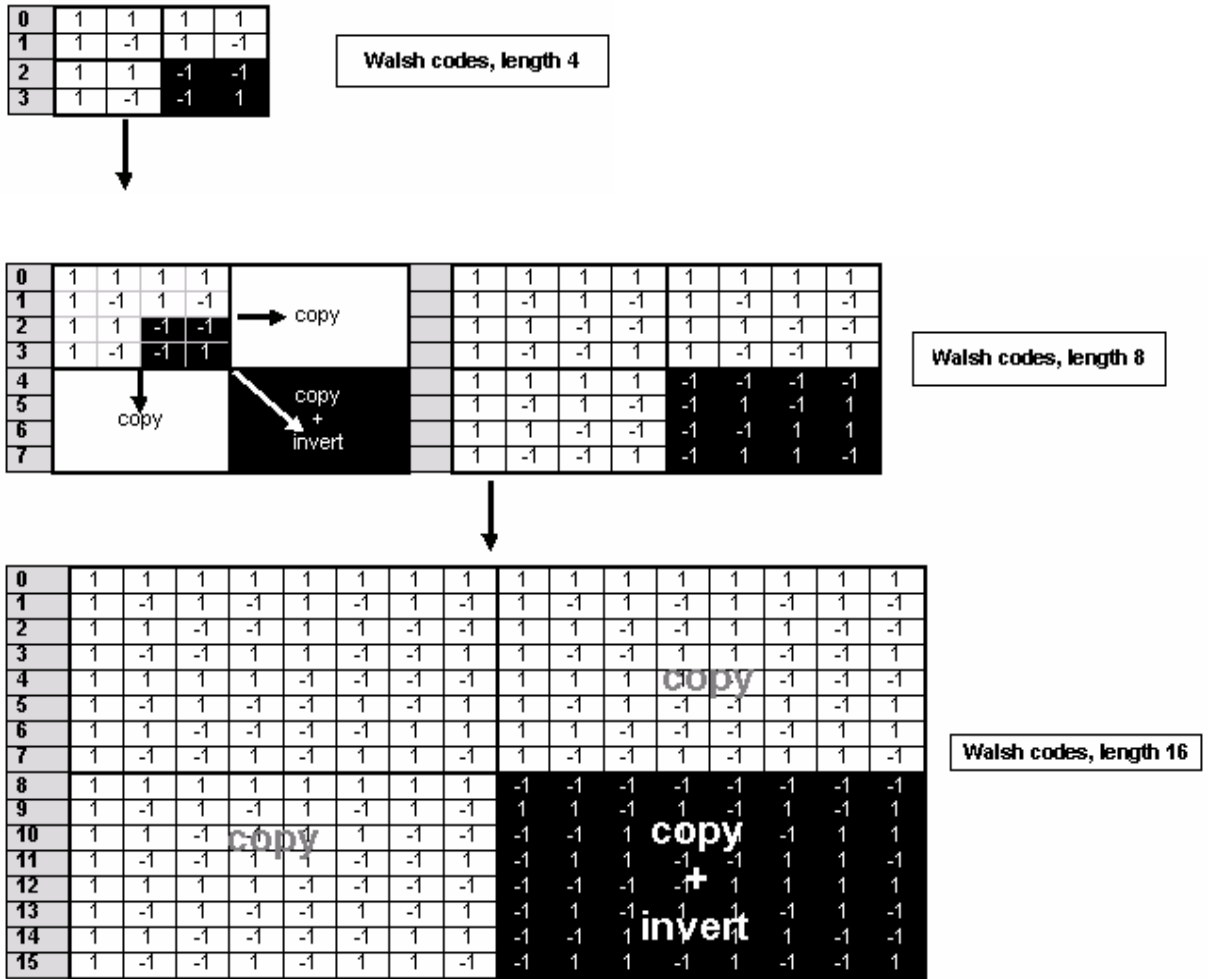

Fig. 4-52 Generation scheme of Walsh code

Walsh codes of the lengths 4, 8, 16, 32, 64, and 128 are used in CDMA2000 with spreading rate 1. The greater the spreading factor / Walsh code length, the smaller the useful symbol rate prior to spreading and vice versa.

In contrast to the spreading codes of 3GPP, Walsh codes of short lengths (low spreading factor) do not occupy a block area in a Walsh matrix of larger spreading factor. Several lines (ratio of the two spreading factors) are occupied in the matrix with a higher spreading factor, distributed over the whole matrix. This behavior is illustrated in the diagram below. This results from the structuring scheme of the Walsh codes that are obtained by copying and inverting the next smaller matrix.

#	Walsh length 4	Walsh length 8	Walsh length 16
0	1 1 1 1	1 1 1 1 1 1 1 1	1 1 1 1 1 1 1 1 1 1 1 1 1 1 1 1
1	1 -1 1 -1	1 -1 1 -1 1 -1 1 -1	1 -1 1 -1 1 -1 1 -1 1 -1 1 -1 1 -1 1 -1
2	1 1 -1 -1	1 1 -1 -1 1 1 -1 -1	1 1 -1 -1 1 1 -1 -1 1 1 -1 -1 1 1 -1 -1
3	1 -1 -1 1	1 -1 -1 1 1 -1 -1 1	1 -1 -1 1 1 -1 -1 1 1 -1 -1 1 1 -1 -1 1
4		1 1 1 1 -1 -1 -1 -1	1 1 1 1 -1 -1 -1 -1 1 1 1 1 -1 -1 -1 -1
5		1 -1 1 -1 -1 1 -1 1	1 -1 1 -1 -1 1 -1 1 1 -1 1 -1 -1 1 -1 1
6		1 1 -1 -1 -1 -1 1 1	1 1 -1 -1 -1 -1 1 1 1 1 -1 -1 -1 -1 1 1
7		1 -1 -1 1 -1 1 1 -1	1 -1 -1 1 -1 1 1 -1 1 -1 -1 1 -1 1 1 -1
8			1 1 1 1 1 1 1 1 -1 -1 -1 -1 -1 -1 -1 -1
9			1 -1 1 -1 1 -1 1 -1 -1 -1 1 1 -1 -1 1 1
10			1 1 -1 -1 1 1 -1 -1 -1 -1 1 1 -1 -1 1 1
11			1 -1 -1 1 1 -1 -1 1 -1 -1 1 1 -1 -1 1 1
12			1 1 1 1 -1 -1 -1 -1 -1 -1 1 1 -1 -1 1 1
13			1 -1 1 -1 -1 1 -1 1 -1 -1 1 1 -1 -1 1 1
14			1 1 -1 -1 -1 -1 1 1 -1 -1 1 1 -1 -1 1 1
15			1 -1 -1 1 -1 1 1 -1 -1 -1 1 1 -1 -1 1 1

Fig. 4-53 Walsh code tree

If a Walsh code with the length 4 and index 1 is used, codes 1 and 5 are disabled at the length 8, and codes 1, 5, 9 and 13 at the length 16 because codes of greater length contain the output code of shorter length (or its inversion).

When using such conflicting Walsh codes simultaneously, the signals of the associated code channels are mixed so that they can no longer be separated in the receiver. Orthogonality will then be lost.

The matrix range with the highest spreading factor (i.e. 128), which is based on the spreading code selected in the code tree, is then defined as **domain** of a specific Walsh spreading code. Using a spreading code means that its entire domain is used.

The **Code Domain** graphic shows the assignment of active code channels in the code domain. The upper part shows the code domain of the standard Walsh set, the lower part the code domain of quasi-orthogonal Walsh sets.

The code numbers are plotted on the X axes, the colored bars show the code channels. The legend at the left of the graph indicates the assignment of colors to the spreading factors. An additional color is reserved for the packet channel F-PDCH because this channel may be assigned to more than one code channel. The height of the bars indicates the power of the code channel.

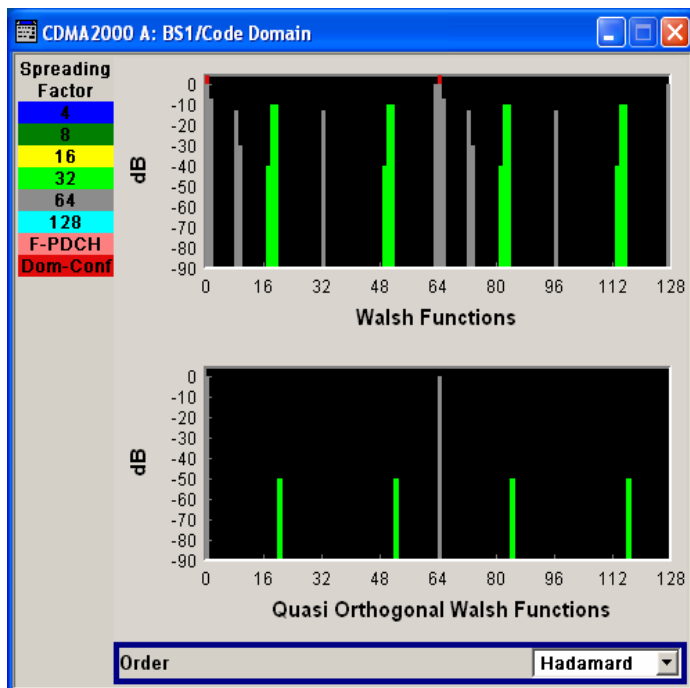

In this display assignment of the domains can be seen at a glance. Compared to 3GPP it is however much more difficult to see whether the code domains of different channels overlap, i.e. whether there is a domain conflict. This is due to the structure of the Walsh codes described above. The reason is that no block areas are occupied in the domain but several areas of minimum width are distributed over the whole domain.

Therefore, the occurrence of a domain conflict is indicated by a red dot marking the involved channels. In addition, in the channel table, a code domain conflict with an is indicated in column **Do Conf** on the far right of the graph by a red dot and the orange-colored column.

	Channel Type	Real Time	RC	Frame Length [ms]	Data Rate [kbps]	Walsh	Q. Orth.	Power [dB]	Data	Dlist Pattern	More Params	State	Dom Conf
14	F-PDCH		10					0.00	PN 9		Config..	Off	
31	F-FCH	Off	4	20.0	9.6	0	Off	0.00	PN 9		Config..	Off	
32	F-SCH31	Off	4	20.0	9.6	0	On	0.00	PN 9		Config..	On	●
33	F-SCH32	Off	4	20.0	9.6	1	Off	0.00	PN 9		Config..	On	●
34	F-DCCH	Off	4	20.0	9.6	2	Off	0.00	PN 9		Config..	On	
41	F-FCH		5	20.0	14.4	3	Off	0.00	PN 9		Config..	On	●

**Note:**

The graph is calculated from the settings that have been made. A change in the settings results at once in a change of the graphical display.

**Order - Code Domain BS - CDMA2000** Switches the order of the spreading codes.

**Hadamard**

The code channels are displayed in the order determined by the Hadamard matrix. The codes are numbered as Walsh codes according to the standard.

Remote-control command:

```
SOUR:BB:C2K:BST1:DCON:MODE HAD
```

**Bit reversed**

The code channels are displayed in the order defined by the Orthogonal Variable Spreading Factor (OVSF) code tree (3GPP code).

The Walsh codes and their generation scheme are closely related to the spreading codes of 3GPP. Basically, the same spreading sequences are used, only the order in the respective code trees is different.

According to 3GPP TS 25.213 the following code tree is used:

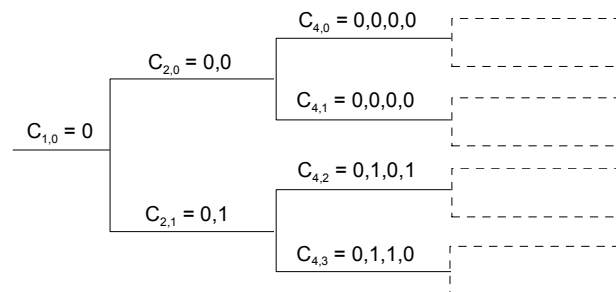

To find a 3GPP code that corresponds to a CDMA2000 code, the bit-inverted line (line index) has to be selected in the 3GPP matrix of identical spreading factor.

**Example:**

The 3GPP spreading code matching line 10 of the 16-bit Walsh code matrix is searched for. The binary form of the line index 10 (with 4 bits, because of Walsh length  $16 = 2^4$ ) is 1010. The bit-inverted index is 0101, i.e. 5 in decimal notation. This means that the Walsh code No. 10 with the length 16 corresponds to the 3GPP spreading code 5 of the same length (spreading factor).

Remote-control command:

```
SOUR:BB:C2K:BST1:DCON:MODE BREV
```

The button **Channel Graph..** above the channel table calls a graphical display of the activated channels.

**Channel Graph - Base Station - CDMA2000**

Opens the channel graph display to visually check the configured signal.

Remote-control command: n.a.

The channel graph display shows the active code channels. The channel number is plotted on the X axis. The red bars represent the special channels, the green bars the traffic channels. The channel index is plotted on the X-axes. The height of the bars shows the relative power of the channel.

The graph is calculated from the settings that have been made.

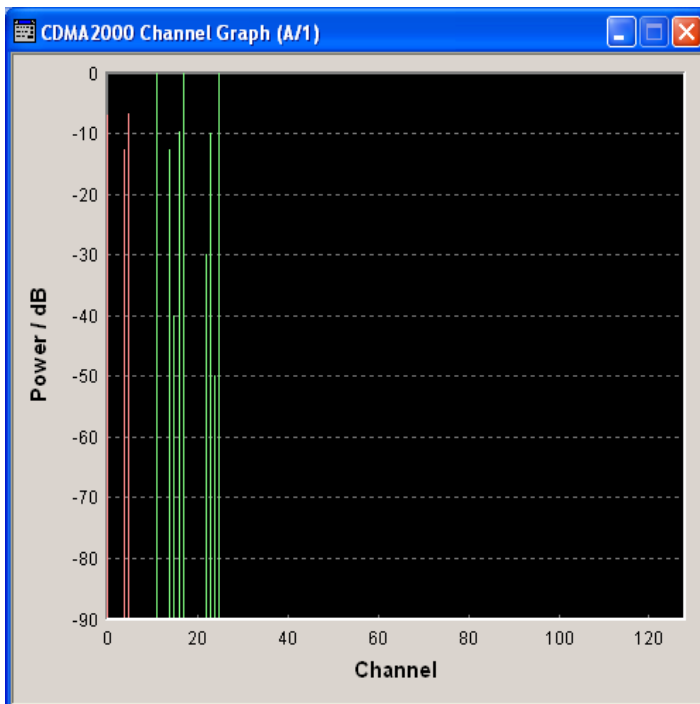

## Channel Table - BS - CDMA2000

The **channel table** is located in the lower part of the menu. The channel table is where the individual channel parameters are set.

Up to 78 channels are available for each base station. Channels 0-1 to 0-11 are assigned to the special channels which are responsible for the correct communication between base station and mobile station. The packet channels (0-12 to 0-14) and the traffic channels (1-0 and above) transmit the data.

A traffic channel is used for transmitting the radio link information, i.e. for communication with the addressee. The traffic channels consists of a dedicated channel, a fundamental channel and, depending on the radio configuration of up to 7 supplemental channels.

The packet data channel and the packet data control channels are used for transmitting data packets (packet data service) usually at higher data rates than is the case with purely circuit-mode traffic channels. The radio configuration of these channels is defined as 10 in accordance with the cdma2000 standard.

The number of sub channels and the sub channel types of a traffic channel depend on the selected radio configuration. The radio configuration can be set separately for each traffic channel and is the same for all sub channels of this traffic channel. It determines among other things the channel coding types, the frame lengths and the data rates that can be used and the settings of fixed parameter , e.g. CRC length. The R&S Vector Signal Generator provides a separate set of settings of all channel table parameters for each radio configuration. Thus, when the radio configuration is changed, the current set of settings is internally stored for the old radio configuration and the complete set of settings belonging to the new radio configuration is activated and indicated in the channel table.

Channel 0-5 (F-SYNC) and the first traffic channel can be generated in real time.

	Channel Type	Real Time	RC	Frame Length [ms]	Data Rate [kbps]	Walsh	Q. Orth.	Power [dB]	Data	Dlist Pattern	More Params	State	Dom Conf
1	F-PICH			20.0	1.2	0	Off	0	PN 9		Config..	On	
2	F-TDPICH			20.0	1.2	0	Off	0	PN 9		Config..	On	
3	F-APICH			20.0	1.2	0	Off	0	PN 9		Config..	On	
4	F-ATDPICH			20.0	1.2	0	Off	0	PN 9		Config..	On	
5	F-SYNC	On		20.0	2.4	0	Off	0	PN 9		Config..	On	
6	F-PCH			20.0	9.6	0	Off	0	PN 9		Config..	On	
7	F-BCH			20.0	9.6	0	Off	0	All 1		Config..	On	
8	F-QPCH			20.0	1.2	0	Off	0	PN 9		Config..	On	
9	F-CPCCH			20.0	1.2	0	Off	0	PN 9		Config..	On	
10	F-CACH			20.0	1.2	0	Off	0	PN 9		Config..	On	
11	F-CCCH			20.0	1.2	0	Off	0	PN 9		Config..	On	
12	F-PDCCH		10			0	Off	0	PN 9		Config..	Off	
13	F-PDCCH		10			0	Off	0	PN 9		Config..	On	



**Channel Number - BS -  
CDMA2000**

Displays the channel numbers.

The channel number is made up of 2 numbers. If the first number is 0 it identifies the special channels, i.e. the control channels and packet channels. A first number of 1 to 8 designates the traffic channels. The second number refers consecutively to the special channels or the sub-channels of a traffic channel.

All available channels are always displayed, even those that are inactive. The number of sub-channels per traffic channel 1 (four or eight) depends on the chosen radio configuration.

Each channel is switched on and off by the **On/Off** button in the **State** column.

Remote-control command: n.a.

During remote control the channel is selected via the suffix to the keywords :CGRoup<n>:COFFset<n>. Then CGRoup0 selects the special channels group, CGRoup1 to 8 the traffic channel. COFFset1 to 14 selects either the special channel or the code channel of a traffic channel. E.g. :CGRoup0:COFFset14 selects the packet channel F-PDCH, :CGRoup3:COFFset1 selects the F-FCH of traffic channel 3.

**Channel Type - BS -  
CDMA2000**

Indication of the channel type (see following table).

Remote-control command:

SOUR:BB:C2K:BST4:CGR1:COFF1:TYPE?

Response: "F-FCH"

Table 4-26 List of supported channel types and their sequence in the CDMA2000 channel table

Index	Shortform	Name	Function
0-1	F-PICH	Forward Pilot Channel	The base station continuously transmits the pilot channel. This channel provides capabilities for soft <i>handoff</i> and coherent detection. Handoff is a procedure where a mobile with an on-going call changes channel and/or base station under the supervision of the network. The Walsh code is 0.
0-2	F-TDPICH	Forward Transmit Diversity Pilot Channel	The base station continuously transmits this pilot channel from the secondary antenna when transmit diversity is enabled.
0-3	F-APICH	Forward Auxiliary Pilot Channel	This pilot channel transmits the base station as an option.
0-4	F-ATDPICH	Forward Auxiliary Transmit Diversity Pilot Channel	The base station optionally transmits this pilot channel from the secondary antenna when transmit diversity is enabled.
0-5	F-SYNC	Forward Synchronisation Channel	The synchronization channel enables the mobile station to synchronize with the base station. It contains the PN offset, the system time and the long code status, information about the paging channel, together with the system ID and the network ID. The Walsh code is 32.
0-6	F-PCH	Forward Paging Channel	The paging channel carries control information specific to a mobile station when the network does not know where the mobile station is located.
0-7	F-BCCH	Forward Broadcast Channel	The broadcast channel is used to broadcast system- and cell-specific information.
0-8	F-QPCH	Forward Quick Paging Channel	The paging channel contains short form information for the mobile station, particularly if the latter is not transmitting.
0-9	F-CPCCH	Forward Common Power Control Channel	
0-10	F-CACH	Forward Common Assignment Channel	
0-11	F-CCCH	Forward Common Control Channel	General channel for transmitting control information. It also provides a mean for paging functions but it supports different data rates. It provides capability for short burst data communications.
0-12/13	F-PDCCH	Forward Packet Data Control Channel	The Forward Packet Data Control Channel carries the control information for the Forward Packet Data Channel.
0-14	F-PDCH	Forward Packet Data Channel	Packet oriented data channel, supports high data rates
1-1	F-FCH	Forward Fundamental Channel	Subchannel of a traffic channel. Contains control data and user data.
1-2	F-SCCH1	Forward Supplemental Code Channel	Subchannel of a traffic channel. Enables higher data rates for control and user data.
1-2	F-SCH1	Forward Supplemental Channel	Subchannel of a traffic channel. Enables higher data rates for control and user data.
...			
1-4	F-DCCH	Forward Dedicated Control Channel (RC3, RC4 and RC5)	Subchannel of a traffic channel. It transports specific control information.

**Real Time - BS1 -  
CDMA2000**

Activates realtime generation of the channel. This option is only available for the sync channel F-SYNC and the first traffic channel.

The channel state, Real Time On or Off, is displayed in different colors. The set state for the first traffic channel is specific for the selected radio configuration.

To test the BER/BLER testers (e.g. integrated in the base station), it is possible to feed through artificial bit errors to all the data sources (and block errors to the CRC checksum).

Remote-control command:

```
SOUR:BB:C2K:BST:CGR1:COFF1:REAL:STAT ON
```

**Radio Configuration (RC) -  
BS - CDMA2000**

Select radio configuration of the traffic channel.

The radio configuration determines the channel types, the frame lengths, the channel coding types and the data rates that can be used.

The radio configuration is the same for all sub channels of a traffic channel. If the radio configuration is modified for one of the sub channels the new value is then automatically used by all other sub-channels of this traffic channel.

The radio configuration for the packet channels F-PDCCH and F-PDCH is fixed to RC10.

The R&S Vector Signal Generator provides a separate set of settings of all channel table parameters for each radio configuration. Changing the radio configuration causes the settings belonging to the new RC value to be activated in the channel table (the settings belonging to the old RC value are stored).

The radio configuration determines the permissible frame lengths. The frame length defines the permitted data rate and channel coding type which in turn determine the permitted Walsh codes.

This gives rise to a hierarchy within the following parameters:

Frame Length -> Data Rate + Channel Coding Type -> Walsh Code

Changing one of the parameters in this hierarchy automatically causes the lower-level settings to be changed if they are no longer permitted following the change to the higher-level parameter.

Remote-control command:

```
SOUR:BB:C2K:BST4:CGR2:RCON 1
```

**Frame Length- BS -  
CDMA2000**

Enters the frame length of the channel. The set value is specific for the selected radio configuration.

The value range depends on the channel type and radio configuration. The frame length of the F-SCH is fixed to 26.6.ms. The maximum frame length is 160 ms, the minimum frame length is 5 ms.

The frame length affects the data rates and the channel coding types that are possible within a channel. Changing the frame length may lead to a change of data rate and/or the channel coding type and this in turn may bring about a change of Walsh code.

Remote-control command:

```
SOUR:BB:C2K:BST4:CGR1:COFF3:FLEN 20ms
```

**Data Rate - BS - CDMA2000**

Enters the data rate of the channel. The set value is specific for the selected radio configuration.

The R&S Vector Signal Generator supports all data rates between 1.2 kbps and 1,036.8 kbps defined in the standard.

The value range depends on the frame length. If the frame length is changed so that the set data rate becomes invalid, the next permissible value is automatically set.

The data rate affects the Walsh code (spreading factor) that are possible within a channel. If a data rate is changed so that the selected Walsh code becomes invalid, the next permissible value is automatically set.

Remote-control command:

```
SOUR:BB:C2K:BST4:CGR1:COFF1:DATA:RATE DR3K6
```

**Walsh Code - BS -  
CDMA2000**

Assigns the Walsh Code to the channel (see Section "[Variable-Length Walsh Spreading - Downlink](#)", Page 4.538, and see Section "[Code Domain Graph - BS - CDMA2000](#)", Page 4.575). The set value is specific for the selected radio configuration.

The code channel is spread with the set Walsh code (spreading code).

The value range of the Walsh code depends on the frame length, the channel coding type and the data rate.

If one of these parameters is changed so that the set Walsh code gets invalid, the next permissible value is automatically set.

The standard assigns a fixed Walsh code to some channels (F-PICH, for example, always uses Walsh code 0). Generally, the Walsh code can only be varied within the range specified by the standard.

Remote-control command:

```
SOUR:BB:C2K:BST4:CGR1:COFF1:WCOD 63
```

**Quasi Orthogonal Walsh Code State - BS - CDMA2000**

Activates/deactivates the use of the quasi orthogonal Walsh codes for the channel. The set state is specific for the selected radio configuration.

Depending on the channel type and other parameters, the standard does not allow the use of quasi-orthogonal codes. In this case the selection field is dimmed.

The quasi orthogonal Walsh Code set is selected for all channels of the base station in the upper area of the CDMA200 menu.

Remote-control command:

SOUR:BB:C2K:BST4:CGR1:COFF1:QWC:STAT ON

**Power - BS - CDMA2000**

Sets the channel power in dB. The set value is specific for the selected radio configuration.

The power entered is relative to the powers outputs of the other channels. If **Adjust Total Power to 0 dB** is executed (top level of the CDMA menu), all the power data is relative to 0 dB.

The set **Power** value is also the start power of the channel for **Misuse For Output Power Control**.

**Note:**

*The maximum channel power of 0 dB applies to non-blanked channels (duty cycle 100%), with blanked channels, the maximum value can be increased (by Adjust Total Power) to values greater than 0 dB (to).*

Remote-control command:

SOUR:BB:C2K:BST4:CGR1:COFF1:POW -20

**Data - BS - CDMA2000**

Selects data source. The set value is specific for the selected radio configuration.

**All 0** 0 data or 1 data is internally generated.

**All 1** Remote-control command  
SOUR:BB:C2K:BST3:CGR2:COFF1:DATA  
ZERO | ONE

**PN xx** PRBS data in accordance with the IUT-T with period lengths between  $2^9-1$  and  $2^{23}-1$  are internally generated.

Remote-control commands:

SOUR:BB:C2K:BST3:CGR2:COFF1:DATA

PN9 | PN11 | PN15 | PN16 | PN20 | PN21 | PN23

<b>Pattern Pattern</b>	<p>A user-definable bit pattern with a maximum length of 64 bits is internally generated.</p> <p>The bit pattern is defined in the <b>Pattern</b> input box.</p> <p>Remote-control command:  SOUR:BB:C2K:BST3:CGR2:COFF1:DATA  PATT  SOUR:BB:C2K:BST3:CGR2:COFF1:DATA:PATT  #H3F, 8</p>
<b>Data List Select Data List</b>	<p>Data lists will be used. Data lists can be generated internally in the data editor or externally.</p> <p>Data lists are selected in the <b>Select Data List</b> field.</p> <p>Remote-control command:  SOUR:BB:C2K:BST3:CGR2:COFF1:DATA  DLIS  SOUR:BB:C2K:BST3:CGR2:COFF1:DATA:DSEL  "BS_CDMA"</p>
<b>More Params - BS - CDMA2000</b>	<p>Calls the menu for setting additional parameters of the selected channel (see Section "<a href="#">More Parameters - BS Channel Table CDMA2000</a>", Page 4.587).</p> <p>Remote-control command: -</p>
<b>Channel State - BS - CDMA2000</b>	<p>Activates or deactivates the channel. The set state is specific for the selected radio configuration.</p> <p>Remote-control command:  SOUR:BB:C2K:BST3:CGR2:COFF1:STAT ON</p>
<b>Domain Conflict - BS - CDMA2000</b>	<p>Displays whether the channel has a code domain conflict with one of the other channel. If there is a conflict, a red dot appears and the column is colored soft orange. If there is no conflict, the column is colored soft blue. The indicated value is specific for the selected radio configuration.</p> <p>To call the graphical display of code domain occupancy by all the active code channels, use the <b>Code Domain</b> button (also see "<a href="#">Code Domain Graph - BS - CDMA2000</a>", Page 4.575).</p> <p>Remote-control command:  SOUR:BB:C2K:BST3:DCON:STAT?  Response: 1  SOUR:BB:C2K:BST3:DCON:RES</p>

## More Parameters - BS Channel Table CDMA2000

The **More Parameters** menu can be called in the BS channel table in column **More Params** with button **Config...**. The indicated values and the settings are specific for the selected radio configuration.

The settings for the packet channel F-PDCH channel and all other channels are different (see Section "[More Parameters for F-PDCH - BS - CDMA2000](#)", Page 4.596). The menu for the special channels and the traffic channels is described below.

Channel No.	1-1
Channel Type	F-FCH
Walsh Length	64
LC Mask (hex)	0

The upper section is where the channel number, channel type and Walsh length of the selected channel is displayed.

Power Control	
Data Source	All 0
Read Out Mode	Continuous
For Output Power Control	<input type="checkbox"/> (Mis-)Use
Power Step	0.00 dB

The **Power Control** section is where the settings for the power control bits are made.

This section is only available for the traffic sub channels F-FCH and F-DCCH.

Channel Coding	
Coding Mode	Complete
Data Rate	9.60 kbps
Source Bits / Frame	172
CRC Length	12
Coder Type	Conv Encoder 1/4
Symbol Repetition	1
Symbol Puncture	
Block Interleaver	768 Symbols

The **Channel Coding** section is where the channel coding settings are made.

Bit Error Insertion	
State	<input type="checkbox"/>
Bit Error Rate	0.001 000 0
Block Error Insertion	
State	<input type="checkbox"/>
Block Error Rate	0.100 0

The **Bit/Block Error Insertion** section is where the bit/block error simulation is configured and activated.

This section is only available for the real time channels.

<b>Channel No - More Parameters BS - CDMA2000</b>	Displays the channel number of the channel being configured. Remote-control command: n.a.
<b>Channel Type - More Parameters BS - CDMA2000</b>	Displays the type of the channel being configured. Remote-control command: n.a.
<b>Walsh Length - More Parameters BS - CDMA2000</b>	Displays the Walsh code of the channel being configured . The indicated value is specific for the selected radio configuration. Remote-control command: SOUR:BB:C2K:BST4:CGR2:COFF1:WLEN? Response: 64
<b>LC Mask - More Parameters BS - CDMA2000</b>	(hex) Enters the mask of the long-code generator in hexadecimal form. The set value is specific for the selected radio configuration.  The long-code mask is a 42-bit value. The mask serves for channel-specific and user-specific scrambling of the code channel. The value range is 0 to 3FF FFFF FFFF.  The LC Mask is the same for all sub channels of a traffic channel. If the mask is modified for one of the sub channels the new value is then automatically used by all other sub-channels of this traffic channel.  Remote-control command: SOUR:BB:C2K:BST4:CGR2:COFF1:LCM #H0



## Power Control - More Parameters BS - CDMA2000

The **Power Control** section is where the settings for the power control bits are made. These bits are used to control the transmit power. This section is only available for the traffic sub channels F-FCH and F-DCCH.

### Data Source - Power Control - BS - CDMA2000

Defines the data source for the power control bits of the channel. The set value is specific for the selected radio configuration.

When **Pattern** is selected, an entry field appears for the bit pattern. The maximum bit pattern length is 64 bits.

When **Data List** is selected, a button appears for calling the **File Select** window.

Remote-control command:

```
SOUR:BB:C2K:BST2:CGR3:COFF1:TPC:DATA ZERO | ONE
SOUR:BB:C2K:BST2:CGR3:COFF1:TPC:DATA PATT
SOUR:BB:C2K:BST2:CGR3:COFF1:TPC:DATA:PATT #H3F,8
SOUR:BB:C2K:BST2:CGR3:COFF1:TPC:DATA DLIS
SOUR:BB:C2K:BST2:CGR3:COFF1:TPC:DATA:DSEL "tpc_bts"
```

### Read Out Mode (Power Control) - BS - CDMA2000

Defines power control bits usage. The set value is specific for the selected radio configuration.

With CDMA, the power control bits are used to signal the increase or reduction in transmit power to the called station.

The base station sends power control bits in the traffic channel at an 800 Hz rate instead of the scrambled data bits. The mobile station increases or decrease its output power depending on these power control bits. One to four data bits (depending on the data rate) are replaced a corresponding number of power control bits („0...0“ or „1...1“).

With all read out modes, one bit is taken from the power control, multiplied and entered into the bit stream. The difference between the modes lies in the usage of the power control bits.

These different modes can be used, for example, to deliberately set a base station to a specific output power (e.g. with the pattern 11111) and then let it oscillate around this power (with Single + alt. 01 and Single + alt. 10). This then allows power measurements to be carried out at the base station (at a quasi-constant power). Together with the option (Mis-)Use for output power control (see below), Read Out Mode can also be used to generate various output power profiles.

**Continuous:** The power control bits are used cyclically.

Remote-control command:

```
SOUR:BB:C2K:BST2:CGR3:COFF1:TPC:READ
CONT
```

- Single + All 0** The power control bits are used once, and then the power control sequence is continued with 0 bits.
- Remote-control command:  
SOUR:BB:C2K:BST2:CGR3:COFF1:TPC:READ  
S0A
- Single + All 1** The power control bits are used once, and then the power control sequence is continued with 1 bits.
- Remote-control command:  
SOUR:BB:C2K:BST2:CGR3:COFF1:TPC:READ  
S1A
- Single + alt. 01** The power control bits are used once and then the power control sequence is continued with 0 and 1 bits alternately (in multiples, depending on by the data rate, for example, 00001111).
- Remote-control command:  
SOUR:BB:C2K:BST2:CGR3:COFF1:TPC:READ  
S01A
- Single + alt. 10** The power control bits are used once and then the Power control bit sequence is continued with 1 and 0 bits alternately (in multiples, depending on by the data rate, for example, 11110000).
- Remote-control command:  
SOUR:BB:C2K:BST2:CGR3:COFF1:TPC:READ  
S10A

**Misuse for Output Power Control - BS - CDMA2000**

Activates "mis-" use of the power control data. The set value is specific for the selected radio configuration.

With CDMA, the power control bits are used to signal the increase or reduction in transmit power to the called station. If **(Mis-) use for output power control** is activated, the specified pattern is misused, in order to vary the intrinsic transmit power over time. Every 1.25 ms (800 Hz) a bit of this pattern is removed in order to increase (bit = "1") or reduce (bit = "0") the channel power by the specified power step (**Power Step**). The upper limit for this is 0 dB and the lower limit -80 dB. The following envelope is produced at a channel power of 0 dB, power step 1.0 dB and pattern "001110100000011" and Pattern ReadOut Mode **Continuous**:

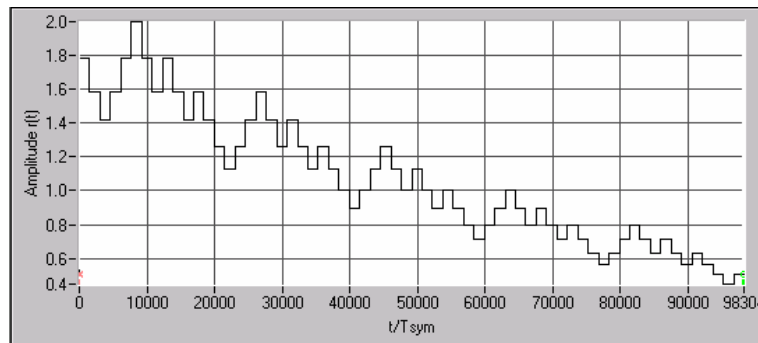

Fig. 4-54 Dynamic change of channel power (continuous)

**Note:**

*The first bit is assigned to the first power control section. In this first section the start power specified in the channel table is always used, i.e. only in the next power control section (with the second power control bit) will the defined power change be effective.*

Remote-control command:

```
SOUR:BB:C2K:BST2:CGR3:COFF1:TPC:MIS ON
```

**Power Step (DPCCH) - BS - CDMA2000**

Sets the step width of the power change in dB for **(Mis-) use for output power control**. The set value is specific for the selected radio configuration.

Remote-control command:

```
SOUR:BB:C2K:BST2:CGR3:COFF1:TPC:PST 1.0
```

## Channel Coding - More Parameters BS - CDMA2000

The **Channel Coding** section or menu **More Parameters** is where the channel coding settings are made. The indicated values and the settings are specific for the selected radio configuration.

In contrast to 3GPP FDD, channel coding with CDMA2000 is part of the physical layer. The channel coding procedure may slightly vary depending on channel type, frame length and data rate.

### Channel Coding Mode - More Params BS - CDMA2000

Activates or deactivates channel coding. The set state is specific for the selected radio configuration.

#### Off

Channel coding is deactivated.

Channel coding is not performed. The data sources of the individual channels apply their data stream directly to the long-code scrambler. The data source supplies the traffic data with the data rate that would be available at the long-code scrambler after coding is switched on. This effective data rate, which is used for reading off from the data source, is displayed under **Effective Data Rate**. The **Data Rate** parameter displayed in the channel table continues to affect the **Effective Data Rate**, but no longer agrees with it.

Remote-control command:

```
SOUR:BB:C2K:BST2:CGR3:COFF1:CCOD:MODE
OFF
```

#### Complete

The complete channel coding is performed. The channel coding procedure may slightly vary depending on channel type, frame length and data rate.

Remote-control command:

```
SOUR:BB:C2K:BST2:CGR3:COFF1:CCOD:MODE
COMP
```

#### Without Interleaving

Except for the block interleaver, the whole channel coding procedure is carried out. In this mode the frame structure and the convolutional coder of an receiver can be tested.

Remote-control command:

```
SOUR:BB:C2K:BST2:CGR3:COFF1:CCOD:MODE
NOIN
```

**Interleaving Only**

In this mode only block interleaver is used for coding. This allows the deinterleaver in the receiver to be tested independently of the remaining (de-)coding process.

Remote-control command:

```
SOUR:BB:C2K:BST2:CGR3:COFF1:CCOD:MODE
OINT
```

**Effective Data Rate - More Params BS - CDMA2000**

Indication of the effective data rate. The indicated value is specific for the selected radio configuration.

For coding modes **Interleaving Only** and **Coding Off** the effective data rate differs from the set data rate, since no increase in the data rate is brought about by the convolution coder. The data rate set in the channel table is therefore not correct.

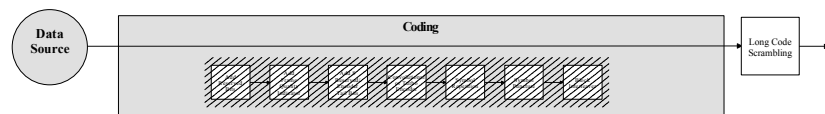

For coding modes **Without Interleaving** and **Complete** the data rate in the channel table agrees with the effective data rate, since there is an increase in the data rate due to the convolution coder.

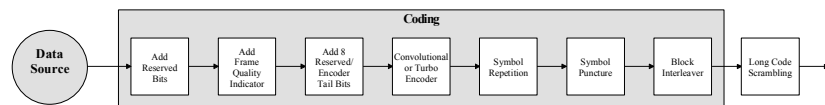

Remote-control command:

```
SOUR:BB:C2K:BST4:CGR3:COFF1:CCOD:DATA:RATE?
```

**Source Bits / Frame - More Params BS - CDMA2000**

Indication of the number of input bits per frame for the channel coder. The indicated value is specific for the selected radio configuration.

Remote-control command:

```
SOUR:BB:C2K:BST4:CGR3:COFF1:CCOD:BITF?
```

**CRC Length - More Params BS - CDMA2000**

Indication of the CRC (cyclic redundancy code) type (length) for error identification. The indicated value is specific for the selected radio configuration.

Remote-control command:

```
SOUR:BB:C2K:BST4:CHAN108:CCOD:CRC?
```

<b>Channel Coder Type - More Params BS - CDMA2000</b>	<p>Selects error protection. The set value is specific for the selected radio configuration.</p> <p>Which coder types are available depends on the channel type and other channel settings such as frame length, etc.</p> <p>If one of these parameters is changed so that the set channel coding type gets invalid, the next permissible value is automatically set.</p> <p><b>Off</b></p> <p>No error protection. This selection is available for the pilot channels only.</p> <p>Remote-control command: SOUR:BB:C2K:BST:CGR3:COFF1:CCOD:TYPE OFF</p> <p><b>Conv Encoder</b></p> <p>Convolution Coder with generator polynomials defined by CDMA. The numeric value defines the rate of the convolution coder.</p> <p>Remote-control command: SOUR:BB:C2K:BST:CGR3:COFF1:CCOD:TYPE CON2   CON3   CON4   CON6</p> <p><b>Turbo Encoder</b></p> <p>Turbo Coder of rate 1/3 in accordance with the CDMA specifications. The numeric value defines the rate of the turbo coder.</p> <p>Remote-control command: SOUR:BB:C2K:BST:CGR3:COFF1:CCOD:TYPE TURB3   TURB4   TURB5</p>
<b>Symbol Repetition - More Params BS - CDMA2000</b>	<p>Indication of the symbol repetition rate. The indicated value is specific for the selected radio configuration.</p> <p>Symbol repetition is used together with block symbol puncture for adapting the convolutional or turbo coder output data rate to the required input data rate of the interleaver.</p> <p>Remote-control command: SOUR:BB:C2K:BST4:CGR3:COFF1:CCOD:SREP?</p>
<b>Symbol Puncture - More Params BS - CDMA2000</b>	<p>Indication of the symbol puncture rate. The indicated value is specific for the selected radio configuration.</p> <p>Symbol puncturing (elimination) is used together with block symbol repetition for adapting the convolutional or turbo coder output data rate to the required input data rate of the interleaver.</p> <p>Remote-control command: SOUR:BB:C2K:BST4:CGR3:COFF1:CCOD:SPUN?</p>

**Block Interleaver - More  
Params BS - CDMA2000**

Displays the number of symbols that the interleaver processes per block. The indicated value is specific for the selected radio configuration.

Remote-control command:  
SOUR:BB:C2K:BST4:CGR3:COFF1:CCOD:BINT?

**Error Insertion - More Params BS - CDMA2000**

In the **Bit Error Insertion** and **Block Error Insertion** sections of the **More Params** menu, errors can be inserted into the data source and into the CRC checksum, in order, for example, to check the bit and block error rate testers.

These functions are available for realtime channels only.

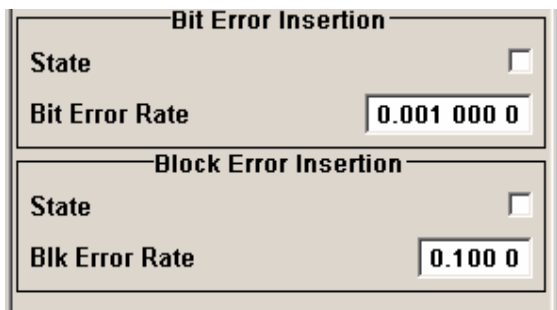

**Bit Error State - More  
Params BS - CDMA2000**

Activates or deactivates bit error generation .

Bit errors are inserted into the data fields of the realtime channels.

When the data source is read out, individual bits are deliberately inverted at random points in the data bit stream at the specified error rate in order to simulate an invalid signal.

Remote-control command:  
SOUR:BB:C2K:BST:CGR1:COFF4:DERR:BIT:STAT ON

**Bit Error Rate - More  
Params BS - CDMA2000**

Sets the bit error rate.

Remote-control command:  
SOUR:BB:C2K:BST:CGR1:COFF4:DERR:BIT:RATE 1E-3

**Block Error State - More  
Params BS - CDMA2000**

Activates or deactivates block error generation.

The CRC checksum is determined and then the last bit is inverted at the specified error probability in order to simulate an invalid signal.

Block error generation is only possible with channel coding enabled.

Remote-control command:  
SOUR:BB:C2K:BST:CGR1:COFF4:DERR:BLOC:STAT ON

**Block Error Rate - More  
Params BS - CDMA2000**

Sets block error rate.

Remote-control command:

```
SOUR:BB:C2K:BST:CGR1:COFF4:DERR:BLOC:RATE 1E-3
```

## More Parameters for F-PDCH - BS - CDMA2000

The **More Parameters** menu for packet channel F-PDCH can be called in the BS channel table in column **More Params** with button **Config...**

The settings for the packet channel F-PDCH channel and all other channels are different (see Section "[More Parameters - BS Channel Table CDMA2000](#)", Page 4.587). The menu for the special channels and the traffic channels is described below.

The channel coding for the F-PDCHs is always carried out in full (see 3GPP2 C.S0002-C figure 3.1.3.1.1.1-19).

The parameters of both F-PDCCHs (such as Number of Slots per Subpacket, Subpacket Position, etc.) are implicitly defined by the F-PDCH settings, since both these channels are always transmitted simultaneously with the F-PDCH. The **More Parameters** menu for these F-PDCCHs is therefore mostly for display, it only enables the selection of channel coding mode.

The left part is used to enter the general settings for the packet channel.

The right, upper part contains a table for setting the parameters of the subpackets. Up to 8 subpackets can be transmitted for each regular packet.

The right, lower part displays the current configuration of the packet channel in graphical form.



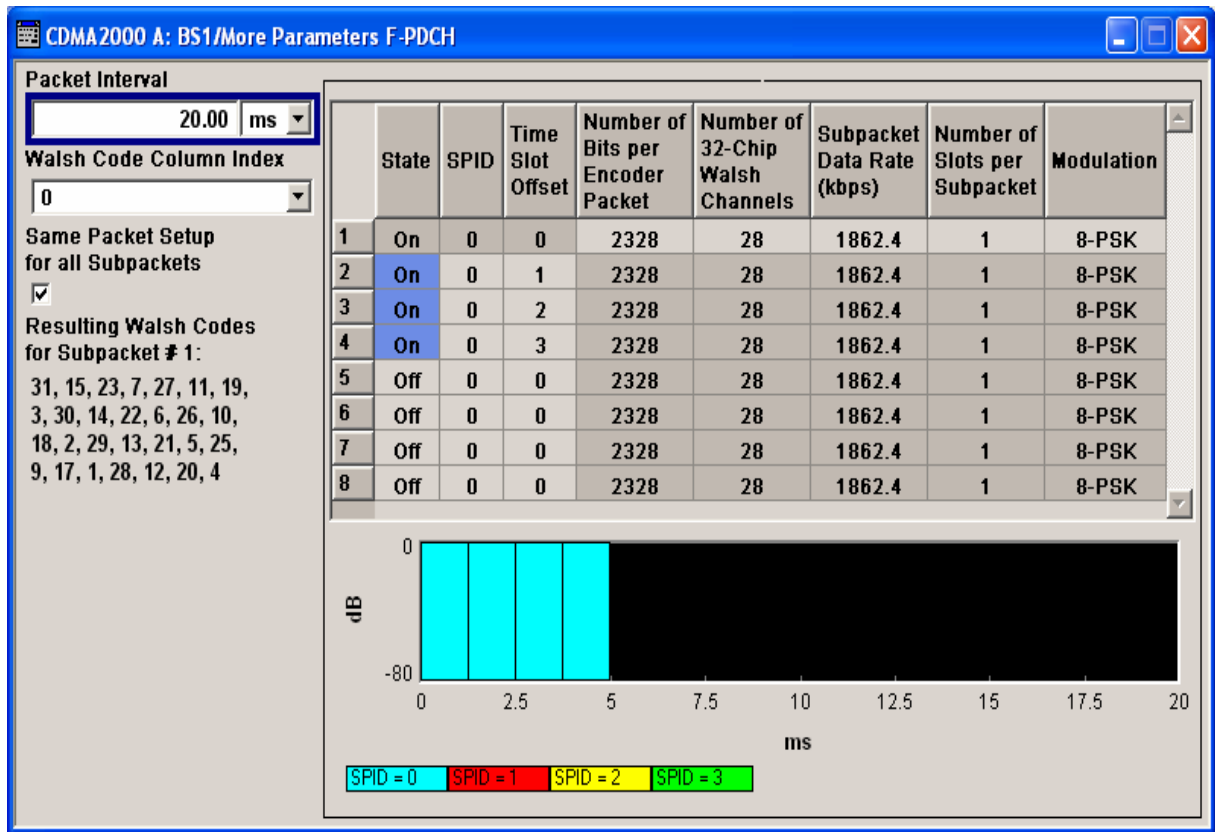

**Packet Interval - More Params F-PDCHs BS - CDMA2000**

Select the interval at which new data packets arrive.

New F-PDCH packets are generated in this interval. Within an interval, up to 8 subpackets of a data packet can be transmitted with any required time offset.

The value range is dependent on the set sequence length (ARB settings). The values 80 ms, 40 ms, 20 ms, 10 ms and 5 ms can always be set, and the maximum value is 2000 ms. All intermediate values must satisfy the condition

$$\text{Sequence Length} * 80\text{ms}/2^n$$

where n is a whole number.

**Example:**

Sequence length = one 80 ms frame.

The possible values for the packet interval are 80 ms, 40 ms, 20 ms, 10 ms and 5 ms .

Sequence length = three 80 ms frames.

The possible values for the packet interval are 240 ms, 120 ms, 80 ms, 40 ms, 20 ms, 10 ms and 5 ms

Remote-control command: -

SOUR:BB:C2K:BST2:PDCH:PINT 40 ms

**Walsh Code Column Index  
- More Params F-PDCHs  
BS - CDMA2000**

Selects the standard-compliant set of available Walsh codes for the F\_PDCH (see 3GPP2 C.S0003-C, table 2-35).

Remote-control command: -  
SOUR:BB:C2K:BST2:PDCH:WIND 3

**Same Packet Setup... -  
More Params F-PDCHs BS  
- CDMA2000**

Sets whether or not all subpackets are to be generated with the same settings.

In the case of the **On** setting the packet parameters (Number of Bits etc., see below) can only be changed for subpacket 1. All other subpackets receive the same parameters.

The **Off** setting allows individual settings for each subpacket.

Remote-control command:  
SOUR:BB:C2K:BST2:PDCH:PSET ON

## Subpacket Table- More Para2ms F-PDCHs BS - CDMA2000

The middle part contains a table for setting the parameters of the subpackets. Up to 8 subpackets can be transmitted for each regular packet (Encoder Packet).

	State	SPID	Time Slot Offset	Number of Bits per Encoder Packet	Number of 32-Chip Walsh Channels	Subpacket Data Rate (kbps)	Number of Slots per Subpacket	Modulation
1	On	0	0	2328	28	1862.4	1	8-PSK
2	On	0	1	2328	28	1862.4	1	8-PSK
3	On	0	2	2328	28	1862.4	1	8-PSK
4	On	0	3	2328	28	1862.4	1	8-PSK
5	Off	0	0	2328	28	1862.4	1	8-PSK
6	Off	0	0	2328	28	1862.4	1	8-PSK
7	Off	0	0	2328	28	1862.4	1	8-PSK
8	Off	0	0	2328	28	1862.4	1	8-PSK

### Subpacket Number - More Params F-PDCHs BS - CDMA2000

Index number of the subpackets in the selected channel. Each packet can include up to eight subpackets.

Remote-control command: -

The subpacket is selected by the suffix to SUBPacket in remote control.

### Subpacket State - More Params F-PDCHs BS - CDMA2000

Status of the subpacket.

Subpacket 1 is always active. The rest can be turned on and off.

Remote-control command:

SOUR:BB:C2K:BST2:PDCH:SUBP3:STAT ON

### Subpacket ID - More Params F-PDCHs BS - CDMA2000

Selects the subpacket ID.

The subpacket ID controls the subpacket symbol selection and adopts one of four possible subpackets from the encoder packet.

The ID of the first subpacket is fixed at 0. The ID can be chosen for each of the rest.

Remote-control command:

SOUR:BB:C2K:BST2:PDCH:SUBP3:ID 1

**Time Slot Offset - More  
Params F-PDCHs BS -  
CDMA2000**

Sets the starting time of the subpacket relative to the starting time of the packet interval.

The first subpacket always has an offset of 0, which cannot be changed. The value range for the individual subpackets depends on the settings of the other subpackets:

The time slot offsets of the remaining subpackets must be entered in ascending order. Also it is not permitted to transmit two packets simultaneously.

**Example:**

Subpacket 2 is transmitted in time slot 5 and is 4 slots long. Subpacket 3 can only be transmitted in time slot 9 and no sooner.

In total the value range is 0 to (Packet Interval/1.25 ms -Number of Slots per Subpacket).

**Example:**

Packet Interval = 20 ms, Number of Slots per Subpacket = 2. The value range is 0 to 14.

The entry for **Number of Slots per Subpacket** defines the length of a packet.

Remote-control command:

SOUR:BB:C2K:BST2:PDCH:SUBP3:TOFF 3

**Number of Bits per  
Encoder Packet - More  
Params F-PDCHs BS -  
CDMA2000**

Sets the number of bits per encoder packet.

Only certain combinations of this parameter with the parameters of the following four table columns are possible. These combinations are shown in the selection list in the form of a table for all five parameters.

Number of Bits per Encoder Packet	Number of 32-Chip Walsh Channels	Subpacket Data Rate (kbps)	Number of Slots per Subpacket	Modulation
2328	28	1862.4	1	8-PSK
2328	28	1862.4	1	8-PSK
3864	27	1545.6	2	QPSK
3096	26	2476.8	1	16-QAM
3864	26	3091.2	1	16-QAM
1560	25	1248.0	1	QPSK
2328	25	1862.4	1	8-PSK
3096	25	1238.4	2	QPSK
3864	25	1545.6	2	8-PSK
2328	23	931.2	2	QPSK
2328	23	1862.4	1	16-QAM

The **Number of Bits per Encoder Packet** defines the number of data bits that can be read from the data source for an encoder packet. Due to the channel coding this number is multiplied by a factor of about 5. The subsequent subpacket symbol selection then divides these bits into four different subpackets which can be selected via the SPID parameter.

The **Number of Bits per Encoder Packet** can only be changed for subpacket 1. This value must be identical for the remaining subpackets, since they are all part of a single encoder packet.

Remote-control command:

SOUR:BB:C2K:BST2:PDCH:SUBP1:PAR 63

<b>Number of 32-Chip Walsh Channels - More Params F-PDCHs BS - CDMA2000</b>	<p>Selects the number of 32-chip Walsh channels.</p> <p>Remote-control command: (a fixed combination of the five parameters is selected using command SOUR:BB:C2K:BST:PDCH:SUBP:PAR)</p>
<b>Subpacket Data Rate (kbps) - More Params F-PDCHs BS - CDMA2000</b>	<p>Selects the data rate of the subpacket.</p> <p>The data rate is the result of the <b>Number of Bits per Encoder Packet</b> divided by the duration of the subpacket (= <b>Number of Slots per Subpacket</b>). Therefore only specified combinations of the <b>Subpacket Data Rate</b> with the <b>Number of Slots per Subpacket</b> at a specified <b>Number of Bits per Encoder Packet</b> are possible.</p> <p>Remote-control command: (a fixed combination of the five parameters is selected using command SOUR:BB:C2K:BST:PDCH:SUBP:PAR)</p>
<b>Number of Slots per Subpacket - More Params F-PDCHs BS - CDMA2000</b>	<p>Selects the number of slots per subpacket. This parameter defines the duration of the subpacket. A slot equals 1.25 ms.</p> <p>The <b>Number of Slots per Subpacket</b> is the result of the <b>Number of Bits per Encoder Packet</b> divided by the data rate. Therefore only specified combinations of the <b>Subpacket Data Rate</b> with the <b>Number of Slots per Subpacket</b> at a specified <b>Number of Bits per Encoder Packet</b> are possible.</p> <p>Remote-control command: (a fixed combination of the five parameters in the table is selected via command SOUR:BB:C2K:BST:PDCH:SUBP:PAR)</p>
<b>Modulation - More Params F-PDCHs BS - CDMA2000</b>	<p>Indication of the modulation type.</p> <p>The modulation type is fix for each combination of the above parameters.</p> <p>Remote-control command: (a fixed combination of the five parameters is selected using command SOUR:BB:C2K:BST:PDCH:SUBP:PAR)</p>
<b>Resulting Walsh Codes for Subpacket - More Params F-PDCHs BS - CDMA2000</b>	<p>Indication of the resulting Walsh codes for the sub packet</p> <p>Remote-control command: SOUR:BB:C2K:BST2:PDCH:SUBP3:RES:WCOD?</p>

## Subpacket Graph - More Params F-PDCHs BS - CDMA2000

The current configuration of the packet channel and its active subpackets is displayed in graphical form below the table.

The X axis is the length of the set packet interval in ms, i.e. the duration of the transmission of an encoder packet.

The relative power of the subpackets is represented on the Y axis. The subpackets are shown as bars and are 1, 2 or 4 time slots wide according to the configuration. The position on the X axis corresponds to the selected time slot offset.

The color of the bar depends on the sub packet ID (SPID). The assignment of colors to SPIDs is shown below the graph

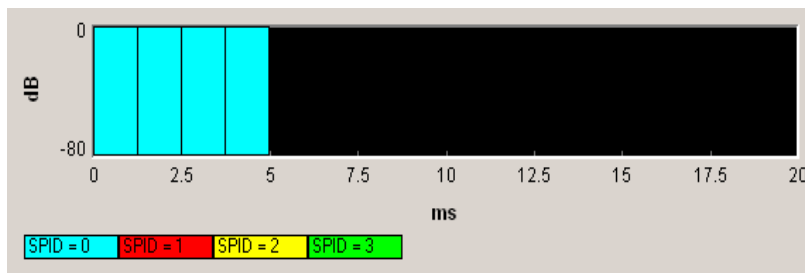

## Mobile Station Configuration (MS)- CDMA2000

The **Mobile Station Configuration** menu is called by selecting mobile station **MS1 ... MS4** in the CDMA2000 menu.

Mobile station 1 (MS1) generates all the channels in realtime, the other mobile stations generate the channels in arbitrary waveform mode.

The menu is divided into the sections **Common Settings**, **Power Control** and **Channel Table**.

The structure of the channel table depends on the selected operating mode and - for the traffic channel - on the selected radio configuration.

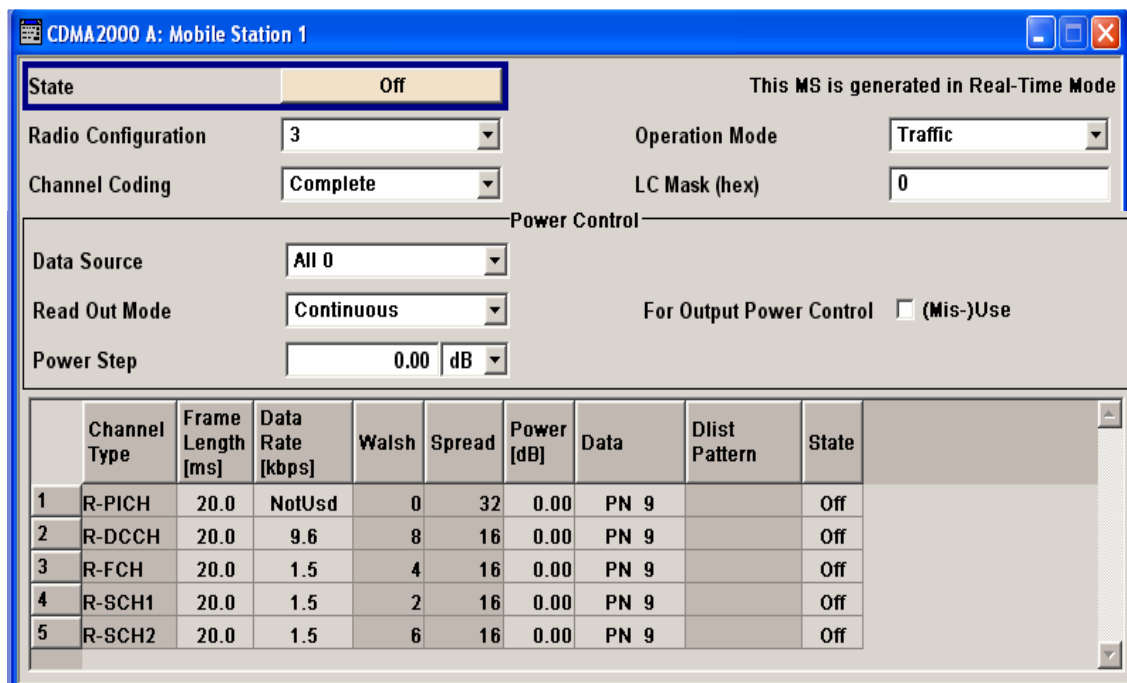

## Common Settings - MS - CDMA2000

The **Common Settings** section is where the general settings for the selected mobile station are made.

### State - MS - CDMA2000

Activates or deactivates the selected mobile station. The number of the selected mobile station is specified in the menu header.

Remote-control command:

SOUR:BB:C2K:MST1:STAT ON

### Operating Mode - MS - CDMA2000

Selects the mode in which the mobile station is to work.

The operating mode defines the generated channel types. The lower part of the menu will change in accordance with the mode. The following modes are available:

<b>Traffic</b>	<p>In this mode the instrument generates a single traffic channel. A traffic channel consists of up to 8 sub channels depending on the selected radio configuration.</p> <p>This mode corresponds to the standard mode of a mobile station during voice and data transmission.</p> <p>Remote-control command: SOUR:BB:C2K:MST2:MODE TRAF</p>
<b>Access</b>	<p>In this mode, the instrument generates an access channel (R-ACH). This channel is needed to set up the connection between the mobile station and the base station.</p> <p>Remote-control command: SOUR:BB:C2K:MST2:MODE ACC</p>
<b>Enhanced Access</b>	<p>In this mode, the instrument generates an enhanced access channel (R-ACH) and a pilot channel (R-PICH). These channels are used to set up the connection between the mobile station and the base station.</p> <p>Remote-control command: SOUR:BB:C2K:MST2:MODE EACC</p>
<b>Common Control</b>	<p>In this mode, the instrument generates a common control channel (R-ACH) and a pilot channel (R-PICH).</p> <p>Remote-control command: SOUR:BB:C2K:MST2:MODE CCON</p>

### Radio Configuration - MS - CDMA2000

Selects the radio configuration for the traffic channel.

In the reverse link, the channel scenario with the spreading codes of the individual channels is predefined by selecting the radio configuration. For this reason the channel table does not contain selection parameters for the Walsh code.

A separate set of settings of all channel table parameters is provided for each radio configuration. Changing the radio configuration causes the settings belonging to the new RC value to be activated in the channel table (the settings belonging to the old RC value are not lost).

The radio configuration determines the permissible frame lengths and the frame length defines the permitted data rate.

Changing the frame length automatically causes the data rate to be changed if it is no longer permitted.

Remote-control command:  
SOUR:BB:C2K:MST:RCON 2



**Channel Coding - MS -  
CDMA2000**

Activates or deactivates channel coding.

**Off**

Channel coding is deactivated.

Remote-control command:

SOUR:BB:C2K:MST2:CCOD OFF

**Complete**

The complete channel coding is performed. The channel coding procedure may slightly vary depending on channel type, frame length and data rate.

Remote-control command:

SOUR:BB:C2K:MST2:CCOD COMP

**Without  
Interleaving**

Except for the block interleaver, the whole channel coding procedure is carried out.

Remote-control command:

SOUR:BB:C2K:MST2:CCOD NOIN

**Interleaving  
Only**

In this mode only block interleaver is used for coding.

Remote-control command:

SOUR:BB:C2K:MST2:CCOD OINT

**LC Mask (hex) - MS -  
CDMA2000**

Enters the mask of the long-code generator in hexadecimal form.

The long-code mask is a 42-bit value. The mask serves for channel-specific and user-specific scrambling of the code channel. The value range is 0 to 3FF FFFF FFFF.

Remote-control command:

SOUR:BB:C2K:MST4:LCM #H5

## Power Control - MS - CDMA2000

The **Power Control** section is where the settings for the power control bits are made. In the uplink, these bits are used exclusively for controlling the mobile station output power by activating the **Mis(use) Power Control** function. Power control puncturing of the data bits of the traffic channels for controlling the base station power is not performed.

This section is only available for the traffic channel.

### Data Source (Power Control) - MS - CDMA2000

Defines the data source for the power control bits of the channel.

When **Pattern** is selected, an entry field appears for the bit pattern. The maximum bit pattern length is 64 bits.

When **Data List** is selected, a button appears for calling the **File Select** window.

Remote-control command:

```
SOUR:BB:C2K:MST2:TPC:DATA ZERO | ONE
SOUR:BB:C2K:MST2:TPC:DATA PATT
SOUR:BB:C2K:MST2:TPC:DATA:PATT #H3F,8
SOUR:BB:C2K:MST2:TPC:DATA DLIS
SOUR:BB:C2K:MST2:TPC:DATA:DSEL "tpc_bts"
```

### Read Out Mode (Power Control) - MS - CDMA2000

Defines read-out mode of power control bits.

Together with the option (Mis-)Use for output power control (see below), Read Out Mode can also be used to generate various output power profiles.

**Continuous:** The power control bits are used cyclically.

Remote-control command:

```
SOUR:BB:C2K:MST2:TPC:READ CONT
```

**Single + All 0** The power control bits are used once, and then the power control sequence is continued with 0 bits.

Remote-control command:

```
SOUR:BB:C2K:MST2:TPC:READ S0A
```

**Single + All 1** The power control bits are used once, and then the power control sequence is continued with 1 bits.

Remote-control command:

```
SOUR:BB:C2K:MST2:TPC:READ S1A
```

**Single + alt. 01** The power control bits are used once and then the power control sequence is continued with 0 and 1 bits alternately.

Remote-control command:

```
SOUR:BB:C2K:MST2:TPC:READ S01A
```

**Single + alt. 10** The power control bits are used once and then the power control sequence is continued with 1 and 0 bits alternately.

Remote-control command:

```
SOUR:BB:C2K:MST2:TPC:READ S10A
```

**Misuse for Output Power Control - MS - CDMA2000**

Activates "mis-" use of the power control data.

In the uplink, the power control bits are used exclusively for controlling the mobile station output power. Power control puncturing is not defined for controlling the base station power

If **(Mis-) use for output power control** is activated, the specified pattern is used to vary the intrinsic transmit power over time. Every 1.25 ms (800 Hz) a bit of this pattern is removed in order to increase (bit = "1") or reduce (bit = "0") the channel power by the specified power step (**Power Step**). The upper limit for this is 0 dB and the lower limit -80 dB. The following envelope is produced at a channel power of 0 dB, power step 1.0 dB and pattern "001110100000011" and Pattern ReadOut Mode **Continuous**:

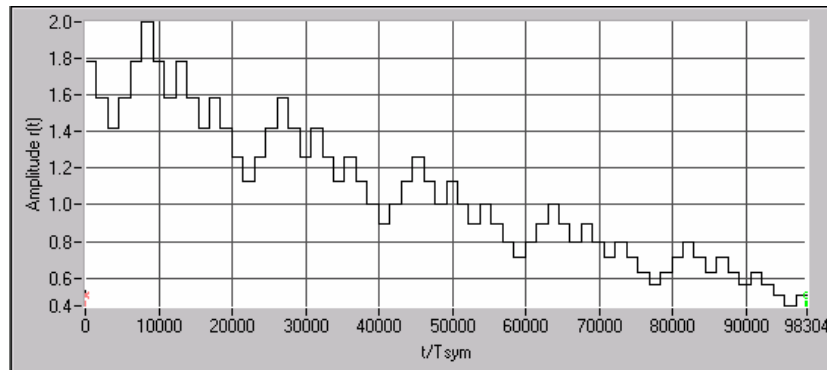

Fig. 4-55 Dynamic change of channel power (continuous)

**Note:**

*The first bit is assigned to the first power control section. In this first section the start power specified in the channel table is always used, i.e. only in the next power control section (with the second power control bit) will the defined power change be effective.*

Remote-control command:

```
SOUR:BB:C2K:MST2:TPC:MIS ON
```

**Power Step - MS - CDMA2000**

Sets the step width of the power change in dB for **(Mis-) use for output power control**.

Remote-control command:

```
SOUR:BB:C2K:MST2:TPC:PST 1.0
```

## Channel Table - MS - CDMA2000

The **channel table** is located in the lower part of the menu. The channel table is where the individual channel parameters are set.

The structure of the channel table depends on the selected operating mode and - for the traffic channel - on the selected radio configuration. Also, for the traffic channels, the indicated values and the settings are specific for the selected radio configuration.

In uplink, the employed Walsh code are determined by the radio configuration cannot be chosen.

The following combinations between the operating modes of the four mobile stations are allowed:

	Traffic,RC1 & RC 2	Traffic, RC3 & RC 4	Access	Enhanced Access	Common Control
Traffic, RC1 & RC 2	X		X		
Traffic, RC3 & RC 4		X		X	X
Access	X		X		
Enhanced Access		X		X	X
Common Control		X		X	X

### Channel Number- MS - CDMA2000

Displays the channel number.

All channels of the selected operating mode are listed. The channels are switched on and off with the **On/Off** button in the **State** column.

Remote-control command: -

(the channel is selected by the suffix at keyword CHANnel<n>)

### Channel Type - MS - CDMA2000

Indication of the channel type (see following table). The possible channel types depend on the selected operating mode of the mobile station.

Remote-control command:

SOUR:BB:C2K:MST4:CHAN1:TYPE?

Response: "R-FCH"

Table 4-27 List of supported channel types

Shortform	Name	Function
<b>Traffic</b>		
R-PICH	Reverse Pilot Channel	The Reverse Pilot Channel provides the capabilities for coherent detection.
R-DCCH	Reverse Dedicated Control Channel	The Reverse Dedicated Control Channel transports mobile-specific control information.
R-FCH	Reverse Fundamental Channel	The Reverse Fundamental Channel is similar to F-FCH; designed to transport dedicated data.
R-SCH	Reverse Supplemental Channel (RC 3 ...5)	The Reverse Supplemental Channels are allocated dynamically to meet a required data rate.
R-SCCH	Reverse Supplemental Code Channel (RC 1 / 2)	The Reverse Supplemental Code Channels are allocated dynamically to meet a required data rate.

Shortform	Name	Function
<b>Access</b>		
R-ACH	Reverse Access Channel	The Access channel is needed to set up the connection between the mobile station and the base station.
<b>Enhanced Access</b>		
R-EACH	Reverse Enhanced Access Channel	The Reverse Enhanced Access Channel is needed to set up the connection between the mobile station and the base station
R-PICH	Reverse Pilot Channel	The Reverse Pilot Channel provides the capabilities for coherent detection.
<b>Common Control</b>		
R-CCCH	Reverse Common Control Channel	The Reverse Fundamental Channel is similar to R-ACH but it is meant to transport control information.

**Frame Length- MS - CDMA2000**

Enters the frame length of the channel. For the traffic channels, the indicated value is specific for the selected radio configuration.

The value range depends on the channel type and the selected radio configuration. The frame length of some channels is fixed. The maximum frame length is 80 ms, the minimum frame length is 5 ms.

The frame length affects the data rates that are possible within a channel. If a frame length is changed so that the set data rate becomes invalid, the next permissible value is automatically set.

Remote-control command:

SOUR:BB:C2K:MST4:CHAN1:FLEN 5ms

**Data Rate- MS - CDMA2000**

Enters the data rate of the channel. For the traffic channels, the indicated value is specific for the selected radio configuration.

The R&S Vector Signal Generator supports all data rates between 1.2 kbps and 1,036.8 kbps defined in the standard.

The value range depends on the frame length. If one of these parameters is changed so that the set data rate becomes invalid, the next permissible value is automatically set.

Remote-control command:

SOUR:BB:C2K:MST4:CHAN1:DATA:RATE DR3K6

**Walsh - MS - CDMA2000**

Assigns the Walsh Code to the channel (see Section "[Spreading - Uplink](#)", Page 4.538). For the traffic channels, the indicated value is specific for the selected radio configuration.

The code channel is spread with the set Walsh code (spreading code). The Walsh codes to be used are specified by the standard and cannot be chosen.

Remote-control command

SOUR:BB:C2K:MST4:CHAN4:WCOD?

**Spread- MS - CDMA2000**

Indication of the spreading factor of the channel. For the traffic channels, the indicated value is specific for the selected radio configuration.

The spreading factor corresponds to the length of the employed Walsh code. The Walsh codes to be used are specified by the standard and cannot be chosen.

Remote-control command :

SOUR:BB:C2K:MST4:CHAN1:SPR?

**Power - MS - CDMA2000**

Enters the channel power in dB. For the traffic channels, the set value is specific for the selected radio configuration.

The power entered is relative to the powers outputs of the other channels. If **Adjust Total Power to 0 dB** is executed (top level of the CDMA2000 menu), all the power data is relative to 0 dB.

The set **Power** value is also the start power of the channel for **Misuse For Output Power Control**.

**Note:**

*The maximum channel power of 0 dB applies to non-blanked channels (duty cycle 100%), with blanked channels, the maximum value can be increased (by Adjust Total Power) to values greater*

*than 0 dB (to  $10 * \log_{10} \frac{1}{duty\_cycle}$ ).*

Remote-control command :

SOUR:BB:C2K:MST4:CHAN1:POW -20

**Data- MS - CDMA2000**

Selects data source. For the traffic channels, the set value is specific for the selected radio configuration.

**All 0** 0 data or 1 data is internally generated.

**All 1**

Remote-control command:

SOUR:BB:C2K:MST3:CHAN3:DATA ZERO | ONE

**PN xx**

PRBS data in accordance with the IUT-T with period lengths between  $2^9-1$  and  $2^{23}-1$  are internally generated.

Remote-control command:

SOUR:BB:C2K:MST3:CHAN3:DATA PN9 | PN11 | PN15 | PN16 | PN20 | PN21 | PN23

<b>Pattern Pattern</b>	<p>A user-definable bit pattern with a maximum length of 64 bits is internally generated.</p> <p>The bit pattern is defined in the <b>Pattern</b> input box.</p> <p>Remote-control command: SOUR:BB:C2K:MST3:CHAN3:DATA PATT SOUR:BB:C2K:MST3:CHAN3:DATA:PATT #H3F,8</p>
<b>Data List Select Data List</b>	<p>Data lists will be used. Data lists can be generated internally in the data editor or externally.</p> <p>Data lists are selected in the <b>Select Data List</b> field.</p> <p>Remote-control command: SOUR:BB:C2K:MST3:CHAN3:DATA DLIS SOUR:BB:C2K:MST3:CHAN3:DATA:DSEL "MST"</p>
<b>Channel State- MS - CDMA2000</b>	<p>Activates/deactivates the channel. For the traffic channels, the indicated value is specific for the selected radio configuration.</p> <p>Remote-control command: SOUR:BB:C2K:MST3:CHAN3:STAT ON</p>

# Digital Standard IEEE 802.11a WLAN

## Introduction - Digital Standard WLAN

The R&S Vector Signal Generator provides you with the ability to generate signals in accordance with the Wireless LAN standards IEEE 802.11a, IEEE 802.11b and IEEE 802.11g. (IEEE 802.11) standard WLAN.

The equipment layout for IEEE 802.11a-g WLAN signal generation includes the options Baseband Main Module (B13), Baseband Generator (B10/B11) and Digital Standard IEEE 802.11a-g WLAN (K48). B10 features a much larger ARB memory size than B11 (see data sheet). But apart from the memory size, both options have the same functionality and are installed alternatively.

In the case of two-path instruments, at least one more option, the Baseband Generator (B10/B11) is required to generate a IEEE 802.11a-g WLAN signal in the second path. With this option, a IEEE 802.11a-g WLAN signal can be defined on path B and then either be routed to path A or added to the path A signal with a settable frequency offset. Generating the IEEE 802.11a-g WLAN signal simultaneously on paths A and B requires an additional, second option, the (Digital Standard IEEE 802.11a-g WLAN (K48). With a full path B configuration with a second option (Baseband Main Module (B13) and an RF section (frequency option B20x), the IEEE 802.11a-g WLAN signal can be output at RF output B.

'IEEE 802.11' stands for a wireless LAN standard prepared by ANSI/IEEE Institute of Electrical and Electronics Engineers). A brief description of the standard is given in the following. For a detailed description see the corresponding ANSI/IEEE specifications.

In 1990, IEEE founded the work group 802.11 which issued a first version of the 802.11 standard in June 1997. This standard defines two transmission methods: an infrared interface and radio transmission in the ISM band around 2.4 GHz.

Radio transmission can alternatively be carried out via frequency hopping spread spectrum (FHSS) or direct sequence spread spectrum (DSSS).

Originally, two data transmission modes were defined for the DSSS method.

- 1 Mbps data rate with DBPSK modulation
- 2 Mbps data rate with DQPSK modulation

Both modes spread the information data sequence with an 11-chip Barker sequence, and operate with a chip rate of 11 Mcps.

In spring 1999, the standard was extended by an OFDM mode, 802.11a, in the 5 GHz band. Soon afterwards, in summer 1999, the DSSS mode was extended, too. This expansion to include the new data rates of 5.5 Mbps and 11 Mbps is defined in the 802.11b standard. A new modulation mode, complementary code keying (CCK), was introduced (see following sections).

Standard 802.11g issued in 2003 extends standard 802.11b with higher transmission rates. It includes the previous 802.11b standard and implements the OFDM transmission of standard 802.11a in the 2.4 GHz ISM band. In the physical layer, the packet structure and modulation format of the OFDM modes are identical in 802.11g and 802.11a, only different transmission frequencies are used.

The 802.11 wireless LAN standard is a packet-oriented method for data transfer. The data packets are transmitted and received on the same frequency in time division duplex (TDD), but without a fixed timeslot raster. An 802.11 component can only transmit or only receive packets at any particular time.



The R&S Vector Signal Generator simulates IEEE 802.11a-g WLAN at the physical on the physical layer. Two simulation modes are offered:

In the framed mode a sequence of data packets with the frame structure defined by the standard is generated. A MAC header and a frame check sequence can be activated. In the unframed time mode a non-packet-oriented signal without frame structure is generated, with the modulation modes and data rates defined by the IEEE 802.11.

The following list gives an overview of the options provided by the R&S Vector Signal Generator for generating a IEEE 802.11a-g WLAN signal:

- Physical Layer modes OFDM (IEEE.802.11a/g), and CCK/PBCC (IEEE.802.11b/g).
- Chip/Sample rate 20 Mcps (OFDM IEEE.802.11a/g), and 11 Mcps (CCK/PBCC IEEE.802.11b/g).
- PSDU bit rates 1Mbps, 2Mbps, 5.5Mbps and 11 Mbps (CCK/PBCC), 22Mbps (PBCC), 6 Mbps, 9 Mbps, 12 Mbps, 18 Mbps, 24Mbps, 36 Mbps, 48 Mbps and 54 Mbps (OFDM).
- PSDU Modulation DBPSK,DQPSK and CCK/PBCC (CCK/PBCC) and BPSK,QPSK,16QAM or 64QAM (OFDM) (depending on specified PSDU bit rate).
- Data scrambling can be activated or deactivated (CCK/PBCC) and initial scrambler state can be set randomly or to a user-defined value (OFDM).
- Clipping for reducing the crest factor.

## Physical Layer OFDM

The standard defines OFDM (orthogonal frequency division multiplex) with 52 carriers as transmission method. The symbol rate of the modulation on the individual carriers is 250 kHz. A user data rate of up to 54 Mbps at a channel bandwidth of 20 MHz can be obtained by combining 48 useful carriers for data transmission (4 carriers are used for pilots) and using 64QAM for subcarrier modulation. With OFDM, the individual carriers are superimposed mutually orthogonal, which, in the ideal case, does not cause any intercarrier interference (ICI).

Table 4-28 Parameters of 802.11a/g OFDM modulation

Parameters	Value
Number of data subcarriers	48
Number of pilot subcarriers	4
Total of subcarriers used	52
Subcarrier frequency spacing	0.3125 MHz (= 20 MHz/64)
IFFT/FFT period	3.2 $\mu$ s
Guard interval duration	0.8 $\mu$ s (TFFT /4)
Symbol interval	4 $\mu$ s (TGI + TFFT )
PLCP preamble duration	16 $\mu$ s
Subcarrier modulation	BPSK OFDM QPSK OFDM 16QAM OFDM 64QAM OFDM
Error correction code	K = 7 (64 states) convolutional code
Code rates	1/2, 2/3, 3/4
Occupied bandwidth	16.6 MHz
Channel spacing	20 MHz

The table shows the main parameters of OFDM. 64-point IFFT is used to generate the 52 subcarriers. 12 of the 64 possible carriers are not used. One is the carrier in the middle of the band, which would otherwise be impaired by the carrier leakage of the I/Q modulator, the others are the remaining carriers at the upper and lower end of the spectrum. The required subcarrier offset of 312.5 kHz is implicitly observed when the time signal generated by the IFFT with a sampling rate of 20 MHz is output. These 20 MHz are also called 'kernel sample rate'. An OFDM symbol generated in this way would have a period of 3.2 μs. To compensate for multipath propagation, a so-called guard interval with a duration of 0.8 μs is attached to each symbol so that a total symbol interval of 4 μs is obtained.

Either BPSK, QPSK, 16QAM or 64QAM modulation can be used on the subcarriers. Prior to the modulation, the raw data are convolutionally coded with code rates of 1/2 to 3/4 being possible.

The frame structure can be seen in the figure below (also indicated in the **PPDU Configuration** submenu):

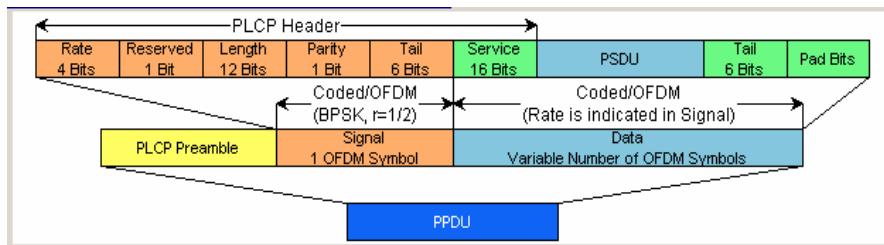

**PLCP Format**

The physical layer convergence protocol (PLCP) is a protocol layer between medium access control and the actual physical transmission layer (PHY). It is mainly used to adapt the different transmission formats of the 802.11 standards to the MAC layer which is identical for all transmission methods. Moreover, this protocol informs the receiver on the type of signal sent to allow for a correct demodulation.

The PLCP generates the PLCP protocol data unit (PPDU) frames which are physically transmitted.

**PLCP Preamble**

Each frame starts with the PLCP preamble made up of 10 short and 2 long symbols. The receiver uses the short symbols mainly for signal detection, AGC, coarse frequency adjustment and time synchronization. The long symbols are used to determine the transmission function of the channel and to set the equalizer of the receiver accordingly. The complete preamble is 16 μs long and thus corresponds to the duration of 4 normal OFDM symbols.

**Signal Field**

The signal field directly follows the preamble and consists of 24 bits which are used as follows:

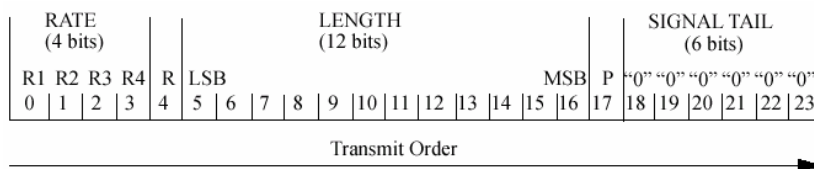

The first 4 bits inform on the data rate (RATE) of the following data section. This allows the receiver to correctly set its demodulator. Following a reserved bit, 12 LENGTH bits are sent. They contain the number of bytes transmitted in this frame. After a parity bit, 6 tail bits reset the convolutional coder to zero.

With settings for 6 Mbps, the 24 bits are subjected to usual signal processing consisting of convolutional coding, interleaving, BPSK subcarrier modulation, pilot carrier generation and OFDM modulation and thus form exactly one OFDM symbol of 4  $\mu$ s duration. Thanks to the use of the lowest data rate (6 Mbps), each receiver has the best chance to obtain the information required for subsequent demodulation of the data section.

### User Data

The user data in the data section of the frame is finally taken to the receiver. The data section may have a variable length of OFDM symbols and can be transmitted with one of the defined data rates between 6 and 54 Mbps. The data section of the frame is subdivided into the fields SERVICE, PSDU, TAIL and Pad bits.

SERVICE 16 Bits	PSDU	TAIL 6 Bits	Pad Bits
--------------------	------	----------------	-------------

The service field consists of 16 bits, the 7 LSBs transmitted first being 0. This allows the receiver to draw conclusions as to the start value of the scrambler in the transmitter. The remaining 9 bits are reserved and, according to the current version of the standard, should also be set to 0.

The PSDU may have a user-selectable length of up to 2346 bytes. 6 tail bits follow to reset the convolutional coder to zero. The data field must be filled with the full number of OFDM symbols and is therefore rounded up. Additional bits that may be available are set to 0 as pad bits.

A short description of the individual steps required to attain a valid 802.11a/g signal follows.

Data from the source (usually the next higher protocol layer, here MAC) must first be scrambled, i.e. multiplied with a PN sequence. A 127-bit code generated by the following generator polynomial is stipulated:

$$S(x) = x^7 + x^4 + 1$$

A feedback shift register generates the scrambling sequence. The start value of the register for the data section should be randomly selected.

A subsequent convolutional coder adds redundancies to the bits thus scrambled (factor of 2). The coder has 64 possible states ( $k = 7$ ) and is described by the polynomials  $g_0=133_8$  and  $g_1=171_8$ . To obtain the data rates of 6 to 54 Mbps defined by the standard, different channel code rates are required. Bits generated by the convolutional coder are therefore punctured (i.e. omitted) depending on the setting so that 1/2, 2/3 or 3/4 code rates are attained. Increasing the redundancy by channel coding is generally mandatory in case of OFDM modulations since complete subcarriers may be eliminated by frequency selective fading so that the loss of bits on the transmission path is in many cases unavoidable.

To increase the performance of the convolutional coder, the coded data are interleaved in the next step. Two interleaver stages ensure that the adjacent bits of the convolutional coder are first distributed to different subcarriers and then to higher- or lower-significant bits of the constellation used for subcarrier modulation. Long sequences of defective bits can thus be avoided which significantly improves the faculties of the Viterbi decoder in the receiver for a correction.

The next stage performs the actual modulation of the individual OFDM carriers. Depending on the set data rate, the useful carriers are subjected to a uniform BPSK, QPSK, 16QAM or 64QAM modulation. This is done by first calculating the I and Q coefficients of each carrier. Gray coding is used to distribute the data bits to constellation points. All carriers from -26 to +26, except carriers -21, -7, 0, 7 and 21, are used for the transmission of user data. Carrier number 0 (directly at the center frequency later on) is not used and is always 0. The remaining 4 are BPSK-modulated pilots. The pilot carriers change their phase with each symbol. The phase variation is determined by the 127-bit PN sequence already defined as scrambling sequence.

The actual OFDM modulation is performed by inverse discrete Fourier transform (IFFT) in the next step. A 64-point IFFT is carried out with the I and Q coefficients of the subcarriers obtained before. To ensure sufficient spacing of aliasing products, only 52 of the 64 possible carriers are used. The result is a discrete complex time signal in the baseband with modulated OFDM carriers. A guard field which corresponds to a periodic continuation of the same symbol is then appended before each OFDM symbol. Multipath propagation can thus be easily compensated in the receiver.

Aliasing products are suppressed by oversampling, converting the discrete digital signal to an analog signal and subsequent filtering. In the last step, the baseband signal is modulated onto the selected RF carrier and the complete signal is sent to the receiver via the air interface.

## Physical Layer CCK-PBCC

A distinction is made between the packet type (or PPDU format) with long or short PLCP (physical layer convergence protocol).

### Long PLCP PPDU Format

In 802.11, the data packet on the physical layer is referred to as PPDU (PLCP protocol data units). A PPDU consists of three components; the PLCP preamble, the PLCP header and the PSDU (PLCP service data unit), which contains the actual information data (coming from higher layers).

The PLCP preamble and header are used for synchronization and signalling purposes, and are themselves divided into fields.

The **PLCP preamble** consists of a synchronization field and a start frame delimiter field. The standard specifies a fixed data content for both fields.

The **PLCP header** consists of the signal, service, length and CRC fields.

The signal field determines the data rate used in the PSDU field. The rates 1 Mbps, 2 Mbps, 5.5 Mbps, and 11 Mbps can be selected; rates 22 MBps and 33 Mbps can be used in the optional PBCC modes.

The service field also helps to differentiate the modulation modes (CCK or PBCC) used for the higher data rates of 5.5 Mbps and 11 Mbps.

The length of the PSDU field is entered in  $\mu$ s in the Length field.

The CRC field contains a check sum of all the fields of the PLCP header.

The PLCP preamble and the PLCP header in the long PLCP PPDU format are both DBPSK-modulated and transmitted at a data rate of 1 Mbps. The data rate and the modulation of the PSDU component are defined by the signal and service fields in the PLCP header.

The frame structure can be seen in the figure below (also indicated in the **PPDU Configuration** submenu):

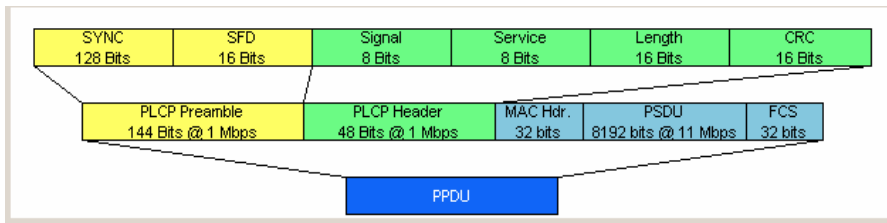

**Short PLCP PDU Format**

The basic structure of the short PLCP PDU format is identical to that of the long PLCP PDU format. There is no difference in the PSDU component. The PLCP preamble and header are generated in an abbreviated form. In the short preamble, the number of bits transmitted in the SYNC field is reduced from 128 to 56. In the short header, however, the number of data bits transmitted remains unchanged, but the data rate is doubled (to 2 Mbps). These measures halve the transmission periods of preamble and header in the short PLCP format, as compared to the long PLCP format.

The frame structure can be seen in the figure below (also indicated in the **PPDU Configuration** submenu):

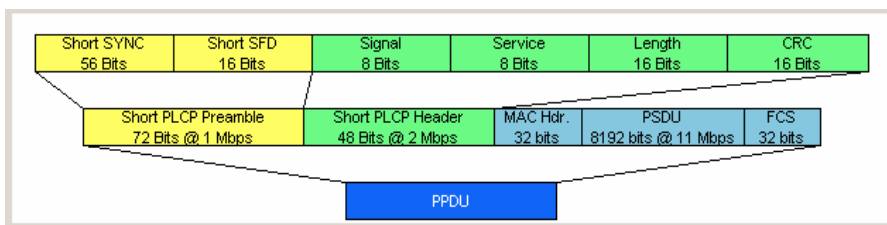

**Data Spreading and Modulation CCK-PBCC**

The Vector Signal Generator simulates signals in accordance with 802.11 on the physical layer. In the standard, the data link layer or, to be more precise, the MAC sublayer provides the input data for this layer. The following graph illustrates the signal generation process.

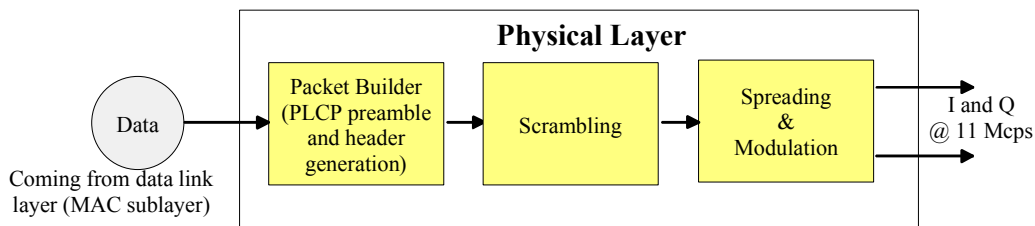

Fig. 4-56 Principle of 802.11b/g signal generation

Depending on the PLCP PDU format used, the PLCP preamble and the PLCP header are combined in the packet builder. The PSDU field of the packet is filled with the input data of the physical layer block. In the next step, all the packet data is scrambled. The actual spreading and modulation of the data signal to the resulting chip rate of 11 Mcps comes next.

However, the data rates and modulations of the individual fields of a packet can differ. The PLCP preamble always has a data rate of 1 Mbps, and is DBPSK-modulated. Besides the actual modulation, spreading to the resulting chip rate occurs.

The PLCP header is either treated exactly like the preamble (long PLCP PPDU format), or DQPSK-modulated at a data rate of 2 Mbps (short PLCP PPDU format). Data rates (1 Mbps, 2 Mbps, 5.5 Mbps, 11 Mbps, etc) with different modulations can be used for the data part of the packet, the PLCP service data unit (PSDU). The following table gives an overview of the different combinations of data rates, modulations and spreading/coding methods.

Packet field	Data rate	Chip rate	Spreading/coding methods	Modulation
Short PLCP preamble	1 Mbps	11 Mcps	11-chip Barker sequence	DBPSK
Long PLCP preamble	1 Mbps	11 Mcps	11-chip Barker sequence	DBPSK
Short PLCP header	2 Mbps	11 Mcps	11-chip Barker sequence	DQPSK
Long PLCP header	1 Mbps	11 Mcps	11-chip Barker sequence	DBPSK
PSDU	1 Mbps (long PPDU)	11 Mcps	11-chip Barker sequence	DBPSK
PSDU	2 Mbps	11 Mcps	11-chip Barker sequence	DQPSK
PSDU	5.5 Mbps	11 Mcps	CCK	DQPSK
PSDU	11 Mbps	11 Mcps	CCK	DQPSK
PSDU	5.5 Mbps	11 Mcps	PBCC	BPSK
PSDU	11 Mbps	11 Mcps	PBCC	QPSK
PSDU	22 Mbps	11 Mcps	PBCC	8PSK
PSDU	33 Mbps	16.5 Mcps	PBCC	8PSK

The individual combinations of spreading, coding and modulation are described below.

### 1 Mbps Data Rate with DBPSK Modulation

At a data rate of 1 Mbps, the already scrambled data stream is DBPSK-modulated according to the table below. The resulting symbol sequence is then spread using the 11-chip Barker sequence.

Bit input	Phase change (+j $\omega$ )
0	0
1	$\pi$

### 2 Mbps Data Rate with DQPSK Modulation

At a data rate of 2 Mbps, the already scrambled data stream is DQPSK-modulated according to the table below. The resulting symbol sequence is then spread using the 11-chip Barker sequence.

Dibit pattern (d0,d1) (d0 is first in time)	Phase change (+j $\omega$ )
00	0
01	$\pi/2$
11	$\pi$
10	$3\pi/2$ ( $-\pi/2$ )

### 5.5 Mbps Data Rate with CCK Modulation

The standard specifies CCK modulation (complementary code keying) for a data rate of 5.5 Mbps. To this end, in each modulation step, four successive bits ( $d_0$  to  $d_3$ ) are taken from the data stream which is already scrambled. The phases  $\phi_1, \phi_2, \phi_3, \phi_4$  are determined by these four bits.  $\phi_1$  is determined by the data bits  $d_0$  and  $d_1$  according to the following table, which specifies different phases for even and odd modulation steps:

Dibit pattern (d0, d1) (d0 is first in time)	Even symbols phase change (+j $\omega$ )	Odd symbols phase change (+j $\omega$ )
00	0	$\pi$
01	$\pi/2$	$3\pi/2$ ( $-\pi/2$ )
11	$\pi$	0
10	$3\pi/2$ ( $-\pi/2$ )	$\pi/2$

The phase  $\varphi_1$  must be interpreted relative to the phase of the previous symbol.

The other three phases are determined as follows:

$$\varphi_2 = (d_2 \cdot \pi) + \pi / 2$$

$$\varphi_3 = 0$$

$$\varphi_4 = d_3 \cdot \pi$$

By means of these four phases, the CCK code word can now be determined; it is:

$$c = \{e^{j(\varphi_1 + \varphi_2 + \varphi_3 + \varphi_4)}, e^{j(\varphi_1 + \varphi_3 + \varphi_4)}, e^{j(\varphi_1 + \varphi_2 + \varphi_4)}, \\ -e^{j(\varphi_1 + \varphi_4)}, e^{j(\varphi_1 + \varphi_2 + \varphi_3)}, e^{j(\varphi_1 + \varphi_3)}, -e^{j(\varphi_1 + \varphi_2)}, e^{j\varphi_1}\}$$

Example:

(d<sub>0</sub> to d<sub>3</sub>) = (0110), the phase of the last symbol is 0, the current modulation step is even:

$$\varphi_1 = \pi / 2$$

$$\varphi_2 = (1 \cdot \pi) + \pi / 2 = 3\pi / 2$$

$$\varphi_3 = 0$$

$$\varphi_4 = 0 \cdot \pi = 0$$

The CCK code word is consequently:

$$c = (e^{j(\pi/2+3\pi/2+0+0)}, e^{j(\pi/2+3\pi/2+0)}, e^{j(\pi/2+3\pi/2+0)}, -e^{j(\pi/2+0)}, e^{j(\pi/2+3\pi/2+0)}, e^{j(\pi/2+0)}, -e^{j(\pi/2+3\pi/2)}, e^{j\pi/2}, )$$

$$c = (e^{j0}, e^{j0}, e^{j0}, -e^{j\pi/2}, e^{j0}, e^{j\pi/2}, -e^{j0}, e^{j\pi/2}, ) = (1, 1, 1, -j, 1, j, 1, j, )$$

The four data bits (d<sub>0</sub> to d<sub>3</sub>) thus become the eight complex output chips (c<sub>0</sub> to c<sub>7</sub>).

## 11 Mbps Data Rate with CCK Modulation

The standard also specifies CCK modulation (complementary code keying) for a data rate of 11 Mbps. The modulation is basically the same as described for the 5.5 Mbps data rate. In each modulation step, eight successive bits (d<sub>0</sub> to d<sub>7</sub>) are taken from the data stream, which is already scrambled. The phases  $\varphi_1, \varphi_2, \varphi_3, \varphi_4$  are determined by these eight bits.

$\varphi_1$  is determined by the data bits d<sub>0</sub> and d<sub>1</sub> according to the following table, which specifies different phases for even and odd modulation steps:

Dibit pattern (d0, d1) (d0 is first in time)	Even symbols phase change (+j $\omega$ )	Odd symbols phase change (+j $\omega$ )
00	0	$\pi$
01	$\pi/2$	$3\pi/2$ ( $-\pi/2$ )
11	$\pi$	0
10	$3\pi/2$ ( $-\pi/2$ )	$\pi/2$

The phase  $\phi_1$  must be interpreted relative to the phase of the previous symbol.

$\phi_2$  is determined by the data bits  $d_2, d_3, \phi_3$  from  $d_4, d_5$  and  $\phi_2$  from  $d_6, d_7$  according to the following table:

Dibit pattern [di, d(i+1)] (di is first in time)	Phase
00	0
01	$\pi/2$
10	$\pi$
11	$3\pi/2$ ( $-\pi/2$ )

**5.5 Mbps and 11 Mbps Data Rates with PBCC Modulation**

Packet binary convolutional coding (PBCC) can optionally be used instead of CCK modulation for the 5.5 Mbps and 11 Mbps data rates. The following illustration provides a schematic overview of this method. For details, refer to the standard.

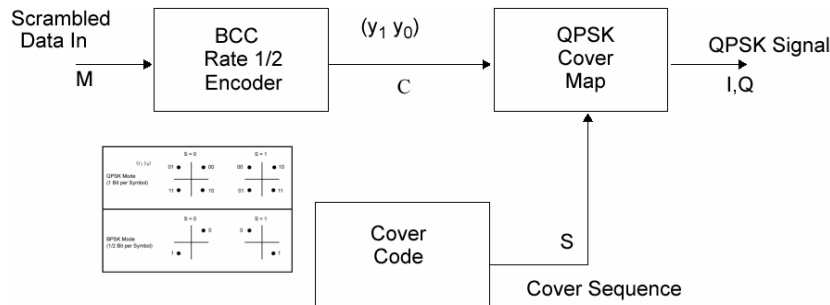

Fig. 4-57 Principle of PBCC modulation

**22 Mbps and 33 Mbps Data Rates with PBCC Modulation**

802.11g also defines the optional PBCC (ER-PBCC) modes using the extended 22 Mbps and 33 Mbps rates (see [3], 19.3.3.2). In contrast to the 5.5 Mbps and 11 Mbps PBCC modes, a rate 2/3 convolutional coder and 8PSK modulation are used. With 33 Mbps, also the clock rate in the data section of the packet is increased to 16.5 Mcps.



# WLAN Menu

The menu for setting the IEEE 802.11a-g WLAN digital standard is either called from the baseband block or from the menu tree under Baseband.

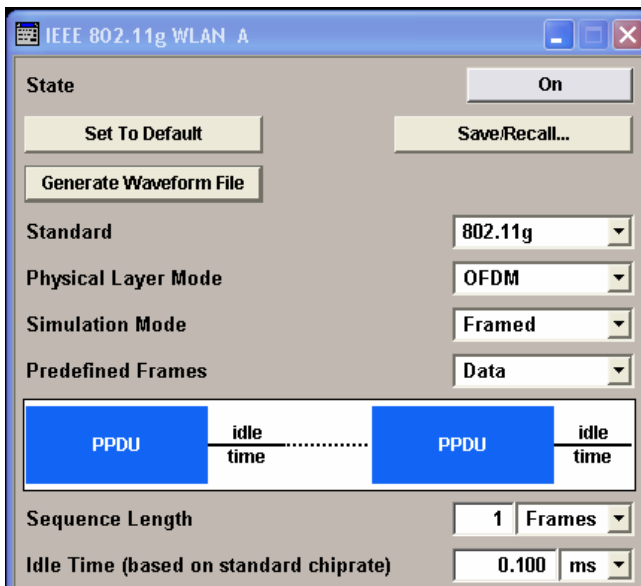
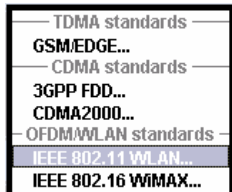

The upper section of the menu is where the IEEE 802.11a-g WLAN digital standard is enabled, the default settings are called and the physical layer mode, the simulation mode and the frame type are selected. Additional parameters for defining the signal length and a graph outlining the signal structure are indicated.

A button leads to the submenu for loading and saving the IEEE 802.11a-g WLAN configuration.

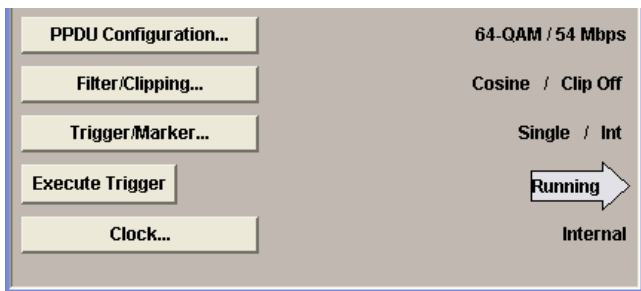

The buttons of the lower menu section lead to submenus for configuring the PPDU and for setting the filter, clipping, trigger and clock parameters.

## General Settings for WLAN Signals

The upper menu section is where the IEEE 802.11a-g WLAN digital standard is enabled and the basic signal structure is configured.

### State - WLAN

Enables/disables the IEEE 802.11a-g WLAN standard.

Enabling this standard disables all the other digital standards and digital modulation modes on the same path.

Remote-control command:

SOUR:BB:WLAN:STAT ON

### Set to default - WLAN

Calls the default settings . The following table gives an overview of the settings. The preset value for each parameter is specified in the description of the remote-control commands.

Remote-control command:

SOUR:BB:WLAN:PRES

Parameter	Value
State	Not affected by Set to default
Standard	802.11g
Physical Layer Mode	CCK
Simulation Mode	Framed
Predefined Frames	Data
Sequence Length	1 frame
Idle Time	0.1 ms
Filter	Gauss (FSK), 0.50
Chip Rate Variation	11 Mcps
Clipping	Off
PPDU Configuration (CCK)	
PLCP P+H Format	Long PLPC
PSDU Bit Rate (CCK/PBCC)	11 Mbps
Data Length	1024 bytes
PSDU Data Source	PRBS 9
Scrambling	On
Service Field Clock Bits	Locked
MAC Header	Off
FCS (checksum)	Off

**Save/Recall - WLAN**

Calls the **Save/Recall** menu.

From the **Save/Recall** menu the **File Select** windows for saving and recalling IEEE 802.11a-g WLAN configurations and the **File Manager** can be called.



IEEE 802.11a-g WLAN configurations are stored as files with the predefined file extension **\*.wlan**. The file name and the directory they are stored in are user-definable.

The complete settings in the **IEEE 802.11a-g WLAN** menu are saved and recalled.

**Recall IEEE 802.11a-g WLAN setting**

Opens the **File Select** window for loading a saved IEEE 802.11a-g WLAN configuration.

The configuration of the selected (highlighted) file is loaded by pressing the **Select** button.

Remote-control command:

```
MMEM:CDIR 'F:\gen_lists\wlan'
```

```
SOUR:BB:WLAN:SETT:CAT?
```

```
Response: 'wlan_1',wlan_2'
```

```
SOUR:BB:WLAN:SETT:LOAD "wlan_1"
```

**Save IEEE 802.11a-g WLAN setting**

Opens the **File Select** window for saving the current IEEE 802.11a-g WLAN signal configuration.

The name of the file is specified in the **File name** entry field, the directory selected in the **save into** field. The file is saved by pressing the **Save** button.

Remote-control command:

```
MMEM:CDIR 'F:\gen_lists\wlan'
```

```
SOUR:BB:WLAN:SETT:STOR 'wlan_3'
```

**File Manager**

Calls the **File Manager**.

The **File Manager** is used to copy, delete and rename files and to create new directories.

Remote-control commands:

```
MMEM:CDIR 'F:\gen_lists\wlan'
```

```
SOUR:BB:WLAN:SETT:DEL 'wlan_1'
```

**Generate Waveform File... - WLAN** - Calls the **Generate Waveform** menu. This menu is used to store the current TD-SCDMA signal as ARB signal in a waveform file.

This file can be loaded in the **ARB** menu and processed as multicarrier or multisegment signal.

The file name is entered in the submenu. The file is stored with the predefined file extension **\*.wv**. The file name and the directory it is stored in are user-definable.

Remote-control commands:

```
SOUR:BB:WLAN:WAV:CRE "c:\temp\wlan.wv"
```

## Standard - WLAN

Selects the 802.11 standard.

The standard was expanded over the years adding additional features.

**802.11a** The standard supports OFDM (orthogonal frequency division multiplexing). This modulation is defined by the IEEE 802.11a specification in the 5 GHz frequency band.

Remote-control command:

```
SOUR:BB:WLAN:STAN STAN80211A
```

**802.11b** The standard includes the modulation mode CCK (complementary code keying) and the data rates 5.5 Mbps and 11 Mbps. PBCC (packet binary convolutional coding) can optionally be used instead of CCK modulation for the 5.5 Mbps and 11 Mbps data rates.

Remote-control command:

```
SOUR:BB:WLAN:STAN STAN80211B
```

**802.11g** Standard 802.11g extends standard 802.11b with higher transmission rates. 802.11g contains the previous 802.11b modes and also integrates the OFDM method used in 802.11a for frequencies in the 2.4 GHz band.

Remote-control command:

```
SOUR:BB:WLAN:STAN STAN80211G
```

**Physical Layer Mode - WLAN**

Selects the physical layer mode.

**OFDM**

The OFDM (orthogonal frequency division multiplexing) physical layer supports a frame-based transmission. The OFDM signal is divided into 52 carriers. The symbol rate of the modulation on the individual carriers is 250 kHz. A user data rate of up to 54 Mbps at a channel bandwidth of 20 MHz can be obtained by combining 48 useful carriers for data transmission (4 carriers are used for pilots) and using 64QAM for subcarrier modulation. With OFDM, the individual carriers are superimposed mutually orthogonal, which, in the ideal case, does not cause any intercarrier interference (ICI).

Remote-control command:

```
SOUR:BB:WLAN:MODE OFDM
```

**CCK**

The CCK (complementary code keying) physical layer mode is used for the 5.5 Mbps and 11 Mbps data rates.

Remote-control command:

```
SOUR:BB:WLAN:MODE CCK
```

**PBCC**

The PBCC (packet binary convolutional coding) physical layer can optionally be used instead of CCK modulation and extends 802.11b to higher data rates (22 Mbps).

Remote-control command:

```
SOUR:BB:WLAN:MODE PBCC
```

**Simulation Mode - WLAN**      Selects the simulation mode.

### Framed

The **framed mode** is the standard operating mode which is also used in the real system. Data packets with the frame structure defined by the standard are generated.

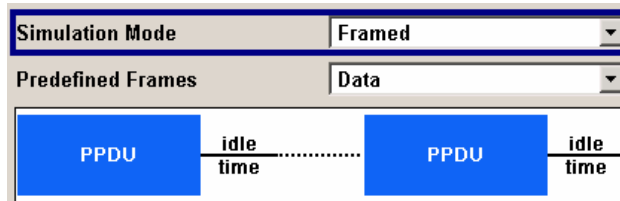

Signals representing a sequence of frames (PLCP protocol data units, referred to as PPDUs) and separated by a so-called idle time can be configured in the framed mode. The user data is continued in the consecutive frames, i.e. it is not repeated in each frame. Both the duration of the idle time and the number of frames to be sent can be user-selected.

Remote-control command:

SOUR:BB:WLAN:SMOD FRAM

### Unframed

The **unframed mode** is offered in addition. In this mode, a non-packet-oriented signal without a frame structure is generated with the modulations and data rates defined by 802.11a-g. This mode can be used for simple tests for which only modulation and spectrum of the test signal are of interest.

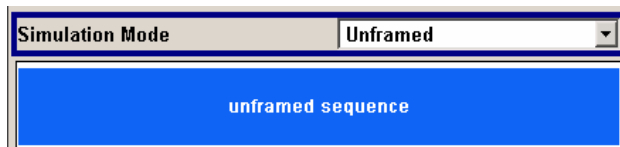

No PLCP preamble and no signal field are generated in the unframed mode. The idle time is also omitted. The data field is identical to that of the framed mode and also contains the service and tail bits. The length limitation stipulated by the standard to the maximum PSDU block length of 4095 bytes in the framed mode does not apply.

Operation is the same as in the framed mode, but only a limited number of setting parameters is available.

Remote-control command:

SOUR:BB:WLAN:MODE UNFRM

**Predefined Frames - WLAN** (Framed Mode only) Selects the frame type. The selection defines parameters of the MAC layer, e.g. the type and sub-type bit fields of the MAC Header.

<b>Data</b>	Frames containing useful data. Remote-control command: SOUR:BB:WLAN:FFOR DATA
<b>RTS</b>	Request to Send. Remote-control command: SOUR:BB:WLAN:FFOR RTS
<b>CTS</b>	Clear to Send. Remote-control command: SOUR:BB:WLAN:FFOR CTS
<b>ACK</b>	Acknowledgement. Remote-control command: SOUR:BB:WLAN:FFOR ACK

**Sequence Length - WLAN** Sets the sequence length of the signal in number of frames. A (physical layer) frame consists of a PPDU burst including the subsequent idle time.

Remote-control command:  
SOUR:BB:WLAN:FCO 20

**Idle time - WLAN**

(based on standard chip rate)

**(This feature is available for Framed Mode only).**

Sets the idle time, i.e. the time between two PPDU bursts. Idle time is given in  $\mu\text{s}$ ; the packets can also be joined to each other directly with idle time 0. Please note that the idle time refers to the chip rate as defined in the standard (11 Mcps for 802.11b/g CCK/PBCC and 20 Mcps for 802.11a/g OFDM). Only at this chip rate does the idle period correspond exactly to the time set. If the chip rate is doubled, for instance, the real idle time is halved.

Remote-control command:  
SOUR:BB:WLAN:ITIM 10 ms

<b>PPDU Configuration - WLAN</b>	<p><b>(This feature is available for Framed Mode only)</b></p> <p>Calls the menu for configuration of the PPDU. The menu differs for the physical layer modes.</p> <p>The menu is described in Section "<a href="#">PPDU/Sequence Configuration - WLAN</a>", Page 4.629.</p> <p>Remote-control command: n.a.</p>
<b>Sequence Configuration - WLAN</b>	<p><b>(This feature is available for Unframed Mode only).</b></p> <p>Calls the menu for configuration of the signal in unframed mode modes.</p> <p>The menu is described in Section "<a href="#">PPDU/Sequence Configuration - WLAN</a>", Page 4.629.</p> <p>Remote-control command: n.a.</p>
<b>Filter, Clipping - WLAN</b>	<p>Calls the menu for setting the filter parameters and the clipping. The current setting is displayed next to the button.</p> <p>The menu is described in Section "<a href="#">Filter, Clipping - WLAN</a>", Page 4.337.</p> <p>Remote-control command: n.a.</p>
<b>Trigger - Marker - WLAN</b>	<p>Calls the menu for selecting the trigger source, for configuring the marker signals and for setting the time delay of an external trigger signal (see Section "<a href="#">Trigger/Marker/Clock - 3GPP FDD</a>", Page 4.332).</p> <p>The currently selected trigger source is displayed to the right of the button.</p> <p>Remote-control command: n.a.</p>
<b>Execute Trigger - WLAN</b>	<p><b>This feature is available for Trigger Source Internal only.</b></p> <p>Executes trigger manually.</p> <p>A manual trigger can be executed only when an internal trigger source and a trigger mode other than <b>Auto</b> have been selected.</p> <p>Remote-control commands:</p> <pre>SOUR:BB:WLAN:TRIG:SOUR INT SOUR:BB:WLAN:SEQ RETR SOUR:BB:WLAN:TRIG:EXEC</pre>
<b>Clock - WLAN</b>	<p>Calls the menu for selecting the clock source (see Section "<a href="#">Trigger/Marker/Clock - 3GPP FDD</a>", Page 4.332").</p> <p>Remote-control command: n.a.</p>



## PPDU/Sequence Configuration - WLAN

In **framed mode**, a frame consists of a PPDU (PLCP protocol data unit) and the idle time. The data packet on the physical layer is referred to as PPDU. A PPDU consists of three components; the PLCP preamble, the PLCP header and the PSDU (PLCP service data unit), which contains the actual information data (coming from higher layers).

The PLCP preamble and header are used for synchronization and signaling purposes, and are themselves divided into fields.

The details of the PPDU structure depend on the selected standard or, more precisely, on the physical layer mode (see below).

In **unframed mode**, the signal can be configured via the **PSDU bit rate** and **PSDU modulation** parameters, just as in the Framed mode. However, a preamble or header is not generated; only a continuous PSDU block is generated, the length of which can be varied by using the **Sequence Length** parameter. There is no restriction of the maximum PSDU block length to 4095 bytes as in the Framed mode. Moreover, the data stream can be scrambled prior to the modulation (**Scrambling Mode** parameter).

### Standard 802.11a - OFDM

In the upper section of the menu, the parameters of the data part (PSDU) are set. In the middle section, the parameters of the scrambler and interleaver are set. A graph in the lower sections illustrates the structure of the PPDU (framed mode) or the unframed sequence (unframed mode).

Framed mode:

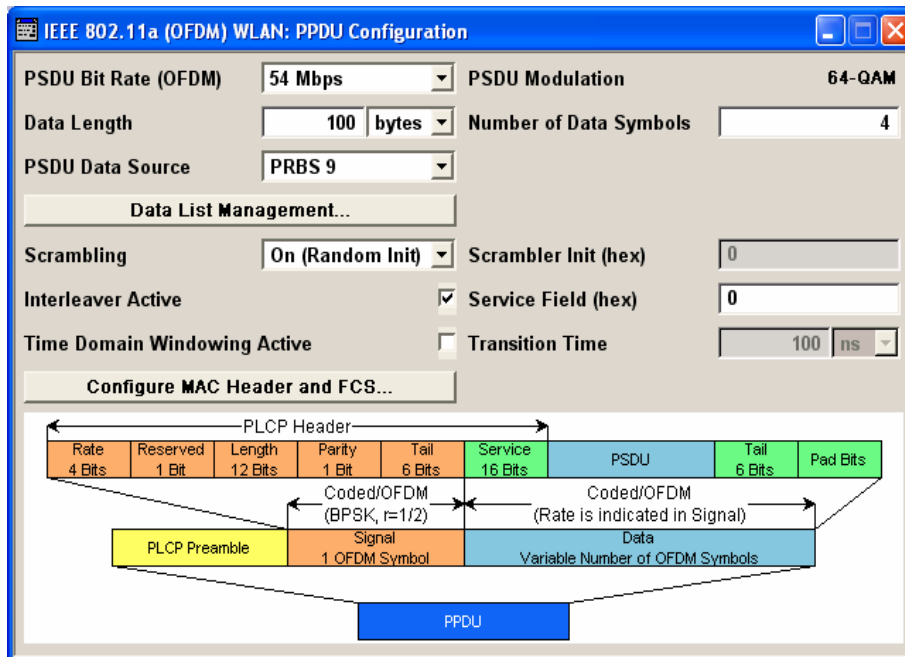

Unframed mode:

### Standard 802.11b/g - CCK - PBCC

In the upper section of the menu, the parameters of the data part (PSDU) are set. In framed mode, a distinction is made between the packet type (or PPDU format) with long or short PLCP (physical layer convergence protocol). A graph in the lower sections illustrates the structure of the PPDU (framed mode) or the unframed sequence (unframed mode).

Framed Mode:

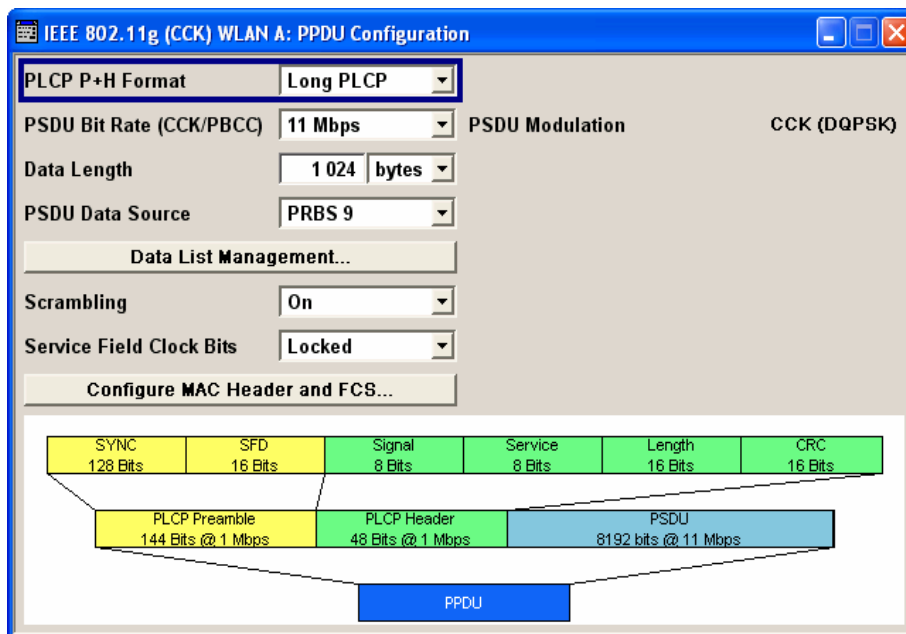

Unframed Mode:

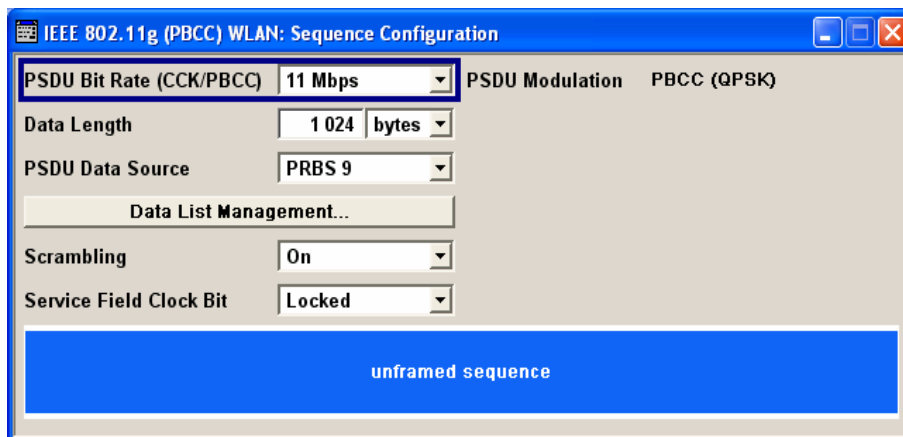

### PLCP P+H Format (CCK,PBCC) - WLAN

(framed mode) Selects the packet type (PPDU format) with long or short PLCP (physical layer convergence protocol) . Depending on the format selected, the structure, modulation and data rate of the PLCP preamble and header are modified. The format currently set is shown in the graphic display in the lower part of the menu.

See section "[Physical Layer CCK-PBCC](#)", on page 4.616 for description of the long and short format

Remote-control command:

```
SOUR:BB:WLAN:PLCP:FORM LONG
```

**PSDU Bit Rate - WLAN**

(OFDM) Selects the bit rate of the PSDU.

All data rates defined by the standard are supported. The selection of the PSDU bit rate automatically determines the code rate of the convolutional coder and the subcarrier modulation of the OFDM.

Remote-control command:

SOUR:BB:WLAN:PSDU:BRAT 18MBPS

**PSDU Bit Rate**

(CCK,PBCC) Selects the bit rate of the PSDU.

The data rates available are 1 Mbps, 2 Mbps, 5.5 Mbps, 11 Mbps and 22 Mbps. The 1 Mbps data rate is only available if the long PLCP format has been selected (framed mode only). The selection of the data rate also determines the possible modulation modes. The following table shows the correlation between data rate and modulation:

Remote-control command:

SOUR:BB:WLAN:PSDU:BRAT 18MBPS

Data rate	Possible modulation mode
1 Mbps	Barker Sequence (DBPSK) the information data sequence is spread with an 11-chip Barker sequence, chip rate is 11 Mcps
2 Mbps	Barker Sequence (DQPSK) the information data sequence is spread with an 11-chip Barker sequence, chip rate is 11 Mcps
5.5 Mbps	CCK (DQPSK) or PBCC (BPSK)
11 Mbps	CCK (DQPSK) or PBCC (QPSK)
22 Mbps	PBCC (8PSK)

**PSDU Modulation - WLAN**

(OFDM) Indicates the modulation type used on the OFDM subcarriers. The modulation mode depends on the selected PSDU bit rate.

Remote-control command:

SOUR:BB:WLAN:PSDU:MOD QAM16

**PSDU Modulation**

(CCK,PBCC) Indicates the modulation type. The modulation mode depends on the selected PSDU bit rate. The **Physical Layer Mode** parameter in the main menu can be used for switchover between CCK and PBCC.

Remote-control command:

SOUR:BB:WLAN:PSDU:MOD DQPSK

**Data Length - WLAN**

Sets the data length.

In the framed mode, data field lengths of up to 4095 bytes per frame packet are possible. This corresponds to the maximum data length. If the MAC Layer is activated, the MAC header (up to 30) and the (4) FCS bytes are added.

The unframed mode offers a data length of up to 100000 bytes.

**OFDM:**

If the data field length is changed, the generator calculates the number of OFDM data symbols as a function of the set PSDU bit rate and displays it in the field **Number of Data Symbols**. Data is always rounded up to complete symbols. Free data bits in the last symbol, the so-called pad bits, are filled with 0.

Remote-control command:

```
SOUR:BB:WLAN:PSDU:DLEN 4095
```

**Number of Data Symbols (OFDM) - WLAN**

Sets the number of data symbols per frame packet.

If the number of OFDM data symbols is changed, the generator calculates the data field length as a function of the set PSDU bit rate and displays it at **Data Length**.

Remote-control command:

```
SOUR:BB:WLAN:PSDU:SCO 256
```

**PSDU Data SOURCE - WLAN**

Selects the data source for the data field. The following data sources are available:

**All 0**

0 data or 1 data is internally generated.

**All 1**

Remote-control command:

```
SOUR:BB:WLAN:PSDU:DATA ONE | ZERO
```

**PRBS****PRBS Type**

PRBS data in accordance with the IUT-T with period lengths between  $2^9-1$  and  $2^{23}-1$  are internally generated.

The length is selected in the **PRBS Type** input box.

Remote-control command:

```
SOUR:BB:WLAN:PSDU:DATA PN9
```

<b>Pattern</b>	A user-definable bit pattern with a maximum length of 64 bits is internally generated.
<b>Pattern</b>	The bit pattern is defined in the <b>Pattern</b> input box.
	Remote-control commands: <code>SOUR:BB:WLAN:PSDU:DATA PATT</code> <code>SOUR:BB:WLAN:PSDU:DATA:PATT</code> <code>#H77550,17</code>
<b>Data List</b>	Data lists will be used.
<b>...Select Data</b>	Data lists can be generated internally in the data editor or externally.
	Data lists are selected in the <b>File Select</b> window, which is called by means of the <b>Data List Management</b> button.
	The <b>File Manager</b> is used to transmit external data lists to the R&S Vector Signal Generator, and can be called within every File Select window by means of the <b>File Manager</b> button.
	Remote-control command: <code>SOUR:BB:WLAN:PSDU:DATA DLIS</code> <code>SOUR:BB:WLAN:PSDU:DATA:DLIS:SEL</code> <code>"d_11"</code>

**Data List Management... - WLAN**

Calls the **Data List Management** menu. This menu is used to create and edit a data list.

All data lists are stored as files with the predefined file extension **\*.dm\_iqd**. The file name and the directory they are stored in are user-definable.

The data lists must be selected as a data source from the submenus under the individual function, e.g. in the channel table of the cells.

Remote-control commands:

**Note:**

*All data lists are generated and edited by means of the SOURce:BB:DM subsystem commands. Files containing data lists usually end with \*.dm\_iqd. The data lists are selected as a data source for a specific function in the individual subsystems of the digital standard.*

Creating and editing the data list:

```
SOUR:BB:DM:DLIS:SEL "d_list1"
SOUR:BB:DM:DLIS:DATA #B1111010101000001111....
SOUR:BB:DM:DLIS:DATA:APP #B1111010101000001111....
```

Selecting the data list:

```
SOUR:BB:WLAN:PSDU:DATA DLIS
SOUR:BB:WLAN:PSDU:DATA:DLIS:SEL "d_11"
```

<b>Scrambler - WLAN</b>	(OFDM) Activates/deactivates the scrambler and selects the mode of determining the initialization value.
<b>OFF</b>	<p>The scrambler is deactivated.</p> <p>Remote-control command: SOUR:BB:WLAN:SCR:MODE OFF</p>
<b>Random</b>	<p>The scrambler is activated.</p> <p>The initialization value of the scrambler is selected at random. Each frame has a different random initialization value. This value is also different in case of successive recalculations with the same setting parameters so that different signals are generated for each calculation.</p> <p>Remote-control command: SOUR:BB:WLAN:SCR:MODE RAND</p>
<b>User</b>	<p>The scrambler is activated.</p> <p>The initialization value of the scrambler is set to a fixed value that is entered at <b>Scrambler Init (hex)</b> . This value is then identical in each generated frame.</p> <p>Remote-control command: SOUR:BB:WLAN:SCR:MODE USER</p>
<b>Scrambler (CCK,PBCC)</b>	<p>Activates or deactivates the scrambler. Some tests require a test signal without scrambling (e.g. for the RF carrier suppression measurement).</p>
<b>OFF</b>	<p>The scrambler is deactivated.</p> <p>Remote-control command: SOUR:BB:WLAN:SCR:MODE OFF</p>
<b>ON</b>	<p>The scrambler is activated.</p> <p>Remote-control command: SOUR:BB:WLAN:SCR:MODE ON</p>
<b>Preamble Only</b>	<p>The scrambler is activated.</p> <p>Only the preamble is scrambled.</p> <p>Remote-control command: SOUR:BB:WLAN:SCR:MODE PRE</p>

<b>Service Field Clock Bit (CCK,PBCC) - WLAN</b>	<p>Sets the Locked Clock Bit in Service Field of the PLCP Header.</p> <p>Via this flag (bit), the 802.11b/g transmitter indicates whether transmission frequency and symbol rate have been derived from the same oscillator. If this is the case (locked), the bit is set to 1, otherwise (not locked) to 0.</p> <p>Remote-control command: SOUR:BB:WLAN:PLCP:LCB:STAT ON</p>
<b>Disable Barker Spreading - WLAN</b>	<p>(CCK,PBCC) Activates/deactivates barker spreading (bit rates 1 Mbps or 2 Mbps only).</p> <p>Remote-control command: SOUR:BB:WLAN:PLCP:LCB:STAT ON</p>
<b>Scrambler Init (hex) (OFDM) - WLAN</b>	<p>Enters the initialization value for scrambling mode User. This value is then identical in each generated frame.</p> <p>Remote-control command: SOUR:BB:WLAN:SCR:PATT #H3F,8</p>
<b>Interleaver Active (OFDM) - WLAN</b>	<p>Activates/deactivates the interleaver.</p> <p>Remote-control command: SOUR:BB:WLAN:ILE ON</p>
<b>Service field (hex) - WLAN</b>	<p>Enters the value of the service field. The standard specifies a default value of 0. Other values can be entered in hexadecimal form for test purposes or future extensions.</p> <p>Remote-control command: SOUR:BB:WLAN:SERV:PATT #H3F,8</p>
<b>Time Domain Windowing Active - WLAN</b>	<p>Activates/deactivates the time domain windowing. Time domain windowing is a method to influence the spectral characteristics of the signal, which is not stipulated by the standard. However, it does not replace oversampling and subsequent signal filtering.</p> <p>Remote-control command: SOUR:BB:WLAN:TDW:STAT OFF</p>
<b>Transition Time - WLAN</b>	<p>Sets the transition time when time domain windowing is active.</p> <p>The transition time defines the overlap range of two OFDM symbols. At a setting of 100 ns, one sample overlaps.</p> <p>Remote-control command: SOUR:BB:WLAN:OFDM:TTIM 0.0005ms</p>

**Configure MAC Header and FCS... - WLAN** Calls the menu for configuration of the MAC Header and FCS.  
Remote-control command: n.a.

## MAC Header and FCS Configuration - WLAN

In the real IEEE 802.11 system, a MAC (medium access control) header is transmitted in the PSDU prior to the actual data section. This header comprises control information of the MAC layer. It is also possible to protect the PSDU by a frame checksum. These two functions can be controlled in the menu.

Protocol Version	Type	Subtype	To DS	From DS	More Frag	Retry	Pwr Mgt	More Data	WEP	Order
00	00	0000	0	0	0	0	0	0	0	0
2 bit (LSBits)	2 bit	4 bit	1 bit	1 bit	1 bit	1 bit	1 bit	1 bit	1 bit	1 bit (MSBit)

**FCS (checksum) - WLAN** Activates/deactivates the calculation of the FCS (frame check sequence). The standard defines a 32-bit (4-byte) check sum to protect the MAC header and the user data (frame body).

Remote-control command:  
SOUR:BB:WLAN:PSDU:MAC:FCS:STAT ON

**MAC Header - WLAN** Activates/deactivates the generation of the MAC Header for the PSDU. If the MAC header is activated, all MAC header fields are enabled for operation.

The individual fields of the MAC header are described in the following.

All values of the MAC fields (except addresses) are entered in hexadecimal form with LSB in right notation. In the data stream, the values are output standard-conformal with the LSB coming first.

Remote-control command:  
SOUR:BB:WLAN:PSDU:MAC:STAT ON



**Frame Control - WLAN**

Enters the value of the frame control field.

The Frame control field has a length of 2 bytes (16 bits) and is used to define the protocol version, the frame type, sub type and its function, etc.. As an alternative, the individual bits can be set in the lower part of the graph.

Remote-control command:

```
SOUR:BB:WLAN:PSDU:MAC:FCON #H100A,16
SOUR:BB:WLAN:PSDU:MAC:FCON:PVER #H8,2
SOUR:BB:WLAN:PSDU:MAC:FCON:TYPE #H8,2
SOUR:BB:WLAN:PSDU:MAC:FCON:SUBType #H5,4
SOUR:BB:WLAN:PSDU:MAC:FCON:TDS #H8,1
SOUR:BB:WLAN:PSDU:MAC:FCON:FDS #H0,1
SOUR:BB:WLAN:PSDU:MAC:FCON:MFRagments #H8,1
SOUR:BB:WLAN:PSDU:MAC:FCON:RETR #H0,1
SOUR:BB:WLAN:PSDU:MAC:FCON:PMAN #H0,1
SOUR:BB:WLAN:PSDU:MAC:FCON:MDAT #H8,1
SOUR:BB:WLAN:PSDU:MAC:FCON:WEP #H0,1
SOUR:BB:WLAN:PSDU:MAC:FCON:ORD #H8,1
```

802.11 MAC Frame Control Field										
Protocol Version	Type	Subtype	To DS	From DS	More Frag	Retry	Pwr Mgt	More Data	WEP	Order
00	00	0000	0	0	0	0	0	0	0	0
2 bit (LSBits)	2 bit	4 bit	1 bit	1 bit	1 bit	1 bit	1 bit	1 bit	1 bit	1 bit (MSBit)

**Duration Id - WLAN**

Enters the value of the duration Id field.

Depending on the frame type, the 2-byte field Duration/ID is used to transmit the association identity of the station transmitting the frame or it indicates the duration assigned to the frame type.

Remote-control command:

```
SOUR:BB:WLAN:PSDU:MAC:DID #HA5A5,16
```

**MAC Address - WLAN**

Enters the value of the address fields 1 ... 4.

The MAC header may contain up to four address fields, but not all of them must be available. Each of the 4 address fields can be activated or deactivated. The fields are used for transmitting the basic service set identifier, the destination address, the source address, the receiver address and the transmitter address. Each address is 6 bytes (48 bit) long. The addresses can be entered in hexadecimal form in the entry field of each address field. The least significant byte (LSB) is in left notation.

Remote-control command:

```
SOUR:BB:WLAN:PSDU:MAC:ADDR2:STAT ON
SOUR:BB:WLAN:PSDU:MAC:ADDR2 #H124836C7EA54,48
```

**Sequence Control - WLAN** Activates/deactivates the sequence control field.

The sequence control field has a length of 2 bytes and is divided in two parts, the fragment number (4 bits) and the sequence number (12 bits) field. A long user data stream to be transmitted is first split up into MSDUs (MAC service data units) which can either be transmitted as PSDU frames or further divided into fragments. The sequence number and the fragment number are then used to number the individual subpackets of the user data stream to be transmitted. Thus, all PSDUs are assigned a consecutive number. This allows the receiver to arrange the data packets in the correct order, to determine whether an incorrectly transmitted packet was retransmitted and to find out whether packets are missing.

If the receiver can detect a packet without an error and does not request a retransmission, the sequence number is incremented by 1 for each packet (the field is reset to 0 at the latest after a count of 4095). The fragment number field is incremented by 1 when another fragment of the current MPDU is transmitted. The start count for the transmission (normally 0) and the number of packets required to increment the corresponding counter can be defined for both numbers. This is done with the parameters **Start Number** and **Incremented every ... packet(s)** (see below).

**Example:**

An error-free transmission of 50 packets (no packet retransmission) is to be simulated. The sequence number should be incremented by 1 for each packet. Since no packet is fragmented, the fragment counter can always remain at 0. In this case the following values have to be set:

Address 2 (hex)	Address 3 (hex)	Sequence Control		Address 4 (hex)	Frame Body	FCS
Enable <input type="checkbox"/>	Enable <input checked="" type="checkbox"/>	Enable <input checked="" type="checkbox"/>	Enable <input checked="" type="checkbox"/>	Enable <input checked="" type="checkbox"/>		
00000000	000AC776ED2	Frag	Sequ	00023ED34290	0 - 4095	
6 bytes	6 bytes	4 bit	12 bit	6 bytes	bytes	4 byte
Start Number (hex) 0		Start Number (hex) 000		Incremented Every 1 packet(s)		
Incremented Every 4096 packet(s)						

If it is to be simulated that some packets are received incorrectly or if the response of the receiver should be tested when the same packet arrives several times, the number of packets required to increment the sequence number can be set to 2, for example. Each packet will then automatically be sent twice (with identical data).

**Remote-control command:**

```
SOUR:BB:WLAN:PSDU:MAC:SCON:STAT ON
SOUR:BB:WLAN:PSDU:MAC:SCON:FRAG:STAR #H0,4
SOUR:BB:WLAN:PSDU:MAC:SCON:SEQ:STAR #H0,4
SOUR:BB:WLAN:PSDU:MAC:SCON:FRAG:INCR 2
SOUR:BB:WLAN:PSDU:MAC:SCON:SEQ:INCR 4
```

**Start Number - WLAN** Sets the start number of the fragment bits or the sequence bits of the sequence control (see example above).

Remote-control command:

```
SOUR:BB:WLAN:PSDU:MAC:SCON:FRAG:STAR #H0,4
SOUR:BB:WLAN:PSDU:MAC:SCON:SEQ:STAR #H0,4
```

**Increment Every - WLAN** Defines the number of packets required to increment the counter of the fragment bits or the sequence bits of the sequence control (see example above).

Remote-control command:

```
SOUR:BB:WLAN:PSDU:MAC:SCON:FRAG:INCR 2
SOUR:BB:WLAN:PSDU:MAC:SCON:SEQ:INCR 4
```

**Frame Body - WLAN** Indicates the length of the user data (frame body).

Remote-control command: n.a.

**FCS - WLAN** Indicates the length of the check sum.

Remote-control command: n.a.

## PPDU Graph - WLAN

The frame graph in the lower part of the menu indicates the configuration of the PPDU.

The frame structure for the different physical layer modes is described in section "[Physical Layer CCK-PBCC](#)", on page 4.616.

### Physical layer Mode OFDM

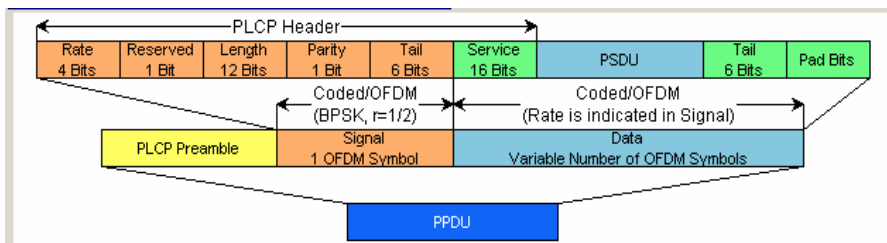

### Physical layer Mode CCK, Long PLCP

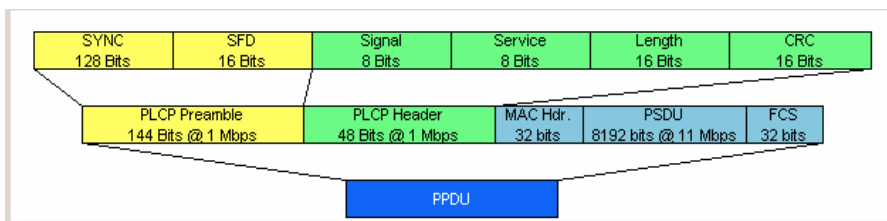

## Filter, Clipping - WLAN

The **Filter, Clipping...** menu is reached via the WLAN main menu.

The filter type and parameters, the chip rate variation (**Filter** section) and clipping (**Clipping** section) are defined in this menu.

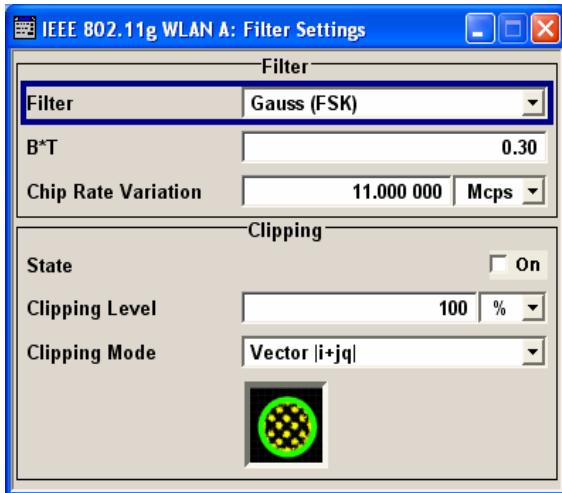

In the **Filter** section, the settings are made for the baseband filter.

### Filter - WLAN

Selects baseband filter.

This opens a selection window containing all the filters available to the instrument.

In 802.11a/g OFDM mode, a cosine filter with roll-off factor 0.1 is used by default to achieve the spectrum masks requirement.

In 802.11b/g CCK/PBCC mode, a gauss (FSK) filter with B\*T 0.5 is used by default to achieve the spectrum masks requirement.

The filter types are described in Section "[Baseband Filter - Custom Digital Mod](#)".

Remote-control command:

```
SOUR:BB:WLAN:FILT:TYPE RCOS
```

### Roll Off Factor or BxT - WLAN

Enters the filter parameters.

The filter parameter offered (Roll Off factor or B\*T) depends on the currently selected filter type. This parameter is always set to the default for each of the predefined filters.

Remote-control commands:

```
SOUR:BB:WLAN:FILT:PAR:APCO25 0.2
SOUR:BB:WLAN:FILT:PAR:COS 0.35
SOUR:BB:WLAN:FILT:PAR:GAUS 0.5
SOUR:BB:WLAN:FILT:PAR:PGA 0.5
SOUR:BB:WLAN:FILT:PAR:RCOS 0.35
SOUR:BB:WLAN:FILT:PAR:SPH 2
```

**Chip Rate Variation - WLAN** Enters the chip rate. For each physical layer mode an own parameter is defined. Which parameter is affected depends on the currently selected mode.

The chip rate entry changes the output clock and the modulation bandwidth, as well as the synchronization signals that are output. It does not affect the calculated chip sequence.

Remote-control command:

```
SOUR:BB:WLAN:CRAT:VAR 11MCPS
```

The settings for clipping are collected in the **Clipping** section.

**Clipping State - WLAN** Switches baseband clipping on and off.

Baseband clipping is a very simple and effective way of reducing the crest factor of the WLAN signal.

WLAN signals may have high crest factors particularly in the 802.11a/g OFDM mode. High crest factors entail two basic problems:

- The nonlinearity of the power amplifier (compression) causes intermodulation which expands the spectrum (spectral regrowth).
- Since the level in the D/A converter is relative to the maximum value, the average value is converted with a relatively low resolution. This results in a high quantization noise.

Both effects increase the adjacent-channel power.

With baseband clipping, all the levels are limited to a settable value (**Clipping Level**). This level is specified as a percentage of the highest peak value. Since clipping is done prior to filtering, the procedure does not influence the spectrum. The EVM however increases. Since clipping the signal not only changes the peak value but also the average value, the effect on the crest factor is unpredictable.

Remote-control command:

```
SOUR:BB:WLAN:CLIP:STAT ON
```

**Clipping Level- WLAN** Sets the limit for clipping.

This value indicates at what point the signal is clipped. It is specified as a percentage, relative to the highest level. 100% indicates that clipping does not take place.

Remote-control command:

```
SOUR:BB:WLAN:CLIP:LEV 50
```

**Clipping Mode - WLAN**

Selects the clipping method. A graphic illustration of the way in which these two methods work is given in the menu.

**Vector  $|i + jq|$**

The limit is related to the amplitude  $|i + jq|$ . The I and Q components are mapped together, the angle is retained.

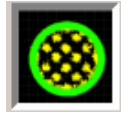

Remote-control command:  
 SOUR:BB:WLAN:CLIP:MODE VECT

**Scalar  $|i| + |q|$**

The limit is related to the absolute maximum of all the  $|i|$  and  $|q|$  values. The I and Q components are mapped separately, the angle changes.

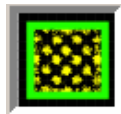

Remote-control command:  
 SOUR:BB:WLAN:CLIP:MODE SCAL

## Trigger/Marker/Clock - WLAN

The **Trigger/Marker/Clock** menu can be reached via the IEEE 802.11a-g WLAN main menu.

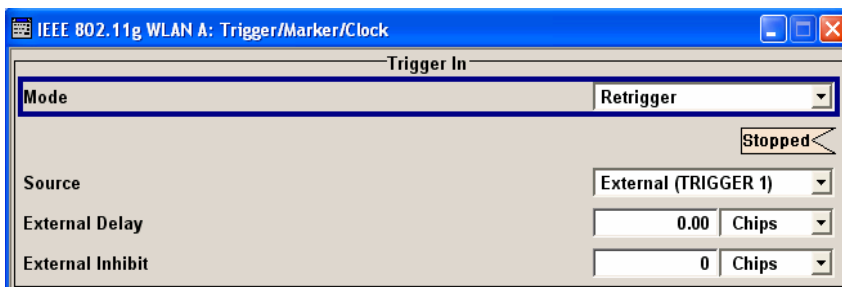

The **Trigger In** section is where the trigger for the IEEE 802.11a-g WLAN signal is set. Various parameters will be provided for the settings, depending on which trigger source - internal or external - is selected. The current status of signal generation (**Running** or **Stopped**) is indicated for all trigger modes.

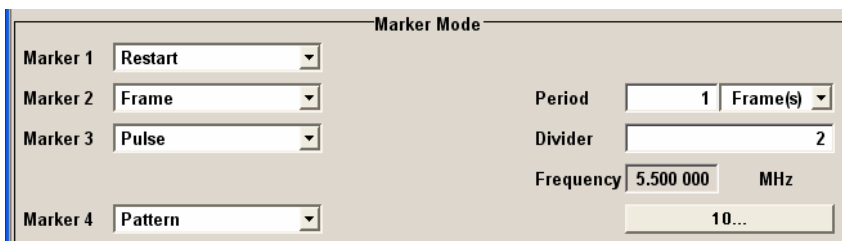

The **Marker Mode** section is where the marker signals at the MARKER output connectors are configured.

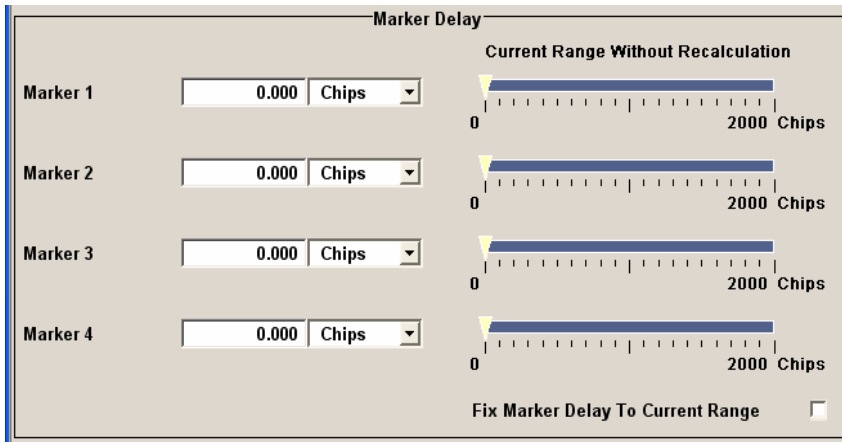

The **Marker Delay** section is where a marker signal delay can be defined, either without restriction or restricted to the dynamic section, i.e., the section in which it is possible to make settings without restarting signal and marker generation.

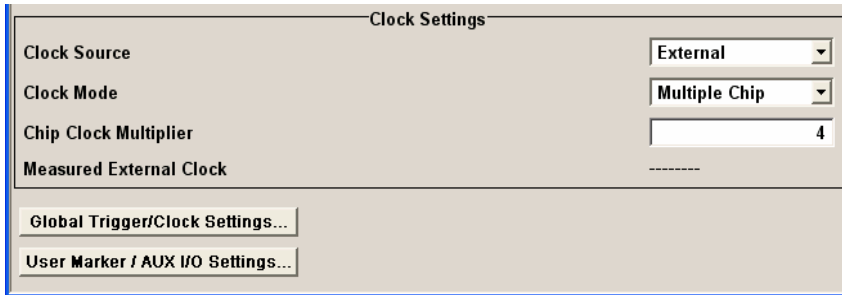

The **Clock Settings** section is where the clock source is selected and - in the case of an external source - the clock type.

The **Global Trigger/Clock Settings** button leads to a submenu for general trigger and clock settings.

The **User marker / AUX I/O Settings** button leads to a submenu for mapping the AUX I/O connector on the rear of the instrument

The **Trigger In** section is where the trigger for the IEEE 802.11a-g WLAN signal is set. The current status of the signal generation is displayed for all trigger modes.

**Trigger Mode - WLAN**

Selects trigger mode.

The trigger mode determines the effect of a trigger on the signal generation.

**Auto**

The IEEE 802.11a-g WLAN signal is generated continuously.

Remote-control command:

```
SOUR:BB:WLAN:SEQ AUTO
```

**Retrigger**

The IEEE 802.11a-g WLAN signal is generated continuously. A trigger event (internal or external) causes a restart.

Remote-control command:

```
SOUR:BB:WLAN:SEQ RETR
```

<b>Armed_Auto</b>	<p>The IEEE 802.11a-g WLAN-Signal signal is generated only when a trigger event occurs. Then the signal is generated continuously.</p> <p>Button <b>Arm</b> stops signal generation. A subsequent trigger event (internal with <b>Execute Trigger</b> or external) causes a restart.</p> <p>Remote-control command: SOUR:BB:WLAN:SEQ AAUT</p>
<b>Armed_Retrigge</b>	<p>The IEEE 802.11a-g WLAN-Signal signal is generated only when a trigger event occurs. Then the signal is generated continuously. Every subsequent trigger event causes a restart.</p> <p>Button <b>Arm</b> stops signal generation. A subsequent trigger event (internal with <b>Execute Trigger</b> or external) causes a restart.</p> <p>Remote-control command: SOUR:BB:WLAN:SEQ ARET</p>
<b>Single</b>	<p>The IEEE 802.11a-g WLAN signal is generated only when a trigger event occurs. Then the signal is generated once to the length specified at <b>Sequence Length</b>. Every subsequent trigger event (internal with <b>Execute Trigger</b> or external) causes a restart.</p> <p>Remote-control command: SOUR:BB:WLAN:SEQ SING</p>
<b>Signal Duration - WLAN</b>	<p>Defines the length of the signal sequence to be output in the <b>Single</b> trigger mode. The input is to be expressed in chips. It is then possible to output deliberately just part of the signal, an exact sequence of the signal, or a defined number of repetitions of the signal.</p> <p>Remote-control commands: SOUR:BB:WLAN:TRIG:SLEN 2000</p>
<b>Signal Duration Unit - WLAN</b>	<p>Defines the unit for the entry of the length of the signal sequence to be output in the <b>Single</b> trigger mode. Available units are frame, chip or sequence length (SL).</p> <p>Remote-control commands: SOUR:BB:WLAN:TRIG:SLUN FRAM</p>



**Running - Stopped - WLAN** Displays the status of signal generation for all trigger modes. This display appears only when IEEE 802.11a-g WLAN is enabled (**State On**).

Remote-control command:  
 SOUR:BB:WLAN:TRIG:RMOD?  
 Response: RUN or STOP

**Running** The IEEE 802.11a-g WLAN modulation signal is generated; a trigger was (internally or externally) initiated in triggered mode.

If **Armed\_Auto** and **Armed\_Retrigger** have been selected, generation of signals can be stopped with the **Arm** button. A new trigger (internally with **Execute Trigger** or externally) causes a restart.

**Stopped** The signal is not generated, and the instrument waits for a trigger event (internal or external).

**Arm - WLAN** Stops signal generation. This button appears only with **Running** signal generation in the **Armed\_Auto** and **Armed\_Retrigger** trigger modes.

Signal generation can be restarted by a new trigger (internally with **Execute Trigger** or externally).

Remote-control command:  
 SOUR:BB:WLAN:TRIG:ARM:EXEC

**Execute Trigger - WLAN** (**Trigger Source Internal only**)

Executes trigger manually. A manual trigger can be executed only when an internal trigger source and a trigger mode other than **Auto** have been selected.

Remote-control commands:  
 SOUR:BB:WLAN:TRIG:SOUR INT  
 SOUR:BB:WLAN:SEQ RETR  
 SOUR:BB:WLAN:TRIG:EXEC

**Trigger Source - WLAN** Selects trigger source. This setting is effective only when a trigger mode other than **Auto** has been selected.

**Internal** The trigger event is executed by **Execute Trigger**.

Remote-control command: :  
 SOUR:BB:W3GP:TRIG:SOUR INT

**Internal (Baseband A/B)** The trigger event is executed by the trigger signal from the second path (two-path instruments only).

Remote-control command:  
 SOUR:BB:W3GP:TRIG:SOUR OBAS

**External  
(TRIGGER 1 / 2)**

The trigger event is executed with the aid of the active edge of an external trigger signal. The trigger signal is supplied via the TRIGGER 1 or TRIGGER 2 connector.

The polarity, the trigger threshold and the input impedance of the TRIGGER input can be set in the **Global Trigger/Clock Settings** menu.

Remote-control command:

```
SOUR:BB:W3GP:TRIG:SOUR EXT | BEXT
```

**Trigger Delay - WLAN**

Sets trigger signal delay in chips on external triggering or on internal triggering via the second path.

This enables the R&S Vector Signal Generator to be synchronized with the device under test or other external devices.

---

**Note:**

*The delay can be set separately for each of the two paths.*

---

Remote-control command: :

```
SOUR:BB:WLAN:TRIG:EXT:DEL 3
```

```
SOUR:BB:WLAN:TRIG:OBAS:DEL 3
```

**Trigger Inhibit - WLAN**

(External) (only Trigger Source External / Internal Other baseband.

Sets the duration for inhibiting a new trigger event subsequent to triggering. The input is to be expressed in chips.

In the **Retrigger** mode every trigger signal causes signal generation to restart. This restart is inhibited for the specified number of chips.

This parameter is only available on external triggering or on internal triggering via the second path.

---

**Note:**

*The trigger inhibit can be set separately for each of the two paths.*

---

Remote-control command :

```
SOUR:BB:WLAN:TRIG:EXT:INH 1000
```

```
SOUR:BB:WLAN:TRIG:OBAS:INH 1000
```

The marker output signal for synchronizing external instruments is configured in the **Marker Settings** section **Marker Mode**.

**Marker x Mode - WLAN**

Selects a marker signal for the associated MARKER output.

**Restart**

A marker signal is generated at the start of each signal sequence (period = selected number of frames).

Remote-control command:

```
SOUR:BB:WLAN:TRIG:OUTP1:MODE REST
```

**Frame Start**

A marker signal is generated at the start of each frame (period = PPDU + idle time).

Remote-control command:

```
SOUR:BB:WLAN:TRIG:OUTP1:MODE FRAM
```

**Frame Active**

A marker signal is generated at the start of every active part of the frame.

The active data transfer part (PPDU) of a frame period is marked with high, the inactive part (idle time) with low. This marker can be used to decrease the carrier leakage during inactive signal parts by feeding it into the pulse modulator.

Remote-control command:

```
SOUR:BB:WLAN:TRIG:OUTP1:MODE FACT
```

**Pulse**

A regular marker signal is generated. The clock frequency is defined by entering a divider. The frequency is derived by dividing the chip rate by the divider. The input box for the divider opens when **Pulse** is selected, and the resulting pulse frequency is displayed below it.

Remote-control commands:

```
SOUR:BB:WLAN:TRIG:OUTP1:MODE PULS
SOUR:BB:WLAN:TRIG:OUTP1:PULS:DIV 4
SOUR:BB:WLAN:TRIG:OUTP1:PULS:FREQ?
```

**Pattern**

A marker signal that is defined by a bit pattern is generated. The pattern has a maximum length of 32 bits and is defined in an input field which opens when **pattern** is selected.

Remote-control commands:

```
SOUR:BB:WLAN:TRIG:OUTP1:MODE PATT
SOUR:BB:WLAN:TRIG:OUTP1:PATT #B1111,4
```

**ON/OFF ratio**

A regular marker signal that is defined by an ON/OFF ratio is generated. A period lasts one ON and OFF cycle.

Start of signal

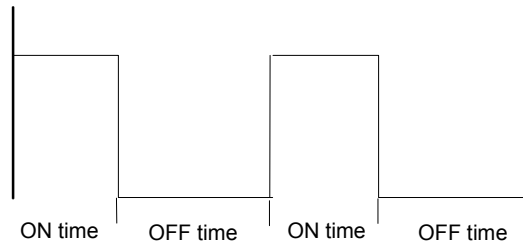

The ON time and OFF time are each expressed as a number of symbols and are set in an input field which opens when **ON/OFF ratio** is selected.

On Time	2	Sym
Off Time	3	Sym

Remote-control commands:

```
SOUR:BB:WLAN:TRIG:OUTP1:MODE RAT
SOUR:BB:WLAN:TRIG:OUTP1:OFFT 20
SOUR:BB:WLAN:TRIG:OUTP1:ONT 20
```

The **Marker Delay** section can be used to set a delay for the markers.

**Marker x Delay - WLAN**

Enters the delay between the marker signal at the marker outputs and the start of the signal.

The input is expressed as a number of chips.

If the setting "**Fix marker delay to dynamic range**" is enabled, the setting range is restricted to the dynamic range. In this range the delay of the marker signals can be set without restarting the marker and signal.

The allocation of marker signals to the outputs is described in the section "[Marker Output Signals](#)".

Remote-control command: :

```
SOUR:BB:WLAN:TRIG:OUTP2:DEL 20
```

**Current Range without Calculation - WLAN**

Displays the dynamic range within which the delay of the marker signals can be set without restarting the marker and signal.

The delay can be defined by moving the setting mark.

Remote-control command:

```
SOUR:BB:WLAN:TRIG:OUTP2:DEL:MAX?
SOUR:BB:WLAN:TRIG:OUTP2:DEL:MIN?
```

**Fix marker delay to current range - WLAN** Restricts the marker delay setting range to the dynamic range. In this range the delay can be set without restarting the marker and signal.

Remote-control command:

SOUR:BB:WLAN:TRIG:OUTP:DEL:FIX ON

The clock source is selected in the **Clock Settings** section.

**Clock Source - WLAN** Selects the clock source (also see section "[Clock Signals](#)").

**Internal** The internal clock reference is used to generate the chip clock.

Remote-control command:

SOUR:BB:WLAN:CLOC:SOUR INT

**External** The external clock reference is fed in as the chip clock or multiple thereof via the CLOCK connector.

The chip rate must be correctly set to an accuracy of  $\pm 2\%$  (see data sheet).

The polarity of the clock input can be changed with the aid of **Global Trigger/Clock Settings**.

In the case of two-path instruments this selection applies to path A.

Remote-control command:

SOUR:BB:WLAN:CLOC:SOUR EXT

**Clock Mode - WLAN** (for external clock source only) Enters the type of externally supplied clock.

**Chip** A chip clock is supplied via the CLOCK connector.

Remote-control command: :

SOUR:BB:WLAN:CLOC:MODE CHIP

**Multiple** A multiple of the chip clock is supplied via the CLOCK connector; the chip clock is derived internally from this.

The **Multiplier** window provided allows the multiplication factor to be entered.

Remote-control command:

SOUR:WIM:CLOC:MODE MCH

**Chip Clock Multiplier - WLAN**

Enters the multiplication factor for clock type **Multiple**.

Remote-control command:

SOUR:BB:WLAN:CLOC:MULT 4

**Measured External Clock - WLAN**

(Clock Source External only) Displays the measured frequency of the external clock signal. This enables the user to permanently monitor the frequency of the externally introduced clock.

This information is displayed only if the external clock source has been selected.

Remote-control command:

:CLOC:INP:FREQ?

**Global Trigger/Clock Settings - WLAN**

Calls the **Global Trigger/Clock/Input Settings** menu. This menu is used among other things for setting the trigger threshold, the input impedance and the polarity of the clock and trigger inputs

In the case of two-path instruments these settings are valid for both paths.

The parameters in this menu affect all digital modulations and standards, and are described in the section "[Global Trigger/Clock/Input Settings – Setup -Environment](#)".

**User Marker / AUX I/O Settings - WLAN**

Calls the **User Marker AUX I/O Settings** menu. This menu is used to map the connector on the rear of the instruments, see section "[User Marker - AUX IO - Setup-Environment-Global...Settings](#)".

# Digital Standard IEEE 802.16 WiMAX

## Introduction - Digital Standard WiMAX

The R&S Vector Signal Generator provides you with the ability to generate signals in accordance with the Institute of Electrical and Electronics Engineers (IEEE 802.16-2004) standard.

WiMAX is a wireless metropolitan-area network technology that provides interoperable broadband wireless connectivity to fixed and portable users. It provides up to 50 kilometers of service area, allows users to get broadband connectivity without the need of direct line-of-sight to the base station, and provides total data rates up to 75 Mbps - enough bandwidth to simultaneously support hundreds of businesses and homes with a single base station.

The equipment layout for IEEE 802.16 WiMAX signal generation includes the options Baseband Main Module (B13), Baseband Generator (B10/B11) and Digital Standard IEEE 802.16 WiMAX (K49). B10 features a much larger ARB memory size than B11 (see data sheet). But apart from the memory size, both options have the same functionality and are installed alternatively.

In the case of two-path instruments, at least one more option, the Baseband Generator (B10/B11) is required to generate an IEEE 802.16 WiMAX signal in the second path. With this option, an IEEE 802.16 WiMAX signal can be defined on path B and then either be routed to path A or added to the path A signal with a settable frequency offset. Generating the IEEE 802.16 WiMAX signal simultaneously on paths A and B requires an additional, second option, the (Digital Standard IEEE 802.16 WiMAX (K49). With a full path B configuration with a second option (Baseband Main Module (B13) and an RF section (frequency option B20x), the IEEE 802.16 WiMAX signal can be output at RF output B.

The R&S Vector Signal Generator generates the IEEE 802.16 WiMAX signals in the arbitrary waveform mode, the signal is first calculated and then output.

The R&S Vector Signal Generator simulates IEEE 802.16 WiMAX at the physical level. Supported features include:

- Configuration of OFDM (orthogonal frequency division multiplexing) and OFDMA (orthogonal frequency division multiple access) physical layer mode.
- Downlink and Uplink mode.
- Pre-defined settings for receiver tests.
- All frame duration settings defined by the standard, including a “user” mode with freely configurable Frame Duration, and a “continuous” mode. In “continuous” mode, gaps between bursts/subframes are eliminated.
- Sequence length of up to 511 frames.
- Up to 64 bursts per frame/zone with independent power setting.
- Channel bandwidth and sampling rate settings according to the ETSI, MMDS, WCS, U-NII or WiBro bands, or alternatively arbitrary settings in “User” mode.
- Full RS/CC, CC and CTC channel coding.
- BPSK, QPSK, 16-QAM or 64-QAM modulation, independently configurable for any of the 64 bursts.
- FCH, DL-MAP and UL-MAP burst generation in “automatic” mode (using signal configuration parameters set by the user) or in “user” mode, with arbitrary data.
- Ranging Bursts in uplink

- Up to 8 Zones per frame in OFDMA mode
- Predefined data sources such as PN9, PN11 and others, or arbitrary user data.
- Optional generic MAC headers and CRC for each burst.
- Subchannelization modes.
- Clipping for reducing the crest factor.

Table 4-29 Parameters of the modulation system IEEE 802.16 WiMAX

Digital standard 802.16-2004	meets IEEE Std 802.16™-2004/Cor1-2005 and 802.16e-2005
Physical layer modes	OFDM, OFDMA, OFDMA – WiBro
Link direction	forward link and reverse link
Frame durations	2, 2.5, 4, 5, 8, 10, 12.5, 20 ms, continuous, user definable
Sequence length	1 – 511 frames (depending on frame duration)
Clipping	Vector or scalar clipping, applied before filtering
Marker modes	Restart, frame start, frame active part, pulse, pattern, on/off ratio
Parameters in OFDM Mode	
Duplexing	TDD, FDD
Predefined frames	Short, mid and long length test messages for testing receivers with all modulation types and RS-CC rates
Level reference	FCH/Burst or preamble level
Frequency bands	ETSI, MMDS, WCS, U-NII, User
Channel bandwidth	1.25 – 30 MHz, depending on selected frequency band
Sampling rate	1.5 – 32 MHz, depending on channel bandwidth
Tg / Tb settings	1/4, 1/8, 1/16, 1/32
FFT size	256 (fixed)
Nr. Of possible subchannels in subchannelization mode	1, 2, 4, 8, 16 (all)
Nr. Of bursts per frame	0 – 64
Preamble / midamble modes	Burst preamble / midambles off, burst preamble in downlink, midamble repetition 5, 9 or 17 in uplink
Modulation & RS-CC rates	BPSK 1/2, QPSK 1/2, QPSK 3/4, 16-QAM 1/2, 16-QAM 3/4, 64-QAM 2/3, 64-QAM 3/4
Data	all 0 , all 1, pattern (up to 64 bit), PN 9 to PN 23, data lists
Burst power range	-80 dB - +10 dB
MAC functions	One generic MAC header + CRC available per burst
Parameters in OFDMA Mode	
Duplexing	TDD
Level reference	Subframe RMS Power or preamble level (downlink only)
Frequency bands	ETSI, MMDS, WCS, U-NII, WiBro, User
Channel bandwidth	1.25 – 30 MHz, depending on selected frequency band
Sampling rate	1.5 – 32 MHz, depending on channel bandwidth
Tg / Tb settings	1/4, 1/8, 1/16, 1/32
FFT size	128, 512, 1024 or 2048
Subcarrier Permutation	PUSC, FUSC (downlink only)
Nr. Of bursts per frame	0 – 64
Modulation & CC rates	QPSK 1/2, QPSK 3/4, 16-QAM 1/2, 16-QAM 3/4, 64-QAM 1/2, 64-QAM 2/3, 64-QAM 3/4
Data	all 0 , all 1, pattern (up to 64 bit), PN 9 to PN 23, data lists
Burst power range	-80 dB - +10 dB



MAC functions	One generic MAC header + CRC available per burst
Parameters in OFDMA - WiBro Mode (identical to OFDMA)	
Duplexing	TDD
Level reference	Subframe RMS Power or preamble level (downlink only)
Frequency bands	ETSI, MMDS, WCS, U-NII, WiBro, User
Channel bandwidth	1.25 – 30 MHz, depending on selected frequency band
Sampling rate	1.5 – 32 MHz, depending on channel bandwidth
Tg / Tb settings	¼, 1/8, 1/16, 1/32
FFT size	128, 512, 1024 or 2048
Subcarrier Permutation	PUSC, FUSC (downlink only)
Nr. Of bursts per frame	0 – 64
Modulation & CC rates	QPSK ½, QPSK ¾, 16-QAM ½, 16-QAM ¾, 64-QAM ½, 64-QAM 2/3, 64-QAM ¾
Data	all 0 , all 1, pattern (up to 64 bit), PN 9 to PN 23, data lists
Burst power range	-80 dB - +10 dB
MAC functions	One generic MAC header + CRC available per burst

## WiMAX Menu

The menu for setting the IEEE 802.16 WiMAX digital standard is either called from the baseband block or from the menu tree under Baseband.

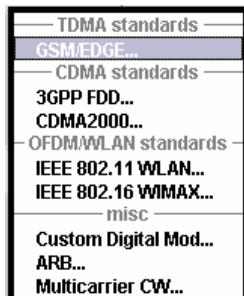

The menu is split into several sections for configuring the standard. The choice of transmission direction determines which displays and parameters are made available in the lower section.

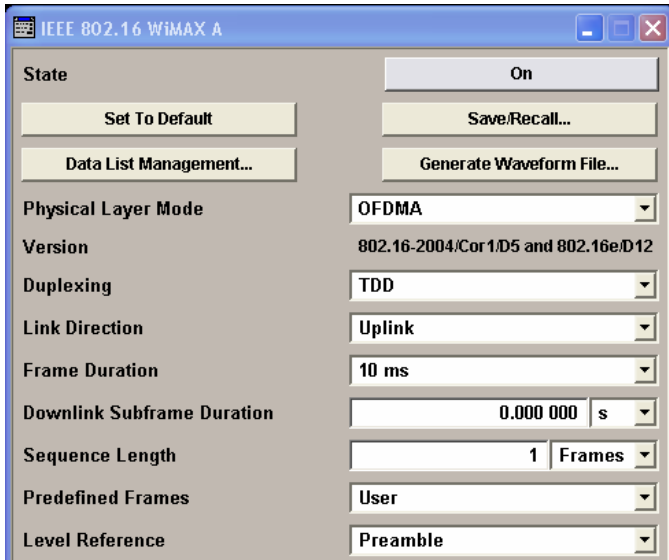

The upper section of the menu is where the IEEE 802.16 WiMAX digital standard is enabled, the default settings are called and the physical layer mode, the duplexing and the transmission direction are selected. Additional parameters include Frame Duration, Sequence Length and a set of Predefined Frames for receiver testing.

A button leads to the submenu for loading and saving the IEEE 802.16 WiMAX configuration.



The buttons of the lower menu section lead to submenus for configuring the frame and for setting the filter, clipping, trigger and clock parameters.

## General Settings for WiMAX Signals

The upper menu section is where the IEEE 802.16 WiMAX digital standard is enabled and reset and where all the settings for the signal in both transmission directions are made.

### State - WiMAX

Enables/disables the IEEE 802.16 WiMAX standard.

Enabling this standard disables all the other digital standards and digital modulation modes on the same path.

The IEEE 802.16 WiMAX signal is generated in arbitrary waveform mode.

Remote-control command:  
`SOUR:BB:WIM:STAT ON`

**Set to Default - WiMAX**

Calls the default settings. The following table gives an overview of the settings. The preset value for each parameter is specified in the description of the remote-control commands.

Remote-control command:

SOUR:BB:WIM:PRES

Parameter	Value
<b>General Settings</b>	
State	Not affected by Set to default
Physical Layer Mode	OFDM
Duplexing	TDD
Link Direction	Downlink
Frame Duration	10 ms
Sequence Length	1 frame
Predefined Frames	User
Level Reference	FCH/Burst
Clipping	Off
<b>OFDM mode</b>	
Frequency Band	ETSI
Channel Bandwidth	1.75 MHz
Sampling Rate	2.000 MHz
BSID (4 LSBs)	0
Tg/Tb	1/4
Nr. of used Subchannels	16 (all)
Frame Preamble	Long
FCH Configuration	On, Auto mode, Frame Number Offset = 0 and Configuration Change Count = 0
Nr. of Bursts	1
<b>OFDMA mode</b>	
Frequency Band	ETSI
Channel Bandwidth	1.75 MHz
Sampling Rate	2.000 MHz
n =	8/7
Tg/Tb	1/4
FFT Size	2048
Subcarrier Permutation	PUSC
Subchannel 0 ... 59 State	ON
<b>OFDMA - WiBro mode</b>	
Frequency Band	WiBro
Channel Bandwidth	8.75 MHz
Sampling Rate	
n =	
Tg/Tb	1/8
FFT Size	1024
Subcarrier Permutation	
Subchannel 0 ... 59 State	
Frame Duration	5 ms

**Save/Recall - WiMAX**

Calls the **Save/Recall** menu.

From the **Save/Recall** menu, the **File Select** windows for saving and recalling IEEE 802.16 WiMAX configurations and the **File Manager** can be called.



IEEE 802.16 WiMAX configurations are stored as files with the predefined file extension **\*.wimax**. The file name and the directory they are stored in are user-definable.

The complete settings in the **IEEE 802.16 WiMAX** menu are saved and recalled.

**Recall WiMAX Setting** Opens the **File Select** window for loading a saved IEEE 802.16 WiMAX configuration.

The configuration of the selected (highlighted) file is loaded by pressing the **Select** button.

Remote-control command:

```
MMEM:CDIR 'F:\gen_lists\wimax'
```

```
SOUR:BB:WIM:SETT:CAT?
```

Response:

```
'wimax_1',wimax_2'
```

```
SOUR:BB:WIM:SETT:LOAD "wimax_1"
```

**Save WiMAX Setting** Opens the **File Select** window for saving the current IEEE 802.16 WiMAX signal configuration.

The name of the file is specified in the **File name** entry field, the directory selected in the **save into** field. The file is saved by pressing the **Save** button.

Remote-control command:

```
MMEM:CDIR 'F:\gen_lists\wimax'
```

```
SOUR:BB:WIM:SETT:STOR 'wimax_3'
```

**File Manager**

Calls the **File Manager**.

The **File Manager** is used to copy, delete, and rename files and to create new directories.

Remote-control commands::

```
MMEM:CDIR 'F:\gen_lists\wimax'
```

```
SOUR:BB:WIM:SETT:DEL 'wimax_1'
```

**Data List Management... - WiMAX**

Calls the **Data List Management** menu. This menu is used to create and edit a data list.

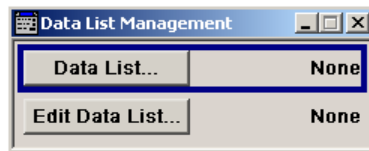

All data lists are stored as files with the predefined file extension **\*.dm\_iqd**. The file name and the directory they are stored in are user-definable.

The data lists must be selected as a data source from the submenus under the individual function, e.g. in the channel table of the cells.

Remote-control commands:

**Note:**

*All data lists are generated and edited by means of the SOURce:BB:DM subsystem commands. Files containing data lists usually end with \*.dm\_iqd. The data lists are selected as a data source for a specific function in the individual subsystems of the digital standard.*

Creating and editing the data list:

```
SOUR:BB:DM:DLIS:SEL "d_list1"
```

```
SOUR:BB:DM:DLIS:DATA #B1111010101000001111....
```

```
SOUR:BB:DM:DLIS:DATA:APP #B1111010101000001111....
```

Selecting the data list:

```
SOUR:BB:WIM:AOFD:ZONE0:BURS1:DATA:DLIS
```

```
SOUR:BB:WIM:AOFD:ZONE0:BURS1:DATA:DSEL "dlist1"
```

```
SOUR:BB:WIM:OFDM:BURS1:DATA:DLIS
```

```
SOUR:BB:WIM:OFDM:BURS1:DATA:DSEL "dlist1"
```

```
SOUR:BB:WIM:OFDM:FCH:DATA:DLIS
```

```
SOUR:BB:WIM:OFDM:FCH:DATA:DSEL "dlist1"
```

**Generate Waveform File... - WiMAX** - Calls the **Generate Waveform** menu. This menu is used to store the current WiMAX signal as ARB signal in a waveform file.

This file can be loaded in the **ARB** menu and processed as multicarrier or multisegment signal.

The file name is entered in the submenu. The file is stored with the predefined file extension \*.**wv**. The file name and the directory it is stored in are user-definable.

Remote-control commands:

```
SOUR:BB:WIM:WAV:CRE "c:\temp\wimax.wv"
```

**Physical Layer Mode - WiMAX**

Selects the physical layer mode. The settings of the frame are provided in the submenu **Frame Configuration** (see following section) in accordance with the selection.

**OFDM**

The OFDM mode supports signal generation according to IEEE 802.16-2004 section 8.3 with a fixed FFT size of 256.

Remote-control command:

```
SOUR:BB:WIM:MODE OFDM
```

**OFDMA**

Orthogonal Frequency Division Multiple Access (OFDMA) groups multiple subcarriers of the OFDM into sub-channels. A single client or subscriber station might transmit using all of the sub-channels within the carrier space, or multiple clients might transmit with each using a portion of the total number of sub-channels simultaneously. OFDMA thus enables a more flexible use of resources. It can support nomadic and mobile operation.

Remote-control command:

```
SOUR:BB:WIM:MODE AOFD
```

**OFDMA - WiBro** The OFDMA – WiBro (Wireless Broadband) mode groups multiple subcarriers of the OFDM into sub-channels. A single client or subscriber station might transmit using all of the sub-channels within the carrier space, or multiple clients might transmit with each using a portion of the total number of sub-channels simultaneously. OFDMA thus enables a more flexible use of resources. It can support nomadic and mobile operation.

The OFDMA – WiBro mode is identical to the OFDMA mode. When selecting OFDMA – WiBro, these parameters are set to their WiBro defaults (see [Set to Default – WiMAX](#)):

Frame Duration: 5ms

Frequency Band: WiBro

Channel Bandwidth: 8.75 MHz

Sampling Rate: 10 MHz

Tg/Tb: 1/8

FFT Size: 1024

Remote-control command:

SOUR:BB:WIM:MODE WIBR

#### **Version - WiMAX**

Displays the current versions of the WiMAX standard. The display depends on the selected physical layer mode.

Remote-control command:

SOUR:BB:WIM:VERS?

Response: 802.16-2004/Cor1-2005

#### **Duplexing - WiMAX**

Selects the duplexing. The duplexing mode determines how the uplink and downlink signals are separated.

#### **TDD**

In TDD mode, the same frequency is used for both directions of transmission (uplink and downlink). With one baseband, either downlink or uplink frames can be generated.

Remote-control command:

SOUR:BB:WIM:DUPL TDD

**FDD  
(OFDM only)**

In FDD mode, different frequencies are used for downlink and uplink directions. If only one link direction is considered at once, the IEEE 802.16 standard defines no differences between TDD and FDD signals on the physical layer.

The FDD mode has been provided for convenience, it completely fills the defined frame with bursts to simulate a continuous transmission environment. It is recommended to use TDD mode instead if FDD devices are to be tested with frames including transmission gaps.

Remote-control command:  
SOUR:BB:WIM:DUPL FDD

**Link Direction - WiMAX**

Selects the transmission direction.

**Downlink**

The transmission direction selected is base station to subscriber station. The signal corresponds to that of a base station.

Remote-control command:  
SOUR:BB:WIM:LINK DOWN

**Uplink**

The transmission direction selected is subscriber station to base station. The signal corresponds to that of a subscriber station.

Remote-control command:  
SOUR:BB:WIM:LINK UP

**Frame Duration - WiMAX**

Selects the frame duration.

Only distinct values are allowed in the standard. For test reasons, continuous generation or generation for a freely selectable duration (User) are available. In continuous mode, the frame duration equals the sum of the burst durations in OFDM mode or the subframe duration in OFDMA mode.

Remote-control command:  
SOUR:BB:WIM:FRAM:TIME MS4

**User Frame Duration - WiMAX**

Sets the frame duration for selection **User**. The values are freely selectable.

Remote-control command:  
SOUR:BB:WIM:FRAM:TIME:USER 0.0043



**Downlink Subframe  
Duration - WiMAX**

**(This feature is only available for the uplink direction in TDD mode.)**

Delays the first uplink burst by the set time duration.

Remote-control command:

SOUR:BB:WIM:SUBF:TIME 0.1ms

**Initial Delay of Burst 1 -  
WiMAX**

**(This feature is only available for the uplink direction in FDD mode with physical layer mode OFDM.)**

Delays the first uplink burst by the set time duration.

In FDD mode, this parameter is provided for convenience to enable a constant delay of the signal with respect to an internal or external frame trigger.

Remote-control command:

SOUR:BB:WIM:FRAM:BURS:DEL 0.1

**Sequence Length - WiMAX**

Sets the sequence length of the signal in number of frames. The signal is calculated in advance and output in the arbitrary waveform generator. Burst d

Remote-control command:

SOUR:BB:WIM:SLEN 20

**Predefined Frames - WiMAX**

Selects the frame type.

**Test Message BPSK 1/2 Short,** Predefined setups for receiver test messages according to IEEE 802.16-2004 section 8.3.11

**Test Message BPSK 1/2 Mid,** Remote-control command:  
SOUR:BB:WIM:OFDM:FRAM:PRED FBPSK12MID

...  
**(OFDM only)**

**User** The settings for the frame can be defined by the user.

Remote-control command:  
SOUR:BB:WIM:OFDM:FRAM:PRED USER  
SOUR:BB:WIM:AOFD:FRAM:PRED USER

**Level Reference - WiMAX**

Selects the level reference.

**FCH / Burst (OFDM only)** The instrument's level setting refers to the mean power of FCH (Frame Control Header) or bursts with a burst power setting of 0 dB.

To obtain the absolute burst power value, the burst power value has to be added to the level value.

Remote-control command:  
SOUR:BB:WIM:OFDM:POW:REF BURS

**Preamble (OFDM uplink and downlink)** The instrument's level setting refers to the preamble, which is

FCH / Burst power + 3dB in OFDM mode.

Remote-control command:  
SOUR:BB:WIM:OFDM:POW:REF PRE  
SOUR:BB:WIM:AOFD:POW:REF PRE

**OFDMA/OFDMA - WiBro downlink only)**

**Subframe RMS power (OFDMA/OFDMA - WiBro only)** The instrument's level setting refers to the rms power of the subframe. This includes the preamble and all symbols with allocated carriers in downlink or the whole uplink subframe in uplink.

Remote-control command:  
SOUR:BB:WIM:AOFD:POW:REF PRE

**Frame Configuration - WiMAX**

Calls the menu for configuration of the frame.

The menu is described separately for the two physical layer modes in sections "[Frame Configuration OFDM - WiMAX](#)", Page 4.664, and "[Frame Configuration OFDMA - WiMAX](#)", Page 4.681.

Remote-control command: n.a.

- Filter / Clipping - WiMAX** Calls the menu for setting clipping and the sample rate variation of the arbitrary waveform. The current setting is displayed next to the button.  
The menu is described in Section "[Filtering, Clipping, ARB Settings - 3GPP FDD](#)", Page 4.337.  
Remote-control command: n.a.
- Trigger - Marker - WiMAX** Calls the menu for selecting the trigger source, for configuring the marker signals and for setting the time delay of an external trigger signal (see Section "[Trigger/Marker/Clock - 3GPP FDD](#)", Page 4.332).  
The currently selected trigger source is displayed to the right of the button.  
Remote-control command: n.a.
- Execute Trigger - WiMAX** Executes trigger manually.  
A manual trigger can be executed only when an internal trigger source and a trigger mode other than **Auto** have been selected.  
Remote-control commands:  
SOUR:BB:WIM:TRIG:SOUR INT  
SOUR:BB:WIM:SEQ RETR  
SOUR:BB:WIM:TRIG:EXEC
- Clock - WiMAX** Calls the menu for selecting the clock source and for setting a delay (see Section "[Trigger/Marker/Clock - 3GPP FDD](#)", Page 4.332").  
Remote-control command: n.a.

# Frame Configuration OFDM - WiMAX

This menu provides all parameters to configure frames in OFDM mode. The menu differs depending on the selected link direction. The following graph shows the menu for downlink direction.

IEEE 802.16 WiMAX A: Frame Configuration OFDM

Frequency Band: WCS

Channel Bandwidth: 2.50 MHz

Sampling Rate: 2.88 MHz

BSID (4 LSBs): 0

No. Of Bursts: 1

Tg/Tb: 1/4

n = 144/125

No. Of Used Subchannels: 16 (all)

Subchannel Index: 16

Frame Number: 0

Generate UL-MAP...

	Pre- amble	Midam- ble Rep	Modulation & RS-CC Rate	Chan Cod	Data Length	Sym- bols	Data Source	Dlist Pattern	Boost [dB]	Burst Type	More Params	Gap [μs]
0	Off	Off	QPSK 3/4	On	100	3	PN 9		0.00	Data	Config..	1 000
1	Short	Off	QPSK 3/4	On	100	3	PN 9		0.00	Data	Config..	1 000
2	Short	Off	QPSK 3/4	On	100	3	PN 9		0.00	Data	Config..	1 000
3	Short	Off	QPSK 3/4	On	100	3	PN 9		0.00	Data	Config..	1 000
4	Short	Off	QPSK 3/4	On	100	3	PN 9		0.00	Data	Config..	1 000
5	Short	Off	QPSK 3/4	On	100	3	PN 9		0.00	Data	Config..	1 000
6	Short	Off	QPSK 3/4	On	100	3	PN 9		0.00	Data	Config..	1 000
7	Short	Off	QPSK 3/4	On	100	3	PN 9		0.00	Data	Config..	1 000

Show Active Carriers...

**Frequency Band OFDM-WiMAX**

Selects the frequency band for the carrier frequencies. The available ranges for setting the channel bandwidth and the sampling rate depend on the selection here.

**ETSI** The frequency band as defined by the **European Telecommunications Standards Institute** applies.

The range is 1.75 to 28 MHz for the channel bandwidth and 2 to 32 MHz for the sampling rate.

Remote-control command:

SOUR:BB:WIM:OFDM:FBAN ETSI

**MMDS** The frequency band as defined by the **Multichannel Multipoint Distribution Service** applies. The RF frequency range is 2500 to 2686 MHz.

The range is 1.50 to 24 MHz for the channel bandwidth and 1.72 to 27.52 MHz for the sampling rate.

Remote-control command:

SOUR:BB:WIM:OFDM:FBAN MMDS

**WCS** The frequency band as defined by the **Wireless Communication Service** applies. It is in the 2.3 GHz band of the electromagnetic spectrum from 2305 to 2320 MHz and 2345 to 2360 MHz.

The range is 2.5 to 15 MHz for the channel bandwidth and 2.88 to 17.28 MHz for the sampling rate.

Remote-control command:

SOUR:BB:WIM:OFDM:FBAN WCS

**U-NII** The frequency band as defined by the **Unlicensed National Information Infrastructure** applies. It is in the 5 GHz band of the electromagnetic spectrum from 5150 to 5350 GHz and 5750 to 5825 GHz.

The range is 10 to 20 MHz for the channel bandwidth and 11.52 to 23.04 MHz for the sampling rate.

Remote-control command:

SOUR:BB:WIM:OFDM:FBAN UNII

**User** This mode is provided for choosing any other channel bandwidth / sampling rate combination.

The range is 1.25 to 28 MHz for the channel bandwidth and 1.44 to 32 MHz for the sampling rate.

Remote-control command:  
`SOUR:BB:WIM:OFDM:FBAN USER`

**Channel Bandwidth OFDM - WiMAX**

Sets the channel bandwidth. The range is 1.25 to 28 MHz.

The selected channel bandwidth has to be a multiple of 1.25, 1.5, 1.75, 2.0 or 2.75 MHz. The channel bandwidth determines the parameter n (sampling ratio, see below):

For channel bandwidths

- that are a multiple of 1.75 MHz then  $n = 8/7$
- that are a multiple of 1.5 MHz then  $n = 86/75$
- that are a multiple of 1.25 MHz then  $n = 144/125$
- that are a multiple of 2.75 MHz then  $n = 316/275$
- that are a multiple of 2.0 MHz then  $n = 57/50$

else for channel bandwidths not otherwise specified then  $n = 8/7$

The sampling rate is derived from the channel bandwidth as follows:

$$\text{SamplingRate} = \text{floor}(n * \text{ChannelBandwidth} / 8000) * 8000$$

Remote-control command:  
`SOUR:BB:WIM:OFDM:BW 14 MHz`

**Sampling Ratio n OFDM - WiMAX**

Indicates the sampling ratio. The sampling ratio is determined by the channel bandwidth (see above, parameter **Channel Bandwidth**).

Remote-control command:  
`SOUR:BB:WIM:OFDM:N?`

**Sampling Rate OFDM - WiMAX**

Sets the sampling rate. The possible settings depend on the selected frequency band. The full range in **User** mode is 1.44 to 32 MHz.

The sampling rate is related to the channel bandwidth by the parameter n:

$$\text{SamplingRate} = \text{floor}(n * \text{ChannelBandwidth} / 8000) * 8000$$

Remote-control command:  
`SOUR:BB:WIM:OFDM:SRAT 2 MHz`

<b>BSID OFDM - WiMAX</b>	<p>Sets the 4 LSBs of the Base Station ID.</p> <p>The BSID is transmitted in the FCH (when set to <b>Auto</b> mode), and it is used to initialize the randomizer.</p> <p>Remote-control command: SOUR:BB:WIM:OFDM:BSID 4</p>
<b>Number of Bursts OFDM - WiMAX</b>	<p>Sets the number of active bursts in one frame.</p> <p>With number of bursts = 0, a preamble only or a preamble with an FCH burst is generated.</p> <p>Remote-control command: SOUR:BB:WIM:OFDM:BURS:COUN 2</p>
<b>Tg/Tb Ratio OFDM - WiMAX</b>	<p>Selects the ratio of guard period to symbol period.</p> <p>This value sets the length of the cyclic prefix in fractions of the symbol period.</p> <p>Remote-control command: SOUR:BB:WIM:OFDM:TGTB TGTB1D16</p>
<b>Number of used Subchannels OFDM - WiMAX</b>	<p>Selects the number of used subchannels.</p> <p>Selection 16 (all) deactivates subchannelization and activates all possible carriers. The values 1, 2, 4 and 8 activate only a part of the available subcarriers, unused carriers are blanked.</p> <p>Remote-control command: SOUR:BB:WIM:OFDM:SUBC:COUN SC2</p>
<b>Subchannel Index OFDM - WiMAX</b>	<p>Selects the subchannel index in subchannelization mode.</p> <p>The subchannel index determines the set of used subcarriers according to table 213 of IEEE 802.16-2004 standard.</p> <p>Remote-control command: SOUR:BB:WIM:OFDM:SUBC:IND SUBC4</p>
<b>Frame Preamble OFDM - WiMAX</b>	<p>Activates/deactivates the generation of a frame preamble. Either a long preamble or a short preamble can be activated.</p> <p>The 802.16 standard requires a long preamble as frame start.</p> <p>Remote-control command: SOUR:BB:WIM:OFDM:PRE:MODE LONG</p>
<b>Frame Number OFDM - WiMAX</b>	<p>Selects the frame number of the uplink frame in which the UL map that specifies the uplink burst was transmitted.</p> <p>Remote-control command: SOUR:BB:WIM:OFDM:FRAM:NUMB 13</p>

**Configure FCH OFDM - WiMAX**

Calls the menu for configuring FCH mode and parameters (see section "

*FCH Configuration Downlink* OFDM- WiMAX", on page 4.673).

Remote-control command: n.a.

**Generate UL-MAP - WiMAX**

Calls the menu for generating the UL-map.

Remote-control command: n.a.

## Burst Table OFDM- WiMAX

The **burst table** is located in the lower part of the menu. The burst table is where the individual burst parameters are set. A graphic display below the table shows length, position and power of all configured bursts within the frame.

Up to 64 bursts can be configured per frame. Each table row defines the settings of one specific burst, where the first row defines the first burst of the frame and the last row defines the last burst.

For both transmission directions, different modulations and channel coding rates are available for each burst. A generic MAC header with encrypted payload and checksum determination can be activated.

Some setting parameters differ for the two transmission directions. The graph below shows the table in uplink direction.

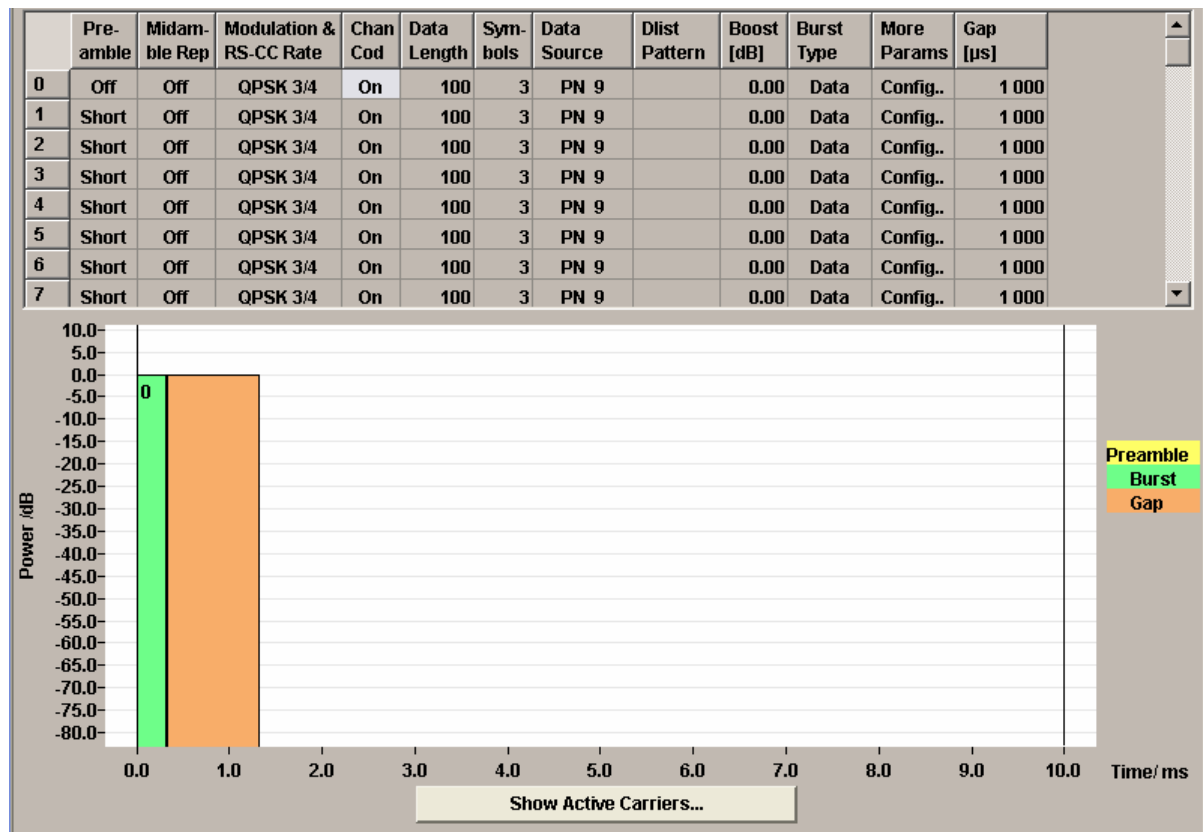



- Burst Index OFDM - WiMAX** Displays the consecutive burst index from 0 to 63.
- All the rows are always displayed, even if the bursts are inactive. They are switched on and off by the selection of **No. of Bursts** above the table. The active bursts are highlighted.
- Remote-control command: n.a.  
(selected via the suffix to the keyword :BURSt<n> )
- Preamble OFDM - WiMAX** Enables generation of the burst preamble.
- If activated, a preamble is placed before the burst. Long or short preambles are available. The preamble has the same power as the burst. If subchannelization is used, a subchannelization preamble is generated accordingly.
- Remote-control command:  
SOUR:BB:WIM:OFDM:BURS2:PRE:MODE OFF
- Midamble Repetition OFDM - WiMAX** Activates/deactivates midamble repetition.
- If midamble repetition is switched on, midambles are placed into the burst with the specified interval, i.e. if 5 is selected, every 5<sup>th</sup> symbol of the burst is a midamble.
- A short preamble is used as midamble when subchannelization is off or a subchannelization preamble is used in subchannelization mode. The power of the midambles
- Remote-control command:  
SOUR:BB:WIM:OFDM:BURS2:MID REP5
- Modulation and RS-CC Rate OFDM - WiMAX** Selects the modulation and channel coding rate. Channel coding includes randomization, reed solomoon coding, convolutional coding and interleaving.
- For a given modulation type and channel coding rate, the data length determines the number of symbols and vice versa.
- Remote-control command:  
SOUR:BB:WIM:OFDM:BURS:FORM QPSK3D4
- Channel Coding OFDM - WiMAX** Switches channel coding on or off.
- If channel coding is switched off, the bits read from the data source are directly modulated onto the carriers. Due to randomization missing, this could result in very high crest factors of the signal.
- Remote-control command:  
SOUR:BB:WIM:OFDM:BURS:CCOD:STAT ON

**Data Length OFDM -  
WiMAX**

Determines the data length in bytes.

The given number of bytes is read from the data source. The total number of data bytes in the burst (before channel coding) is determined as follows:

$$\text{TotalDataBytes} = \text{DataLength} + \text{MACHeaderBytes} + \text{CRCBytes} + \text{TailByte}$$

The tail byte is only added when channel coding is switched on. The same is the case for the MAC header and CRC, they are not added when switched off. Additionally padding with 0xFF bytes is applied at the end of the data sequence to reach an integer number of OFDM symbols.

The data length determines the number of symbols and vice versa. The maximum data length of 10000 bytes defines the maximum number of symbols for a given modulation type and channel coding rate.

Remote-control command:

```
SOUR:BB:WIM:OFDM:BURS:DLEN 1000
```

**Number of Symbols OFDM  
- WiMAX**

Enters the number of symbols for the selected burst. If the number of symbols is changed, the data length is adjusted to fill the specified number of symbols with data so that no padding has to be applied.

The maximum data length of 10 000 bytes defines the maximum number of symbols for a given modulation type and channel coding rate.

Remote-control command:

```
SOUR:BB:WIM:OFDM:BURS:SYMB:COUN 114
```

**Data Source OFDM -  
WiMAX**

Selects data source for the selected bursts.

The data sources **PN9**, **PN11**, **PN15**, **PN16**, **PN20**, **PN21**, **PN23**, **ALL 0**, **ALL1**, **Pattern** and **Data List** are all available to choose from.

**Data lists** can be generated internally in the data editor or externally.

Data lists are selected in the **File Select** window, which is called by means of the **Data List Management** button.

If the **Pattern** data type is used, the bit pattern is defined in the **Pattern** input box. The length is limited to 64 bits.

Remote-control command

```
SOUR:BB:WIM:OFDM:BURS2:DATA PATT
SOUR:BB:WIM:OFDM:BURS2:DATA:PATT #H3F,8
```

```
SOUR:BB:WIM:OFDM:BURS2:DATA DLIS
SOUR:BB:WIM:OFDM:BURS2:DATA:DSEL "BS2_OFDM"
```

<b>DIUC OFDM - WiMAX</b>	<p>Sets the specific interval usage code.</p> <p>The code is used to initialize the randomizer.</p> <p>Remote-control command:  SOUR:BB:WIM:OFDM:BURS2:DIUC 2</p>
<b>Boost OFDM - WiMAX</b>	<p>Sets the burst power in dB.</p> <p>To set the absolute power of a burst correctly, level reference <b>FCH / Burst</b> must be selected. In this mode, the output power of a burst equals Level + BurstPower.</p> <p>Remote-control command:  SOUR:BB:WIM:OFDM:BURS2:POW -20</p>
<b>MAC Header OFDM - WiMAX</b>	<p>Calls the menu for configuring the generic MAC (Media Access Control) header of the selected burst and for activating the checksum determination.</p> <p>Remote-control command: n.a.</p>
<b>Burst Type OFDM - WiMAX</b>	<p>Select the burst type from Data, DL-MAP, UL-MAP or Ranging.</p> <p><b>DATA</b> Remote-control command:  SOUR:BB:WIM:OFDM:BURS2:TYPE DATA</p> <p><b>DL-MAP</b> Remote-control command:  SOUR:BB:WIM:OFDM:BURS2:TYPE DLM</p> <p><b>UL-MAP</b> A UL-MAP is generated using the specified data list, including additional parameters from the “More Params” panel. See “<a href="#">Generate UL-MAP - WiMAX</a>” for more information on how to create UL-MAP bursts.</p> <p>Remote-control command:  SOUR:BB:WIM:OFDM:BURS2:TYPE ULM</p> <p><b>Ranging</b> An uplink ranging burst is composed of a long preamble following two subchannelized preambles using one active subchannel. The subchannel index for the two preambles is read from the configured data source. For each frame 4 bits are read from the data source (called “data”), which define the subchannel index as follows:  Index = data * 2 + 1</p> <p>Remote-control command:  SOUR:BB:WIM:OFDM:BURS2:TYPE RANG</p>

**More Parameter OFDM – WiMAX**

Calls the menu for configuring additional parameters for the bursts.

Remote-control command: n.a.

**Gap OFDM - WiMAX**

Sets the length of the gap between the selected burst and the next burst in  $\mu$ s. The setting is only available for transmission direction uplink.

Remote-control command :

SOUR:BB:WIM:OFDM:BURS2:GAP 0.001

## Frame Graph OFDM - WiMAX

The frame graph indicates the configuration of one frame. The scaling of the X-axis is always adapted to the set frame duration. The preamble length, FCH length and the burst length are drawn to scale. The relative power can be taken from the height of the bar. The power of the preamble is always +3 dB and of the FCH always 0 dB relative to the power of the other bursts.

The shown frame configuration is repeated over the whole sequence length.

In downlink direction the frame preamble is sent at the beginning of the frame.

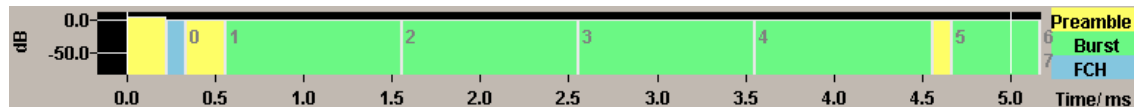

In uplink direction each burst starts with a preamble. The first gap at the beginning of the frame is determined by the Downlink Subframe Duration (specified in the main menu), the following gaps are defined by the gap value specified for the associated burst in the burst table.

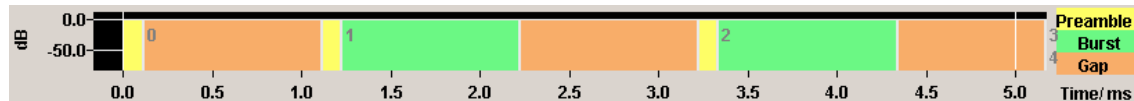

## Show Active Carriers OFDM - WiMAX

The Active Carrier graph is reached via the **Show Active Carrier...** button at the Bottom of the **Frame Configuration...** submenu.

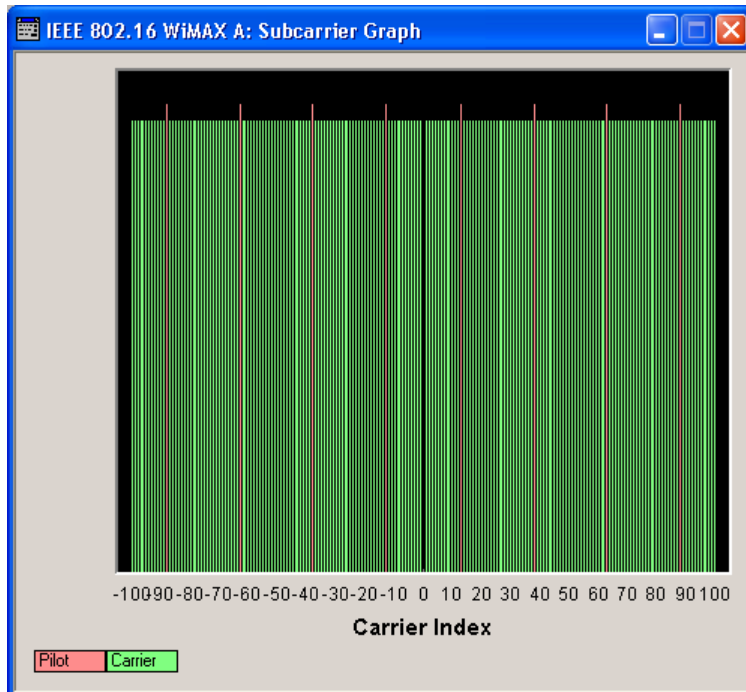

The graph shows used pilots and carriers of the current subchannelization mode. When subchannelization is activated by setting **No. of used Subchannels** to a value different than 16, the graph shows the used and blanked carriers according to the setting of **Subchannel Index**.

## FCH Configuration Downlink OFDM- WiMAX

The **FCH Configuration** menu is reached via the **Configure FCH..** button in the frame configuration menu. The FCH is only available in downlink mode. The following describes the FCH options in OFDM mode.

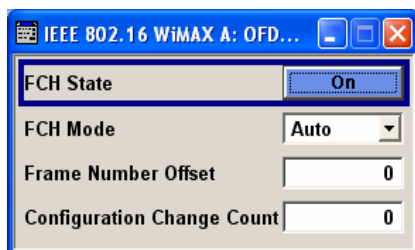

**FCH State OFDM - WiMAX** Switches the FCH on or off.

Remote-control command :

SOUR:BB:WIM:OFDM:FCH:STAT ON

**FCH Mode OFDM - WiMAX** Selects the mode for generating the FCH. Channel Coding of the FCH is performed both in **Auto** and **User** mode.

**Auto**

In **Auto** mode, the DLFP (Downlink Frame Prefix) fields, which form the FCH, are filled automatically with parameters specified at different locations.

The following mapping applies in Auto mode:

**Base\_Station\_ID:**

Set to the BSID value specified in the frame configuration menu.

**Frame\_Number:**

Set to the current frame number modulo 16. The first frame of the generated sequence has the number specified in Frame Number Offset below. For the following frames, this number will increase by 1 per frame.

**Configuration\_Change\_Count:**

Set to the value specified below.

**Rate\_ID:**

The Rate ID parameter of the first burst is set according to its modulation setting.

**DIUC:**

The DIUC value for the second, third and fourth burst is taken from the DIUC value in the burst table.

**Preamble Present:**

Set to 1 when the burst preamble is activated for the corresponding burst.

**Length:**

Set to the calculated number of symbols of the corresponding burst.

**HCS:**

The Header Check Sequence is automatically calculated.

**Remote-control command:**

SOUR:BB:WIM:OFDM:FCH:MODE AUTO

**User**

In **User** mode, the FCH is filled with data specified under Data Source. This enables any arbitrary data to be sent with the FCH burst.

**Remote-control command:**

SOUR:BB:WIM:OFDM:FCH:MODE USER

<b>Frame Number Offset FCH OFDM - WiMAX</b>	<p>Sets the frame number offset.</p> <p>This value is added to the current frame number of the sequence. After modulo 16 division, the result is used as Frame_Number in the FCH (in Auto mode) and is also used to initialize the randomizers.</p> <p>Remote-control command: SOUR:BB:WIM:OFDM:FCH:FNOF 14</p>
<b>Configuration Change Count FCH OFDM - WiMAX</b>	<p>Sets the configuration change count value.</p> <p>This value is used for the corresponding FCH field in Auto mode.</p> <p>Remote-control command: SOUR:BB:WIM:OFDM:FCH:CCC 14</p>
<b>Data Source FCH OFDM - WiMAX</b>	<p>Specifies the data source in User mode. The FCH contents are filled from the selected data source.</p> <p>The data sources <b>PN9, PN11, PN15, PN16, PN20, PN21, PN23, ALL 0, ALL1, Pattern</b> and <b>Data List</b> are all available to choose from.</p> <p><b>Data lists</b> can be generated internally in the data editor or externally. Data lists are selected in the <b>File Select</b> window, which is called by means of the <b>Data List Management</b> button.</p> <p>If the <b>Pattern</b> data type is used, the bit pattern is defined in the <b>Pattern</b> input box. The length is limited to 64 bits.</p> <p>Remote-control command: SOUR:BB:WIM:OFDM:FCH:DATA PATT SOUR:BB:WIM:OFDM:FCH:DATA:PATT #H3F, 8</p> <p>SOUR:BB:WIM:OFDM:FCH:DATA DLIS SOUR:BB:WIM:OFDM:FCH:DATA:DSEL "FCH"</p>

## Generate UL-MAP Uplink OFDM- WiMAX

The **Generate UL-MAP** menu is reached via the **Generate UL-MAP..** button in the frame configuration menu.

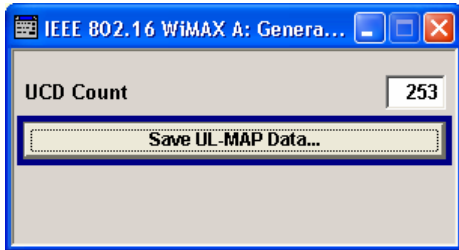

**UCD Count OFDM - WiMAX** Sets the value for the UCD count.

Remote-control command :

SOUR:BB:WIM:OFDM:UCD 253

**Save UL-MAP Data OFDM - WiMAX** Opens the **File Select** window for saving the current UL-map.

The name of the file is specified in the **File name** entry field, the directory selected in the **save into** field. The file is saved by pressing the **Save** button.

The file is stored with the predefined file extension **\*.dm\_iqd**. The file name and the directory it is stored in are user-definable.

The saved **\*.dm\_iqd** file is in the data list format and contains a UL-MAP that describes the current uplink subframe. The UL-MAP is composed of the following parameters:

UCD Count:

Set to UCD Count specified above.

Allocation Start Time:

Set to 0. Can be modified later when loading the UL-MAP in downlink mode

CID:

CID from the More Params panel for each burst

Start Time:

Burst start in OFDM symbols for each burst

Subchannel Index:

Subchannel Index set in the Frame Configuration panel

UIUC:

UIUC from the More Params panel for each burst

Duration:

Burst duration in symbols

Midamble repetition interval:

Midamble repetition for each burst



The following steps are required to generate a valid UL-MAP

1. Switch to uplink mode
2. Define the layout of the uplink subframe by setting a number of bursts and specifying the parameters above for each burst
3. Select Generate UL-MAP and save the UL-MAP to a file
4. Switch to downlink mode
5. Set one of the downlink bursts to Burst Type UL-MAP
6. Open the More Params Panel
7. Select UL-MAP File and load the file created before.

The downlink frame is then transmitting a UL-MAP that specifies the uplink structure defined in uplink mode before.

Remote-control command:

```
SOUR:BB:WIM:OFDM:ULM:CRE 'ul-map_zone1'
```

## UL-MAP Downlink OFDM- WiMAX

The **UL-MAP** menu is reached via the More Params button in the OFDM burst table.

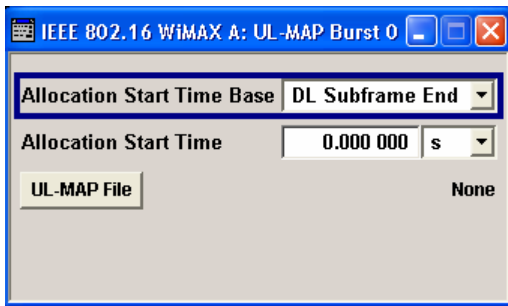

### Allocation Start Time Base - WiMAX

Selects the Allocation Start Time base. The Allocation Start Time field of the UL-MAP specifies the start of the uplink subframe. When Start Time Base is set to DL Subframe End, the Allocation Start Time of the UL-MAP is set to the end of the downlink subframe + the Allocation Start Time parameter set below. When Start Time Base is set to Frame Start, the Allocation Start Time of the UL-MAP is set to the beginning of the frame + the Allocation Start Time parameter set below.

Remote-control command:

```
SOUR:BB:WIM:OFDM:BURS2:ULM:AMOD DLSF
```

### Allocation Start Time - WiMAX

Sets the Allocation Start Time in the UL-MAP

Remote-control command:

```
SOUR:BB:WIM:OFDM:BURS2:ULM:ATIM 0.001
```

### UL-MAP File - WiMAX

Calls the menu for selecting the UL-map file.

Remote-control command:n.a.

## More Parameters Uplink OFDM- WiMAX

The **More parameters** menu is reached via the OFDM burst table.

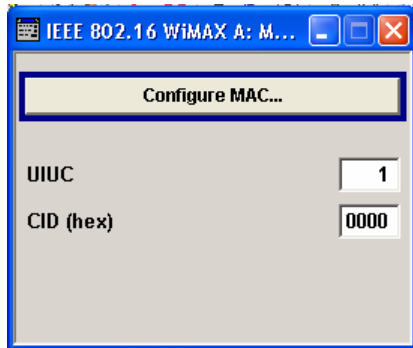

### Configure MAC - WiMAX

Calls the menu for configuring the Mac header panel for the selected burst.

Remote-control command:n.a.

### UIUC OFDMA - WiMAX

Sets the specific UIUC.

Remote-control command:

SOUR:BB:WIM:OFDM:BURS2:DIUC 2

### MAC CID - WiMAX

The command sets the CID (connection control identifier) of the medium access control layer (MAC). The CID identifies a connection to equivalent peers in the MAC of the base station and subscriber station.

Remote-control command:

SOUR:BB:WIM:OFDM:BURS2:MAC:CID #H333

## MAC Header Configuration OFDM - WiMAX

The **MAC** menu is reached via the **Configure MAC...** button of the **More Parametres** menu of the burst table.

This menu provides settings for a generic MAC header, which is placed at the beginning of the burst when activated.

In addition CRC (cyclic redundancy check) can be activated, which is added at the end of the burst. It covers MAC header and all data.

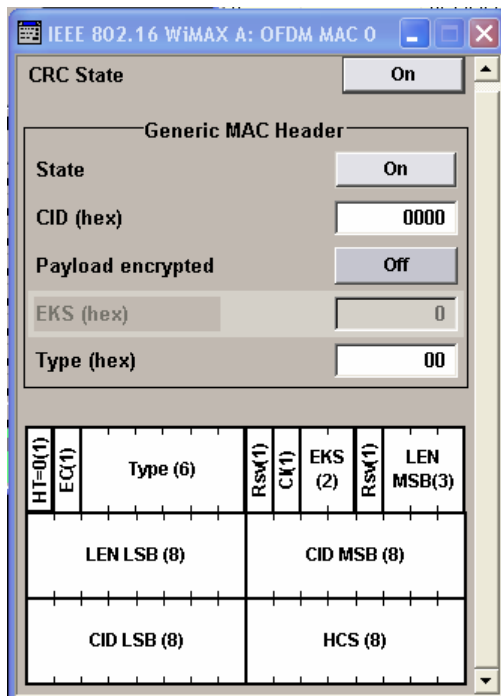

### CRC State - WiMAX

Activates/deactivates the checksum determination. The state of the CRC can be set independently of the state of MAC header generation.

Remote-control command

```
SOUR:BB:WIM:OFDM:BURS2:MAC:CRC:STAT ON
```

The **Generic MAC Header** section is where the header generation is activated and the header parameters are defined.

**MAC Header State - WiMAX** Activates the generation of the generic MAC header.

Remote-control command:

```
SOUR:BB:WIM:OFDM:BURS2:MAC:STAT ON
```

**MAC CID - WiMAX**

The command sets the CID (connection control identifier) of the medium access control layer (MAC). The CID identifies a connection to equivalent peers in the MAC of the base station and subscriber station.

Remote-control command:

```
SOUR:BB:WIM:OFDM:BURS2:MAC:CID #H333
```

**Payload encrypted - WiMAX**

Activates/disactivates payload encryption.

If activated, the EC (encryption control) field is set to 1 and the EKS (encryption key sequence) field can be set.

Remote-control command:

```
SOUR:BB:WIM:OFDM:BURS2:MAC:ENCR:STAT ON
```

**EKS - WiMAX**

Sets the EKS (encryption key sequence) value in the MAC header. The payload encryption itself is not performed by the signal generator.

Remote-control command:

```
SOUR:BB:WIM:OFDM:BURS2:MAC:EKS 4
```

**Mac Type - WiMAX**

Specifies the MAC type.

The value of the 6-bit type field is set which indicates the payload type, including the presence of subheaders.

Remote-control command:

```
SOUR:BB:WIM:OFDM:BURS2:MAC:TYPE #H333
```

## Frame Configuration OFDMA - WiMAX

This menu provides all parameters to configure frames in OFDMA mode.

Zone Number	Zone Type	Segment	No. Of Symbols	Auto	Offset Symbol	PermBase	PRBS_ID	Configure Zone	
0	0	PUSC	0	2	On	1	0	0	Config...
1	0	PUSC	0	2	On	1	0	0	Config...
2	0	PUSC	0	2	On	1	0	0	Config...
3	0	PUSC	0	2	On	1	0	0	Config...
4	0	PUSC	0	2	On	1	0	0	Config...
5	0	PUSC	0	2	On	1	0	0	Config...
6	0	PUSC	0	2	On	1	0	0	Config...
7	0	PUSC	0	2	On	1	0	0	Config...

### Frequency Band OFDMA-WiMAX

Selects the frequency band for the carrier frequencies. The available ranges for setting the channel bandwidth and the sampling rate depend on the selection here.

#### ETSI

The frequency band as defined by the **European Telecommunications Standards Institute** applies.

The range is 1.75 to 28 MHz for the channel bandwidth and 2 to 32 MHz for the sampling rate.

Remote-control command:

SOUR:BB:WIM:AOFD:FBAN ETSI

#### MMDS

The frequency band as defined by the **Multichannel Multipoint Distribution Service** applies. The RF frequency range is 2500 to 2686 MHz.

The range is 1.50 to 24 MHz for the channel bandwidth and 1.68 to 26.88 MHz for the sampling rate.

Remote-control command:

SOUR:BB:WIM:AOFD:FBAN MMDS

<b>WCS</b>	<p>The frequency band as defined by the <b>Wireless Communication Service</b> applies. It is in the 2.3 GHz band of the electromagnetic spectrum from 2305 to 2320 MHz and 2345 to 2360 MHz.</p> <p>The range is 2.5 to 15 MHz for the channel bandwidth and 2.8 to 16.8 MHz for the sampling rate.</p> <p>Remote-control command: SOUR:BB:WIM:AOFD:FBAN WCS</p>
<b>U-NII</b>	<p>The frequency band as defined by the <b>Unlicensed National Information Infrastructure</b> applies. It is in the 5 GHz band of the electromagnetic spectrum from 5150 to 5350 GHz and 5750 to 5825 GHz.</p> <p>The range is 10 to 20 MHz for the channel bandwidth and 11.2 to 22 MHz for the sampling rate.</p> <p>Remote-control command: SOUR:BB:WIM:AOFD:FBAN UNII</p>
<b>WiBro</b>	<p>The frequency band as defined by the <b>Telecommunications Technology Association of Korea</b>. It is in the 2.3 GHz band of the electromagnetic spectrum.</p> <p>Remote-control command: SOUR:BB:WIM:AOFDM:FBAN WIBR</p>
<b>User</b>	<p>This mode is provided for choosing any other channel bandwidth / sampling rate combination.</p> <p>The range is 1.25 to 28 MHz for the channel bandwidth and 1.4 to 32 MHz for the sampling rate.</p> <p>Remote-control command: SOUR:BB:WIM:AOFD:FBAN USER</p>

**Channel Bandwidth  
OFDMA - WiMAX**

Sets the channel bandwidth. The range is 1.25 to 28 MHz.

The selected channel bandwidth has to be a multiple of 1.25, 1.5, 1.75, 2.0 or 2.75 MHz. The channel bandwidth determines the parameter n (sampling ratio, see below):

For channel bandwidths

that are a multiple of 1.75 MHz then  $n = 8/7$

that are a multiple of 1.5 MHz then  $n = 28/25$

that are a multiple of 1.25 MHz then  $n = 28/25$

that are a multiple of 2.75 MHz then  $n = 28/25$

that are a multiple of 2.0 MHz then  $n = 28/25$

else for channel bandwidths not otherwise specified then  $n = 8/7$

The sampling rate is derived from the channel bandwidth as follows:

$\text{SamplingRate} = \text{floor}(n * \text{ChannelBandwidth} / 8000) * 8000$

Remote-control command:

SOUR:BB:WIM:AOFD:BW 14 MHz

**Sampling Ratio n OFDMA -  
WiMAX**

Indicates the sampling ratio. The sampling ratio is determined by the channel bandwidth (see above, parameter **Channel Bandwidth**

Remote-control command:

SOUR:BB:WIM:AOFD:N?

**Sampling Rate OFDMA -  
WiMAX**

Sets the sampling rate. The possible settings depend on the selected frequency band. The full range in **User** mode is 1.44 to 32 MHz.

The sampling rate is related to the channel bandwidth by the parameter n:

$\text{SamplingRate} = \text{floor}(n * \text{ChannelBandwidth} / 8000) * 8000$

Remote-control command:

SOUR:BB:WIM:AOFD:SRAT 2 MHz

**Number of  
Zones/Segments OFDMA -  
WiMAX**

Sets the number of active zones/segments in one frame.

Remote-control command:

SOUR:BB:WIM:AOFD:ZONE:COUN 2

<b>Preamble Mode OFDMA - WiMAX</b>	<p>Selects the mode for selecting the preamble index.</p> <p><b>Auto</b>                      The preamble index value is automatically derived from the segments used in the first zone (see <a href="#">“Configure active Subchannels OFDMA - WiMAX”</a>) and the IDcell parameter. The Preamble Index field below shows the used preamble index. If more than one segment is active in the first zone, the Preamble Index shows -1. In this case, a multi-segment preamble is generated.</p> <p>Remote-control command: SOUR:BB:WIM:AOFD:PRE:IND:MODE AUTO</p> <p><b>User</b>                        Sets the preamble index to one of the available indices from 1 to 113 specified in the <b>Preamble Index</b> field.</p> <p>Remote-control command: SOUR:BB:WIM:AOFD:PRE:IND:MODE USER</p>
<b>Preamble Index OFDMA - WiMAX</b>	<p>Sets the preamble index to one of the available indices from 1 to 113 in preamble mode “user”.</p> <p>Remote-control command: SOUR:BB:WIM:AOFD:PRE:IND 12</p>
<b>Tg/Tb Ratio OFDMA - WiMAX</b>	<p>Selects the ratio of guard period to symbol period.</p> <p>This value sets the length of the cyclic prefix in fractions of the symbol period.</p> <p>Remote-control command: SOUR:BB:WIM:AOFD:TGTB TGTB1D16</p>
<b>FFT Size OFDMA - WiMAX</b>	<p>Selects the FFT size.</p> <p>Remote-control command: SOUR:BB:WIM:AOFD:FFT 2048</p>
<b>IDCell OFDMA - WiMAX</b>	<p>Sets the IDcell. The IDcell is used in the preamble, as PermBase parameter for the permutation equations in the first downlink zone and partly sets the subcarrier randomizer initialisation vector in the first downlink zone.</p> <p>Remote-control command: SOUR:BB:WIM:AOFD:IDC 4</p>
<b>Show Time Plan OFDMA - WiMAX</b>	<p>Calls the graphical display of the OFDMA Time Plan (see Section <a href="#">Time Plan - WiMAX</a>, page 4.651).</p> <p>Remote-control command: n.a.</p>



## Time Plan - WiMAX

The time plan indicates the assignment of the active bursts. The x-axis shows the OFDMA symbol number relative to frame/zone start on the top of the diagram and the time in ms relative to frame/zone start on the bottom of the diagram. The vertical line on the right side shows the frame boundary. The y-axis indicates the physical/logical subchannel numbers.

The bursts are numbered with ZoneIndex.BurstNumber in the time plan.

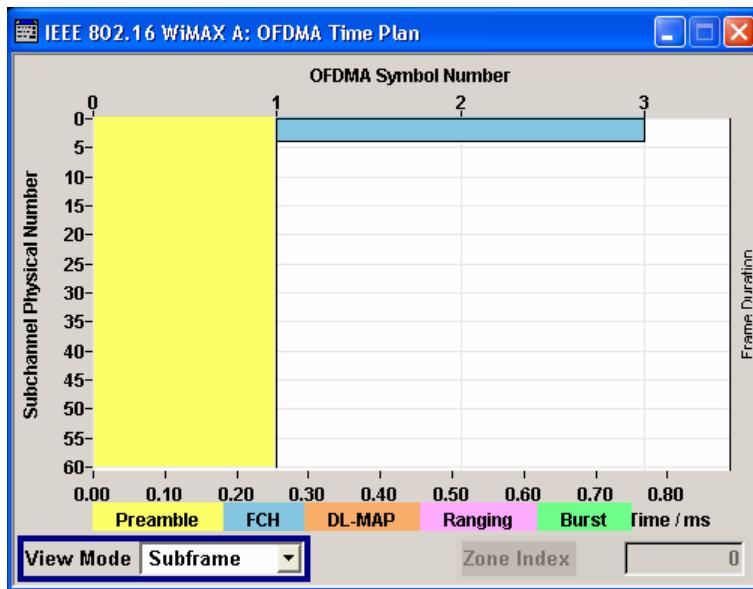

### Time Plan View Mode OFDMA - WiMAX

Selects the display range  
Remote-control command: n.a

**Total Frame** The display range extends to all zones including the gap to the frame duration. The y-axis shows the physical subchannels. All logical subchannels are mapped to physical before display. In uplink mode, the data subchannel rotation is not displayed.

**Subframe** The display range is zoomed to the subframe of the corresponding link direction.

**Zone** The display range is zoomed to the selected zone index. The y-axis shows the logical subchannels of the zone/segment.

### Time Plan Zone Index OFDMA - WiMAX

Selects the zone index to be displayed.

This feature is only available, if **Zone** is selected in the **View Mode** field.

Remote-control command: n.a

## Zone Table OFDMA- WiMAX

The **zone table** is located in the lower part of the menu. The zone table is where the individual zone parameters are set.

	Zone Number	Zone Type	Segment	No. Of Symbols	Auto	Offset Symbol	PermBase	PRBS_ID	Configure Zone
0	0	PUSC	0	2	On	1	0	0	Config...
1	0	PUSC	0	2	On	1	0	0	Config...
2	0	PUSC	0	2	On	1	0	0	Config...
3	0	PUSC	0	2	On	1	0	0	Config...
4	0	PUSC	0	2	On	1	0	0	Config...
5	0	PUSC	0	2	On	1	0	0	Config...
6	0	PUSC	0	2	On	1	0	0	Config...
7	0	PUSC	0	2	On	1	0	0	Config...

### Zone Index OFDMA - WiMAX

Displays the consecutive zone index from 0 to 7.

Remote-control command: n.a.

(selected via the suffix to the keyword :BURSt<n> )

### Zone Number OFDMA - WiMAX

Sets the zone number of the zone. The value range is 0 to 7. Zones are generated in the order of zone number, the lowest zone number is generated first. If the same zone number is applied to more than one row, different segments can be used within one zone. In this case, the segment numbers must differ and the activated subchannels of the segments must not overlap.

Remote-control command:

SOUR:BB:WIM:AOFD:ZONE0:NUMB 5

### Zone Type OFDMA - WiMAX

Selects the type of subcarrier permutation for the zone.

Remote-control command:

SOUR:BB:WIM:AOFD:ZONE0:TYPE FUSC

### Segment OFDMA - WiMAX

Selects the segment of the zone index. Multiple segments within one zone can be configured by setting the same zone number and configuring different segment numbers for each zone index. The activated subchannels must not overlap between the segments of one zone.

Remote-control command: n.a.

SOUR:BB:WIM:AOFD:ZONE1:SEGM2

### No. Of Symbols OFDMA - WiMAX

Sets the zone length in number of symbols. Zones with identical zone number have the same length, as they overlap in time.

Remote-control command:

SOUR:BB:WIM:AOFD:ZONE1:SYMB:COUN 3

---

<b>Auto OFDMA - WiMAX</b>	Activates or deactivates automatic zone length. In auto mode, the number of symbols in the zone is derived from the configured bursts such that all bursts fit into the zone, except if the frame duration is exceeded.  Remote-control command: SOUR:BB:WIM:AOFD:ZONE1:SYMB:COUN:AUTO ON
<b>Offset Symbol OFDMA - WiMAX</b>	Displays the symbol offset of the zone.  Remote-control command: SOUR:BB:WIM:AOFD:ZONE1:SYMB:OFFs?
<b>PermBase OFDMA - WiMAX</b>	Selects the PermBase of the zone.  Remote-control command: SOUR:BB:WIM:AOFD:ZONE1:PERM 5
<b>PRBS_ID OFDMA - WiMAX</b>	Selects the PRBS_ID of the zone.  Remote-control command: SOUR:BB:WIM:AOFD:ZONE1:PRBS 3
<b>Configure Zone OFDMA - WiMAX</b>	Calls the menu for configuring the parameters of the zone.  Remote-control command: n.a.

## Zone Configuration OFDMA - WiMAX

This menu provides all parameters to configure zones in OFDMA mode.

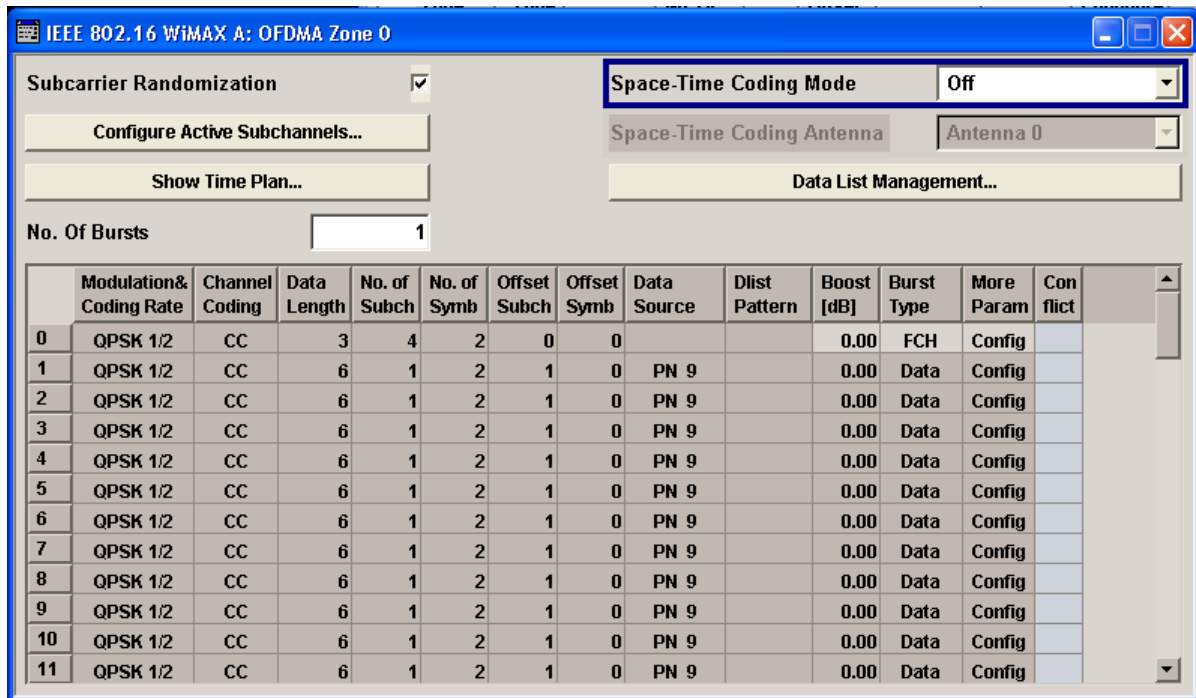

### No of Bursts OFDMA - WiMAX

Sets the number of active bursts in the zone/segment.

Remote-control command:

SOUR:BB:WIM:AOFD:ZONE0:BURS2:COUN 2

### Space-Time Coding Mode OFDMA - WiMAX

Sets the space-time coding mode or switches diversity off.

Remote-control command:

SOUR:BB:WIM:AOFD:ZONE0:STC:MODE OFF

### Space-Timing Coding Antenna OFDMA - WiMAX

Sets the antenna for the space-timing coding.

Remote-control command:

SOUR:BB:WIM:AOFD:ZONE0:STC:ANT ANT0

<b>Subcarrier Randomization OFDMA - WiMAX</b>	<p>Activates or deactivates the subcarrier randomization. Subcarrier randomization is performed after PUSC/FUSC permutation and before IFFT conversion.</p> <p>Remote-control command: SOUR:BB:WIM:AOFD:SCAR:RAND ON</p>
<b>Configure active Subchannels OFDMA - WiMAX</b>	<p>Calls the menu for activating/deactivating subchannels.</p>
<b>Use All Subchannels</b>	<p>Activates the generation of all subchannels.</p> <p>Remote-control command: SOUR:BB:WIM:AOFD:ZONE0:SUBC:MODE ALL</p>
<b>Use Subchannels x...y (downlink PUSC only)</b>	<p>Activates the generation of the selected group(s) of subchannels.</p> <p>Remote-control command: SOUR:BB:WIM:AOFD:ZONE0:SUBC:MODE USER SOUR:BB:WIM:AOFD:ZONE0:SUBC2:MAP ON SOUR:BB:WIM:AOFD:ZONE0:SUBC3:MAP ON</p>
<b>Allocated Subchannels Bitmap (uplink only)</b>	<p>In uplink mode, each physical subchannel can be individually activated or deactivated. This is realized with a 9 byte field identical to the UL allocated subchannels bitmap in the UCD message. The bytes of the bitmap are read from left to right and specify the physical subchannels in LSB first order. The LSB of the first (most left) byte selects the physical subchannel 0.</p> <p>The same order applies for all FFT Sizes. Subchannel bitmap bits that are not needed in modes with less than 70 physical subchannels are discarded.</p> <p>Remote-control command: SOUR:BB:WIM:AOFD:ZONE0:SUBC:PATT #FFFFFFFFFFFFFFFF3F,72</p>
<b>Show Time Plan OFDMA - WiMAX</b>	<p>Calls the graphical display of the OFDMA Time Plan (see Section <a href="#">Time Plan - WiMAX</a>, page 4.685).</p> <p>Remote-control command: n.a.</p>
<b>Data List Management... - WiMAX</b>	<p>Calls the <b>Data List Management</b> menu. This menu is used to create and edit a data list.</p>
<b>Generate UL-MAP - WiMAX</b>	<p>Calls the menu for generating a UL-MAP.</p> <p>Remote-control command: n.a.</p>

## Burst Table OFDMA - WiMAX

The **burst table** is located in the lower part of the menu where individual burst parameters are set. A graphic display of the current burst locations in time and subchannel space can be viewed with the **Show Time Plan** button.

Each frame supports up to 64 bursts with individual parameters. For both transmission directions, different modulations and channel coding rates are available. For each burst, an optional generic MAC header and CRC is provided.

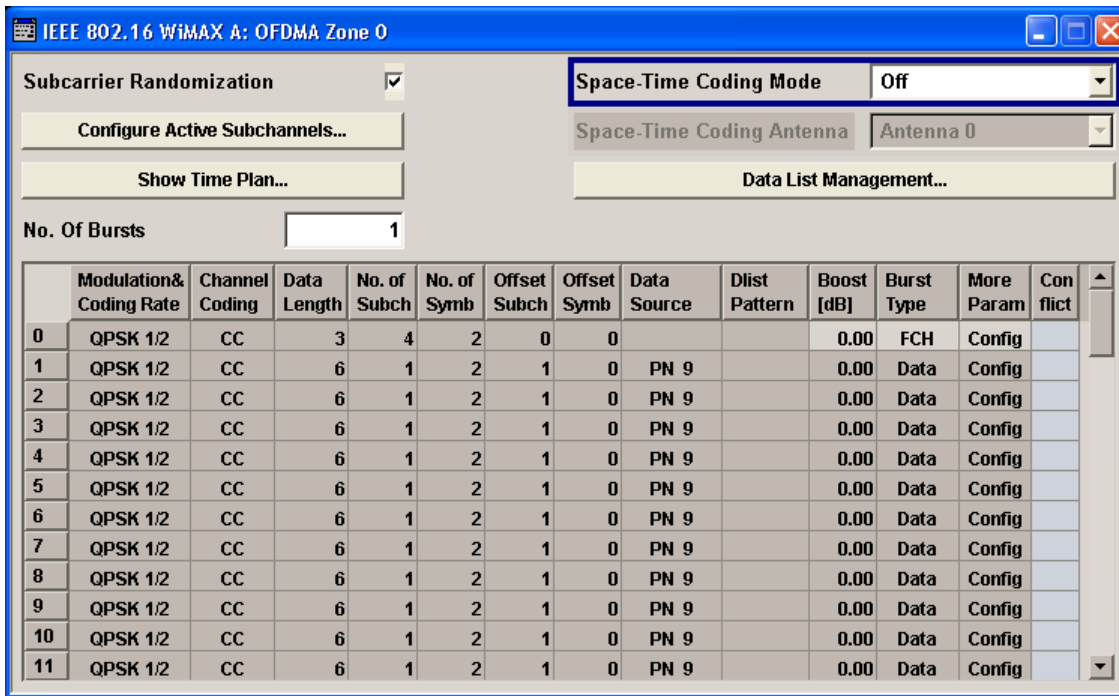

### Burst Index OFDMA - WiMAX

Displays the consecutive burst index from 0 to 63.

All the rows are always displayed, even if the bursts are inactive. They are switched on and off by the selection of **No. of Bursts** above the table. The active bursts are highlighted.

Remote-control command: n.a.

(selected via the suffix to the keyword :BURSt<n> )

### Modulation and Coding Rate OFDMA - WiMAX

Selects the modulation and channel coding rate. Channel coding includes randomization, convolutional/turbo coding and interleaving.

Remote-control command :

SOUR:BB:WIM:AOFD:ZONE0:BURS2:FORM QPSK1D2

<b>Channel Coding OFDMA - WiMAX</b>	<p>Selects the channel coding mode. Available modes are CC (convolutional coding), CTC (convolutional turbo coding) or Off. In Off mode, channel coding is switched off completely.</p> <p>Remote-control command:  <code>SOUR:BB:WIM:AOFD:ZONE0:BURS2:CCOD:MODE CC</code></p>
<b>Data Length OFDMA - WiMAX</b>	<p>Determines the data length in bytes.</p> <p>The given number of bytes is read from the data source. The total number of data bytes in the burst (before channel coding) is determined as follows:</p> <p><math>TotalDataBytes = DataLength + MACHeaderBytes + CRCBytes</math></p> <p>Additionally padding with 0xFF bytes is applied at the end of the data sequence to fill up the allocated slots specified by <b>No. of Subch</b> and <b>No. of Symb</b> in downlink mode and <b>Duration [Slots]</b> in uplink mode. Thus, the Data Length can be lower than the burst's allocated number of bytes.</p> <p>Up to 10 000 data bytes can be set for each burst.</p> <p>Remote-control command:  <code>SOUR:BB:WIM:AOFD:ZONE0:BURS2:DLEN 1000</code></p>
<b>Number of Subchannels OFDMA - WiMAX</b>	<p>Enters the number of subchannels for the selected burst. If the number of subchannels is changed, the data length is adjusted to fill the allocated space defined by <b>No. of Subch</b> and <b>No. of Symb</b> with data so that no padding has to be applied. The data length can be lowered afterwards if data bytes less than the allocated number shall be read from the data source.</p> <p>Remote-control command:  <code>SOUR:BB:WIM:AOFD:ZONE1:BURS2:SUBC:COUN 114</code></p>
<b>Number of Symbols OFDMA - WiMAX</b>	<p>Enters the number of symbols for the selected burst.</p> <p>If the number of symbols is changed, the data length is adjusted to fill the allocated space defined by <b>No. of Subch</b> and <b>No. of Symb</b> with data so that no padding has to be applied. The data length can be decreased afterwards if data bytes less than the allocated number shall be read from the data source. The entered number of symbols is automatically adjusted to a multiple of the number of symbols per slot for the set subcarrier permutation.</p> <p>Remote-control command:  <code>SOUR:BB:WIM:AOFD:ZONE0:BURS4:SYMB:COUN 14</code></p>
<b>Duration-Slots OFDMA - WiMAX</b>	<p>Enters the number of slots for the selected burst. If the number of slots is changed, the data length is adjusted to fill the specified number of slots with data so that no padding has to be applied.</p> <p>Remote-control command:  <code>SOUR:BB:WIM:AOFD:ZONE0:BURS3:SLOT:COUN 114</code></p>

**Offset Subchannel OFDMA - WiMAX**

Indicates the subchannel offset for the selected burst.

Remote-control command:

```
SOUR:BB:WIM:AOFD:ZONE0:BURS2:OFFS:MODE USER
SOUR:BB:WIM:AOFD:ZONE0:BURS2:OFFS:SUBC 7
```

**Offset Symbol OFDMA - WiMAX**

Indicates the symbol offset for the selected burst.

Remote-control command:

```
SOUR:BB:WIM:AOFD:ZONE0:BURS2:OFFS:MODE USER
SOUR:BB:WIM:AOFD:ZONE0:BURS2:OFFS:SYMB 2
```

**Data Source OFDMA - WiMAX**

Selects data source for the selected bursts.

The data sources **PN9**, **PN11**, **PN15**, **PN16**, **PN20**, **PN21**, **PN23**, **ALL 0**, **ALL1**, **Pattern** and **Data List** are all available to choose from.

**Data lists** can be generated internally in the data editor or externally.

Data lists are selected in the **File Select** window, which is called by means of the **Data List Management** button.

If the **Pattern** data type is used, the bit pattern is defined in the **Pattern** input box. The length is limited to 64 bits.

Remote-control command

```
SOUR:BB:WIM:AOFD:ZONE0:BURS2:DATA PATT
SOUR:BB:WIM:AOFD:ZONE0:BURS2:DATA:PATT #H3F,8
```

```
SOUR:BB:WIM:AOFD:ZONE0:BURS2:DATA DLIS
```

```
SOUR:BB:WIM:AOFD:ZONE0:BURS2:DATA:DSEL "BS2_AOFD"
```

**Boost OFDMA - WiMAX**

Sets the burst power in dB. This setting affects the data tones only in downlink mode, the pilot power is fixed. In uplink, the setting affects both data and pilot tones.

Remote-control command:

```
SOUR:BB:WIM:AOFD:ZONE0:BURS2:POW -20
```

**Burst Type OFDMA - WiMAX**

Selects the burst type from Data, FCH, DL-MAP, UL-MAP or Ranging.

Remote-control command:

```
SOUR:BB:WIM:AOFDM:ZONE0:BURS2:TYPE DATA
```

**FCH**

An FCH is generated at subchannel and symbol offset 0. See "[FCH Configuration Downlink OFDMA - WiMAX](#)" below on the FCH contents.

Remote-control command:

```
SOUR:BB:WIM:AOFDM:ZONE0:BURS2:TYPE
DATA
```



<b>DL-MAP</b>	<p>A DL-MAP is generated, taking into account all active bursts. See "<a href="#">DL-MAP Configuration Downlink OFDMA - WiMAX</a>" below on the DL-MAP contents.</p> <p>Remote-control command: SOUR:BB:WIM:OFDM:BURS2:TYPE DLM</p>
<b>UL-MAP</b>	<p>A UL-MAP is generated using the specified data list, including additional parameters from the "More Params" panel. See "<a href="#">UL-MAP Configuration Downlink OFDMA - WiMAX</a>" for more information on how to create UL-MAP bursts</p> <p>Remote-control command: SOUR:BB:WIM:AOFDM:ZONE0:BURS2:TYPE ULM</p>
<b>Ranging</b>	<p>An uplink ranging channel is configured, which can be used for initial ranging, periodic ranging or bandwidth request transmissions.</p> <p>Remote-control command: SOUR:BB:WIM:AOFDM:ZONE0:BURS2:TYPE RANG</p>
<b>More Parameter OFDMA – WiMAX</b>	<p>Calls the menu for configuring additional parameters for the bursts. The menu depends on the selected burst type.</p> <p>Remote-control command: n.a.</p>
<b>Conflict OFDMA - WiMAX</b>	<p>Indicates a conflict between the settings of the bursts. Conflicts can occur if subchannel and symbol offsets are set manually and two or more bursts overlap. Bursts can also overlap with the FCH or DL-MAP. The position of FCH and DL-MAP is fixed and cannot be changed.</p> <p>Remote-control command: SOUR:BB:WIM:AOFDM:ZONE0:BURS2:CONF:STAT?</p>

## FCH Configuration Downlink OFDMA - WiMAX

The **FCH Configuration** menu is reached via the More Params button in the OFDMA burst table. The FCH is only available in downlink mode. The following describes the FCH options in OFDMA mode.

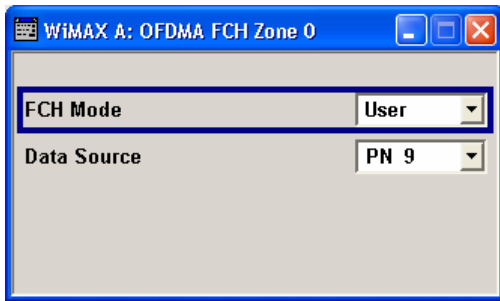

### FCH Mode OFDMA - WiMAX

Selects the mode for generating the FCH. Channel Coding of the FCH is performed both in **Auto** and **User** mode.

#### Auto

In **Auto** mode, the DLFP (Downlink Frame Prefix) fields, which form the FCH, are filled automatically with parameters specified at different locations.

The following mapping applies in Auto mode:

Used subchannel bitmap:

Set to the bitmap specified in the “Configure active Subchannels” panel.

Repetition\_Coding\_Indication:

Specifies the DL-MAP repetition coding set in the “Configure DL-MAP” panel.

Coding\_Indication:

Specifies channel coding of the DL-MAP (CC or CTC)

DL-Map\_Length:

Set to the number of slots allocated for the DL-MAP.

The FCH is transmitted with QPSK 1/2 and repetition coding of 4. For FFT Size 128 a reduced FCH is transmitted in one slot.

Remote-control command:

SOUR:BB:WIM:AOFD:ZONE0:FCH:MODE AUTO

#### User

In **User** mode, the FCH is filled with data specified under Data Source. This enables any arbitrary data to be sent with the FCH burst. 24 bits are read from the data source, these bits are repeated once to form 48 bits. The FCH is transmitted with QPSK 1/2 and repetition coding of 4. For FFT Size 128 a reduced FCH of size 12 bits is transmitted in one slot.

Remote-control command:

SOUR:BB:WIM:AOFD:ZONE0:FCH:MODE USER

**Data Source FCH OFDMA - WiMAX**

Specifies the data source in User mode.  
 The FCH contents are filled from the selected data source.  
 The data sources **PN9, PN11, PN15, PN16, PN20, PN21, PN23, ALL 0, ALL1, Pattern** and **Data List** are all available to choose from.  
**Data lists** can be generated internally in the data editor or externally.  
 Data lists are selected in the **File Select** window, which is called by means of the **Data List Management** button.

If the **Pattern** data type is used, the bit pattern is defined in the **Pattern** input box. The length is limited to 64 bits.

Remote-control command

```
SOUR:BB:WIM:AOFD:ZONE0:BURS2:DATA PATT
SOUR:BB:WIM:AOFD:ZONE0:BURS2:DATA:PATT #H3F,8

SOUR:BB:WIM:AOFD:ZONE0:BURS2:DATA DLIS
SOUR:BB:WIM:AOFD:ZONE0:BURS2:DATA:DSEL "BS2_AOFD"
```

## DL-MAP Configuration Downlink OFDMA - WiMAX

The DL-MAP **Configuration** menu is reached via the More Params button in the OFDMA burst table. The DL-MAP is only available in OFDMA downlink mode.

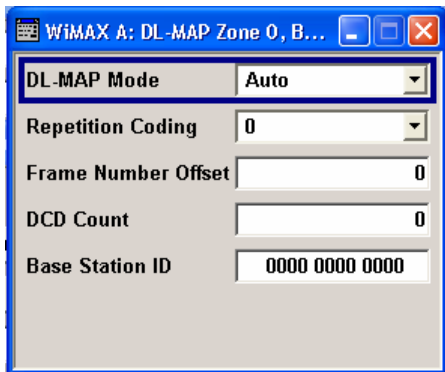

**DL-MAP Mode OFDMA - WiMAX**

Selects the mode for generating the DL-MAP.  
 Channel Coding of the DL-MAP is performed both in **Auto** and **User** mode.

**Auto**

In **Auto** mode, the DL-MAP is filled automatically with parameters specified at different locations.

The following mapping applies in Auto mode:

Frame Duration Code:

Specified by the Frame Duration set in the WiMAX main panel.

Frame Number:

Starts with the value specified by "Frame Number Offset" in the first generated frame and advances by 1 in every following frame.

DCD Count:

Directly set by the "DCD Count" field.

Base Station ID:

48 bits specified by the "Base Station ID" field.

No. OFDMA symbols:

Set to the total number of OFDMA symbols in all downlink zones

*For each burst:*

DIUC:

Set to the "DIUC" field in the More Params Panel.

OFDMA Symbol offset:

Set to "Offset Symb" +1.

Subchannel offset:

Set to "Offset Subch" of the burst table.

Boosting:

Depends on the "Boost" setting of the corresponding burst. The following mapping applies:

000: 0dB

001: +6dB

010: -6dB

011: +9dB

100: +3dB

101: -3dB

110: -9dB

111: -12dB

000 is set if any other value is specified for "Boost".

No. OFDMA Symbols:

Set to "No. of Symb" of the burst table.

No. Subchannels:

Set to "No. of Subch" of the burst table.

Repetition Coding Indication:

Set to Repetition Coding in the More Params Panel.

Remote-control command:

SOUR:BB:WIM:AOFD:ZONE0:DLM:MODE AUTO

<b>User</b>	<p>In <b>User</b> mode, the DL-MAP is filled with data specified under Data Source. This enables any arbitrary data to be sent with the DL-MAP burst.</p> <p>Remote-control command:  SOUR:BB:WIM:AOFD:ZONE0:DLM:MODE USER</p>
<b>DL-MAP Repetition Coding OFDMA - WiMAX</b>	<p>Repetition coding can be activated for the DL-MAP by specifying any value other than 0.</p> <p>Remote-control command:  SOUR:BB:WIM:AOFD:ZONE0:DLM:REPC RC0</p>
<b>Frame Number Offset DL-MAP OFDMA - WiMAX</b>	<p>Sets the frame number offset.</p> <p>This value is added to the current frame number of the sequence. The result is used as Frame Number in the DL-MAP (in Auto mode).</p> <p>Remote-control command:  SOUR:BB:WIM:AOFD:ZONE0:DLM:FNOF 556</p>
<b>DCD Count DL-MAP OFDMA - WiMAX</b>	<p>Sets the DCD count value.</p> <p>This value is used for the corresponding DL-MAP field in Auto mode.</p> <p>Remote-control command:  SOUR:BB:WIM:AOFD:DLM:DCD:COUN 12</p>
<b>Base Station ID OFDMA - WiMAX</b>	<p>Sets the Base Station ID.</p> <p>This value is used for the corresponding DL-MAP field in Auto mode.</p> <p>Remote-control command:  SOUR:BB:WIM:AOFD:DLM:BSID #H2322222222FF,48</p>
<b>Configure MAC OFDMA - WiMAX</b>	<p>Calls the menu for configuring the Mac header panel for the DL-MAP.</p> <p>Remote-control command:n.a.</p>

## Data Configuration OFDMA - WiMAX

The Data **Configuration** menu is reached via the **More Params** button in the OFDMA burst table.

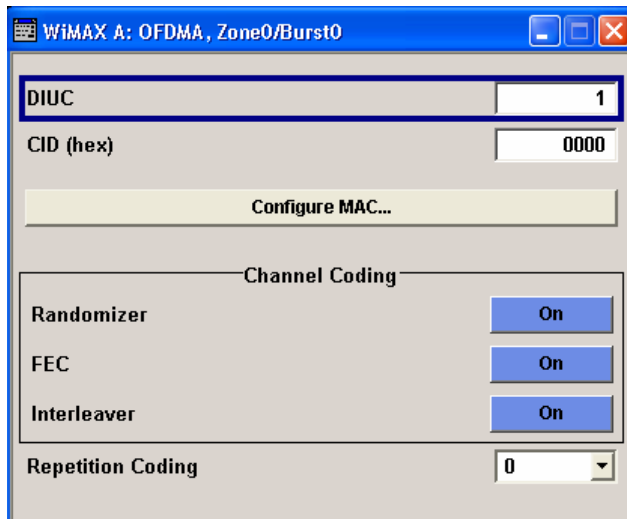

### DIUC OFDMA - WiMAX

**(This feature is only available in downlink direction.)**

Sets the specific DIUC.

In DL-MAP mode **Auto**, the DIUC of each burst is included in the DL-MAP.

Remote-control command:

```
SOUR:BB:WIM:AOFDM:ZONE0:BURS2:DIUC 2
```

### UIUC OFDMA - WiMAX

**(This feature is only available in uplink direction.)**

Sets the specific UIUC. The UIUC is used for the UL-MAP, if generated.

Remote-control command:

```
SOUR:BB:WIM:AOFDM:ZONE0:BURS2:UIUC 2
```

### MAC CID - WiMAX

The command sets the CID (connection control identifier) of the medium access control layer (MAC). The CID identifies a connection to equivalent peers in the MAC of the base station and subscriber station.

Remote-control command:

```
SOUR:BB:WIM:AOFDM:ZONE0:BURS2:MAC:CID #H333
```

- Configure MAC - WiMAX**      Calls the menu for configuring the Mac header panel for the selected burst.  
Remote-control command:n.a.
  
- Channel Coding Randomizer - WiMAX**      Activates or deactivates the randomizer applied before channel coding.  
Remote-control command:  
SOUR:BB:WIM:AOFD:ZONE0:BURS2:CCOD:RAND ON
  
- FEC - WiMAX**      Activates or deactivates the FEC.  
Remote-control command:  
SOUR:BB:WIM:AOFD:ZONE0:BURS2:CCOD:FEC ON
  
- Interleaver - WiMAX**      Activates or deactivates the interleaver state.  
Remote-control command:  
SOUR:BB:WIM:AOFD:ZONE0:BURS2:CCOD:INT ON
  
- Repetition Coding - WiMAX**      Activates repetition coding by specifying any value other than 0.  
Remote-control command:  
SOUR:BB:WIM:AOFD:ZONE0:BURS2:CCOD:REPC REP4

## UL-MAP Configuration Downlink OFDMA - WiMAX

The UL-MAP Configuration menu is reached via the More Params button in the OFDMA burst table.

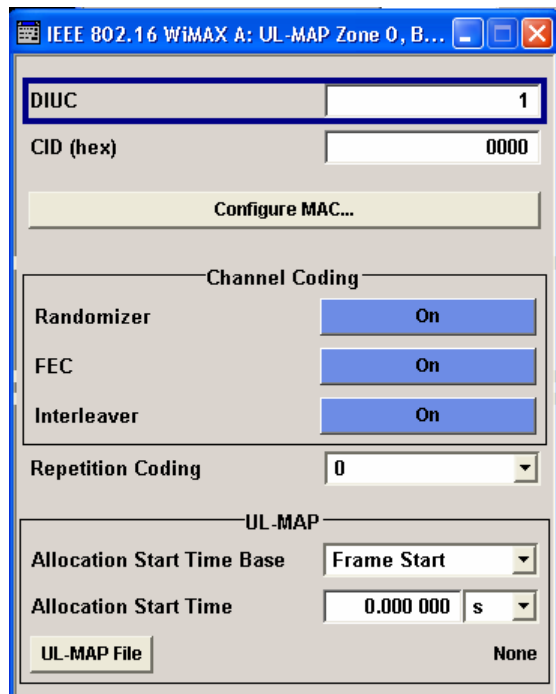

<b>DIUC OFDMA - WiMAX</b>	<p>Sets the specific DIUC. In DL-MAP mode <b>Auto</b>, the DIUC of each burst is included in the DL-MAP.</p> <p>Remote-control command:  SOUR:BB:WIM:AOFDM:ZONE0:BURS2:DIUC 2</p>
<b>MAC CID - WiMAX</b>	<p>The command sets the CID (connection control identifier) of the medium access control layer (MAC). The CID identifies a connection to equivalent peers in the MAC of the base station and subscriber station.</p> <p>Remote-control command:  SOUR:BB:WIM:AOFD:ZONE0:BURS2:MAC:CID #H333</p>
<b>Configure MAC - WiMAX</b>	<p>Calls the menu for configuring the Mac header panel for the selected burst.</p> <p>Remote-control command:n.a.</p>
<b>Channel Coding Randomizer - WiMAX</b>	<p>Activates or deactivates the randomizer applied before channel coding.</p> <p>Remote-control command:  SOUR:BB:WIM:AOFD:ZONE0:BURS2:CCOD:RAND ON</p>
<b>FEC - WiMAX</b>	<p>Activates or deactivates the FEC state.</p> <p>Remote-control command:  SOUR:BB:WIM:AOFD:ZONE0:BURS2:CCOD:FEC ON</p>
<b>Interleaver - WiMAX</b>	<p>Activates or deactivates the interleaver state.</p> <p>Remote-control command:  SOUR:BB:WIM:AOFD:ZONE0:BURS2:CCOD:INT ON</p>
<b>Repetition Coding - WiMAX</b>	<p>Repetition coding can be activated by specifying any value other than 0.</p> <p>Remote-control command:n.a.  SOUR:BB:WIM:AOFD:ZONE0:BURS2:CCOD:REPC REP4</p>



**Allocation Start Time Base - WiMAX**

Selects the Allocation Start Time base. The Allocation Start Time field of the UL-MAP specifies the start of the uplink subframe.

When Start Time Base is set to DL Subframe End, the Allocation Start Time of the UL-MAP is set to the end of the downlink subframe + Allocation Start Time parameter set below.

When Start Time Base is set to Frame Start, the Allocation Start Time of the UL-MAP is set to the beginning of the frame + Allocation Start Time parameter set below.

Remote-control command:

SOUR:BB:WIM:AOFD:ZONE0:BURS2:ULM:AMOD DLSF

**Allocation Start Time - WiMAX**

Sets the Allocation Start Time in the UL-MAP.

Remote-control command:

SOUR:BB:WIM:AOFD:ZONE0:BURS2:ULM:ATIM 0.001

**UL-MAP File - WiMAX**

Calls the menu for selecting the UL-map file.

Remote-control command:n.a.

## Generate UL-MAP Uplink OFDMA- WiMAX

The **Generate UL-MAP** menu is reached via the **Generate UL-MAP..** button in the zone configuration menu.

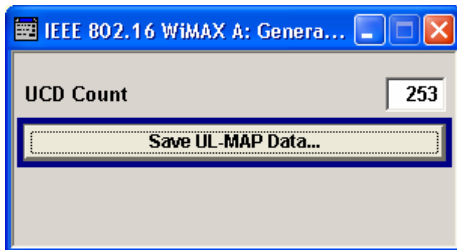
**UCD Count OFDMA - WiMAX**

Sets the value for the UCD count.

Remote-control command :

SOUR:BB:WIM:AOFD:ZONE0:UCD 253

**Save UL-MAP Data OFDMA- WiMAX**

Opens the **File Select** window for saving the current UL-map.

The name of the file is specified in the **File name** entry field, the directory selected in the **save into** field. The file is saved by pressing the **Save** button.

The file is stored with the predefined file extension **\*.dm\_iqd**. The file name and the directory it is stored in are user-definable.

The saved **\*.dm\_iqd** file is in data list format and contains a UL-MAP that describes the current uplink zone. The UL-MAP is composed of these parameters:

**UCD Count:**

Set to UCD Count specified above.

**Allocation Start Time:**

Set to 0. Can be modified later when loading the UL-MAP in downlink mode

**No. OFDMA Symbols:**

Total number of OFDMA symbols in the uplink subframe.

**CID:**

CID from the More Params panel for each burst

**UIUC:**

UIUC from the More Params panel for each burst or 12 for ranging.

**For ranging bursts:****OFDMA Symbol offset:**

Symbol offset relative to allocation starttime

**Subchannel offset:**

Lowest subchannel used for ranging allocation

**No. OFDMA symbols:**

Symbols in ranging allocation

**No. Subchannels:**

Subchannels in ranging allocation

**Ranging method:**

Defined by the Opportunity Size in the Ranging panel.

**For data bursts:****Duration:**

Burst duration in slots

**Repetition coding indication:**

Repetition coding from the More Params panel for each burst

The downlink zone is then transmitting a UL-MAP that specifies the uplink structure defined in uplink mode before.

The following steps are required to generate a valid UL-MAP

1. Switch to uplink mode
2. Define the layout of the uplink zone by setting a number of bursts and specifying the parameters above for each burst
3. Select Generate UL-MAP and save the UL-MAP to a file
4. Switch to downlink mode
5. Set one of the downlink bursts to Burst Type UL-MAP
6. Open the More Params Panel
7. Select UL-MAP File and load the file created before.

**Remote-control command:**

```
SOUR:BB:WIM:AOFD:ZONE0:ULM:CRE 'ulm'
```

## Ranging Uplink OFDMA - WiMAX

Burst type Ranging offers ranging allocations which can be used for initial / periodic ranging or bandwidth request transmissions. For each ranging / bandwidth request slot, 8 bits are read from the data source. These 8 bits select the used code. The codes are numbered from 0 to 255. For opportunity size 4, 8 bits are read once per slot. The first code is specified by the 8 bits and the second consecutive code is the first code advanced by one. For opportunity size 3, the same method is applied. The second code is the first code + 1, the third code is the first code + 2.

The **Ranging** menu is reached via the More Params button in the OFDMA burst table in uplink mode. The following describes the ranging options in OFDMA mode.

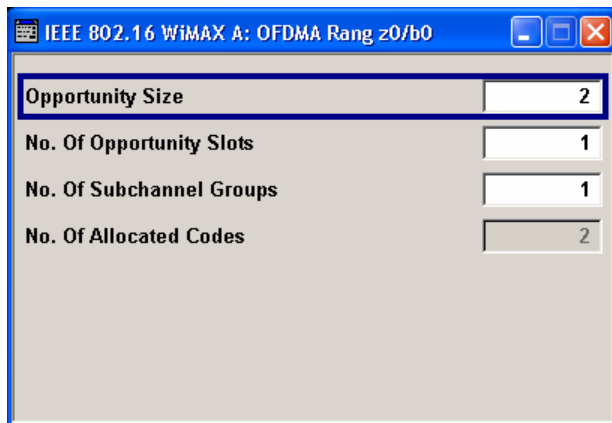

### Opportunity Size - WiMAX

Sets the ranging opportunity size. The opportunity size specifies the number of symbols required to transmit one CDMA ranging code.

For initial ranging transmissions, values of 2 or 4 are used. With opportunity size 2, one CDMA code is transmitted in two symbols. With opportunity size 4, two consecutive ranging codes are transmitted in four symbols.

For periodic ranging and bandwidth request transmissions, values of 1 or 3 are used. With opportunity size 1, one CDMA code is transmitted in one symbol. With opportunity size 3, three consecutive ranging codes are transmitted in three symbols.

Remote-control command :

```
SOUR:BB:WIM:AOFD:ZONE0:BURS2:RANG:OPP:SIZE 2
```

### No. Of Opportunity Slots - WiMAX

The number of opportunity slots defines the length of the ranging allocation, which is OpportunitySize \* NoOfOpportunitySlots OFDMA symbols.

Remote-control command:

```
SOUR:BB:WIM:AOFD:ZONE0:BURS2:RANG:OPP:SLOT 1
```

**No. Of Subchannel Groups - WiMAX** Sets the number of subchannel groups used in the ranging allocation. In PUSC mode, 6 subchannels form one subchannel group.

Remote-control command:  
 SOUR:BB:WIM:AOFD:ZONE0:BURS2:RANG:SCGC 5

**No. Of Allocated Codes - WiMAX** Displays the number of allocated codes. The number of codes is NoOfOpportunitySlots \* NoOfSubchannelGroups. Consecutive codes of opportunity sizes 3 and 4 are not taken into account.

Remote-control command:  
 SOUR:BB:WIM:AOFD:ZONE0:BURS2:RANG:ACOD?

## MAC Header Configuration OFDMA - WiMAX

The **MAC** menu is reached via the **Configure MAC...** button located in the More Params panel.

This menu provides settings for a generic MAC header, which is placed at the beginning of the burst when activated.

In addition CRC (cyclic redundancy check) can be activated, which is added at the end of the burst. It covers MAC header and all data.

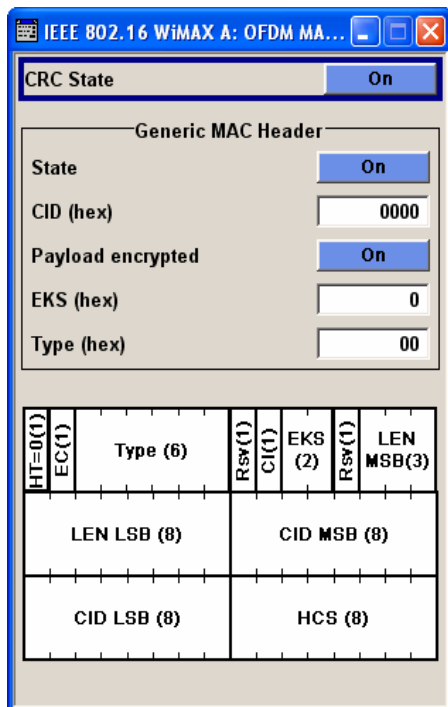

**CRC State - WiMAX**

Activates/deactivates the checksum determination. The state of the CRC can be set independently of the state of MAC header generation.

Remote-control command:

```
SOUR:BB:WIM:AOFD:ZONE0:BURS2:MAC:CRC:STAT ON
```

The **Generic MAC Header** section is where the header generation is activated and the header parameters are defined.

**MAC Header State - WiMAX** Activates the generation of the generic MAC header.

Remote-control command:

```
SOUR:BB:WIM:AOFD:ZONE0:BURS2:MAC:STAT ON
```

**MAC CID - WiMAX**

The command sets the CID (connection control identifier) of the medium access control layer (MAC). The CID identifies a connection to equivalent peers in the MAC of the base station and subscriber station.

Remote-control command:

```
SOUR:BB:WIM:AOFD:ZONE0:BURS2:MAC:CID #H333
```

**Payload encrypted - WiMAX**

Activates/disactivates payload encryption.

If activated, the EC (encryption control) field is set to 1 and the EKS (encryption key sequence) field can be set.

Remote-control command:

```
SOUR:BB:WIM:AOFD:ZONE0:BURS2:MAC:ENCR:STAT ON
```

**EKS - WiMAX**

Sets the EKS (encryption key sequence) value in the MAC header. The payload encryption itself is not performed by the signal generator.

Remote-control command:

```
SOUR:BB:WIM:AOFD:ZONE0:BURS2:MAC:EKS 4
```

**Mac Type - WiMAX**

Specifies the MAC type.

The value of the 6-bit type field is set which indicates the payload type, including the presence of subheaders.

Remote-control command:

```
SOUR:BB:WIM:AOFD:ZONE0:BURS2:MAC:TYPE #H333
```

## Filter / Clipping Settings - WiMAX

The **Filter / Clipping** menu is reached via the WiMAX main menu.

The baseband filter, sample rate variation and clipping are defined in this menu.

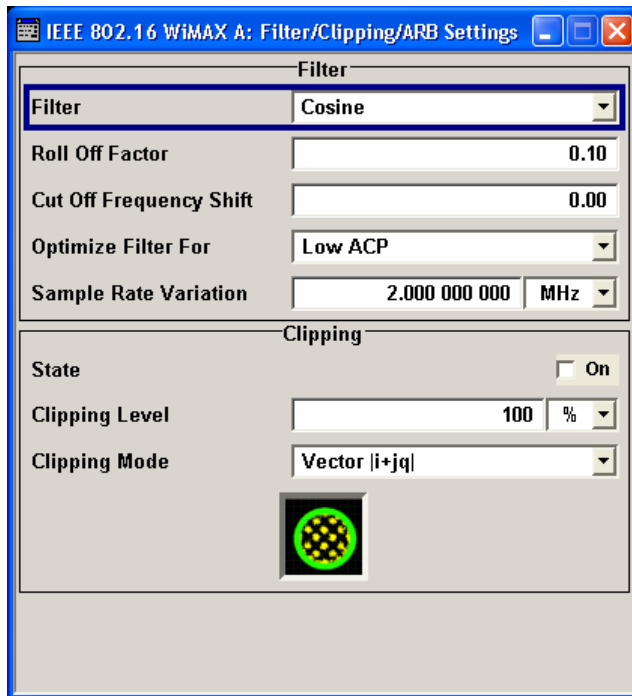

### Filter - WiMAX

Indicates the baseband filter.

Remote-control command: `SOUR:BB:WIM:FILT:TYPE?`

### Roll Off Factor - WiMAX

Indicates the filter parameter.

For the default cosine filter a roll off factor of 0.07 is used.

Remote-control command:

```
SOUR:BB:WIM:FILT:PAR:COS 0.05
SOUR:BB:WIM::FILT:PAR:RCO 0.05
SOUR:BB:WIM::FILT:PAR:PGA 0.15
SOUR:BB:WIM::FILT:PAR:GAU 0.15
SOUR:BB:WIM::FILT:PAR:SPH 0.15
SOUR:BB:WIM::FILT:PAR:APCO25 0.05
```

**Cut Off Frequency Shift - WiMAX**

**(This feature is available for filter parameter Cosine only.)**

Sets the value for the cut off frequency shift. The cut off frequency of the cosine filter can be adjusted to reach spectrum mask requirements.

The value range is -1.0 to 1.0.

Remote-control command:

```
SOUR:BB:WIM:FILT:PAR:COS:COFS 1.0
```

**Optimize Filter For - WiMAX**

The setting Low ACP gives best ACP and EVM performance. The setting Low EVM is only needed for debugging purposes.

The value range is -1.0 to 1.0.

Remote-control command:

```
SOUR:BB:WIM:FILT:OPT:LEV M
```

**Sample Rate Variation - WiMAX**

Sets the sample rate of the signal.

A variation of this parameter only affects the ARB clock rate, all other signal parameters remain unchanged. If the sampling rate in the frame configuration menu is changed, this parameter is reset to the chosen sampling rate.

Remote-control command:

```
SOUR:BB:WIM:SRAT:VAR 40000000
```

The settings for clipping are collected in the **Clipping** section.

**Clipping State - WiMAX**

Switches baseband clipping on and off.

Baseband clipping is a very simple and effective way of reducing the crest factor of the WiMAX signal.

With baseband clipping, the signal level is limited to a settable value (Clipping Level). This level is specified as a percentage of the highest peak value. Since clipping is done prior to filtering, the procedure does not influence the spectrum. The EVM however increases.

Remote-control command:

```
SOUR:BB:WIM:CLIP:STAT ON
```

**Clipping Level- WiMAX**

Sets the limit for clipping.

This value indicates at what point the signal is clipped. It is specified as a percentage, relative to the highest level. 100% indicates that clipping does not take place.

Remote-control command:

```
SOUR:BB:WIM:CLIP:LEV 50
```

**Clipping Mode - WiMAX**

Selects the clipping method. A graphic illustration of the way in which these two methods work is given in the menu.

**Vector  $|i + q|$** 

The limit is related to the amplitude  $|i + q|$ . The I and Q components are mapped together, the angle is retained (see also Clipping State).

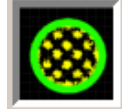

Remote-control command:

SOUR:BB:WIM:CLIP:MODE VECT

**Scalar  $|i| + |q|$** 

The limit is related to the absolute maximum of all the I and Q values  $|i| + |q|$ .

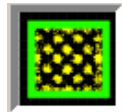

The I and Q components are mapped separately, the angle changes.

Remote-control command:

SOUR:BB:WIM:CLIP:MODE SCAL



# Trigger/Marker/Clock - WiMAX

The **Trigger/Marker/Clock** menu can be reached via the IEEE 802.16 WiMAX main menu.

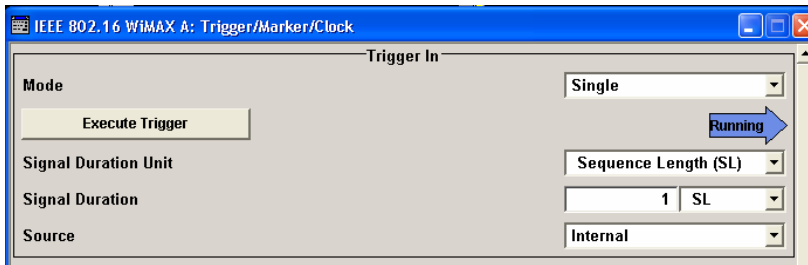

The **Trigger In** section is where the trigger for the IEEE 802.16 WiMAX signal is set. Various parameters will be provided for the settings, depending on which trigger source - internal or external - is selected. The current status of signal generation (**Running** or **Stopped**) is indicated for all trigger modes.

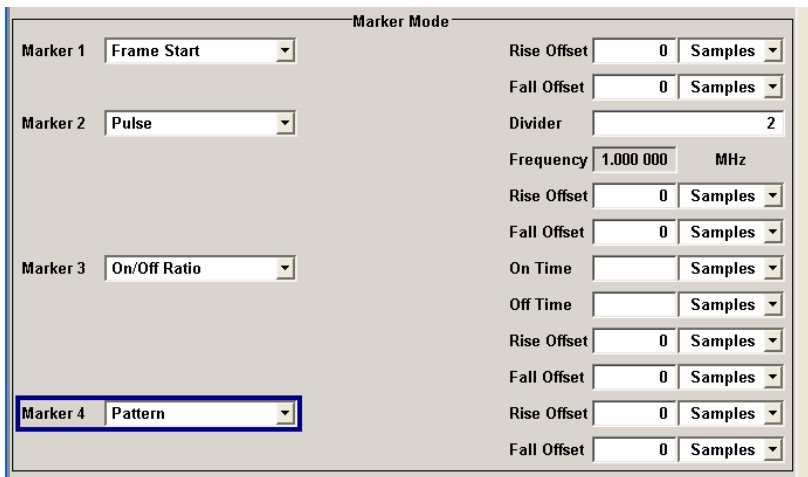

The **Marker Mode** section is where the marker signals at the MARKER output connectors are configured.

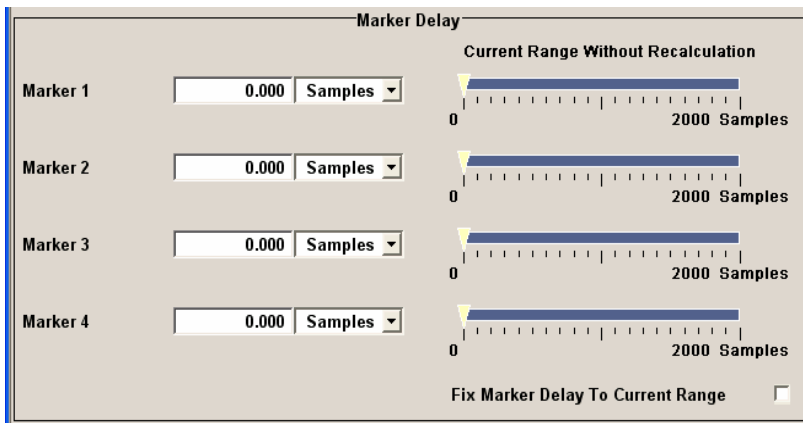

The **Marker Delay** section is where a marker signal delay can be defined, either without restriction or restricted to the dynamic section, i.e., the section in which it is possible to make settings without restarting signal and marker generation.

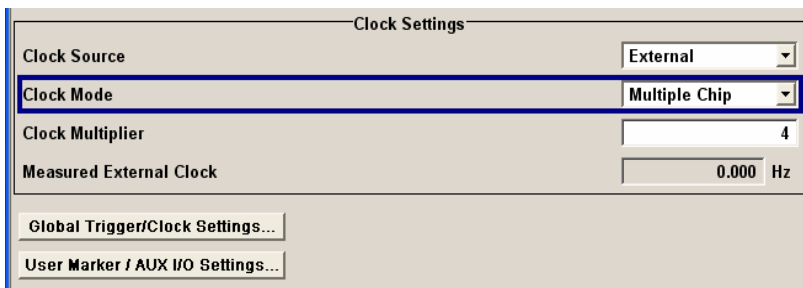

The **Clock Settings** section is where the clock source is selected and - in the case of an external source - the clock type. The **Global Trigger/Clock Settings** button leads to a submenu for general trigger and clock settings. The **User marker / AUX I/O Settings** button leads to a submenu for mapping the AUX I/O connector on the rear of the instrument

The **Trigger In** section is where the trigger for the IEEE 802.16 WiMAX signal is set. The current status of the signal generation is displayed for all trigger modes.

<b>Trigger Mode - WiMAX</b>	<p>Selects trigger mode.</p> <p>The trigger mode determines the effect of a trigger on the signal generation.</p>
<b>Auto</b>	<p>The IEEE 802.16 WiMAX signal is generated continuously.</p> <p>Remote-control command: SOUR:BB:WIM:SEQ AUTO</p>
<b>Retrigger</b>	<p>The IEEE 802.16 WiMAX signal is generated continuously. A trigger event (internal or external) causes a restart.</p> <p>Remote-control command: SOUR:BB:WIM:SEQ RETR</p>
<b>Armed_Auto</b>	<p>The IEEE 802.16 WiMAX-Signal signal is generated only when a trigger event occurs. Then the signal is generated continuously.</p> <p>Button <b>Arm</b> stops signal generation. A subsequent trigger event (internal with <b>Execute Trigger</b> or external) causes a restart.</p> <p>Remote-control command: SOUR:BB:WIM:SEQ AAUT</p>
<b>Armed_Retrigger</b>	<p>The IEEE 802.16 WiMAX-Signal signal is generated only when a trigger event occurs. Then the signal is generated continuously. Every subsequent trigger event causes a restart.</p> <p>Button <b>Arm</b> stops signal generation. A subsequent trigger event (internal with <b>Execute Trigger</b> or external) causes a restart.</p> <p>Remote-control command: SOUR:BB:WIM:SEQ ARET</p>
<b>Single</b>	<p>The IEEE 802.16 WiMAX signal is generated only when a trigger event occurs. Then the signal is generated once to the length specified at <b>Signal Duration</b>. Every subsequent trigger event (internal with <b>Execute Trigger</b> or external) causes a restart.</p> <p>Remote-control command: SOUR:BB:WIM:SEQ SING</p>

**Signal Duration - WiMAX** Defines the length of the signal sequence to be output in the **Single** trigger mode. The input is to be expressed in samples. It is then possible to output deliberately just part of the signal, an exact sequence of the signal, or a defined number of repetitions of the signal.

Remote-control commands:

SOUR:BB:WIM:TRIG:SLEN 2000

**Signal Duration Unit - WiMAX**

Defines the unit for the entry of the length of the signal sequence to be output in the **Single** trigger mode. Available units are frame, chip or sequence length (SL).

Remote-control command:

SOUR:BB:WIM:TRIG:SLUN FRAM

**Running - Stopped - WiMAX**

Displays the status of signal generation for all trigger modes. This display appears only when IEEE 802.16 WiMAX is enabled (**State On**).

Remote-control command:

SOUR:BB:WIM:TRIG:RMOD?

Response: RUN or STOP

**Running**

The IEEE 802.16 WiMAX modulation signal is generated; a trigger was (internally or externally) initiated in triggered mode.

If Armed\_Auto and Armed\_Retrigger have been selected, generation of signals can be stopped with the Arm button. A new trigger (internally with Execute Trigger or externally) causes a restart.

**Stopped**

The signal is not generated, and the instrument waits for a trigger event (internal or external).

**Arm - WiMAX**

Stops signal generation. This button appears only with **Running** signal generation in the **Armed\_Auto** and **Armed\_Retrigger** trigger modes.

Signal generation can be restarted by a new trigger (internally with **Execute Trigger** or externally).

Remote-control command:

SOUR:BB:WIM:TRIG:ARM:EXEC

**Execute Trigger - WiMAX**

Executes trigger manually. A manual trigger can be executed only when an internal trigger source and a trigger mode other than Auto have been selected.

Remote-control commands:

SOUR:BB:WIM:TRIG:SOUR INT

SOUR:BB:WIM:SEQ RETR

SOUR:BB:WIM:TRIG:EXEC

**Trigger Source - WiMAX**

Selects trigger source. This setting is effective only when a trigger mode other than Auto has been selected.

**Internal**

The trigger event is executed by **Execute Trigger**.

Remote-control command:

```
SOUR:BB:WIM:TRIG:SOUR INT
```

**Internal (Baseband A/B)**

The trigger event is executed by the trigger signal from the second path (two-path instruments only).

Remote-control command:

```
SOUR:BB:WIM:TRIG:SOUR OBAS
```

**External TRIGGER 1 / 2)**

The trigger event is executed with the aid of the active edge of an external trigger signal. The trigger signal is supplied via the TRIGGER 1 or TRIGGER 2 connector.

The polarity, the trigger threshold and the input impedance of the TRIGGER input can be set in the **Global Trigger/Clock Settings** menu.

Remote-control command:

```
SOUR:BB:WIM:TRIG:SOUR EXT | BEXT
```

**External / Trigger Delay - WiMAX**

Sets trigger signal delay in samples on external triggering or on internal triggering via the second path.

This enables the R&S Vector Signal Generator to be synchronized with the device under test or other external devices.

**Note**

*The delay can be set separately for each of the two paths.*

Remote-control command:

```
SOUR:BB:WIM:TRIG:EXT:DEL 3
```

```
SOUR:BB:WIM:TRIG:OBAS:DEL 3
```

**External / Trigger Inhibit - WiMAX**

Sets the duration for inhibiting a new trigger event subsequent to triggering. The input is to be expressed in samples.

In the **Retrigger** mode every trigger signal causes signal generation to restart. This restart is inhibited for the specified number of samples.

This parameter is only available on external triggering or on internal triggering via the second path.

**Note:**

*The trigger inhibit can be set separately for each of the two paths.*

Remote-control command:

```
SOUR:BB:WIM:TRIG:EXT:INH 1000
```

```
SOUR:BB:WIM:TRIG:OBAS:INH 1000
```

The marker output signal for synchronizing external instruments is configured in the **Marker Settings** section **Marker Mode**.

**Marker Mode - WiMAX**

Selects a marker signal for the associated MARKER output.



**Restart** A marker signal is generated at the start of each ARB sequence.

Remote-control command:  
`SOUR:BB:WIM:TRIG:OUTP1:MODE REST`

**Frame Start** A marker signal is generated at the start of each frame.

Remote-control command:  
`SOUR:BB:WIM:TRIG:OUTP1:MODE FRAM`

**Frame Active Part** The marker signal is high whenever a burst is active and low during inactive signal parts (such as the gaps between bursts in uplink mode or the uplink subframe in downlink TDD mode).

This marker can be used to decrease the carrier leakage during inactive signal parts by feeding it into the pulse modulator.

Remote-control command:  
`SOUR:BB:WIM:TRIG:OUTP1:MODE FACT`

**Pulse** A regular marker signal is generated. The clock frequency is defined by entering a divider. The frequency is derived by dividing the sample rate by the divider. The input box for the divider opens when **Pulse** is selected, and the resulting pulse frequency is displayed below it.

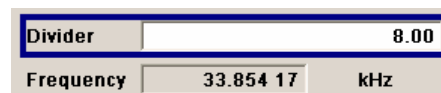

Remote-control commands:  
`SOUR:BB:WIM:TRIG:OUTP1:MODE PULS`  
`SOUR:BB:WIM:TRIG:OUTP1:PULS:DIV 4`  
`SOUR:BB:WIM:TRIG:OUTP1:PULS:FREQ?`

**Pattern**

A marker signal that is defined by a bit pattern is generated. The pattern has a maximum length of 32 bits and is defined in an input field which opens when **pattern** is selected.



Remote-control commands:

```
SOUR:BB:WIM:TRIG:OUTP1:MODE PATT
SOUR:BB:WIM:TRIG:OUTP1:PATT #B1111,4
```

**ON/OFF ratio**

A regular marker signal that is defined by an ON/OFF ratio is generated. A period lasts one ON and OFF cycle.

Start of signal

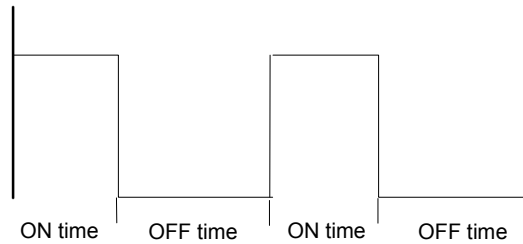

The ON time and OFF time are each expressed as a number of symbols and are set in an input field which opens when **ON/OFF ratio** is selected.



Remote-control commands:

```
SOUR:BB:WIM:TRIG:OUTP1:MODE RAT
SOUR:BB:WIM:TRIG:OUTP1:OFFT 20
SOUR:BB:WIM:TRIG:OUTP1:ONT 20
```

**Rise Offset - WiMAX**

Sets the value for the rise offset. The rising ramp of the marker is shifted by the set value in samples. Positive values shift the rising ramp to later positions, negative values shift it to earlier positions.

The value range is -64000 to 64000.

Remote-control command:

```
SOUR:BB:WIM:TRIG:OUTP2:ROFF 5000
```

**Fall Offset - WiMAX**

Sets the value for the fall offset. The falling ramp of the marker is shifted by the set value in samples. Positive values shift the falling ramp to later positions, negative values shift it to earlier positions.

The value range is -64000 to 64000.

Remote-control command:

```
SOUR:BB:WIM:TRIG:OUTP2:FOFF 5000
```

The **Marker Delay** section can be used to set a delay for the markers.

**Marker x Delay - WiMAX**

Enters the delay between the marker signal at the marker outputs and the start of the signal.

The input is expressed as a number of samples.

If the setting "**Fix marker delay to dynamic range**" is enabled, the setting range is restricted to the dynamic range. In this range the delay of the marker signals can be set without restarting the marker and signal.

The allocation of marker signals to the outputs is described in the section "[Marker Output Signals](#)".

Remote-control command:

```
SOUR:BB:WIM:TRIG:OUTP2:DEL 20
```

**Current Range without Calculation - WiMAX**

Displays the dynamic range within which the delay of the marker signals can be set without restarting the marker and signal.

The delay can be defined by moving the setting mark.

Remote-control command:

```
SOUR:BB:WIM:TRIG:OUTP2:DEL:MAX?
```

```
SOUR:BB:WIM:TRIG:OUTP2:DEL:MIN?
```

**Fix marker delay to current range - WiMAX**

Restricts the marker delay setting range to the dynamic range. In this range the delay can be set without restarting the marker and signal.

Remote-control command:

```
SOUR:BB:WIM:TRIG:OUTP:DEL:FIX ON
```

The clock source is selected in the **Clock Settings** section.

**Clock Source - WiMAX**

Selects the clock source (also see section "[Clock Signals](#)").

**Intern**

The internal clock reference is used to generate the sample clock.

Remote-control command:

SOUR:BB:WIM:CLOC:SOUR INT

**Clock Mode - WiMAX**

Enters the type of externally supplied clock.

**Sample**

A sample clock is supplied via the CLOCK connector.

Remote-control command:

SOUR:BB:WIM:CLOC:MODE SAMP

**Multiple Sample**

A multiple of the sample clock is supplied via the CLOCK connector; the sample clock is derived internally from this.

The **Multiplier** window provided allows the multiplication factor to be entered.

Remote-control command:

SOUR:WIM:CLOC:MODE MSAM

**Sample Clock Multiplier - WiMAX**

Enters the multiplication factor for clock type **Multiple Sample**.

Remote-control command:

SOUR:BB:WIM:CLOC:MULT 4

**Measured External Clock - WiMAX**

Displays the measured frequency of the external clock signal. This enables the user to permanently monitor the frequency of the externally introduced clock.

This information is displayed only if the external clock source has been selected.

Remote-control command:

:CLOC:INP:FREQ?



**Global Trigger/Clock Settings - WiMAX**

Calls the **Global Trigger/Clock/Input Settings** menu. This menu is used among other things for setting the trigger threshold, the input impedance and the polarity of the clock and trigger inputs

In the case of two-path instruments these settings are valid for both paths.

The parameters in this menu affect all digital modulations and standards, and are described in the section "[Global Trigger/Clock/Input Settings – Setup -Environment](#)".

**User Marker / AUX I/O Settings - WiMAX**

Calls the **User Marker AUX I/O Settings** menu. This menu is used to map the connector on the rear of the instruments see section "[User Marker - AUX IO - Setup-Environment-Global...Settings](#)".

# Digital Standard GPS

## Introduction - Digital Standard GPS

The R&S Vector Signal Generator provides you with the ability to generate signals of up to four Global Positioning System (GPS) satellites.

The equipment layout for GPS signal generation includes the options Baseband Main Module (B13), Baseband Generator (B10/B11) and Digital Standard GPS (K44). B10 features a much larger ARB memory size than B11 (see data sheet). But apart from the memory size, both options have the same functionality and are installed alternatively.

In the case of two-path instruments, at least one more option, the Baseband Generator (B10/B11) is required to generate a GPS signal in the second path. With this option, a GPS signal can be defined on path B and then either be routed to path A or added to the path A signal with a settable frequency offset. Generating the GPS signal simultaneously on paths A and B requires an additional, second option Digital Standard GPS (K44). With a full path B configuration with a second option Baseband Main Module (B13) and an RF section (frequency option B20x), the GPS signal can be output at RF output B.

The Global Positioning System consists of several satellites circling the earth in low orbits. The satellites permanently transmit information about their current position (ephemeris) and about the orbits of all satellites (almanac). An additionally transmitted time information enables the GPS receiver to determine the runtimes of the transmitted signals. The position of a receiver on the earth can be determined by carrying out delay measurements of at least four signals emitted by different satellites.

Being transmitted on a single carrier frequency, the signals of the individual satellites can be distinguished by means of correlation (Gold) codes. With GPS, the code is known as C/A code ( $f_{ca} = 1.023$  MHz) for civilian purposes. It is used as spreading code for the navigation data which is transmitted at a rate of 50 baud. The carrier L1 ( $f_{L1} = 1.57542$  GHz) is modulated by C/A-code (BPSK).

---

### Note:

*To avoid any damage to connected receivers, the user must ensure that the signal level used is not too high. A downstream attenuator pad must be connected to generate output levels below -145 dBm.*

---

A GPS signal which allows receiver function tests to be carried out, can be generated by the vector signal generator for up to four satellites per baseband path.

Table 4-30 GPS system parameters

Carrier frequency	1.57542 GHz
Signal level, after antenna	Approx. -115 dBm, depending on receive conditions
Doppler shift	-100 kHz to +100 kHz selectable
Symbol rate (C/A code)	1.023 Mcps
C/A codes	1 to 37 selectable, 1023 chips per C/A code
Modulation	BPSK
Information data rate (navigation data)	50 Hz
Frame structure of navigation data	25 frames consisting of 5 subframes where 1 subframe consists of 10 words, 1 word consists of 30 data bits, 1 data bit consists of 20460 C/A code chips.

### Use of navigation data

The C/A code used is fundamental to the simulation of GPS signals. The C/A code specifies the satellites to be simulated. Real navigation data (the almanac) contains the information about the currently valid ids. When using real navigation data, only valid ids can be selected in the operating menu. When using arbitrary data, the complete range of ids, 1 to 37, is available.

In addition to this, navigation data play an extremely important role, since they are essential for calculating the positions of the four satellites, which are the minimum prerequisite for localization purposes. However, even if only one satellite is available, real navigation data can be used to check the decoding of navigation information (such as GPS time, almanac and ephemeris) in addition to the recognition of the C/A code.

Current almanac data can be downloaded via the Internet and stored on the harddisk of the Vector Signal Generator. The almanac data is also used for extracting the satellite-specific navigation information (ephemeris).

For more detailed information on the content and frame structure of navigation data, as well as C/A code generation, refer to the specifications.

## GPS Menu

The menu for setting the GPS digital standard is either called from the baseband block or from the menu tree under Baseband.

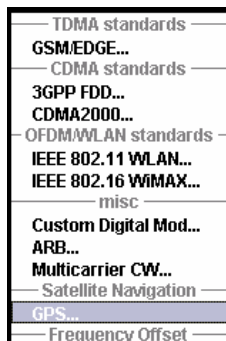

The menu is split into several sections for configuring the standard.

The upper section of the menu is where the GPS digital standard is enabled and the default settings are called.

Buttons lead to the submenus for loading and saving the GPS configuration and for configuring the trigger and clock parameters.

The **Navigation Data** menu section is where the data source for navigation information is selected and the data indicated (in case of real navigation data).

The button in the lower section leads to the submenu for configuring the satellite signals.

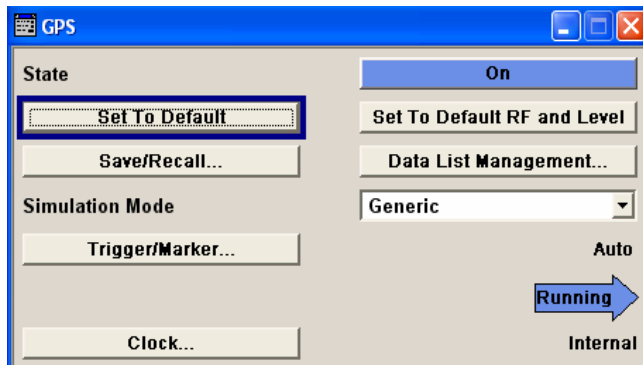

The upper section of the menu is where the GPS digital standard is enabled and the default settings are called and the simulation mode is selected.

Buttons lead to the submenus for loading and saving the GPS configuration and for configuring the trigger and clock parameters.

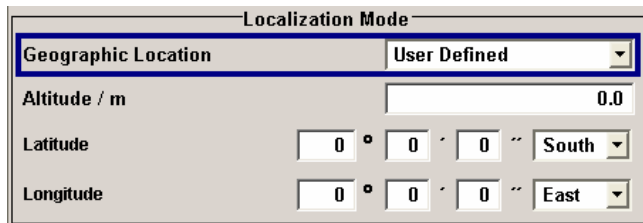

The **Localization Mode** menu section is where the satellite signals are configured corresponding to a 'real' location which can be selected by the user.

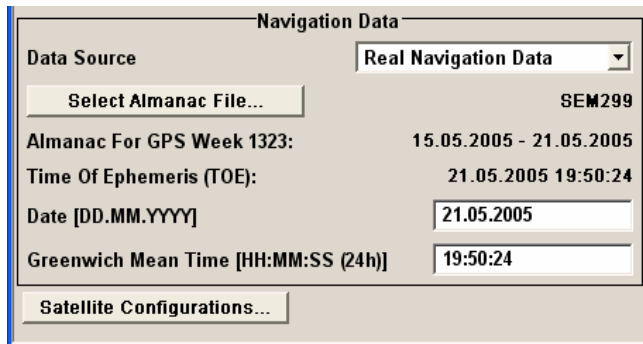

The **Navigation Data** menu section is where the data source for navigation information is selected and the data indicated (in case of real navigation data).

The button in the lower section leads to the submenu for configuring the satellite signals.

## General Settings for GPS Simulation

The upper section of the menu is where the GPS digital standard is enabled, the default settings are called. Buttons lead to the submenus for loading and saving the GPS configuration and for configuring the trigger and clock parameters.

### State - GPS

Enables/disables the GPS signal simulation.

Enabling this standard disables all the other digital standards and digital modulation modes on the same path.

A continuous GPS signal is generated for up to four satellite in real time mode.

The associated signal level is set in the RF level menu.

Remote-control command:

```
SOUR:BB:GPS:STAT ON
```

**Set to default - GPS**

Calls the default settings. The following table gives an overview of the settings. The preset value for each parameter is specified in the description of the remote-control commands.

**Note:**

*RF and level are preset with button **Set to default RF and Level**.*

Remote-control command:

SOUR:BB:GPS:PRES

Parameter	Value
State	Not affected by Set to default
Simulation Mode	Generic
Navigation Data Source	Real navigation data
Almanac	SEM299
Date	Date of TOE
Time	Time of TOE
Satellite configuration	
State satellite 1	On
State satellite 2 ... 4	Off
Space Vehicle Id (satellite 1 ... 4)	1 / 2 / 3 / 4
Ranging Code	C/A
Time Shift / P-code-Chips	0
Doppler Shift	0 Hz

**Set to default RF and Level - GPS**

Calls the default RF and level settings for GPS signals.

The frequency is set to the GPS carrier frequency L1 of 1.57542 GHz and the output level LEVEL is set to -115.0 dBm.

**Note:**

*To avoid any damage to connected receivers, the user must ensure that the signal level used is not too high. A downstream attenuator pad must be connected to generate output levels below -145 dBm.*

Remote-control command:

SOUR:BB:GPS:PRFL

**Save/Recall - GPS**

Calls the **Save/Recall** menu.

From the **Save/Recall** menu the **File Select** windows for saving and recalling GPS configurations and the **File Manager** can be called.



GPS configurations are stored as files with the predefined file extension **\*.gps**. The file name and the directory they are stored in are user-definable.

The complete settings in the **GPS** menu are saved and recalled.

**Recall GPS setting**

Opens the **File Select** window for loading a saved GPS configuration.

The configuration of the selected (highlighted) file is loaded by pressing the **Select** button.

Remote-control command:

```
MMEM:CDIR 'F:\gen_lists\gps'
```

```
SOUR:BB:GPS:SETT:CAT?
```

```
Response: 'gps_1',gps_2'
```

```
SOUR:BB:GPS:SETT:LOAD "gps_1"
```

**Save GPS setting**

Opens the **File Select** window for saving the current GPS signal configuration.

The name of the file is specified in the **File name** entry field, the directory selected in the **Save into** entry field. The file is saved by pressing the **Save** button.

Remote-control command:

```
MMEM:CDIR 'F:\gen_lists\gps'
```

```
SOUR:BB:GPS:SETT:STOR 'gps_3'
```

**File Manager**

Calls the **File Manager**.

The **File Manager** is used to copy, delete and rename files and to create new directories.

Remote-control commands:

```
MMEM:CDIR 'F:\gen_lists\gps'
```

```
SOUR:BB:GPS:SETT:DEL 'gps_1'
```

**Data List Management - GPS**

Calls the **Data List Management** menu. This menu is used to create and edit a data list.

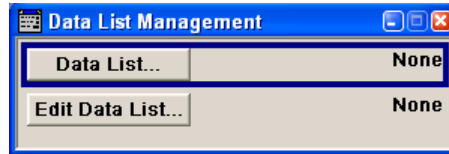

All data lists are stored as files with the predefined file extension **\*.dm\_iqd**. The file name and the directory they are stored in are user-definable.

The data lists must be selected as a data source from the submenus under the individual function, e.g. in the channel table of the base stations.

Remote-control commands:

**Note:**

*All data lists are generated and edited by means of the SOURce:BB:DM subsystem commands. Files containing data lists usually end with \*.dm\_iqd. The data lists are selected as a data source for a specific function in the individual subsystems of the digital standard.*

**Creating and editing the data list:**

```
SOUR:BB:DM:DLIS:SEL "3gpp"
SOUR:BB:DM:DLIS:DATA 1,1,0,1,0,1,0,1,1,1,1,0,0,0
SOUR:BB:DM:DLIS:DATA:APP 1,1,0,1,0,1,0,1,1,1,1,0,0
```

**Selecting the data list:**

```
SOUR:BB:GPS:DATA DLIS
SOUR:BB:GPS:DATA:DLISt "gps_data"
```

**Simulation Mode - GPS**

Sets the simulation mode.

The settings of the satellite signals are provided in the submenu **Satellite Configuration** (see following section).

**Generic**

The satellite signals are configured by the user.

Remote-control command:

```
SOUR:BB:GPS:SMOD GEN
```

**Localization**

The satellite signals are configured corresponding to a 'real' location which can be selected by the user.

Remote-control command:

```
SOUR:BB:GPS:SMOD LOC
```

**Trigger - Marker - GPS** Calls the menu for selecting the trigger source, for configuring the marker signals and for setting the time delay of an external trigger signal (see Section "[Trigger/Marker/Clock - 3GPP FDD](#)", Page 4.732).  
The currently selected trigger source is displayed to the right of the button. The marker signal is always related to the first active satellite.

Remote-control command: n.a.

**Execute Trigger - GPS** **(This feature is only available for Trigger Source Internal.)**  
Executes trigger manually.  
A manual trigger can be executed only when an internal trigger source and a trigger mode other than **Auto** have been selected.

Remote-control commands:

```
SOUR:BB:GPS:TRIG:SOUR INT
```

```
SOUR:BB:GPS:SEQ RETR
```

```
SOUR:BB:GPS:TRIG:EXEC
```

**Clock - GPS** Calls the menu for selecting the clock source and for setting a delay (see Section "[Trigger/Marker/Clock - 3GPP FDD](#)", Page 4.732").

Remote-control command: n.a.

The **Localization Mode** menu section is where the satellite signals are configured corresponding to a 'real' location which can be selected by the user.

**Geographic Location - GPS** Selects the geographic location.

Remote-control commands:

```
SOUR:BB:GPS:LOC "Munich"
```

**Altitude - GPS** Sets the geographic altitude.

This field is only available for user defined geographic locations. If a value other than **User Defined** is selected in the **Geographic Location** field, the **Altitude** field is read only.

Remote-control commands:

```
SOUR:BB:GPS:LOC ALT 500
```



**Latitude - GPS**

Sets the latitude of the user defined geographic location.

This field is only available for user defined geographic locations. If a value other than **User Defined** is selected in the **Geographic Location** field, the **Latitude** field is read only.

Remote-control commands:

```
SOUR:BB:GPS:LOC:LAT:DEGR 48
SOUR:BB:GPS:LOC:LAT:MIN 9
SOUR:BB:GPS:LOC:LAT:SEC 0
SOUR:BB:GPS:LOC:LAT:DIR NORT
```

**Longitude - GPS**

Sets the longitude of the user defined geographic location.

This field is only available for user defined geographic locations. If a value other than **User Defined** is selected in the **Geographic Location** field, the **Longitude** field is read only.

Remote-control commands:

```
SOUR:BB:GPS:LOC:LONG:DEGR 11
SOUR:BB:GPS:LOC:LONG:MIN 35
SOUR:BB:GPS:LOC:LONG:SEC 0
SOUR:BB:GPS:LOC:LONG:DIR EAST
```

The **Navigation Data** menu section is where the data source for navigation information is selected and the data indicated (in case of real navigation data).

**Navigation Data Source - GPS**

Selects data source for the navigation information. Navigation data play an extremely important role, since they are essential for calculating the positions of the four satellites, which are the minimum prerequisite for localization purposes. It also contains the information about the currently valid ids for the satellites.

---

**Note:**

*If **Localization** is selected as simulation mode, **Real Navigation Data** is preselected and no other data source can be selected.*

---

**Real Navigation Data** **Real Navigation Data** (almanacs) can be downloaded from the internet and stored on the harddisk of the generator.

---

**Note:**

*Supported almanac files are SEM-files with data extension \*.txt. YUMA almanac files are not supported.*

---

The almanac file to be used is selected in the file manager which is called with button **Select Almanac File...** The time information of the file is indicated below the button. The simulated date and time can be set within the time interval determined by the loaded almanac (GPS week).

The satellite specific information (ephemeris) is also taken from the almanac. The time of ephemeris is indicated.

All indications and entries are made in Greenwich Mean Time.

**Remote-control commands**

```
SOUR:BB:GPS:NAV:DATA RND
SOUR:BB:GPS:NAV:ALM "sem299"
```

**PRBSxx  
Data List  
Pattern**

Arbitrary data can be used for basic tests on the GPS signals. Data sources **PN9**, **PN15**, **PN16**, **PN20**, **PN21**, **PN23**, **ALL 0**, **ALL1**, and **Pattern** are all available.

If the **Pattern** data type is used, the bit pattern is defined in the **Pattern** input box. The length is limited to 64 bits.

**Data lists** are selected in the **File Select** window, which is called by means of the **Data List Management** button.

Signals generated in this way can be recognized by a GPS receiver. However, since there are no real navigation data on the C/A code, only the signal level of the simulated satellite(s) can be measured and displayed by the receiver.

A signal of this type is usually sufficient for performing simple function tests. It should be noted, however, that the receiver to be tested may have to be switched to a special test mode, since signals without correct navigation data are often not indicated (on a display, for example).

**Remote-control**

```
commandsSOUR:BB:GPS:NAV:DATA ZERO
SOUR:BB:GPS:NAV:DATA PN9
SOUR:BB:GPS:NAV:DATA PATT
SOUR:BB:GPS:NAV:DATA:PATT #H3F,8
SOUR:BB:GPS:NAV:DATA DLIS
SOUR:BB:GPS:NAV:DATA:DSEL "gps_1"
```

**Select Almanac File - GPS** Opens the file manager for selecting the almanac file.

The button is only available if data source **Real Navigation Data** is selected.

The downloaded files can be copied to the vector signal generator via USB interface or via a LAN network (see chapter 1).

Current almanacs are currently available at the following internet sites:

U.S.Coast Guard Navigation Center GPS Homepage  
(<http://www.navcen.uscg.gov/ftp/GPS/almanacs/sem/>)

The almanac file are named semxxxx.txt whereas xxxx denotes the GPS week.

<http://www.celestrak.com/GPS/almanac/SEM/>

The almanac file are named almanac.sem.weekXXXX.YYYYYY.txt whereas xxxx denotes the GPS week and yyyyyy the time of almanac (TOA).

---

**Note:**  
*Supported almanac files are SEM-files with data extension \*.txt.  
YUMA almanac files are not supported.*

---

Remote-control commands:  
SOUR:BB:GPS:NAV:DATA:SOUR RND  
SOUR:BB:GPS:NAV:ALM "sem299"

**Almanac For GPS Week - GPS** Indicates the week in which the almanac was published. The simulation time (**Date**) can be set within this time interval.

The indication is only available if data source **Real Navigation Data** is selected.

Remote-control commands:  
SOUR:BB:GPS:NAV:ALM:BEG:WNUM?  
SOUR:BB:GPS:NAV:ALM:BEG:DAY?  
SOUR:BB:GPS:NAV:ALM:BEG:MONT?  
SOUR:BB:GPS:NAV:ALM:BEG:YEAR?  
SOUR:BB:GPS:NAV:ALM:END:DAY?  
SOUR:BB:GPS:NAV:ALM:END:MONT?  
SOUR:BB:GPS:NAV:ALM:END:YEAR?

**Time Of Ephemeris - GPS** Indicates the time of ephemeris, i.e the exact time up to the second to which the navigation data refers. As the ephemeris is extracted from the almanac, the TOE is identical to the TOA (time of almanac).

The indication is only available if data source **Real Navigation Data** is selected.

Remote-control commands:  
SOUR:BB:GPS:NAV:ALM:TOEP?  
Response: "589824"

**Date - GPS**

Enters the date for the simulation. Only values within the almanac GPS week are valid.

The parameter is only available if data source **Real Navigation Data** is selected.

Remote-control commands:

SOUR:BB:GPS:NAV:SIM:BEG:DAY 12

SOUR:BB:GPS:NAV:SIM:BEG:MONT 7

SOUR:BB:GPS:NAV:SIM:BEG:YEAR 2005

**Greenwich Mean Time - GPS**

Enters the exact time for the simulation. The used time zone is Greenwich Mean Time.

The parameter is only available if data source **Real Navigation Data** is selected.

Remote-control commands:

SOUR:BB:GPS:NAV:SIM:BEG:SEC 14

SOUR:BB:GPS:NAV:SIM:BEG:MIN 24

SOUR:BB:GPS:NAV:SIM:BEG:HOURL 0

**Satellite Configuration - GPS**

Calls the menu for configuring the satellite data (see following section).

Remote-control command: n.a.

## Satellite Configuration - GPS

In the Satellite Configuration submenu the signal simulation of up to four satellites can be activated and configured.

	Satellite 1	Satellite 2	Satellite 3	Satellite 4
State	On	On	On	On
Space Vehicle ID	5	29	2	9
Ranging Code	C/A	C/A	C/A	C/A
Time Shift / CA-Chips/40	1 156 907.234	1 189 124.843	1 308 090.688	1 274 475.057
Time Shift / ms	28.272	29.060	31.967	31.146
Power / dB	-6.02	-6.02	-6.02	-6.02
Doppler Shift	2.429 19 kHz	1.100 19 kHz	-1.377 78 kHz	1.483 48 kHz
Resulting Frequency / GHz	1.575 422 429 19	1.575 421 100 19	1.575 418 622 22	1.575 421 483 48
Resulting C/A Chip Rate / MHz	1.023 001 58	1.023 000 71	1.022 999 11	1.023 000 96
Resulting P Chip Rate / MHz	10.230 015 77	10.230 007 14	10.229 991 05	10.230 009 63

**Adjust Total Power to 0dB - GPS** Sets the power level of each satellite so that the sum of all levels results in 0 dB. This will not change the power ratio among the individual satellites.

Remote-control command:  
 SOUR:BB:GPS:POW:ADJ

### Total Power - GPS

Displays the total power of all satellites.

The total power is calculated from the power ratio of the activated satellites.

After **Power Adjust**, this power corresponds to 0 dB.

If the value is not equal to 0 dB, the individual activated satellites (whilst still retaining the power ratios) are internally adapted so that the **Total Power** for achieving the set output level is 0 dB.

Remote-control command:  
 SOUR:BB:GPS:POW?  
 'Response: 0dB

<b>Use Spreading - GPS</b>	<p>Activates/deactivates spreading. When spreading is deactivated the pure navigation data is modulated onto the RF carrier.</p> <p>Remote-control command:  SOUR:BB:GPS:SPR:STAT ON</p>						
<b>Satellite State - GPS</b>	<p>Activates/deactivates the generation of the satellite signal.</p> <p>Remote-control command:  SOUR:BB:GPS:SAT4:STAT ON</p>						
<b>Space Vehicle Id - GPS</b>	<p>Enters the id of the satellite to be simulated. This value is used to generate the corresponding C/A code.</p> <p>37 ids are defined whereas 32 codes are used for identifying satellites.</p> <p>If <b>Real Navigation Data</b> is used, only the valid ids which are listed in the almanac are selectable.</p> <p>For arbitray data, all ids can be selected.</p> <p>Remote-control command:  SOUR:BB:GPS:SAT4:VID 24</p>						
<b>Ranging Code - GPS</b>	<p>Indicates the type of ranging code.</p> <p>The C/A code (<math>f_{ca} = 1.023</math> MHz) is provided for civilian purposes. The P-code (<math>f_p = 10.23</math> MHz) is provided for military purposes. They are used as spreading codes for the navigation data which is transmitted at a rate of 50 baud.</p> <table border="0" style="margin-top: 20px;"> <tr> <td style="vertical-align: top;"><b>C/A</b></td> <td> <p>Carrier L1 (<math>f_{L1} = 1.57542</math> GHz) is modulated by C/A-code (BPSK).</p> <p>Remote-control command:  SOUR:BB:GPS:SAT4:RCOD?  Response: CAC</p> </td> </tr> <tr> <td style="vertical-align: top;"><b>C/A + P</b></td> <td> <p>Not available yet.</p> <p>Carrier L1 (<math>f_{L1} = 1.57542</math> GHz) is modulated by C/A code and P-code (QPSK).</p> </td> </tr> <tr> <td style="vertical-align: top;"><b>P</b></td> <td> <p>Not available yet.</p> <p>Carrier L1 (<math>f_{L1} = 1.57542</math> GHz) is modulated by P-code (BPSK).</p> </td> </tr> </table>	<b>C/A</b>	<p>Carrier L1 (<math>f_{L1} = 1.57542</math> GHz) is modulated by C/A-code (BPSK).</p> <p>Remote-control command:  SOUR:BB:GPS:SAT4:RCOD?  Response: CAC</p>	<b>C/A + P</b>	<p>Not available yet.</p> <p>Carrier L1 (<math>f_{L1} = 1.57542</math> GHz) is modulated by C/A code and P-code (QPSK).</p>	<b>P</b>	<p>Not available yet.</p> <p>Carrier L1 (<math>f_{L1} = 1.57542</math> GHz) is modulated by P-code (BPSK).</p>
<b>C/A</b>	<p>Carrier L1 (<math>f_{L1} = 1.57542</math> GHz) is modulated by C/A-code (BPSK).</p> <p>Remote-control command:  SOUR:BB:GPS:SAT4:RCOD?  Response: CAC</p>						
<b>C/A + P</b>	<p>Not available yet.</p> <p>Carrier L1 (<math>f_{L1} = 1.57542</math> GHz) is modulated by C/A code and P-code (QPSK).</p>						
<b>P</b>	<p>Not available yet.</p> <p>Carrier L1 (<math>f_{L1} = 1.57542</math> GHz) is modulated by P-code (BPSK).</p>						

- Time Shift / CA-Chips/40 - GPS** Sets a delay of the selected satellite relative to the other satellites.  
Remote-control command:  
SOUR:BB:GPS:SAT4:TSCH 1233
- Time Shift ms - GPS** Indicates the time shift of the code sequence in milli seconds.  
Remote-control command:  
SOUR:BB:GPS:SAT4:TSS?
- Power - GPS** Sets the power offset of the satellite in dB. The offset determines the power ratio of the activated satellites.  
Remote-control command:  
SOUR:BB:GPS:SAT4:POW -5
- Doppler Shift - GPS** Enters the doppler shift of the simulated signal of the satellite.  
The simulation of Doppler-shifted GPS signals can be used to check the receiver characteristics under more realistic conditions than with zero Doppler. In contrast to the real system, however, the set Doppler frequency is fixed.  
The relevant change to the chip rate of the C/A code is carried out automatically. The currently valid values for Doppler-shifted carrier frequency and chip rate are displayed under **Resulting Frequency**, **Resulting C/A chip rate**, and **Resulting P chip rate**.  
Remote-control command:  
SOUR:BB:GPS:SAT:DSH 10.34kHz
- Resulting Frequency - GPS** Indicates the currently valid values for Doppler-shifted carrier frequency.  
The resulting frequency is calculated according to the following:  
$$f_{L1\text{resulting}} = f_{L1} + f_{\text{Doppler}}$$
Remote-control command:  
SOUR:BB:GPS:SAT4:FREQ?

**Resulting C/A Chip Rate - GPS**

Indicates the currently valid values for the chip rate of the C/A code. The relevant change to the chip rate of the C/A code is carried out automatically if the doppler shift is changed.

The resulting C/A chip rate is calculated according to the following:

$$f_{C/A\text{resulting}} = f_{C/A} \times \{1 + f_{\text{Doppler}} / f_{L1}\}$$

$f_{C/A}$  is fixed to 1.023 MHz.

Remote-control command:

SOUR:BB:GPS:SAT4:CA CR?

**Resulting P Chip Rate - GPS**

Indicates the currently valid values for the chip rate of the P-code. The relevant change to the chip rate of the P-code is carried out automatically if the doppler shift is changed.

The resulting P-chip rate is calculated according to the following:

$$f_{P\text{-resulting}} = f_P \times \{1 + f_{\text{Doppler}} / f_{L1}\}$$

$f_P$  is fixed to 10.230 MHz.

Remote-control command:

SOUR:BB:GPS:SAT4:PCR?

**Trigger/Marker/Clock - GPS**

The Trigger/Marker/Clock menu can be reached via the GPS main menu.

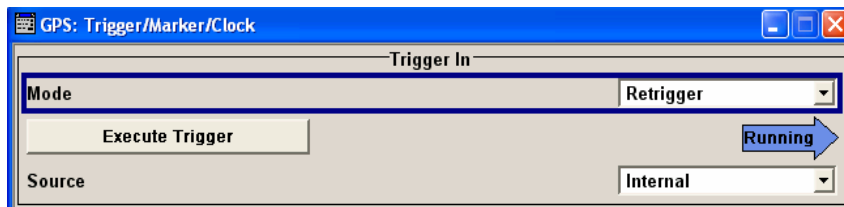

The **Trigger In** section is where the trigger for the GPS signal is set. Various parameters will be provided for the settings, depending on which trigger source - internal or external - is selected. The current status of signal generation (**Running** or **Stopped**) is indicated for all trigger modes.

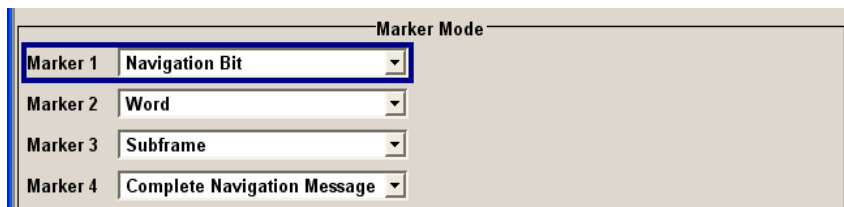

The **Marker Mode** section is where the marker signals at the MARKER output connectors are configured.



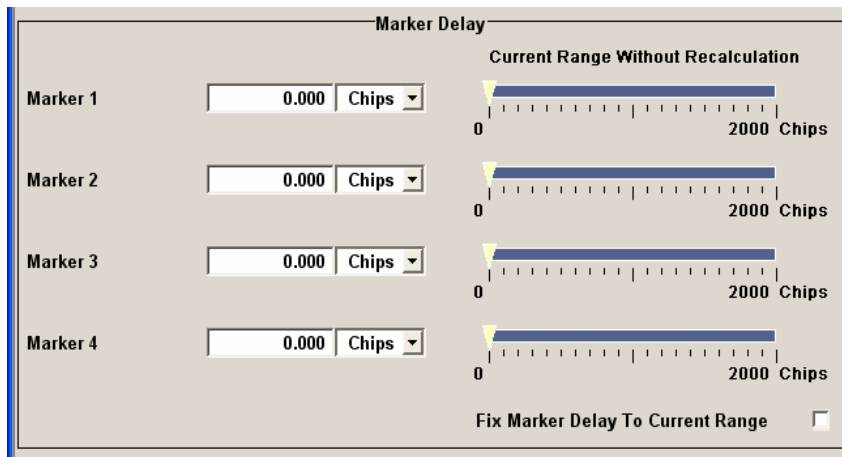

The **Marker Delay** section is where a marker signal delay can be defined, either without restriction or restricted to the dynamic section, i.e., the section in which it is possible to make settings without restarting signal and marker generation.

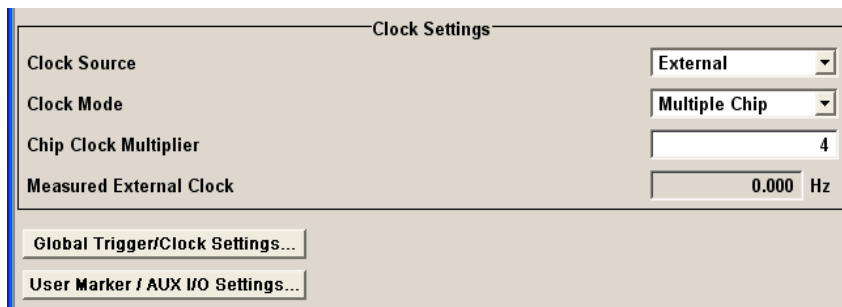

The **Clock Settings** section is where the clock source is selected and - in the case of an external source - the clock type.

The **Global Trigger/Clock Settings** button leads to a submenu for general trigger and clock settings.

The **User marker / AUX I/O Settings** button leads to a submenu for mapping the AUX I/O connector on the rear of the instrument

The **Trigger In** section is where the trigger for the GPS signal is set. The current status of the signal generation is displayed for all trigger modes.

**Trigger Mode - GPS**

Selects trigger mode.

The trigger mode determines the effect of a trigger on the signal generation.

**Auto**

The GPS signal is generated continuously..

Remote-control command:

SOUR:BB:GPS:SEQ AUTO

**Retrigger**

The GPS signal is generated continuously. A trigger event (internal or external) causes a restart.

Remote-control command:

SOUR:BB:GPS:SEQ RETR

**Armed\_Auto** The GPS-Signal signal is generated only when a trigger event occurs. Then the signal is generated continuously.

Button **Arm** stops signal generation. A subsequent trigger event (internal with **Execute Trigger** or external) causes a restart.

Remote-control command:

SOUR:BB:GPS:SEQ AAUT

**Armed\_Retrigge** The GPS-Signal signal is generated only when a trigger event occurs. Then the signal is generated continuously. Every subsequent trigger event causes a restart.

Button **Arm** stops signal generation. A subsequent trigger event (internal with **Execute Trigger** or external) causes a restart.

Remote-control command:

SOUR:BB:GPS:SEQ ARET

**Single** The GPS signal is generated only when a trigger event occurs. Then the signal is generated once to the length specified at **Signal Duration**. Every subsequent trigger event (internal with **Execute Trigger** or external) causes a restart.

Remote-control command:

SOUR:BB:GPS:SEQ SING

#### Trigger Signal Duration Unit - GPS

Defines the unit for the entry of the length of the signal sequence to be output in the **Single** trigger mode. Available units are **Subframe**, **Chip**, **Navigation Bit** or **Complete Navigation Message**.

Remote-control commands:

SOUR:BB:GPS:TRIG:SLUN CHIP

#### Trigger Signal Duration - GPS

Defines the length of the signal sequence to be output in the **Single** trigger mode. The input is to be expressed in chips. It is then possible to output deliberately just part of the signal, an exact sequence of the signal, or a defined number of repetitions of the signal.

Remote-control commands:

SOUR:BB:GPS:TRIG:SLEN 2000

**Running - Stopped - GPS** Displays the status of signal generation for all trigger modes. This display appears only when GPS is enabled (**State On**).

Remote-control command:

SOUR:BB:GPS:TRIG:RMOD?

Response: RUN or STOP

**Running** The GPS modulation signal is generated; a trigger was (internally or externally) initiated in triggered mode.

If **Armed\_Auto** and **Armed\_Retrigger** have been selected, generation of signals can be stopped with the **Arm** button. A new trigger (internally with **Execute Trigger** or externally) causes a restart.

**Stopped** The signal is not generated, and the instrument waits for a trigger event (internal or external).

**Arm - GPS** Stops signal generation. This button appears only with **Running** signal generation in the **Armed\_Auto** and **Armed\_Retrigger** trigger modes.

Signal generation can be restarted by a new trigger (internally with **Execute Trigger** or externally).

Remote-control command:

SOUR:BB:GPS:TRIG:ARM:EXEC

**Execute Trigger - GPS** Executes trigger manually. A manual trigger can be executed only when an internal trigger source and a trigger mode other than Auto have been selected.

Remote-control commands:

SOUR:BB:GPS:TRIG:SOUR INT

SOUR:BB:GPS:SEQ RETR

SOUR:BB:GPS:TRIG:EXEC

**Trigger Source - GPS** Selects trigger source. This setting is effective only when a trigger mode other than Auto has been selected.

**Internal** The trigger event is executed by **Execute Trigger**.

Remote-control command::

SOUR:BB:W3GP:TRIG:SOUR INT

**Internal (Baseband A/B)** The trigger event is executed by the trigger signal from the second path (two-path instruments only).

Remote-control command:

```
SOUR:BB:W3GP:TRIG:SOUR OBAS
```

**External (TRIGGER 1 / 2)** The trigger event is executed with the aid of the active edge of an external trigger signal. The trigger signal is supplied via the TRIGGER 1 or TRIGGER 2 connector.

The polarity, the trigger threshold and the input impedance of the TRIGGER input can be set in the menu.

Remote-control command:

```
SOUR:BB:W3GP:TRIG:SOUR EXT | BEXT
```

### Trigger Delay - GPS

Sets trigger signal delay in chips on external triggering or on internal triggering via the second path.

This enables the R&S Vector Signal Generator to be synchronized with the device under test or other external devices.

---

**Note:**

*The delay can be set separately for each of the two paths.*

---

Remote-control command::

```
SOUR:BB:GPS:TRIG:EXT:DEL 3
```

```
SOUR:BB:GPS:TRIG:OBAS:DEL 3
```

### Trigger Inhibit - GPS

(only Trigger Source External / Internal Other baseband.)

Sets the duration for inhibiting a new trigger event subsequent to triggering. The input is to be expressed in chips.

In the **Retrigger** mode every trigger signal causes signal generation to restart. This restart is inhibited for the specified number of chips.

This parameter is only available on external triggering or on internal triggering via the second path.

---

**Note:**

*The trigger inhibit can be set separately for each of the two paths.*

---

Remote-control command:

```
SOUR:BB:GPS:TRIG:EXT:INH 1000
```

```
SOUR:BB:GPS:TRIG:OBAS:INH 1000
```

The marker output signal for synchronizing external instruments is configured in the **Marker Settings** section **Marker Mode**.

### Marker Mode - GPS

Selects a marker signal for the associated MARKER output. The marker signal is always related to the first active satellite.

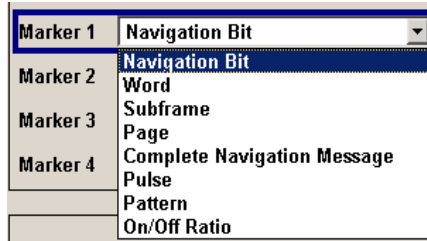

**Navigation Bit** A marker signal is generated for every navigation data bit (20460 C/A chips)

Remote-control command:

SOUR:BB:GPS:TRIG:OUTP1:MODE NBIT

**Word** A marker signal is generated for every navigation data word (30 navigation bits).

Remote-control command:

SOUR:BB:GPS:TRIG:OUTP1:MODE WORD

**Subframe** A marker signal is generated for every navigation subframe (corresponds to 10 words).

Remote-control command:

SOUR:BB:GPS:TRIG:OUTP1:MODE SFR

**Page** A marker signal is generated for every navigation page (corresponds to 5 subframes).

Remote-control command:

SOUR:BB:GPS:TRIG:OUTP1:MODE PAGE

**Message** A marker signal is generated for every complete navigation message (corresponds to 25 pages).

Remote-control command:

SOUR:BB:GPS:TRIG:OUTP1:MODE MESS

**Pulse**

A regular marker signal is generated. The clock frequency is defined by entering a divider. The frequency is derived by dividing the chip rate by the divider. The input box for the divider opens when **Pulse** is selected, and the resulting pulse frequency is displayed below it.

Divider	8.00
Frequency	33.854 17 kHz

Remote-control commands:

```
SOUR:BB:GPS:TRIG:OUTP1:MODE PULS
SOUR:BB:GPS:TRIG:OUTP1:PULS:DIV 4
SOUR:BB:GPS:TRIG:OUTP1:PULS:FREQ?
```

**Pattern**

A marker signal that is defined by a bit pattern is generated. The pattern has a maximum length of 32 bits and is defined in an input field which opens when **pattern** is selected.

0000 0000
-----------

Remote-control commands:

```
SOUR:BB:GPS:TRIG:OUTP1:MODE PATT
SOUR:BB:GPS:TRIG:OUTP1:PATT #B1111,4
```

**ON/OFF ratio**

A regular marker signal that is defined by an ON/OFF ratio is generated. A period lasts one ON and OFF cycle.

Start of signal

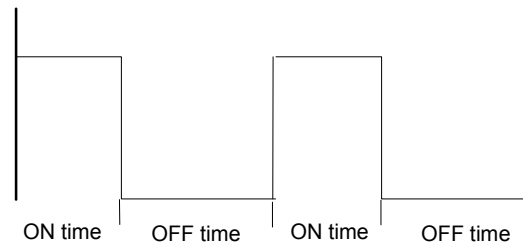

The ON time and OFF time are each expressed as a number of symbols and are set in an input field which opens when **ON/OFF ratio** is selected.

On Time	2	Sym
Off Time	3	Sym

Remote-control commands:

```
SOUR:BB:GPS:TRIG:OUTP1:MODE RAT
SOUR:BB:GPS:TRIG:OUTP1:OFFT 20
SOUR:BB:GPS:TRIG:OUTP1:ONT 20
```

The **Marker Delay** section can be used to set a delay for the markers.

**Marker x Delay - GPS**

Enters the delay between the marker signal at the marker outputs and the start of the signal.

The input is expressed as a number of samples.

If the setting "**Fix Marker Delay To Current range**" is enabled, the setting range is restricted to the dynamic range. In this range the delay of the marker signals can be set without restarting the marker and signal.

The allocation of marker signals to the outputs is described in the section "[Marker Output Signals](#)".

Remote-control command:

```
SOUR:BB:GPS:TRIG:OUTP2:DEL 20
```

**Current Range without Calculation - GPS**

Displays the dynamic range within which the delay of the marker signals can be set without restarting the marker and signal.

The delay can be defined by moving the setting mark.

Remote-control command:

```
SOUR:BB:GPS:TRIG:OUTP2:DEL:MAX?
```

```
SOUR:BB:GPS:TRIG:OUTP2:DEL:MIN?
```

**Fix marker delay to current range - GPS**

Restricts the marker delay setting range to the dynamic range. In this range the delay can be set without restarting the marker and signal.

Remote-control command:

```
SOUR:BB:GPS:TRIG:OUTP:DEL:FIX ON
```

The clock source is selected in the **Clock Settings** section.

**Clock Source - GPS**

Selects the clock source (see section "[Clock Signals](#)").

**Intern**

The internal clock reference is used to generate the chip clock.

Remote-control command:

```
SOUR:BB:GPS:CLOC:SOUR INT
```

**Extern** The external clock reference is fed in as the chip clock or multiple thereof via the CLOCK connector.

The chip rate must be correctly set to an accuracy of  $\pm 2\%$  (see data sheet).

The polarity of the clock input can be changed with the aid of **Global Trigger/Clock Settings**.

In the case of two-path instruments this selection applies to path A.

Remote-control command:  
SOUR:BB:GPS:CLOC:SOUR EXT

**Clock Mode - GPS**

**(This feature is available for external clock source only.)**

Enters the type of externally supplied clock.

**Chip** A chip clock is supplied via the CLOCK connector.

Remote-control command:  
SOUR:BB:GPS:CLOC:MODE CHIP

**Multiple** A multiple of the chip clock is supplied via the CLOCK connector; the chip clock is derived internally from this.

The **Multiplier** window provided allows the multiplication factor to be entered.

Remote-control command:  
SOUR:WIM:CLOC:MODE MCH

**Chip Clock Multiplier - GPS** Enters the multiplication factor for clock type **Multiple**.

Remote-control command:  
SOUR:BB:GPS:CLOC:MULT 4

**Measured External Clock - GPS**

Displays the measured frequency of the external clock signal. This enables the user to permanently monitor the frequency of the externally introduced clock.

This information is displayed only if the external clock source has been selected.

Remote-control command:



**Global Trigger/Clock Settings - GPS**

Calls the **Global Trigger/Clock/Input Settings** menu. This menu is used among other things for setting the trigger threshold, the input impedance and the polarity of the clock and trigger inputs.

In the case of two-path instruments these settings are valid for both paths. The parameters in this menu affect all digital modulations and standards, and are described in the section "[Global Trigger/Clock/Input Settings – Setup -Environment](#)".

**User Marker / AUX I/O Settings - GPS**

Calls the **User Marker AUX I/O Settings** menu. This menu is used to map the connector on the rear of the instruments are described in section "[User Marker - AUX IO - Setup-Environment-Global...Settings](#)".

# Digital Standard TD-SCDMA

## Introduction - TD-SCDMA (3GPP TDD LCR)

TD-SCDMA (3GPP TDD LCR) designates a mobile radio transmission method developed for 3G mobile communication by the China Wireless Telecommunication Standard group (CWTS, <http://www.cwts.org>). This standard is similar to the 3GPP TDD proposition, but with greater emphasis placed on GSM compatibility and with a chip rate limited to 1.28 Mcps. TD-SCDMA is one option of UTRA-TDD, called 1.28Mcps TDD or low chip rate (LCR) TDD.

The equipment layout for TD-SCDMA (Time Division Synchronous Code Division Multiple Access) signal generation includes the options Baseband Main Module (B13), Baseband Generator (B10/B11) and (Digital Standard TD-SCDMA (K50). B10 features a much larger ARB memory size than B11 (see data sheet). But apart from the memory size, both options have the same functionality and are installed alternatively.

Option TD-SCDMA (3GPP TDD LCR) enhanced MS/BS tests incl. HSDPA (K51) extends the TD-SCDMA signal generation with simulation of high speed channels in the downlink (HS-SCCH, (HS-SCCH, HS-PDSCH) and the uplink (HS-SICH) and with channel coding for BCH in real time and a reference measurement channel. HSDPA (high speed downlink packet access) mode enhances the TD:SCDMA standard by data channels with high data rates especially for multi media applications.

In the case of two-path instruments, at least one more option, the Baseband Generator (B10/B11) is required to generate a TD-SCDMA signal in the second path. With this option, a TD-SCDMA signal can be defined on path B and then either be routed to path A or added to the path A signal with a settable frequency offset. Generating the TD-SCDMA signal simultaneously on paths A and B requires an additional, second option, the (Digital Standard TD-SCDMA (K50). With a full path B configuration with a second option Baseband Main Module (B13) and an RF section (frequency option B20x) the TD-SCDMA signal can be output at RF output B.

TD-SCDMA is a mobile radio standard in which available bandwidth is divided among subscribers according to frequency (FDMA), time (TDMA) and code (CDMA). The same frequency is used for both directions of transmission (TDD). Each resource (i.e. a combination of frequency, code and time slot) can be used simultaneously by several base stations or user equipments provided the scrambling codes differ. A cell is understood to be a base station and all user equipments communicating with this base station. The R&S Vector Signal Generator simulates a maximum of four cells at the same frequency. The Multi Carrier Mode can be used to simulate more than four cells at the same frequency or cells at several frequencies.

The TD-SCDMA signals are generated in a combination of realtime mode (real time channels) and arbitrary waveform mode. Simulation of bit and block errors can be activated for the channels generated in realtime (requires option K51). In arbitrary waveform mode, the signal is first calculated and then output.

The R&S Vector Signal Generator simulates TD-SCDMA at the physical channel layer. The following list gives an overview of the options provided by the R&S Vector Signal Generator for generating a TD-SCDMA signal:

- Configuration of up to four TD-SCDMA cells with variable switching point of uplink and downlink.
- Freely configurable channel table for each slot and simulation of the downlink and uplink pilot time slot.
- Real time generation of one traffic channel and the SYNC channel on the downlink
- Slot modes "Dedicated" and "PRACH" on the uplink.
- Clipping for reducing the crest factor

Table 4-31 Parameters of the modulation system TD-SCDMA

Parameter	Value
Chip rate	1.28 Mcps
Carrier spacing	1.6 MHz
Data modulation	QPSK
Filter	Root-raised cosine (0.22)
Channel types	Downlink : <ul style="list-style-type: none"> <li>• Primary Common Control Physical Channel (P-CCPCH)</li> <li>• Secondary Common Control Physical Channel (S-CCPCH)</li> <li>• Physical Forward Access Channel (F-FACH)</li> <li>• Downlink Pilot Time Slot (DwPTS)</li> <li>• Dedicated Physical Channel (DPCH)</li> </ul> Uplink : <ul style="list-style-type: none"> <li>• Physical Random Access Channel (P-RACH)</li> <li>• Uplink Pilot Time Slot (UpPTS)</li> <li>• Dedicated Physical Channel (DPCH)</li> </ul>
Data rates	17.6 kbps, 35.2 kbps, 70.4 kbps to 281.6 kbps depending on channel type
Number of channels	4 cells, each containing max. 7 active slots. Each slot with up to 16 DPCHs and 5 special channels.
Frame structure	Frame: 5 ms with 7 (traffic) time slots Time slot (traffic): 675 $\mu$ s Time slot (DwPTS): 75 $\mu$ s Time slot (UpPTS): 125 $\mu$ s The number of symbols transmitted in a slot depends on the symbol rate.
Scrambling code	128 different codes with length of 16 chips
SYNC codes	32 different codes with length of 64 chips
SYNC1 codes	256 different codes with length of 128 chips
Basic midamble codes	128 different codes with length of 128 chips
Spreading code	"Orthogonal Variable Spreading Factor Code (OVSF)"; spreading factors 1, 2, 4, 8, 16

# Modulation System TD-SCDMA

## TD-SCDMA Signal Structure (Frames and Time Slots)

The TD-SCDMA signal is organized in frames of 5 ms length. Each frame comprises 7 traffic time slots (Ts0 to Ts6, each 0.675 ms) and two special time slots (DwPTS and UpPTS) for synchronization.

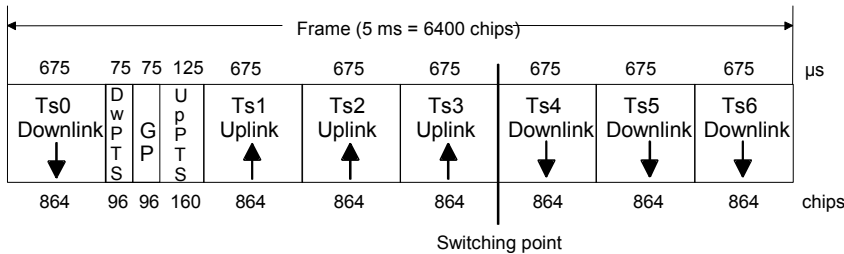

Fig. 4-58 Structure of TD-SCDMA frame

Ts0 is always allocated to the downlink, Ts1 to the uplink. The other time slots are divided between the two directions of transmission, the switching point being variable.

## DwPTS and UpPTS

In the downlink pilot time slot (DwPTS), the base station sends one of 32 possible 64-chip SYNC codes. The SYNC code allows the user equipment to synchronize to the base station. At the same time, the SYNC code defines the value range for the scrambling code and the basic midamble code.

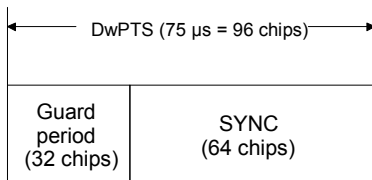

Fig. 4-59 Structure of DwPTS

The real-valued SYNC sequence is converted into a complex-valued SYNC sequence by a rotating-vector operation.

This SYNC sequence is divided up into four symbols with 16 chips each. The symbols are phase-modulated (possible phases are 45°, 135°, 225° and 315°) in order to signal the frame number of the interleaver.

In the supplied software, all symbols are modulated with 45°.

The uplink pilot time slot (UpPTS) is sent by the user equipment to initiate a call with the base station (before a P-RACH is sent, for example). The transmitted SYNC1 code is randomly selected from eight possible codes. If the base station does not respond to the UpPTS, the UpPTS is repeated in the next frame.

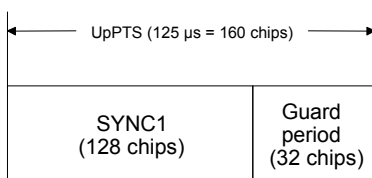
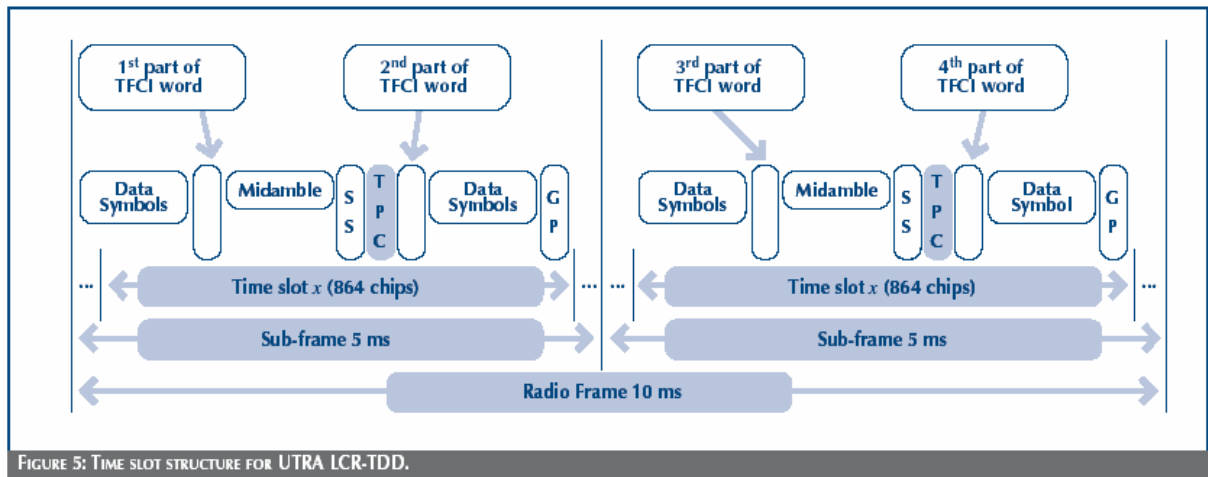

Fig. 4-60 Structure of UpPTS

The UpPTS is a complex-valued signal resulting from the real SYNC1 sequence by a rotating-vector operation.

## Structure of Traffic Burst

In time slots Ts0 to Ts6, bursts can be sent by the base station or the user equipment, i.e. in both directions of transmission. The burst structure is identical for both directions. There are two types of burst, however, which are described in the following.



### Burst Without Layer 1 Control Information

This type of burst can be used for all physical channels. It comprises two data fields, a midamble and a guard period.

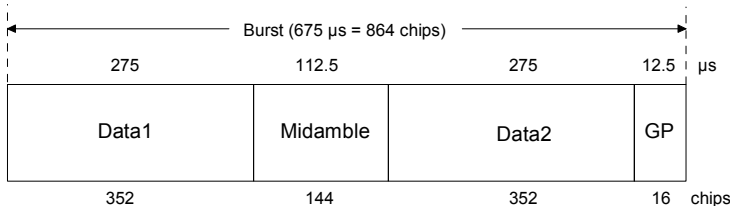

Fig. 4-61 Traffic burst without layer 1 control information

The useful data are

- alternately fed to the I and the Q path (QPSK data modulation),
- mapped from the 0/1 plane into the  $-1/+1$  plane,
- spread with the complex spreading code (spreading factor SF = 1, 2, 4, 8 or 16),
- scrambled with the real-valued scrambling code,
- weighted with the channel power and
- filtered (root-raised cosine 0.22)

Since each user sends only one burst per frame, the following gross data rate is obtained:

$$Gross\_Data\_Rate = \frac{704 * 2}{SF * 5ms} = 281600/SF \text{ kbit/s}$$

The midamble is obtained from the basic midamble by periodic repetition and shifting. For some channels, the midamble shift can be set in steps of 8 chips. The basic midamble is 128 chips long, while the length for the midamble field in the time slot is 144 chips. Each scrambling code (setting parameter at cell level) is assigned a basic midamble code.

The midamble is neither spread nor scrambled.

No signal is transmitted during the guard period. This avoids crosstalk of the burst into the next time slot at the receiver end.

**Burst With Layer 1 Control Information**

This type of burst can be used only with DPCCHs (dedicated physical channels). It differs from the "normal" burst only in that the data fields are shortened ahead of and after the midamble to enable the transmission of layer 1 control information.

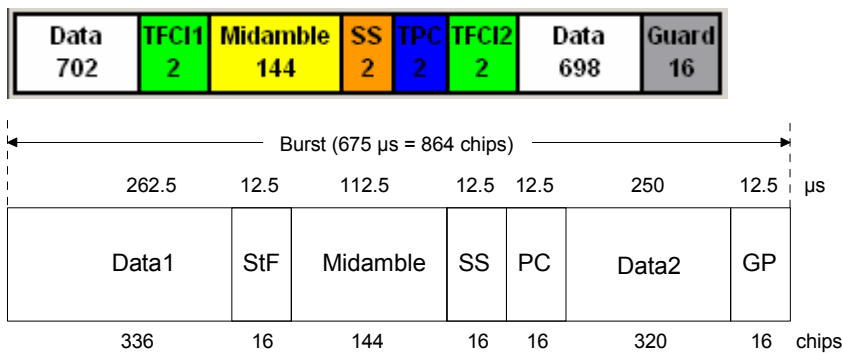

Fig. 4-62 Traffic burst with layer 1 control information

The burst consists of two fields of data symbols, a fixed-length 144 chip midamble, and control fields for Synchronization Shift (SS), Transmit Power Control (TPC), and Transport Format Indicator (TFCI). The timeslot is delimited by a 16-chip guard period (GP).

Each data field consists of a maximum of 352 chips.

The Transport Format Indicator field (TFCI) conveys transport format information to the receiver, which is used by the channel decoder to recover transport channels. The information is distributed into two segments in one burst (four segments in two burst = one frame)

The synchronization shift (SS) field is used to inform the other station of a shift of the burst time ("00" means that the sync shift is increased, "11" that it is decreased). The bits are transmitted in *M* consecutive frames. The shift value is a multiple *k* of  $T_{chip}/8$ . *M* and *k* are transmitted by signalling. The value for *M* (Sync Shift Repetition) can be selected.

Analogously to the Sync Shift field, the power control (TPC) field is used to initiate an increase or decrease of transmit power.

If the spreading factor SF is lower than 16, the control symbols are transmitted 16/SF times. Control symbols are treated like data symbols, i.e. they are spread and scrambled.

# TD-SCDMA Menu

The menu for setting the TD-SCDMA digital standard is either called from the baseband block or from the menu tree under **Baseband**.

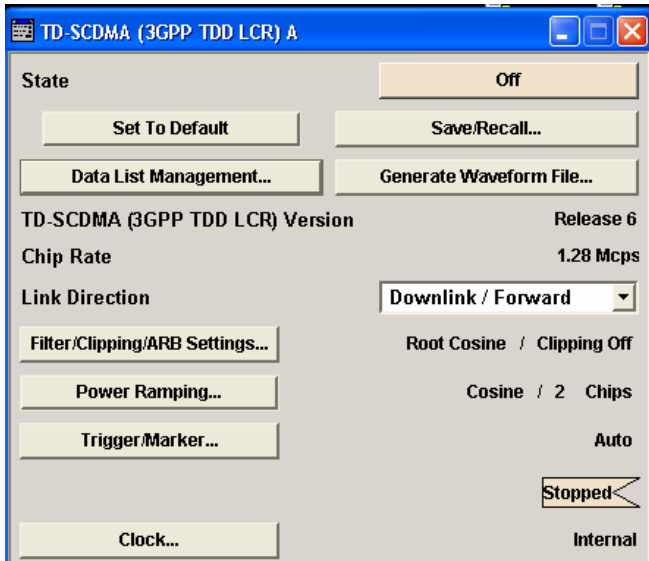
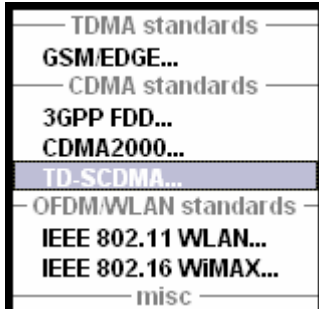

The upper section of the menu is where the TD-SCDMA digital standard is enabled, the default settings are called, and the transmission direction selected.

The valid TD-SCDMA version and the chip rate in use are displayed.

Many of the buttons lead to submenus for loading and saving the TD-SCDMA configuration and for setting the filter, trigger, and clock parameters.

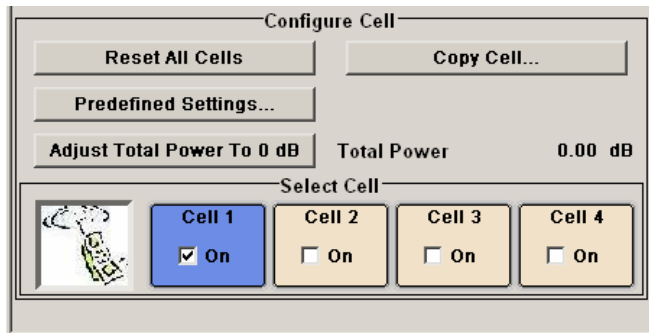

The lower menu section is where the cells are selected for signal configuration.

## General Settings for TD-SCDMA Signals

The upper menu section is where the TD-SCDMA digital standard is enabled and reset and where all the settings valid for the signal in both transmission directions are made.

### State – TD-SCDMA

Activates or deactivates the TD-SCDMA standard.

Activating this standard deactivates all the other digital standards and digital modulation modes on the same path.

The TD-SCDMA signal is generated by a combination of realtime mode (enhanced channels) and arbitrary waveform mode (all the other channels).

On the downlink, one traffic channel and the SYNC channel of cell 1 are generated in realtime. All the other channels are generated in arbitrary waveform mode and added.

In the uplink, all the channels of cell 1 are generated in realtime, the other cells are generated in arbitrary waveform mode and added to the realtime signal.

Remote-control command:  
SOUR:BB:TDSC:STAT ON

### Set To Default - TD-SCDMA

Calls the default settings, see Section [“Reset All Base Stations - CDMA2000”](#), page 4.533.

The link direction is set to downlink. In order to get a signal, the following settings are performed for both link directions:

#### For downlink cells

Cell 1 is activated (State = ON), slot 0 is activated, and channel 0 and 1 are activated.

#### For uplink cells

Cell 1 is activated, slot 1 is activated, and channel 1 is activated.

Remote-control command:  
SOUR:BB:TDSC:PRES

Parameter	Value
Link Direction	Downlink/Forward
Filter	Root Cosine
Clipping	Off
Power ramping	Cosine / 2 chips
Trigger	Auto



**Save/Recall...** - TD-SCDMA Calls the **Save/Recall** menu.

From the **Save/Recall** menu, the **File Select** windows for saving and recalling TD-SCDMA configurations and the **File Manager** is called.



TD-SCDMA configurations are stored as files with the predefined file extension **\*.tdscdma**. The file name and the directory they are stored in are user-definable.

The complete settings in the **TD-SCDMA** menu are saved and recalled.

**Recall TD-SCDMA Setting** Opens the **File Select** window for loading a saved TD-SCDMA configuration.

The configuration of the selected (highlighted) file is loaded by pressing the **Select** button.

Remote-control command:

```
MMEM:CDIR 'F:\gen_list\tdscdma'
```

```
SOUR:BB:TDSC:SETT:CAT?
```

```
Response: 'tdscdma_1', 'tdscdma_2'
```

```
SOUR:BB:TDSC:SETT:LOAD "tdscdma_1"
```

**Save TD-SCDMA Setting** Opens the **File Select** window for saving the current TD-SCDMA signal configuration.

The name of the file is specified in the **File name** entry field, the directory selected in the **save into** field. The file is saved by pressing the **Save** button.

Remote-control command:

```
MMEM:CDIR 'F:\gen_list\tdscdma'
```

```
SOUR:BB:TDSC:SETT:STOR "tdscdma_1"
```

**File Manager** Calls the **File Manager**.

The **File Manager** is used to copy, delete, and rename files and to create new directories.

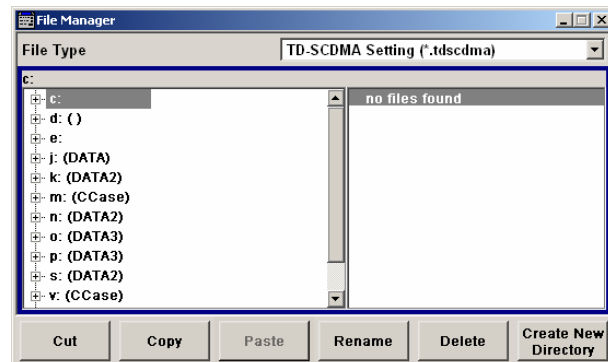

Remote-control command:

```
MMEM:CDIR 'F:\gen_list\tdscdma'
```

```
SOUR:BB:TDSC:SETT:DEL "tdscdma_1"
```

**Data List Management... - TD-SCDMA**

Calls the **Data List Management** menu. This menu is used to create and edit a data list.

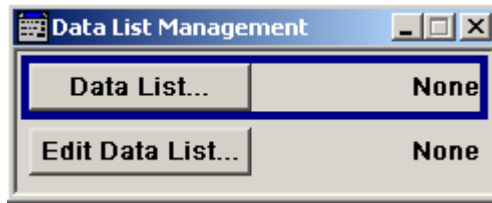

All data lists are stored as files with the predefined file extension **\*.dm\_iqd**. The file name and the directory they are stored in are user-definable.

The data lists must be selected as a data source from the submenus under the individual function, e.g. in the channel table of the cells.

Remote-control commands:

**Note:**

*All data lists are generated and edited by means of the **SOURce:BB:DM** subsystem commands. Files containing data lists usually end with **\*.dm\_iqd**. The data lists are selected as a data source for a specific function in the individual subsystems of the digital standard.*

**Creating and editing the data list:**

```
SOUR:BB:DM:DLIS:SEL "d_list1"
SOUR:BB:DM:DLIS:DATA #B1111010101000001111....
SOUR:BB:DM:DLIS:DATA:APP #B1111010101000001111....
```

**Selecting the data list:**

```
SOUR:BB:TDSC:DOWN|UP:CELL1:SLOT2:CHAN5:DATA DLIS
SOUR:BB:TDSC:DOWN|UP:CELL1:SLOT2:CHAN5:DATA:DSEL
"tdscdma_1"
```

```
SOUR:BB:TDSC:DOWN|UP:CELL1:SLOT2:CHAN5:DPCC:TPC:DATA DLIS
SOUR:BB:TDSC:DOWN|UP:CELL1:SLOT2:CHAN5:DPCC:TPC:DATA:DSEL
"tdscdma_1"
```

```
SOUR:BB:TDSC:DOWN:CELL1:ENH:BCH:DTCH:DATA DLIS
SOUR:BB:TDSC:DOWN:CELL1:ENH:BCH:DTCH:DATA:DSEL
"tdscdma_1"
```

```
SOUR:BB:TDSC:DOWN|UP:CELL1:ENH:DCH:DTCH|DCCH:DATA DLIS
SOUR:BB:TDSC:DOWN|UP:CELL1:ENH:DCH:DTCH|DCCH:DATA:DSEL
"tdscdma_1"
```

```
SOUR:BB:TDSC:UP:CELL1:SLOT2:PRAC:MSG:DATA DLIS
SOUR:BB:TDSC:UP:CELL1:SLOT2:PRAC:MSG:DSEL
"tdscdma_1"
```

**Generate Waveform File... - TD-SCDMA** - Calls the **Generate Waveform** menu. This menu is used to store the current TD-SCDMA signal as ARB signal in a waveform file.

This file can be loaded in the **ARB** menu and processed as multicarrier or multisegment signal.

The file name is entered in the submenu. The file is stored with the predefined file extension \*.**wv**. The file name and the directory it is stored in are user-definable.

Remote-control commands:

SOUR:BB:TDSC:WAV:CRE "c:\temp\tdscdma.wv"

**TD-SCDMA Version - TD-SCDMA**

Displays the current version of the TD-SCDMA standard.

The default settings and parameters provided are oriented towards the specifications of the version displayed.

Remote-control command:

SOUR:BB:TDSC:VERS?

Response: Release 6

**Chip Rate - TD-SCDMA**

Displays the system chip rate. This is fixed at 1.28 Mcps.

The output chip rate can be varied in the Filter, Clipping, ARB Settings menu (see section "[Filtering](#), Clipping, ARB Settings - CDMA2000", page 4.555).

Remote-control command:

SOUR:BB:TDSC:CRAT?

Response: R1M28

**Link Direction - TD-SCDMA** Selects the transmission direction.

The settings of the base station or the user equipment are provided in the following menu section in accordance with the selection.

**Downlink/  
Forward**

The transmission direction selected is base station to user equipment. The signal corresponds to that of a base station.

Remote-control command:

SOUR:BB:TDSC:LINK DOWN

**Uplink/  
Reverse**

The transmission direction selected is user equipment to base station. The signal corresponds to that of a user equipment.

Remote-control command:

SOUR:BB:TDSC:LINK UP

**Filtering, Clipping, ARB Settings - TD-SCDMA**

Calls the menu for setting baseband filtering, clipping, and the sequence length of the arbitrary waveform component. The current filter and the clipping state are displayed next to the button.

The menu is described in Section "[Filtering, Clipping, ARB Settings - CDMA2000](#)", page 4.555.

Remote-control command: n.a.

**Power Ramping... - TD-SCDMA**

Calls the menu for setting the power ramping.

The menu is described in Section "[Power Ramping- TD-SCDMA](#)", page 4.555.

Remote-control command: n.a.

**Trigger - Marker - TD-SCDMA**

Calls the menu for selecting the trigger mode and trigger source, for configuring the marker signals, and for setting the time delay of an external trigger signal (see Section "[Trigger-Marker-Clock - CDMA2000](#)", page 4.560).

The currently selected trigger mode and trigger source are displayed next to the button.

Remote-control command: n.a.

**Execute Trigger - TD-SCDMA**

Executes trigger manually.

A manual trigger can be executed only if an internal trigger source and a trigger mode other than **Auto** have been selected.

Remote-control command:

SOUR:BB:TDSC:TRIG:EXEC

**Arm - TD-SCDMA**

Stops signal generation manually.

The **Arm** button is displayed only if the trigger modes **Armed Retrigger** or **Armed Auto** have been selected.

Remote-control command:

SOUR:BB:TDSC:TRIG:ARM:EXEC

**Clock - TD-SCDMA**

Calls the menu for selecting the clock source and for setting a delay(see Section "[Trigger-Marker-Clock - CDMA2000](#)", page 4.560).

Remote-control command: n.a.

In the lower menu section, the cells can be reseted to the predefined settings, parameters of one cell can be copied to another cell, and the total power can be set to 0 dB. Each cell can be activated or deactivated. Active cells are highlighted blue. Clicking a cell opens the configuration menu for setting the cell parameters.

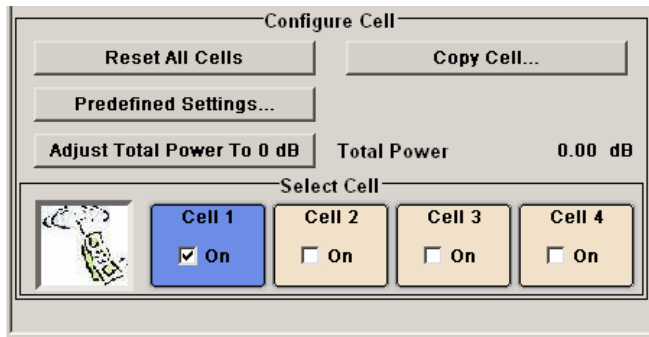

**Reset All Cells - TD-SCDMA**

Resets all cells to the predefined settings. The reset applies to the selected link direction. The following table gives an overview of the settings. The preset value for each parameter is specified in the description of the remote-control commands.

Remote-control command:

SOUR:BB:TDSC:RES

Cell Configuration	
State	OFF
(Use) Scrambling Code	ON
Scrambling Code (value)	0
SYNC-DL Code	0
SYNC-UL Code	0
Basic Midamble Code ID	0
Number of Users	16
Switching Point	3
DwPTS Power	0.0 dB
Slot Configuration	
State	OFF
Slot Mode (only in uplink)	Dedicated

Channel Configuration	
State	OFF
Channel Type	Depending on channel number
Current User	1
Slot Format	0
Spreading Factor	16
Spreading Code	0
Power	0 dB
Data Source	PRBS: PN9, Data Pattern: 0
Number of TFCI bits	0
TFCI Value	0
Number of Sync Shift & TPC bits	0 & 0
Sync Shift Pattern	1
Sync Shift Repetition M	1
TPC Source/TPC Pattern	01
Read Out Mode	Continuous

**Copy Cell... - TD-SCDMA**

Copies the settings of a cell to a second cell. A window opens for creating the destination station.

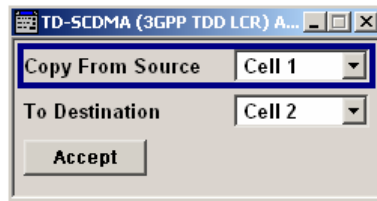
**Copy From Source**

Selects the cell whose settings are to be copied.

Remote-control command:

SOUR:BB:TDSC:COPY:SOUR 1

**To Destination**

Selects the cell whose settings are to be overwritten.

Remote-control command:

SOUR:BB:TDSC:COPY:DEST 2

**Accept**

Starts the copy process.

Remote-control command:

SOUR:BB:TDSC:COPY:EXEC

**Predefined Settings - TD-SCDMA**

Calls the menu for setting predefined configurations.

The menu is described in Section "[Predefined Settings - TD-SCDMA](#)", page 4.768.

Remote-control command: n.a.

**Adjust Total Power to 0dB - TD-SCDMA**

Sets the power of an enabled channel so that the total power of all the active channels is 0 dB. This does not change the power ratio among the individual channels.

Remote-control command:

SOUR:BB:TDSC:POW:ADJ

**Total Power - TD-SCDMA**

Displays the total power of the active channels for the selected link direction.

The total power is calculated from the power ratio of the powered up code channels with modulation on. If the value is not equal to 0 dB, the individual code channels (whilst still retaining the power ratios) are internally adapted so that the **Total Power** for achieving the set output level is 0 dB.

Remote-control command:

SOUR:BB:TDSC:POW:TOT?

Response: 0.00 dB

**Select Cell - TD-SCDMA**

Selects the cell by pressing the accompanying button.

This opens a menu for editing the selected cell.

The menu is described in Section "[Cell Configuration - TD-SCDMA](#)", Page 4.770 .

Remote-control command: n.a.

(the cell is selected by the keyword index CELL  
<[1] | 2 | 3 | 4>)

**Cell On Cell Off - TD-SCDMA**

Activates or deactivates the cells.

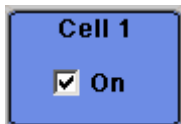

Remote-control command:

SOUR:BB:TDSC:DOWN:CELL1:STAT ON

## Filtering, Clipping, ARB Settings - TD-SCDMA

The **Filter, Clipping, ARB Settings** menu is reached via the **TD-SCDMA** main menu.

The filter parameters (**Filter** section), clipping (**Clipping** section) and the sequence length of the arbitrary waveform component (**ARB Settings** section) are defined in this menu.

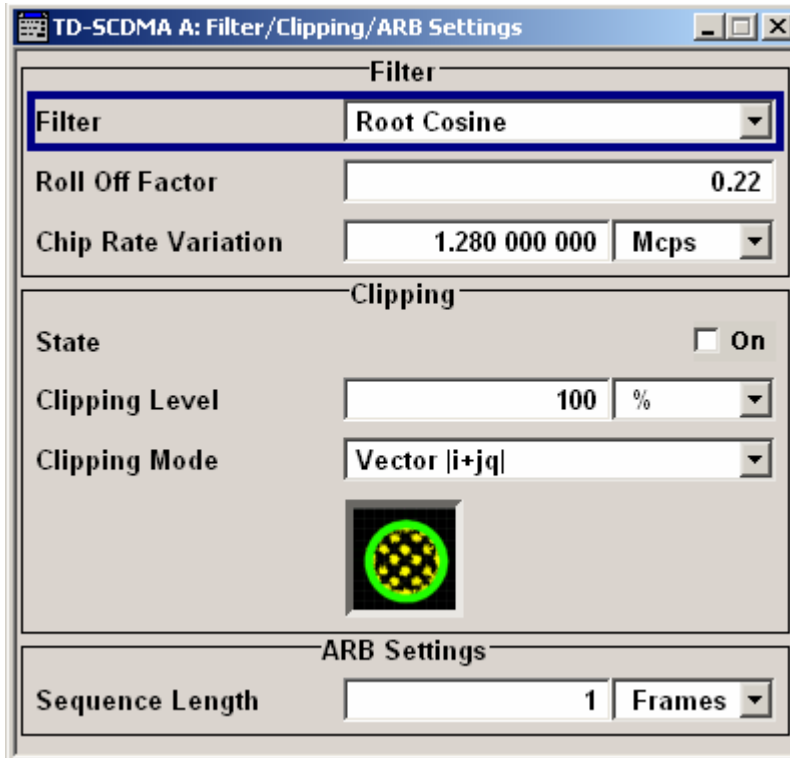

In the **Filter** section, the settings are made for the baseband filter.

### Filter - TD-SCDMA

Selects baseband filter.

This opens a selection window containing all the filters available to the instrument.

The filter types are described in Section "[Baseband Filter - Custom Digital Mod](#)".

Remote-control command:

```
SOUR:BB:TDSC:FILT:TYPE RCOS
```



**Roll Off Factor or BxT - TD-SCDMA**

Enters the filter parameters.

The filter parameter offered (**Roll Off Factor** or **BxT**) depends on the currently selected filter type. This parameter is always set to the default for each of the predefined filters.

Remote-control commands:

```
SOUR:BB:TDSC:FILT:PAR:APCO25 0.2
SOUR:BB:TDSC:FILT:PAR:COS 0.35
SOUR:BB:TDSC:FILT:PAR:GAUS 0.5
SOUR:BB:TDSC:FILT:PAR:PGA 0.5
SOUR:BB:TDSC:FILT:PAR:RCOS 0.35
SOUR:BB:TDSC:FILT:PAR:SPH 2
```

**Chip Rate Variation - TD-SCDMA**

Enters the chip rate.

The default setting for the chip rate is 1.28 Mcps.

The chip rate entry changes the output clock and the modulation bandwidth, as well as the synchronization signals that are output. It does not affect the calculated chip sequence.

Remote-control command:

```
SOUR:BB:TDSC:CRAT:VAR 1228800
```

The settings for clipping are collected in the **Clipping** section.

**Clipping State – TD-SCDMA**

Activates or deactivates the baseband clipping.

Baseband clipping is a very simple and effective way of reducing the crest factor of the TD-SCDMA signal.

TD-SCDMA signals may have very high crest factors in particular if a large number of channels and many inactive slots are involved. High crest factors entail two basic problems:

- The nonlinearity of the power amplifier (compression) causes intermodulation which expands the spectrum (spectral regrowth).
- Since the level in the D/A converter is relative to the maximum value, the average value is converted with a relatively low resolution. This results in a high quantization noise.

Both effects increase the adjacent-channel power.

With baseband clipping, all the levels are limited to a settable value (**Clipping Level**). This level is specified as a percentage of the highest peak value. Since clipping is done prior to filtering, the procedure does not influence the spectrum. The EVM however increases.

Since clipping the signal not only changes the peak value but also the average value, the effect on the crest factor is unpredictable. The following table shows the effect of the **Clipping** on the crest factor for typical scenarios.

Remote-control command:

```
SOUR:BB:TDSC:CLIP:STAT ON
```

Table 4-31 Changing the crest factor by clipping (vector mode  $|i+jq|$ ) for signal configurations with different output crest factors. 100 % clipping levels mean that clipping does not take place.

Clipping Level	Downlink + Uplink: 48 DPCHs "minimum crest"	Downlink: 48 DPCHs "minimum crest"	Downlink + Uplink: 10 DPCHs "average crest"	Downlink: 10 DPCHs "average crest"
100 %	9.47 dB	11.47 dB	7.78 dB	9.71 dB
80 %	8.77 dB	10.75 dB	6.26 dB	8.33 dB
50 %	7.33 dB	9.42 dB	6.51 dB	8.64 dB
20 %	5.82 dB	8.10 dB	4.56 dB	6.95 dB
10 %	5.69 dB	8.11 dB	4.56 dB	6.95 dB
5 %	5.80 dB	8.26 dB	4.56 dB	6.95 dB

The following pictures demonstrate the affect of clipping with vector mode  $(|i+jq|)$ , using a signal configuration with 10 active DPCHs.

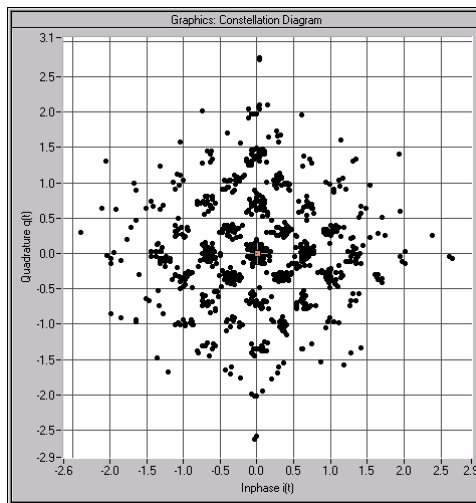

Fig. 4-63 Constellation diagram of the signal without clipping, shows the level mapping

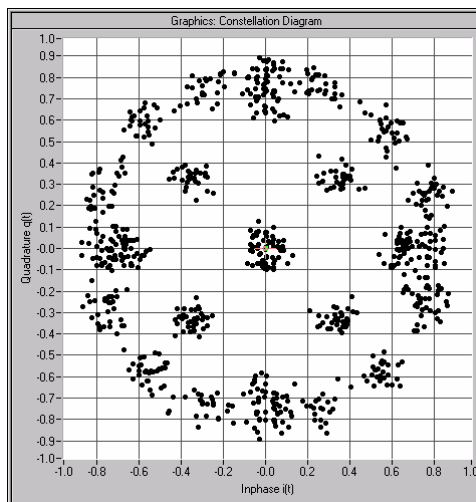

Fig. 4-64 Constellation diagram with clipping level 380 %, vector mode  $(|i+jq|)$ .

**Clipping Level- TD-SCDMA** Enters the limit for clipping.  
 This value indicates at what point the signal is clipped. It is specified as a percentage, relative to the highest level. 100% indicates that clipping does not take place.

Remote-control command:  
`SOUR:BB:TDSC:CLIP:LEV 50`

**Clipping Mode - TD-SCDMA** Selects the clipping method. A graphic illustration of the way in which these two methods work is given in the menu.

**Vector  $|i + jq|$**  The limit is related to the amplitude  $|i + q|$ . The I and Q components are mapped together, the angle is retained (see also figures above, Clipping State).

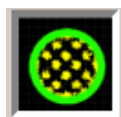

Remote-control command:  
`SOUR:BB:TDSC:CLIP:MODE VECT`

**Scalar  $|i|, |q|$**  The limit is related to the absolute maximum of all the I and Q values  $|i|, |q|$ .

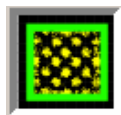

The I and Q components are mapped separately, the angle changes.

Remote-control command:  
`SOUR:BB:TDSC:CLIP:MODE SCAL`

The **ARB Settings** section is where the sequence length of the arbitrary waveform component is defined.

**Sequence Length ARB - TD-SCDMA**

Selects the sequence length of the arbitrary waveform component of the TD-SCDMA signal in the number of frames. This component is calculated in advance and output in the arbitrary waveform generator. It is added to the realtime signal components.

The number of chips is determined from this sequence length (1 Frame =10 ms) and the chip rate. At 1.2288 MChips/s a frame equals 12800 chips.

In pure amplifier tests with several channels and no real time channels, it is possible to improve the statistical properties of the signal by increasing the sequence length.

Remote-control command:  
`SOUR:BB:TDSC:SLEN 20`

## Power Ramping- TD-SCDMA

The **Power Ramping Settings** menu is reached via the **TD-SCDMA** main menu.

The menu is used to set the power ramping.

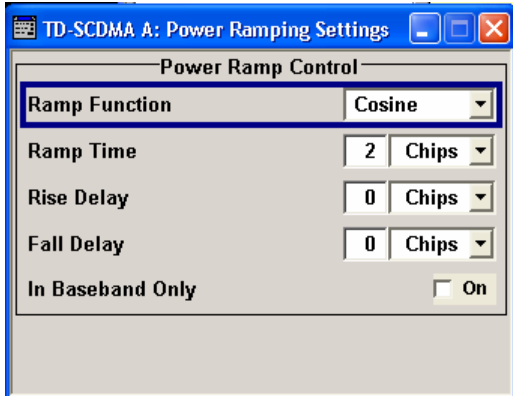

### Ramp Function - TD-SCDMA

Selects the form of the transmitted power, i.e. the shape of the rising and falling edges during power ramp control.

Remote-control command:

SOUR:BB:TDSC:PRAM:SHAP COS

#### Linear

The transmitted power rises and falls linear fashion.

Remote-control command:

SOUR:BB:TDSC:PRAM:SHAP LIN

#### Cosine

The transmitted power rises and falls with a cosine-shaped edge. This gives rise to a more favorable spectrum than the Linear setting.

Remote-control command:

SOUR:BB:TDSC:PRAM:SHAP COS

### Ramp Time- TD-SCDMA

Sets the power ramping rise time and fall time for a burst.

Remote-control command:

SOUR:BB:TDSC:PRAM:TIME 2.0

### Rise Delay- TD-SCDMA

Sets the offset in the rising edge of the envelope at the start of a burst. A positive value gives rise to a delay and a negative value causes an advance.

Remote-control command:

SOUR:BB:TDSC:PRAM:RDEL 2.0

**Fall Delay- TD-SCDMA**

Sets the offset in the falling edge of the envelope at the end of a burst. A positive value gives a rise to a delay and a negative value causes an advance.

Remote-control command:  
 SOUR:BB:TDSC:PRAM:FDEL 8.0

**In Baseband Only- TD-SCDMA**

Activates or deactivates power ramping for the baseband signals.

Remote-control command:  
 SOUR:BB:TDSC:PRAM:BBON OFF

## Trigger-Marker-Clock - TD-SCDMA

The **Trigger/Marker/Clock** menu can be reached via the **TD-SCDMA** main menu.

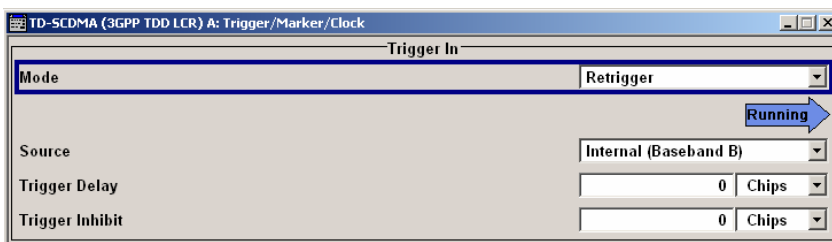

The **Trigger In** section is where the trigger for the TD-SCDMA signal is set. Various parameters are provided for the settings, depending on which trigger source - internal or external - is selected. The current status of signal generation (**Running** or **Stopped**) is indicated for all trigger modes.

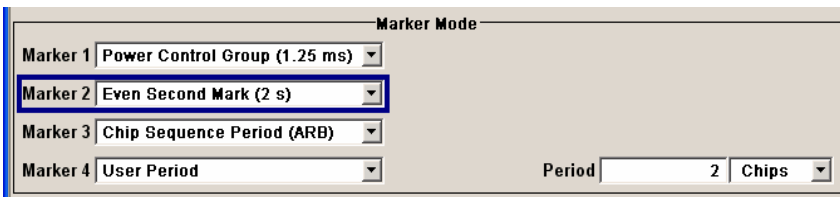

The **Marker Mode** section is where the marker signals at the MARKER output connectors are configured.

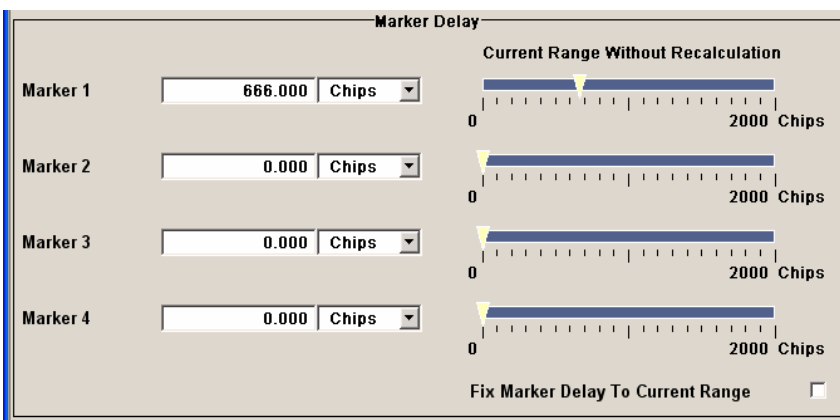

The **Marker Delay** section is where a marker signal delay is defined, either without restriction or restricted to the dynamic section, i.e., the section in which it is possible to make settings without restarting signal and marker generation.

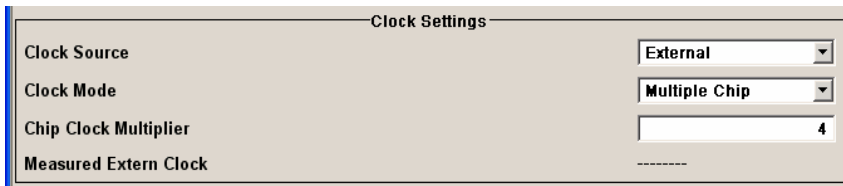

The **Clock Settings** section is where the clock source is selected and - in the case of an external source - the clock type.



The **Global Trigger/Clock Settings** button leads to a submenu for general trigger and clock settings.

The **Trigger In** section is where the trigger for the TD-SCDMA signal is set. The current status of the signal generation is displayed for all trigger modes.

**Mode - TD-SCDMA**

Selects the trigger mode.

The trigger mode determines the effect of a trigger on the signal generation.

**Auto**

The TD-SCDMA signal is generated continuously.

Remote-control command:  
SOUR:BB:TDSC:SEQ AUTO

**Retrigger**

The TD-SCDMA signal is generated continuously. A trigger event (internal or external) causes a restart.

Remote-control command:  
SOUR:BB:TDSC:SEQ RETR

**Armed Auto**

The TD-SCDMA-Signal signal is generated only when a trigger event occurs. Then the signal is generated continuously.

Clicking the button **Arm** stops signal generation. A subsequent trigger event (internal with **Execute Trigger** or external) causes a restart.

Remote-control command:  
SOUR:BB:TDSC:SEQ AAUT

**Armed Retrigger**

The TD-SCDMA-Signal signal is generated only when a trigger event occurs. Then the signal is generated continuously. Every subsequent trigger event causes a restart.

Clicking the button **Arm** stops signal generation. A subsequent trigger event (internal with **Execute Trigger** or external) causes a restart.

Remote-control command:  
SOUR:BB:TDSC:SEQ ARET

<b>Single</b>	<p>The TD-SCDMA signal is generated only when a trigger event occurs. Then the signal is generated once to the length specified at <b>Signal Duration</b>. Every subsequent trigger event (internal with <b>Execute Trigger</b> or external) causes a restart.</p> <p>Remote-control command: SOUR:BB:TDSC:SEQ SING</p>
<b>Signal Duration Unit - TD-SCDMA</b>	<p>Selects the unit for the entry of the length of the signal sequence to be output in the <b>Single</b> trigger mode. Available units are chip sequence length (CLS), chips, or frames.</p> <p>Remote-control commands: SOUR:BB:TDSC:TRIG:SLUN CHIP</p>
<b>Signal Duration - TD-SCDMA</b>	<p>Enters the length of the signal sequence to be output in the <b>Single</b> trigger mode. The unit of the entry is defined under <b>Signal Duration Unit</b>. It is possible to output deliberately just part of the frame, an exact sequence of the frame, or a defined number of repetitions of the frame.</p> <p>Remote-control commands: SOUR:BB:TDSC:TRIG:SLEN 2000</p>
<b>Running - Stopped - TD-SCDMA</b>	<p>Displays the status of signal generation for all trigger modes. This display appears only when TD-SCDMA is enabled (<b>State On</b>).</p> <p>Remote-control command: SOUR:BB:TDSC:TRIG:RMOD? Response: RUN</p>
<b>Running</b>	<p>The TD-SCDMA modulation signal is generated; a trigger was (internally or externally) initiated in triggered mode.</p> <p>If <b>Armed Auto</b> or <b>Armed Retrigger</b> have been selected, generation of signals can be stopped with the <b>Arm</b> button. A new trigger (internally with <b>Execute Trigger</b> or externally) causes a restart.</p>
<b>Stopped</b>	<p>The signal is not generated and the instrument waits for a trigger event (internal or external).</p>
<b>Arm - TD-SCDMA</b>	<p>Stops signal generation. This button appears only with <b>Running</b> signal generation in the <b>Armed Auto</b> and <b>Armed Retrigger</b> trigger modes.</p> <p>Signal generation can be restarted by a new trigger (internally with <b>Execute Trigger</b> or externally).</p> <p>Remote-control command: SOUR:BB:TDSC:TRIG:ARM:EXEC</p>

**Execute Trigger - TD-SCDMA**

Executes trigger manually. A manual trigger can be executed only when an internal trigger source and a trigger mode other than Auto have been selected.

Remote-control commands:

```
SOUR:BB:TDSC:TRIG:SOUR INT
SOUR:BB:TDSC:SEQ RETR
SOUR:BB:TDSC:TRIG:EXEC
```

**Trigger Source - TD-SCDMA**

Selects trigger source. This setting is effective only when a trigger mode other than Auto has been selected.

**Internal**

The trigger event is executed by **Execute Trigger**.

Remote-control command:

```
SOUR:BB:TDSC:TRIG:SOUR INT
```

**Internal (Baseband B)**

The trigger event is executed by the trigger signal from the second path (two-path instruments only).

Remote-control command:

```
SOUR:BB:TDSC:TRIG:SOUR OBAS
```

**External (TRIGGER 1 / 2)**

The trigger event is executed with the aid of the active edge of an external trigger signal. The trigger signal is supplied via the TRIGGER 1 or TRIGGER 2 connector.

The polarity, the trigger threshold, and the input impedance of the TRIGGER input can be set in the **Global Trigger/Clock Settings** menu.

Remote-control command:

```
SOUR:BB:TDSC:TRIG:SOUR EXT|BEXT
```

**Trigger Delay - TD-SCDMA**

Sets the trigger signal delay in chips on external triggering or on internal triggering via the second path.

This enables the R&S Vector Signal Generator to be synchronized with the device under test or other external devices.

**Note:**

*The delay can be set separately for each of the two paths.*

Remote-control command:

```
SOUR:BB:TDSC:TRIG:EXT:DEL 3
SOUR:BB:TDSC:TRIG:OBAS:DEL 3
```



**Trigger Inhibit - TD-SCDMA** Sets the duration for inhibiting a new trigger event subsequent to triggering. The input is to be expressed in chips.

In the **Retrigger** mode, every trigger signal causes signal generation to restart. This restart is inhibited for the specified number of samples.

This parameter is only available on external triggering or on internal triggering via the second path.

---

**Note:**

*The trigger inhibit can be set separately for each of the two paths.*

---

Remote-control command:

SOUR:BB:TDSC:TRIG:EXT1:INH 1000

SOUR:BB:TDSC:TRIG:OBAS:INH 1000

The marker output signal for synchronizing external instruments is configured in the **Marker Settings** section **Marker Mode**.

**Marker Mode - TD-SCDMA** Selects a marker signal for the associated MARKER output.

Marker 1	Chip Sequence Period (ARB)
Marker 2	Radio Frame
Marker 3	Chip Sequence Period (ARB)
Marker 3	System Frame Number (SFN) Restart
Marker 3	User Period
Marker 4	On/Off Ratio

**Radio Frame** A marker signal is generated every 10 ms (traffic channel frame clock).

Remote-control command:

SOUR:BB:TDSC:TRIG:OUTP1:MODE RFR

**Chip Sequence Period (ARB)** A marker signal is generated at the beginning of every arbitrary waveform sequence (depending on the set sequence length). The marker signal is generated regardless of whether or not an ARB component is actually used.

Remote-control command:

SOUR:BB:TDSC:TRIG:OUTP1:MODE CSP

**System Frame Number (SFN) Restart** A marker signal is generated at the start of every SFN period (every 4096 frames).

Remote-control command:

SOUR:BB:TDSC:TRIG:OUTP1:MODE SFNR

**On/Off Ratio**

A regular marker signal that is defined by an ON/OFF ratio is generated. A period lasts one ON and OFF cycle.

Start of signal

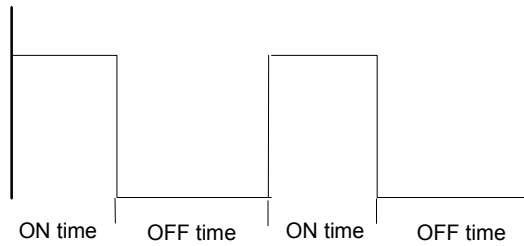

The ON time and OFF time are each expressed as a number of chips and are set in an input field which opens when **On/Off Ratio** is selected.

On Time  Chips   
 Off Time  Chips

Remote-control commands:

```
SOUR:BB:TDSC:TRIG:OUTP1:MODE RAT
SOUR:BB:TDSC:TRIG:OUTP1:OFFT 200
SOUR:BB:TDSC:TRIG:OUTP1:ONT 200
```

**User Period**

A marker signal is generated at the beginning of every user-defined period. The period is defined in **Period**.

Period  Chips

Remote-control command:

```
SOUR:BB:TDSC:TRIG:OUTP1:MODE USER
SOUR:BB:TDSC:TRIG:OUTP1:PER 614400
```

The **Marker Delay** section can be used to set a delay for the markers.

**Marker Delay <n> - TD-SCDMA**

Enters the delay between the marker signal at the marker outputs and the start of the signal. The value range is  $0 \dots 2^{32} - 1$  chips

The input is expressed as a number of chips.

If the setting "**Fix Marker Delay to Current range**" is enabled, the setting range is restricted to the dynamic range. In this range, the delay of the marker signals can be set without restarting the marker and signal.

Remote-control command:

```
SOUR:BB:TDSC:TRIG:OUTP2:DEL 2
```

**Current Range without Recalculation- TD-SCDMA** Displays the current range within which the delay of the marker signals can be set without restarting the marker and signal.

Remote-control command:

SOUR:BB:TDSC:TRIG:OUTP2:DEL:MAX?

SOUR:BB:TDSC:TRIG:OUTP2:DEL:MIN?

**Fix Marker Delay To Current Range - TD-SCDMA** Restricts the marker delay setting range to the current range. In this range, the delay can be set without restarting the marker and signal.

Remote-control command:

SOUR:BB:TDSC:TRIG:OUTP:DEL:FIX ON

The clock source is selected in the **Clock Settings** section.

**Clock Source - TD-SCDMA** Selects the clock source.

**Internal** The internal clock reference is used to generate the chip clock.

Remote-control command:

SOUR:BB:TDSC:CLOC:SOUR INT

**External** The external clock reference is fed in as the chip clock or multiple thereof via the CLOCK connector.

The chip rate must be correctly set to an accuracy of  $\pm 2\%$  (see data sheet).

The polarity of the clock input can be changed with the aid of **Global Trigger/Clock Settings**.

Remote-control command:

SOUR:BB:TDSC:CLOC:SOUR EXT

**Clock Mode - TD-SCDMA** (This feature is available for the external clock source only.)

Selects the type of externally supplied clock.

**Chip** A chip clock is supplied via the CLOCK connector.

Remote-control command:

SOUR:BB:TDSC:CLOC:MODE CHIP

**Multiple Chip** A multiple of the chip clock is supplied via the CLOCK connector. The chip clock is derived internally from this. The value range is 1 to 64.

The **Chip Clock Multiplier** field provided allows the multiplication factor to be entered.

Remote-control command:

SOUR:TDSC:CLOC:MODE MCH

**Chip Clock Multiplier - TD-SCDMA**

**(This feature is available for the external clock source only.)**

Enters the multiplication factor for clock type **Multiple Chip**.

Remote-control command:  
SOUR:BB:TDSC:CLOC:MULT 4

**Measured External Clock - TD-SCDMA**

**(This feature is available for the external clock source only.)**

Displays the measured frequency of the external clock signal. This enables the user to permanently monitor the frequency of the externally introduced clock.

This information is displayed only if the external clock source has been selected.

Remote-control command:  
CLOC:INP:FREQ?

**Global Trigger/Clock Settings - TD-SCDMA**

Calls the **Global Trigger/Clock/Input Settings** menu. This menu is used among other things for setting the trigger threshold, the input impedance and the polarity of the trigger inputs TRIGGER 1/2.

In the case of two-path instruments these settings are valid for both paths.

The parameters in this menu affect all digital modulations and standards, and are described in the section "[Global Trigger/Clock/Input Settings – Setup -Environment](#)".

**User Marker/AUX I/O Settings – TD-SCDMA**

Calls the **UserMarker/AUX I/O** menu. This menu is used for mapping configuration.

The parameters in this menu affect all digital modulations and standards, and are described in the section "[Global Trigger/Clock/Input Settings – Setup -Environment](#)".

## Predefined Settings - TD-SCDMA

The **Predefined Settings** menu is reached via the **TD-SCDMA** main menu. The channel table of cell 1 is filled (preset) with the set parameters.

With the **Predefined Settings** function, it is possible to create highly complex scenarios with just a few keystrokes. This function is of use if, say, just the envelope of the signal is of interest. The settings provided depend on the link direction and applies only to cell1.

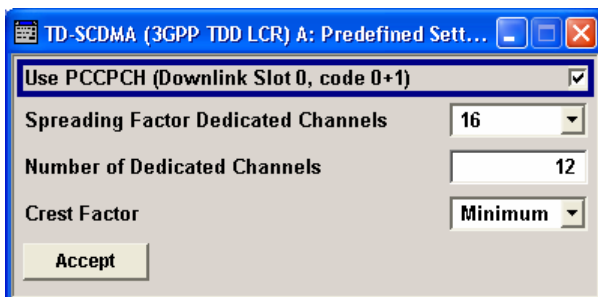

**Use PCCPCH (Downlink Slot 0, code 0+1) - TD-SCDMA****(This feature is available in the downlink only.)**

Selects, if P-CCPCH is used in the scenario or not.

If P-CCPCH is used, both P-CCPCHs are activated in slot 0 with spreading code 0+1.

Remote-control command:

SOUR:BB:TDSC:DOWN:PPAR:PCCP:STAT ON

**Spreading Factor Dedicated Channels - TD-SCDMA**

Selects the spreading factor for the DPCHs.

The available spreading factors depend on the link direction.

Remote-control command:

SOUR:BB:TDSC:DOWN:PPAR:DPCH:SFAC 16

**Number of Dedicated Channels - TD-SCDMA**

Sets the number of activated DPCHs.

The minimum number is 1 and the maximum number depends on the spreading factor:

Max. No. DPCH = 3 x Spreading Factor

Remote-control command:

SOUR:BB:TDSC:DOWN:PPAR:DPCH:COUN 48

**Crest Factor - TD-SCDMA**

Selects the desired range for the crest factor scenario.

The crest factor of the signal is kept in the desired range by varying the distribution of the channels inside one slot and in between several slots.

**Minimum**

The crest factor is minimized. The channels are distributed uniformly over the slots and over the code domain of the individual slot.

Remote-control command:

SOUR:BB:TDSC:DOWN:PPAR:DPCH:CRES MIN

**Average**

An average crest factor is set. The channel are distributed uniformly over the slots and successively in the code domain of the individual slot.

Remote-control command:

SOUR:BB:TDSC:DOWN:PPAR:DPCH:CRES AVER

**Worst**

The crest factor is set to an unfavorable value (i.e. maximum). The channels are distributed in clusters over the slots and successively in the code domain of the individual slot.

Remote-control command:

SOUR:BB:TDSC:DOWN:PPAR:DPCH:CRES WORS

**Accept - TD-SCDMA**

Presets the channel table of cell 1 with the parameters defined in the **Predefined Settings** menu.

Remote-control command:  
 SOUR:BB:TDSC:DOWN:PPAR:EXEC

## Cell Configuration - TD-SCDMA

The **Cell Configuration** menu is called by selecting **Cell1 ... Cell4** in the **TD-SCDMA** menu. Cells can be configured independently of one another. Cell1 also includes real time channels.

The menu comprises the **Common Settings** section, in which the general parameters of the cell are set and the **Select Slot in Subframe to Configure** section, in which the slots are selected for configuration.

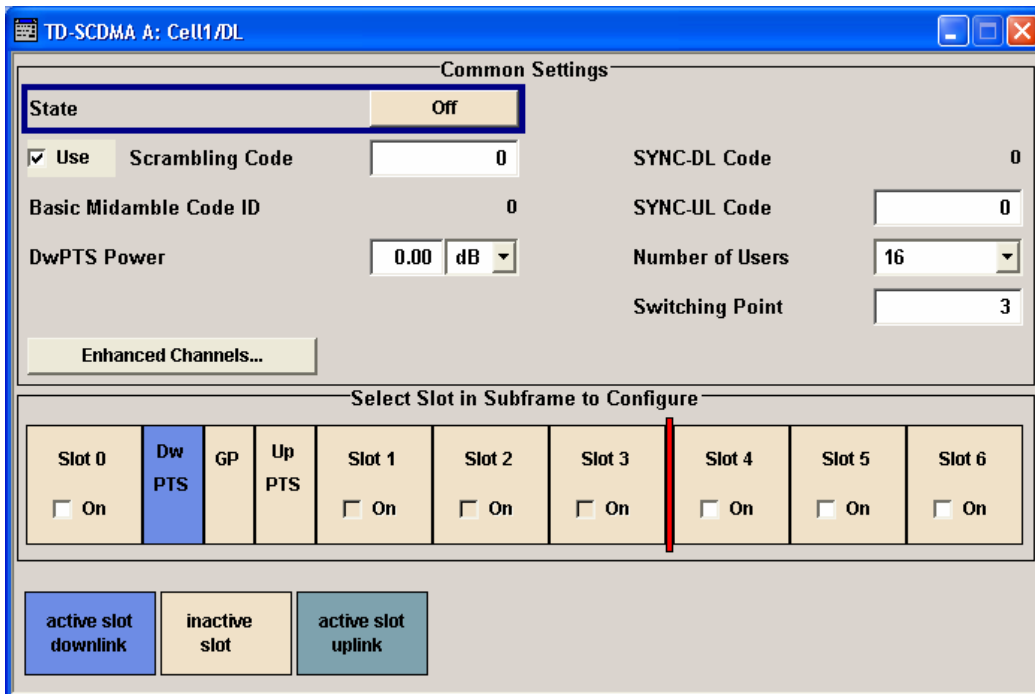

**State - TD-SCDMA**

Activates or deactivates the selected cell.

The number of the selected cell is displayed in the menu header.

Remote-control command:  
 SOUR:BB:TDSC:DOWN:CELL1:STAT ON

<b>Use (Scrambling Code) – TD-SCDMA</b>	<p>Activates or deactivates the scrambling code.</p> <p>The scrambling code is deactivated, for example, for test purposes.</p> <p>Remote-control commands:  SOUR:BB:TDSC:DOWN:CELL1:SCOD:STAT ON</p>
<b>Scrambling Code – TD-SCDMA</b>	<p>Sets the scrambling code. The scrambling code identifies the cell and is the starting value of the scrambling code generator.</p> <p>The scrambling code is used for transmitter-dependent scrambling of the chip sequence. The value range is 0 to 127.</p> <p>Remote-control command:  SOUR:BB:TDSC:DOWN:CELL1:SCOD 4</p>
<b>Basic Midamble Code ID - TD-SCDMA</b>	<p>Displays the basic midamble code ID of the cell.</p> <p>The basic midamble code ID is derived from the scrambling code.</p> <p>emote-control command:  SOUR:BB:TDSC:DOWN:CELL1:MCOD?  Response: 4</p>
<b>DwPTS Power - TD-SCDMA</b>	<p>Sets the power of the downlink pilot time slot.</p> <p>Remote-control command:  SOUR:BB:TDSC:DOWN:CELL1:DWPT:POW -12.5</p>
<b>SYNC-DL Code - TD-SCDMA</b>	<p>Displays the SYNC-DL code.</p> <p>The SYNC-DL code is transmitted in the DwPTS (downlink pilot time slot). It is used by the the user equipment to synchronize to the base station.</p> <p>The SYNC-DL code is derived from the scrambling code and the basic midamble code ID.</p> <p>Remote-control commands:  SOUR:BB:TDSC:DOWN:CELL1:SYND?  Response: 14</p>
<b>SYNC-UL Code - TD-SCDMA</b>	<p>Sets the SYNC-UL code.</p> <p>The SYNC-UL code is transmitted in the UpPTS. It is used by the base station to synchronize to the user equipment.</p> <p>The SYNC-UL code is derived from the scrambling code and the basic midamble code ID.</p> <p>Remote-control commands:  SOUR:BB:TDSC:DOWN:CELL1:SYNU 4</p>

**Number of Users - TD-SCDMA**

Selects the total number of users of the cell. The number of users influences the actual midamble sequence transmitted in the burst.

Remote-control commands:

SOUR:BB:TDSC:DOWN:CELL1:USER 16

**Switching Point - TD-SCDMA**

Sets the switching point between the uplink slots and the downlink slots in the frame.

Slot 0 is always allocated to the downlink, Slot 1 is allways allocated to the uplink.

In the **Select Slot in Subframe to Configure** section, the switching point in indicated by a red bar. The slots to the left of the red bar are generated for link direction downlink, to the right of the red bar for link direction uplink. Only the slots for one link direction are active at a time, the slots of the other link direction are inactive.

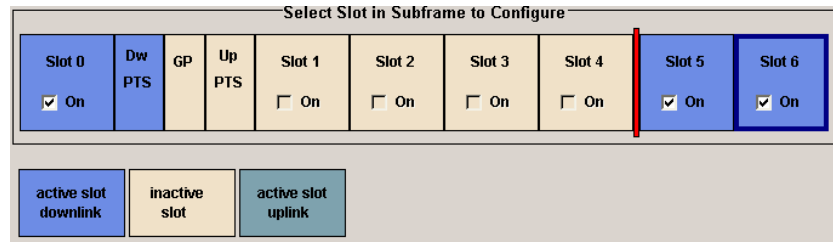

The DwPTS is always active in downlink mode. The UpPTS is only active if PRACH is selected for the uplink slots.

Remote-control commands:

SOUR:BB:TDSC:DOWN:CELL1:SPOI 4

**Enhanced Channels... - TD-SCDMA (This button is available for cell1 only.)**

Calls the menu for setting enhanced channel configurations.

he menu is described in Section "[Enhanced Channels Settings – TD-SCDMA](#), Page 4.773

Remote-control command: n.a.

**Select Slot in Subframe to Configure – TD-SCDMA**

Displays the slots of the cell.

Active slots are highlighted blue (downlink) and green (uplink). Clicking a slot in the subframe opens a menu for configuring the channels of the selected slot.

The menu is described in Section [Slot Configuration – TD-SCDMA](#), Page 4.782.

Remote-command: n.a.

**Slot Icon - TD-SCDMA**

Activates or deactivates the slot in the subframe.

Remote-command :

SOUR:BB:TDSC:DOWN:CELL1:SLOT0:STAT ON



## Enhanced Channels Settings – TD-SCDMA

The **Enhanced Channels Settings** menu is called in the **Cell Configuration** menu with button **Enhanced Channels...**

**This menu is only available for cell 1.**

The layout of the **Enhanced Channels Settings** menu depends on the transmission direction. For downlink/forward direction, the Broadcast Channels (BCH) section is provided. All other sections are offered for both link directions.

TD-SCDMA A: Enhanced Channels Settings 1/DL

**Broadcast Channels (BCH)**

State: Off

Coding Type: Coded BCH Including SFN

Show Details >>>

Mapping On Physical Channels: BCH mapped to Slot 0, P-CCPCH 1/2

Slot 0	Dw PTS	GP	Up PTS	Slot 1	Slot 2	Slot 3	Slot 4	Slot 5	Slot 6
<input checked="" type="checkbox"/> On				<input type="checkbox"/> On	<input type="checkbox"/> On	<input type="checkbox"/> On	<input type="checkbox"/> On	<input type="checkbox"/> On	<input type="checkbox"/> On

Spreading Code Selection: Auto

The **Broadcast Channels (BCH)** section is where the enhanced state of the channel can be activated.

The detailed **Transport Channel** settings can be revealed with the **Show Details >>>** button and hidden with the **<<<Hide Details** button.

**Dedicated Channels (DCH)**

State: Off

Coding Type: RMC 12.2 kbps

Resource Units On Physical Layer: 1 TS (2 \* SF 16)

Show Details >>>

Mapping On Physical Channels: Select Slots To Use

Slot 0	Dw PTS	GP	Up PTS	Slot 1	Slot 2	Slot 3	Slot 4	Slot 5	Slot 6
<input type="checkbox"/> On				<input type="checkbox"/> On	<input type="checkbox"/> On	<input type="checkbox"/> On	<input checked="" type="checkbox"/> On	<input type="checkbox"/> On	<input type="checkbox"/> On

Spreading Code Selection For Used DPCHs: Auto

The **Dedicated Channels (DCH)** section is where the enhanced state of the channel can be activated and settings can be made.

The detailed **Transport Channel** settings can be revealed with the **Show Details >>>** button and hidden with the **<<<Hide Details** button.

**Bit Error Insertion**

State:  On

Bit Error Rate: 0.001 000 0

Insert Errors On: Transport Layer

The **Bit Error Insertion** section is where the bit error simulation is configured and activated.

**Block Error Insertion**

State:  On

Block Error Rate: 0.100 0

The **Block Error Insertion** section is where the block error simulation is configured and activated.

The **Broadcast Channels (BCH)** section is where the enhanced state of the channel can be activated.

**This section is only available for downlink/forward transmission direction.**

**State (BCH) – TD-SCDMA** Activates or deactivates P-CCPCH 1/2 channel coding.

ON: Slot 0 is active with P-CCPCH 1 and 2 switched on. The data source is fixed to BCH.

Remote-control command:

```
SOUR:BB:TDSC:DOWN:CELL1:ENH:BCH:STAT ON
```

**Coding Type (BCH) – TD-SCDMA**

Displays the coding scheme.

The coding scheme of P-CCPCH (BCH) is specified in the standard. The channel is generated automatically with the counting system frame number (SFN). The system information after the SFN field is provided by the selected data source.

Remote-control command:

SOUR:BB:TDSC:DOWN:CELL1:ENH:BCH:TYPE?

**Show Details... - TD-SCDMA**

Reveals the detailed settings options. Once the details are revealed, the labeling on the button changes to **<<<Hide Details**. Clicking the button hides the detailed settings options.

The menu is described in Section [Enhanced Channel Settings – Details – TD-SCDMA](#), Page 4.778.

Remote-control command: n.a.

**Mapping On Physical Channels: BCH mapped to <Slot> 0, P-CCPCH1/2– TD-SCDMA**

Displays the slots of cell 1 used to transmit the broadcast channels. For BCH always slot 0 is used

Remote-control command:

SOUR:BB:TDSC:DOWN:CELL1:ENH:BCH:SLOT 0?

Response: ON

**Spreading Code Selection (BCH) – TD-SCDMA**

Selects if the spreading codes of the channels is set automatically or manually. For BCH, the spreading code is always set to **Auto**. as the spreading code for the P-CCPCH is defined by the standard.

Remote-control command:

SOUR:BB:TDSC:DOWN:CELL1:ENH:BCH:SCSM?

Response: AUTO

In the **Dedicated Channels (DCH)** section, the enhanced state of the channel can be activated and enhanced channel settings can be made.

**State (DCH) – TD-SCDMA**

Activates or deactivates DCH channel coding.

ON

Activates the slots selected in the **Mapping On...** graph below. The number and configuration of the DPCHs is defined by the selected coding type. State and slot format of the channels are preset. The data source is fixed to DCH.

Remote-control command:

SOUR:BB:TDSC:DOWN:CELL1:ENH:DCH:STAT ON

<b>Coding Type – TD-SCDMA</b>	<p>Selects the channel coding.</p> <p>The current TD-SCDMA specification defines 4 reference measurement channel coding types in the uplink and 5+2 measurement channel coding types in the downlink, which differ in the input data bit rate to be processed.</p> <p>The selected coding type defines the number of slots selected in section <b>Mapping On Physical Channels: Select Slots To Use</b>.</p> <p><b>Uplink</b></p> <p>In the uplink, the following measurement channel coding types can be selected:</p> <p>RMC 12.2 kbps: 12.2 kbps measurement channel  RMC 64 kbps: 64 kbps measurement channel  RMC 144 kbps: 144 kbps measurement channel  RMC 384 kbps: 384 kbps measurement channel</p> <p>Remote-control command:  SOUR:BB:TDSC:UP:CELL1:ENH:DCH:TYPE UP_RMC12K2</p> <hr/> <p><b>Note:</b>  <i>If RMC12K2, RMC64K, RMC144K, or RMC384K are selected for the uplink, they are automatically converted to UP_RMCxxx.</i></p> <hr/> <p><b>Downlink</b></p> <p>In the downlink, the following measurement channel coding types can be selected:</p> <p>RMC 12.2 kbps: 12.2 kbps measurement channel  RMC 64 kbps: 64 kbps measurement channel  RMC 144 kbps: 144 kbps measurement channel  RMC 384 kbps: 384 kbps measurement channel  RMC 2048 kbps: 2048 kbps measurement channel  H-RMC 526 kbps: 526 kbps HSDPA measurement channel  H-RMC 730 kbps: 730 kbps HSDPA measurement channel</p> <p>Remote-control command:  SOUR:BB:TDSC:DOWN:CELL1:ENH:DCH:TYPE RMC12K2</p>
<b>Resource Units On Physical Layer – TD-SCDMA</b>	<p>Displays the resource units on the physical layer needed to generate the selected channel.</p> <p>Remote-control command:  SOUR:BB:TDSC:DOWN:CELL1:ENH:DCH:RUPL?</p>
<b>Show Details...</b>	<p>Reveals the detailed settings options. Once the details are revealed, the labeling on the button changes to <b>&lt;&lt;&lt;Hide Details</b>. Clicking the button hides the detailed settings options.</p> <p>The menu is described in Section <a href="#">Enhanced Channel Settings – Details – TD-SCDMA</a>, Page 4.778.</p> <p>Remote-control command: n.a.</p>

**Mapping On Physical Channels: Select Slots To Use – TD-SCDMA**

Displays the slots of cell 1. The slots used to transmit the transport channel are highlighted.

The number selected slots is determined by the selected coding type. If a slot is deactivated, another slot is activated automatically to keep the number of activated slots unchanged.

Remote-control command:

```
SOUR:BB:TDSC:DOWN:CELL1:ENH:DCH:SLOT4 ON
```

**Spreading Code Selection For Used DPCHs – TD-SCDMA**

Selects the spreading code selection mode for the used transport channels.

**User**

The spreading codes can be set manually.

Remote-control command:

```
SOUR:BB:TDSC:DOWN:CELL1:ENH:DCH:SCSM
USER
```

**Auto**

The spreading codes are distributed evenly over the slot domains in order to ensure the minimum crest factor.

Remote-control command:

```
SOUR:BB:TDSC:DOWN:CELL1:ENH:DCH:SCSM
AUTO
```

In the **Bit Error Insertion** section, the bit error simulation is configured and activated.

**State – TD-SCDMA (Bit Error)**

Activates or deactivates bit error generation.

Bit errors are inserted into the data fields of the enhanced channels. If channel coding is active, it is possible to select the layer in which the errors are inserted (physical or transport layer).

When the data source is read out, individual bits are deliberately inverted at random points in the data bit stream at the specified error rate in order to simulate an invalid signal.

Remote-control command:

```
SOUR:BB:TDSC:DOWN:CELL1:ENH:DCH:BIT:STAT ON
```

**Bit Error Rate – TD-SCDMA**

Enters the bit error rate.

Remote-control command:

```
SOUR:BB:TDSC:DOWN:CELL1:ENH:DCH:BIT:RATE 1e-2
```

**Insert Errors On – TD-SCDMA**

Selects the layer in the coding process at which bit errors are inserted.

**Transport Layer** Bit errors are inserted in the transport layer.

This selection is only available if channel coding is active.

Remote-control command:

```
SOUR:BB:TDSC:DOWN:CELL1:ENH:DCH:BIT:L  
AY TRAN
```

**Physical Layer** Bit errors are inserted in the physical layer.

Remote-control command:

```
SOUR:BB:TDSC:DOWN:CELL1:ENH:DCH:BIT:L  
AY PHYS
```

In the **Block Error Insertion** section, the block error simulation is configured and activated.

**State – TD-SCDMA (Block Error)**

Activates or deactivates block error generation.

The CRC checksum is determined and then the last bit is inverted at the specified error probability in order to simulate an invalid signal.

Remote-control command:

```
SOUR:BB:TDSC:DOWN:CELL1:ENH:DCH:BLOC:STAT ON
```

**Block Error Rate – TD-SCDMA**

Enters the block error rate.

Remote-control command:

```
SOUR:BB:TDSC:DOWN:CELL1:ENH:DCH:BLOC:RATE 1e-2
```

## Enhanced Channel Settings – Details – TD-SCDMA

<b>Slot Format – TD-SCDMA</b>	<p>Displays the slot format of the selected channel.</p> <p>A slot format defines the complete structure of a slot made of data and control fields. The slot format depends on the coding type selected.</p> <p>Remote-control command:  SOUR:BB:TDSC:DOWN:CELL1:ENH:BCH:SFOR?  SOUR:BB:TDSC:UP:CELL1:ENH:DCH:SFOR?</p>
<b>Data Bits Per Frame (10 ms) – TD-SCDMA</b>	<p>Displays the data bits in the DPDCH component of the DPCH frame at physical level. The value depends on the slot format.</p> <p>Remote-control command:  SOUR:BB:TDSC:DOWN:CELL1:ENH:BCH:BPFR?    SOUR:BB:TDSC:UP:CELL1:ENH:DCH:BPFR?</p>
<b>Redundancy Version Parameter – TD-SCDMA</b>	<p>Sets the redundancy version parameter. This parameter indicates which redundancy version of the data is sent.</p> <p>Remote-control command:  SOUR:BB:TDSC:UP:CELL1:ENH:DCH:HSCH:RVP 3</p>
<b>Priorisation Of Systematic Bits - s</b>	<p>Displays the priorisation of systematic bits – s. This value depends on the redundancy version parameter.</p> <p>Remote-control command:  SOUR:BB:TDSC:DOWN:CELL1:ENH:DCH:HSCH:PSBS?    Response: 0</p>
<b>Puncturing And Repetition Scheme - r</b>	<p>Displays the puncturing and repetition scheme - r. This value depends on the redundancy version parameter.</p> <p>Remote-control command:  SOUR:BB:TDSC:DOWN:CELL1:ENH:DCH:HSCH:PRSR?    Response: 1</p>
<b>Constellation Version Parameter - b</b>	<p>Displays the constellation version parameter - b. This value depends on the redundancy version parameter.</p> <p>Remote-control command:  SOUR:BB:TDSC:DOWN:CELL1:ENH:DCH:HSCH:CVPB?    Response: 1</p>

In the **Transport Channel** section, the transport channels (TCHs) can be configured. The most important parameters of the TCH are displayed (transport block size and data source). The associated parameters shown in the section below depend on which TCH is currently selected. A wide arrow beneath the block indicates which TCH is currently selected.

### DTCH On/DCCH On – TD-SCDMA

Displays the transport channel state.

---

**Note:**

*For BCH, only the DTCH component is active.*

---

Remote-control command:

SOUR:BB:TDSC:DOWN:CELL1:ENH:BCH:DTCH:STAT?

SOUR:BB:TDSC:UP:CELL1:ENH:DCH:DTCH:STAT?

### Data Source – TD-SCDMA

Selects the data source for the transport channel.

The following are available for selection as data sources:

#### All 0

0 data and 1 data is generated internally.

#### All 1

Remote-control command:

SOUR:BB:TDSC:DOWN:CELL1:ENH:BCH:DTCH:

DATA ZERO | ONE

SOUR:BB:TDSC:DOWN:CELL1:ENH:DCH:DTCH:

DATA ZERO | ONE

#### PN xx

PRBS data as per CCITT with period lengths between  $2^9-1$  and  $2^{23}-1$  is generated internally.

Remote-control command:

SOUR:BB:TDSC:DOWN:CELL1:ENH:BCH:DTCH:

DATA PN9 | PN11 | 15 | 16 | 20 | 21 |

23

#### Pattern

A user-definable bit pattern with a maximum length of 64 bits is generated internally.

The bit pattern is defined in the **Pattern** entry field.

Remote-control command:

SOUR:BB:TDSC:DOWN:CELL1:ENH:BCH:DTCH:

DATA PATT

SOUR:BB:TDSC:DOWN:CELL1:ENH:BCH:DTCH:

DATA:PATT #H3F,8

SOUR:BB:TDSC:DOWN:CELL1:ENH:DCH:DTCH:

DATA PATT

SOUR:BB:TDSC:DOWN:CELL1:ENH:DCH:DTCH:

DATA:PATT #H3F,8

<b>Data List</b>	<p>Internal data from a programmable data list is used. The data list can be generated by the Data Editor or generated externally.</p> <p>Data lists are selected in the <b>Select Data List</b> field.</p> <p>Remote-control command:  SOUR:BB:TDSC:DOWN:CELL1:ENH:BCH:DTCH:  DATA DLIS  SOUR:BB:TDSC:DOWN:CELL1:ENH:BCH:DTCH:  DATA:DSEL "tdscdma_1"</p> <p>SOUR:BB:TDSC:DOWN:CELL1:ENH:DCH:DTCH:  DATA DLIS  SOUR:BB:TDSC:DOWN:CELL1:ENH:DCH:DTCH:  DATA:DSEL "tdscdma_1"</p>
<b>Transport Time Interval – TD-SCDMA</b>	<p>Displays the number of frames into which a TCH is divided. This setting also defines the interleaver depth.</p> <p>Remote-control command:  SOUR:BB:TDSC:DOWN:CELL1:ENH:BCH:DTCH:TTIN?  Response: 20ms</p> <p>SOUR:BB:TDSC:DOWN:CELL1:ENH:DCH:DTCH:TTIN?  Response: 20ms</p>
<b>Transport Blocks – TD-SCDMA</b>	<p>Displays the number of transport blocks for the TCH.</p> <p>Remote-control command:  SOUR:BB:TDSC:DOWN:CELL1:ENH:BCH:DCCH:TBC?  Response: 1  SOUR:BB:TDSC:DOWN:CELL1:ENH:DCH:DCCH:TBC?  Response: 1</p>
<b>Transport Block Size – TD-SCDMA</b>	<p>Displays the size of the transport block at the channel coding input.</p> <p>Remote-control commands:  SOUR:BB:TDSC:DOWN:CELL1:ENH:BCH:DTCH:TBS?  Response: 24  SOUR:BB:TDSC:DOWN:CELL1:ENH:DCH:DTCH:TBS?  Response: 24</p>
<b>Size Of CRC – TD-SCDMA</b>	<p>Displays the type (length) of the CRC.</p> <p>Remote-control commands:  SOUR:BB:TDSC:DOWN:CELL1:ENH:BCH:DTCH:CRCS?  Response: 16  SOUR:BB:TDSC:DOWN:CELL1:ENH:DCH:DTCH:CRCS?  Response: 16</p>



<b>Rate Matching Attribute – TD-SCDMA</b>	<p>Displays the rate matching.</p> <p>Remote-control commands:  SOUR:BB:TDSC:DOWN:CELL1:ENH:BCH:DTCH:RMAT?  <b>Response:</b> 256  SOUR:BB:TDSC:DOWN:CELL1:ENH:DCH:DTCH:RMAT?  <b>Response:</b> 256</p>
<b>Error Protection – TD-SCDMA</b>	<p>Displays the error protection.</p> <p>Remote-control commands:  SOUR:BB:TDSC:DOWN:CELL1:ENH:BCH:DTCH:EPR?  <b>Response:</b> CON3  SOUR:BB:TDSC:DOWN:CELL1:ENH:DCH:DTCH:EPR?  <b>Response:</b> CON3</p>
<b>Interleaver 1 State – TD-SCDMA</b>	<p>Activates or deactivates the channel coding interleaver state 1 of the transport channel. Interleaver state 1 can be set independently in each TCH. Activation does not change the symbol rate.</p> <p>Remote-control commands:  SOUR:BB:TDSC:DOWN:CELL1:ENH:BCH:DTCH:INTO ON  SOUR:BB:TDSC:DOWN:CELL1:ENH:DCH:DTCH:INTO ON</p>
<b>Interleaver 2 State – TD-SCDMA</b>	<p>Activates or deactivates the channel coding interleaver state 2 off all the transport channels. Interleaver state 2 can only be set for all the TCHs together. Activation does not change the symbol rate.</p> <p>Remote-control commands:  SOUR:BB:TDSC:DOWN:CELL1:ENH:BCH:DTCH:INTT ON  SOUR:BB:TDSC:DOWN:CELL1:ENH:DCH:DTCH:INTT ON</p>

## Slot Configuration – TD-SCDMA

The **Slot Configuration** menu is called by selecting the respective slot in the **Cell Configuration** menu. The most important part of the menu is the channel table with graphical display of the structure of the channel being edited.

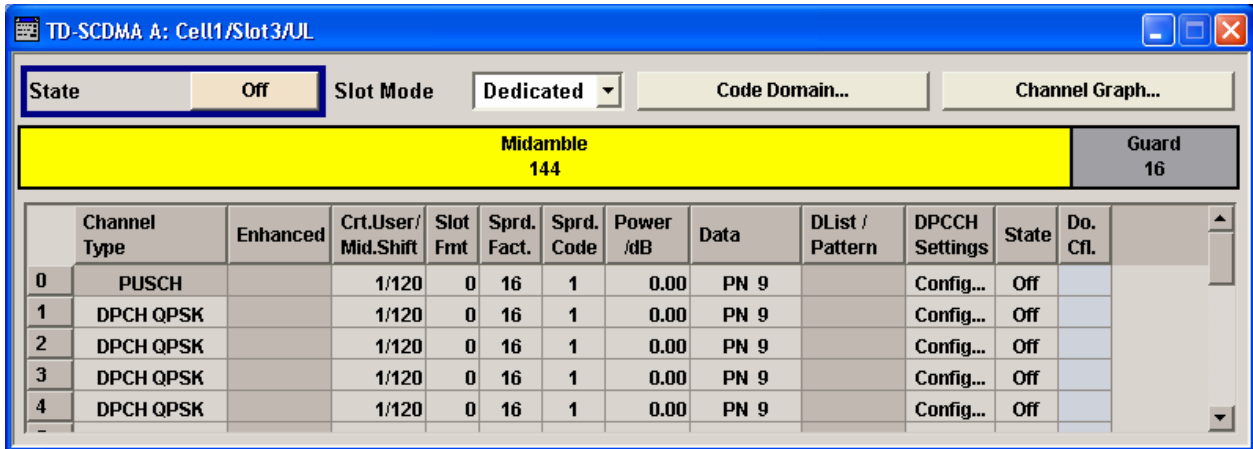

### State – TD-SCDMA

Activates or deactivates the selected slot. The index of the selected slot is displayed in the menu header.

Remote-control command:

```
SOUR:BB:TDSC:UP:CELL1:SLOT3:STAT ON
```

### Slot Mode – TD-SCDMA

**(This feature is available in the uplink only.)**

Selects the slot mode.

**Dedicated** Selects the Dedicated mode. In this mode, the instrument generates a signal with a dedicated physical control channel (DPCCH) and up to 6 dedicated physical data channels (DPDCH). The signal is used for voice and data transmission.

Remote-control command:

```
SOUR:BB:TDSC:UP:CELL1:SLOT3:MODE DED
```

**PRACH** In this mode, the instrument generates a single physical random access channel (PRACH). This channel is needed to set up the connection between the mobile and the base station. All the PRACH parameters can be set in the **PRACH Settings** section (see Section [Slot Mode PRACH Settings – TD-SCDMA](#), Page 4.791).

Remote-control command:

```
SOUR:BB:TDSC:UP:CELL1:SLOT3:MODE PRAC
```

<b>Code Domain... - TD-SCDMA</b>	<p>Opens the code domain display to visually check the code domain.</p> <p>The display is described in Section <a href="#">Code Domain – TD-SCDMA</a>, Page 4.794.</p> <p>Remote-control command: n.a.</p>
<b>Channel Graph... - TD-SCDMA</b>	<p>Opens the channel graph display to visually check the configured signal.</p> <p>The display is described in Section <a href="#">Channel Graph – TD-SCDMA</a>, Page 4.795.</p> <p>Remote-control command: n.a</p>

## Channel Table – TD-SCDMA

The **channel table** is located in the lower part of the **Slot Configuration** menu. The channel table is where the individual channel parameters are set. The structure of the channel currently being edited is displayed graphically in the table header.

The number of channels and the available channel types depend on the link direction (see below "[Channel Type – TD-SCDMA](#)"). In downlink, Channels 0 to 5 are assigned to the special channels, with the allocation of the channels being fixed. In uplink, Channels 0 is assigned to a special channel, with the allocation of the channel being fixed. It is possible to simulate the signal of a base station that supports high speed channels.

<b>Channel Number – TD-SCDMA</b>	<p>Displays the consecutive channel numbers. The range depends on the selected transmission direction.</p> <p>All available channels are displayed, even those that are inactive. Each channel is activated/deactivated by the <b>State</b> button.</p> <p>Remote-control command: n.a . (selected via the suffix to the keyword : CHANnel &lt;n&gt;)</p>
----------------------------------	---

<b>Channel Type – TD-SCDMA</b>	<p>Selects the channel type.</p> <p>In the uplink, the channel type is fixed for channel number 0.</p> <p>In the downlink, the channel type is fixed for channel numbers 0 to 5.</p> <p>For the remaining numbers, the choice lies between the relevant standard channels and the high speed channels (see table below).</p> <p>Remote-control command: SOUR:BB:TDSC:DOWN:CELL1:SLOT0:CHAN3:TYPE S_CCPCH1</p>
--------------------------------	---

Table 4-32 List of supported channel types and their sequence in the TD-SCDMA channel table

**For Downlink:**

Index	Shortform	Name	Function
0	P-CCPCH 1	Primary Common Control Phys. Channel 1	Transfers the system frame number (SFN) Timing reference for additional downlink channels Contains the BCH transport channel
1	P-CCPCH 2	Primary Common Control Phys. Channel 2	Transfers the system frame number (SFN) Timing reference for additional downlink channels Contains the BCH transport channel
2	S-CCPCH 1	Secondary Common Control Phys. Channel	
3	S-CCPCH 2	Secondary Common Control Phys. Channel	
4	FPACH	Fast Physical Access Channel	
5	PDSCH	Phys. Downlink Shared Channel	
6-21	DPCH QPSK	Dedicated Phys. Channel Modulation QPSK	Transfers the user data and the control information
	DPCH 8PSK	Dedicated Phys. Channel Modulation 8PSK	
	HS-SCCH 1	High Speed Shared Control Channel 1	
	HS-SCCH 2	High Speed Shared Control Channel 2	
	HS-PDSCH (QPSK)	High Speed Phys. Downlink Shared Channel QPSK	
	HS-PDSCH (16 QAM)	High Speed Phys. Downlink Shared Channel 16 QAM	

**For Uplink:**

Index	Shortform	Name	Function
0	PUSCH	Phys. Uplink Shared Channel	
1-16	DPCH QPSK	Dedicated Phys. Channel Modulation QPSK	
	DPCH 8PSK	Dedicated Phys. Channel Modulation 8PSK	

**Enhanced – TD-SCDMA**

Displays the enhanced state. If the enhanced state is set to ON, the channel coding cannot be changed.

Remote-control command

SOUR:BB:TDSC:UP:CELL1:SLOT1:CHAN6:ENH?

**Crt.User/Mid.Shift – TD-SCDMA**

Enters the value for the user and displays the midamble shift.

Remote-control command:

SOUR:BB:TDSC:DOWN:CELL1:SLOT0:CHAN6:USER 3

**Slot Fmt – TD-SCDMA**

Enters the slot format for the selected channel.

The range of the values depends on the channel selected. For DPCH 8PSK channels, for example, the value range for the slot formats is 0 to 24.

A slot format defines the complete structure of a slot made of data and control fields and includes the symbol rate.

Parameters set via the slot format can subsequently be changed individually.

The structure of the channel currently selected is displayed in a graphic above the channel table.

Remote-control command:

SOUR:BB:TDSC:DOWN:CELL1:SLOT0:CHAN6:SFOR 15

**Sprd. Fact. – TD-SCDMA**

Enters the spreading factor for the selected channel. The selection depends on the channel type and interacts with the slot format.

Remote-control command:

SOUR:BB:TDSC:DOWN:CELL1:SLOT0:CHAN4:SFAC16

**Sprd. Code – TD-SCDMA**

Enters the spreading code for the selected channel. The code channel is spread with the set spreading code. The range of values for the spreading code depends on the channel type and the spreading factor. Depending on the channel type, the range of values can be limited.

Remote-control command:

SOUR:BB:TDSC:DOWN:CELL1:SLOT0:CHAN6:SCOD16

**Power/dB – TD-SCDMA**

Sets the channel power in dB.

The power entered is relative to the powers outputs of the other channels. If **Adjust Total Power to 0 dB** is executed (top level of the TD-SCDMA menu), all the power data is relative to 0 dB.

The value range is -80 dB to 0 dB.

**Note:**

*The maximum channel power of 0 dB applies to non-blanked channels (duty cycle 100%), with blanked channels, the maximum value can be increased (by Adjust Total Power) to values greater*

*than 0 dB (to  $10 * \log_{10} \frac{1}{duty\_cycle}$ ).*

Remote-control command:

SOUR:BB:TDSC:DOWN:CELL1:SLOT0:CHAN6:POW -20

**Data – TD-SCDMA**

Selects data source.

The data sources **PN9**, **PN11**, **PN15**, **PN16**, **PN20**, **PN21**, **PN23**, **ALL0**, **ALL1**, **Pattern** and **Data List** are available to choose from.

If the **Pattern** data type is used, the bit pattern can be entered in a bit editor that is called in the column **DList/Pattern**. The length is limited to 64 bits.

If the **Data List** data type is used, the list can be selected from a file window that is called in the **DList/Pattern** column. The selected data list is shown in the **DList/Pattern** column.

Remote-control commands:

```
SOUR:BB:TDSC:DOWN:CELL1:SLOT0:CHAN6:DATA PN9
```

```
SOUR:BB:TDSC:DOWN:CELL1:SLOT0:CHAN6:DATA PATT
```

```
SOUR:BB:TDSC:DOWN:CELL1:SLOT0:CHAN6:DATA:PATT #H3F,
8
```

```
SOUR:BB:TDSC:DOWN:CELL1:SLOT0:CHAN6:DATA DLIS
```

```
SOUR:BB:TDSC:DOWN:CELL1:SLOT0:CHAN6:DATA:DSEL
"BST_3GPP"
```

**DList/Pattern – TD-SCDMA**

Only active, if data source pattern or data list is selected.

For data source **Pattern**, a user-definable bit pattern can be entered in the **Pattern** entry field.

For data source **Data List**, a data list can be selected.

Remote-control commands:

```
SOUR:BB:TDSC:DOWN:CELL1:SLOT0:CHAN6:DATA:PATT #H3F,
8
```

```
SOUR:BB:TDSC:DOWN:CELL1:SLOT0:CHAN6:DATA:DSEL
"BST_3GPP"
```

**DPCCH Settings – TD-SCDMA**

Calls the menu for configuring the control fields of the selected channel.

The selected slot format predetermines the setting of the control fields.

So a change is also made to the control fields by changing the slot format and vice versa.

The menu is described in Section "[DPCCH Settings – TD-SCDMA](#)", page 4.787.

Remote-control commands: n.a.

**State – TD-SCDMA**

Activates or deactivates the channel.

Remote-control command:

```
SOUR:BB:TDSC:DOWN:CELL1:SLOT3:CHAN5:STAT ON
```

**Do. Cfl. – TD-SCDMA**

Displays whether the channel has a code domain conflict with one of the channels lying above it (with a lower channel number). If there is a conflict, a red dot appears and the column is colored soft orange. If there is no conflict, the column is colored soft blue.

The R&S Vector Signal Generator helps to resolve code domain conflicts. You get the button required for this purpose by clicking the table field in a submenu.

The graphical display of the code domain occupancy by all the active code channels can be called by clicking the **Code Domain** button (see also Section *Code Domain – TD-SCDMA*, page 4.794).

Remote-control command:

SOUR:BB:TDSC:DOWN:CELL1:SLOT1:DCON?

Response: ON

## DPCCH Settings – TD-SCDMA

The **Config DPCCH** menu for configuring the fields of the dedicated physical controller can be called in the channel table in column **DPCCH Settings** with the **Config...** button.

The selected slot format predetermines the setting of the parameter provided in the menu. Whenever the TFCI State and Pilot Length settings are changed, the slot format is adjusted accordingly. Pilot Length and TFCI State can be selected for the S-CCPCH channel.

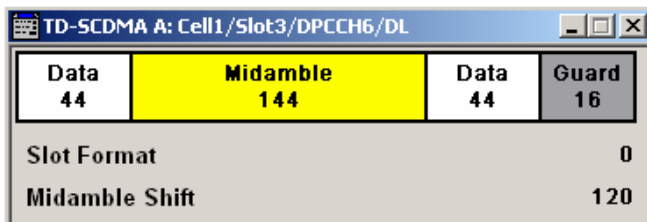

The upper section of the menu is where the slot structure and slot information is displayed.

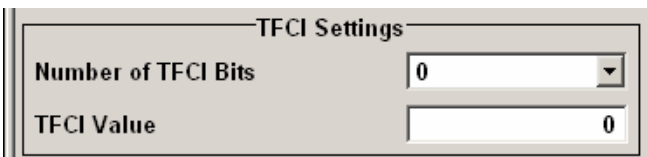

The **TFCI Settings** section is where the TFCI length and value are set.

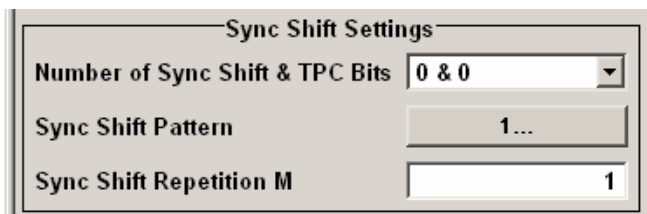

The **Sync Shift Settings** section is where the settings regarding the Sync Shift are set.

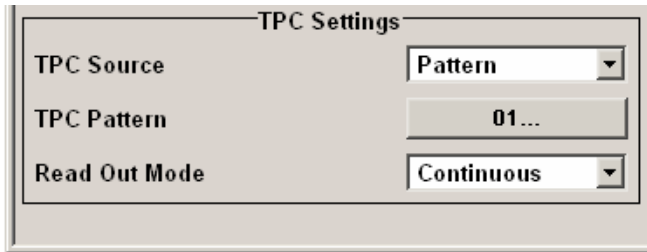

The **TPC Settings** section is where the TPC field is set.

**Slot Structure – TD-SCDMA** Displays the slot structure.

The structure of the slot depends on the slot format selected.



Remote-control command: n.a.

**Slot Format – TD-SCDMA** Displays the slot format.

The slot format display changes when the **Number of TFCI Bits** and the **Number of Sync Shift & TPC Bits** are modified.

Remote-control command:

SOUR:BB:TDSC:DOWN:CELL1:SLOT3:CHAN6:SFOR?

Response: 0

**Midamble Shift – TD-SCDMA**

Displays the midamble shift.

The midamble can be shifted in the range of 0 to 120 chips in increments of 8 chips. Channels belonging to the same user equipment are characterized by the same midamble shift.

Remote-control command:

SOUR:BB:TDSC:DOWN:CELL1:SLOT3:CHAN6:MSH?

Response: 120

**Number of TFCI Bits – TD-SCDMA**

Selects the length of the TFCI field expressed in bits.

Remote-control command:

SOUR:BB:TDSC:DOWN:CELL1:SLOT3:CHAN6:DPCC:TFC:LEN 4

**TFCI Value – TD-SCDMA**

Enters the value of the TFCI field. The value range is 0 to 1023.

The coded TFCI word is divided into 4 parts:

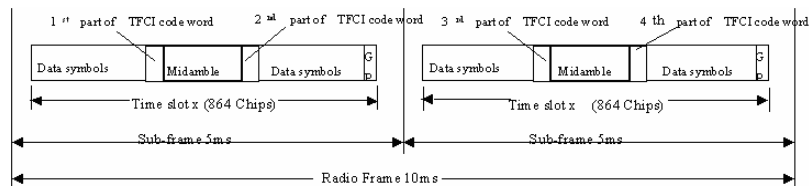

Remote-control command:

SOUR:BB:TDSC:DOWN:CELL1:SLOT3:CHAN6:DPCC:TFCI:VAL 2



**Number of Sync Shift & TPC Bits – TD-SCDMA**

Selects the length of the sync shift and the length of the TPC field expressed in bits. The available values depend on the slot format.

Remote-control command:

```
SOUR:BB:TDSC:DOWN:CELL1:SLOT3:CHAN6:DPCC:SYNC:LEN 4
```

**Sync Shift Pattern – TD-SCDMA**

Enters the bit pattern for the sync shift. The maximum pattern length is 64 bits.

The following values are allowed:

0: decreases the sync shift

1: increases the sync shift

-: the sync shift stays unchanged

Remote-control command:

```
SOUR:BB:TDSC:DOWN:CELL1:SLOT3:CHAN6:DPCC:SYNC:PATT
10-01
```

**Sync Shift Repetition M – TD-SCDMA**

Enters the value for the sync shift repetition. This value defines the spacing for the sync shift which is used to transmit a new timing adjustment. M specifies the spacing in subframes of 5 ms each.

Remote-control command:

```
SOUR:BB:TDSC:DOWN:CELL1:SLOT3:CHAN6:DPCC:SYNC:REP 2
```

**TPC Source – TD-SCDMA**

Selects the data source for the TPC field of the DPCCCH.

If **Pattern** is selected, an entry field appears for the bit pattern. The maximum bit pattern length is 64 bits.

The screenshot shows a control panel for 'TPC Source'. A dropdown menu is set to 'Pattern'. Below it, a text field labeled 'TPC Pattern' contains the value '01'. There is also a 'Read Out Mode' label below the text field.

If **Data List** is selected, a button appears for calling the **File Select** window.

The screenshot shows the 'TPC Source' control panel with the dropdown menu set to 'Data List'. A button labeled 'Select TPC List...' is visible below the dropdown. The 'None' option is also visible at the bottom right of the panel.

Remote-control command:

```
SOUR:BB:TDSC:DOWN:CELL1:SLOT3:CHAN6:DPCC:TPC:DATA
ONE
```

```
SOUR:BB:TDSC:DOWN:CELL1:SLOT3:CHAN6:DPCC:TPC:DATA:P
ATT #HFF,8
```

```
SOUR:BB:TDSC:DOWN:CELL1:SLOT3:CHAN6:DPCC:TPC:DATA:D
SEL 'c:\data1'
```

**Read Out Mode – TD-SCDMA**

Selects TPC data usage.

With TD-SCDMA, the TPC bits are used to signal the increase or reduction in transmit power to the called station. With all read out modes, one bit is taken from the data stream for the TPC field for each slot and entered into the bit stream several times (depending on the symbol rate). The difference between the modes lies in the usage of the TPC bits.

These different modes can be used, for example, to deliberately set a base station to a specific output power (e.g. with the pattern 11111) and then let it oscillate around this power (with Single + alt. 01 and Single + alt. 10). This then allows power measurements to be carried out at the base station (at a quasi-constant power).

**Continuous**

The TPC bits are used cyclically.

Remote-control command:

```
SOUR:BB:TDSC:DOWN:CELL1:SLOT3:CHAN6:D
PCC:TPC:READ CONT
```

**Single + All 0**

The TPC bits are used once, and then the TPC sequence is continued with 0 bits.

Remote-control command:

```
SOUR:BB:TDSC:DOWN:CELL1:SLOT3:CHAN6:D
PCC:TPC:READ S0A
```

**Single + All 1**

The TPC bits are used once, and then the TPC sequence is continued with 1 bits.

Remote-control command:

```
SOUR:BB:TDSC:DOWN:CELL1:SLOT3:CHAN6:D
PCC:TPC:READ S1A
```

**Single + alt.01**

The TPC bits are used once, and then the TPC sequence is continued with 0 and 1 bits alternately (in multiples, depending on by the symbol rate, for example, 00001111).

Remote-control command:

```
SOUR:BB:TDSC:DOWN:CELL1:SLOT3:CHAN6:D
PCC:TPC:READ S01A
```

**Single + alt.10**

The TPC bits are used once, and then the TPC sequence is continued with 1 and 0 bits alternately (in multiples, depending on by the symbol rate, for example, 11110000).

Remote-control command:

```
SOUR:BB:TDSC:DOWN:CELL1:SLOT3:CHAN6:D
PCC:TPC:READ S10A
```

# Slot Mode PRACH Settings – TD-SCDMA

The PRACH settings menu can be called by selecting slot mode **PRACH** in the **Slot Configuration** menu.

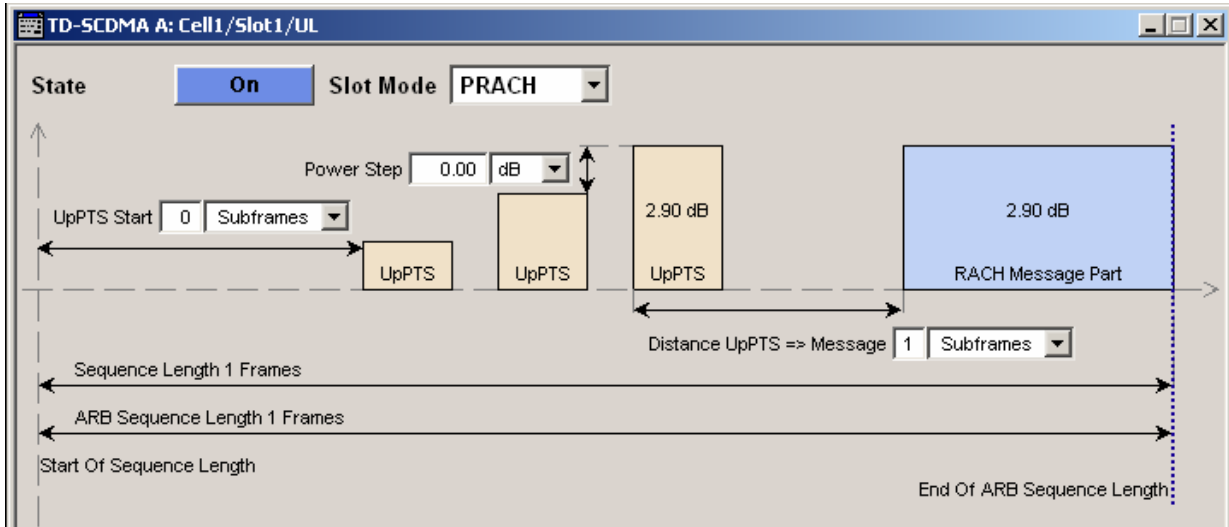

UpPTS	
Power	0.00 dB
UpPTS Repetition	1

RACH Message Part	
State	On
Slot Format	0
Spreading Factor	16
Data Source	PN 9
Current User	1
Message Length	1 Subframe (5 ms)
Power	0.00 dB
Spreading Code	1
Midamble Shift	120

**Power Step – TD-SCDMA** Enters the power by which the UpPTS is increased from repetition to repetition. The power set under **Power** is the „target power“, used during the last repetition of the preamble.

**Example:**

UpPTS Power: 0 dB

UpPTS Repetition: 3

Power Step: 3

Generated power sequence:

Preamble 1 -6 dB	→ + 3 dB	Preamble 2 -3 dB	→ + 3 dB	Preamble 3 0 dB
---------------------	----------	---------------------	----------	--------------------

Remote-control command:

SOUR:BB:TDSC:UP:CELL1:SLOT3:PRAC:PTS:PSTE 5

**UpPTS Start – TD-SCDMA** Enters the number of the subframe in which the first UpPTS should be transmitted. The value range is 0 to 10.

Remote-control command:

SOUR:BB:TDSC:UP:CELL1:SLOT3:PRAC:PTS:STAR 2

**Distance UpPTS – TD-SCDMA** Enters the value to vary the timing between UpPTS and RACH.

Remote-control command:

SOUR:BB:TDSC:UP:CELL1:SLOT3:PRAC:PTS:DIST 2

**Power – TD-SCDMA** Enters the power of the UpPTS.

Remote-control command:

SOUR:BB:TDSC:UP:CELL1:SLOT3:PRAC:PTS:POW -20

**UpPTS Repetition – TD-SCDMA** Enters the number of UpPTS repetitions before a PRACH burst happens.

Remote-control command:

SOUR:BB:TDSC:UP:CELL1:SLOT3:PRAC:PTS:REP 2

**State (RACH Message Part) – TD-SCDMA** Activates or deactivates the RACH (random access channel) message part.

Remote-control command:

SOUR:BB:TDSC:UP:CELL1:SLOT3:PRAC:MSG:STAT ON

**Message Length – TD-SCDMA** Selects the message length of the random access channel expressed in subframes.

Remote-control command:

SOUR:BB:TDSC:UP:CELL1:SLOT3:PRAC:MSG:LEN 2

<b>Slot Format (PRACH) – TD-SCDMA</b>	<p>Displays the slot format of the PRACH. The slot format depends on the selected spreading factor.</p> <p>Remote-control command:  SOUR:BB:TDSC:UP:CELL1:SLOT3:PRAC:MSG:SFOR?</p> <p>Response: 0</p>
<b>Power (RACH Message Part) – TD-SCDMA</b>	<p>Enters the power of the PRACH message part. The value range is -80 dB to 0 dB.</p> <p>Remote-control command:  SOUR:BB:TDSC:UP:CELL1:SLOT3:PRAC:MSG:POW -10</p>
<b>Spreading Factor (PRACH) – TD-SCDMA</b>	<p>Selects the spreading factor for the PRACH.</p> <p>Remote-control command:  SOUR:BB:TDSC:UP:CELL1:SLOT3:PRAC:MSG:SFAC 4</p>
<b>Spreading Code (PRACH)– TD-SCDMA</b>	<p>Enters the spreading code for the PRACH. The code channel is spread with the set spreading code. The range of values of the spreading code depends on the channel type and the spreading factor.</p> <p>Remote-control command:  SOUR:BB:TDSC:UP:CELL1:SLOT3:PRAC:MSG:SCOD 2</p>
<b>Data Source (PRACH) – TD-SCDMA</b>	<p>Selects data source for the PRACH.</p> <p>The data sources <b>PN9</b>, <b>PN11</b>, <b>PN15</b>, <b>PN16</b>, <b>PN20</b>, <b>PN21</b>, <b>PN23</b>, <b>ALL0</b>, <b>ALL1</b>, <b>Pattern</b> and <b>Data List</b> are available to choose from.</p> <p>If the <b>Pattern</b> data type is used, the bit pattern can be entered in a bit editor via the <b>Data Pattern 0...</b> button. The length is limited to 64 bits.</p> <p>If the <b>Data List</b> data type is used, the list can be selected from a file window via the <b>Select Data List...</b> button..</p> <p>Remote-control command:  SOUR:BB:TDSC:UP:CELL1:SLOT3:PRAC:MSG:DATA PN16</p> <p>SOUR:BB:TDSC:UP:CELL1:SLOT3:PRAC:MSG:DATA:DSEL  'c:\data1'</p> <p>SOUR:BB:TDSC:UP:CELL1:SLOT3:PRAC:MSG:DATA:PATT  #HFF,8</p>
<b>Current User (PRACH) – TD-SCDMA</b>	<p>Enters the number of current user.</p> <p>Remote-control command:  SOUR:BB:TDSC:UP:CELL1:SLOT3:PRAC:MSG:USER 2</p>
<b>Midamble Shift (PRACH) – TD-SCDMA</b>	<p>Displays the value for the midamble shift.</p> <p>Remote-control command:  SOUR:BB:TDSC:UP:CELL1:SLOT3:PRAC:MSG:MSH?</p>

## Code Domain – TD-SCDMA

The channelization codes are taken from a code tree of hierarchical structure (see below). The higher the spreading factor, the smaller the symbol rate and vice versa. The product of the spreading factor and symbol rate is constant and always yields the chip rate.

The outer branches of the tree (right-most position in the figure) indicate the channelization codes for the smallest symbol rate (and thus the highest spreading factor). The use of a channelization code of the level with spreading factor N blocks the use of all other channelization codes of levels with spreading factor >N available in the same branch of the code tree. Channelization codes with smaller spreading factor are contained in the codes with larger spreading factor in the same code branch. When using such competitive channelization codes at the same time, the signals of associated code channels are mixed such that they can no longer be separated in the receiver. Orthogonality will then be lost.

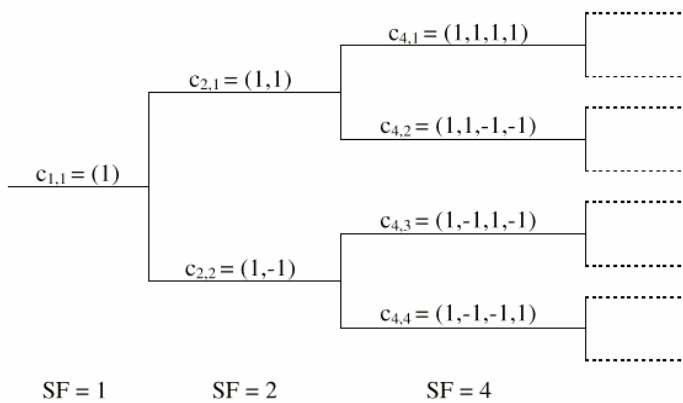

Code tree of channelization codes

The domain of a certain channelization code is the outer branch range (with minimum symbol rate and max. spreading factor) which is based on the channelization code selected in the code tree. Using a spreading code means that its entire domain is used.

The Code Domain display indicates the assigned code domain. The channelization code is plotted at the X axis, the colored bars indicate coherent code channels. The colors are assigned to the spreading factor, the allocation is shown below the graph. The relative power can be taken from the height of the bar.

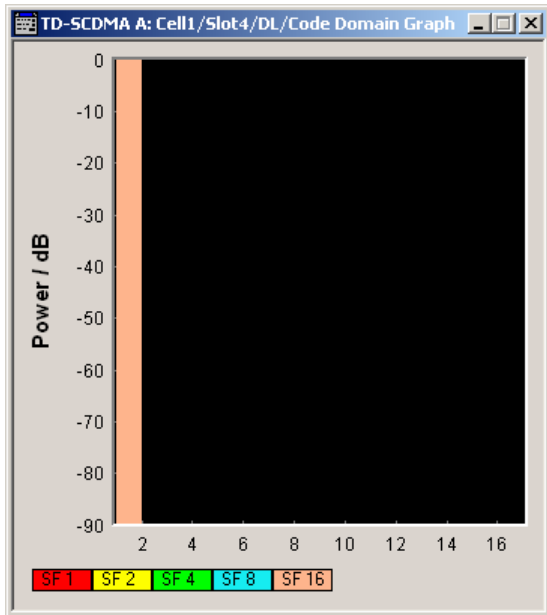

## Channel Graph – TD-SCDMA

The channel graph display shows the active code channels. The channel number is plotted on the X axis. The red bars represent the special channel (P-CCPCH1 to PDSCH in the downlink, P-CCPCH1 to PUSCH in the uplink), the green bars the data channels (DPCH). The height of the bars shows the relative power of the channel. The graph is calculated from the settings that have been made.

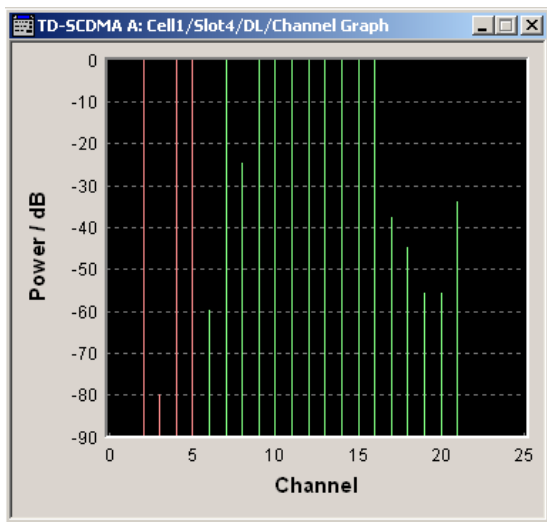





## Contents Chapter 5 - Remote Control - Basics

<b>5 Remote Control - Basics .....</b>	<b>5.1</b>
Introduction - Remote Control Basics.....	5.1
Getting Started .....	5.2
Switchover to Remote Control.....	5.3
Remote Control via IEC/IEEE Bus .....	5.4
Remote Control via LAN Interface.....	5.5
Interface and Device Messages .....	5.11
Interface Messages .....	5.11
Device Messages (Commands and Device Responses).....	5.11
SCPI Command Structure and Syntax.....	5.12
Structure of a Command Line .....	5.15
Responses to Queries .....	5.15
Parameters .....	5.16
Overview of Syntax Elements .....	5.18
Instrument Model and Command Processing .....	5.19
Input Unit .....	5.19
Command Recognition .....	5.20
Data Base and Instrument Hardware .....	5.20
Status Reporting System.....	5.21
Output Unit .....	5.21
Command Sequence and Command Synchronization .....	5.21
Status Reporting System.....	5.22
Overview of the Status Register .....	5.23
Status Byte (STB) and Service Request Enable Register (SRE) .....	5.23
IST-Flag and Parallel Poll Enable Register (PPE) .....	5.25
Event Status Register (ESR) and Event Status Enable Register (ESE).....	5.25
Application of the Status Reporting System.....	5.26
Reset Values of the Status Reporting Systems .....	5.27
Remote Control Hardware Interfaces.....	5.28
IEC/IEEE Bus Interface .....	5.28
LAN Connector .....	5.31



# 5 Remote Control - Basics

## Introduction - Remote Control Basics

This chapter provides:

- Instructions on how to set up the signal generator for remote control operation.
- A general introduction to remote control of programmable instruments. This includes the description of the command structure and syntax according to the SCPI standard, the description of command execution and of the status registers.
- A description of the remote control interfaces.

In chapter 6, all remote control functions are described in detail. The subsystems are listed by alphabetical order according to SCPI. All commands and their parameters are listed by alphabetical order in the command list at the end of chapter 6. A list is provided for users of the Vector Signal Generator R&S SMIQ, which shows all commands of the R&S SMATE that are compatible with the command set of the R&S SMIQ.

The instrument is equipped with the following interfaces for remote control:

- IEC/IEEE bus interface according to standard IEC 625.1/IEEE 488.2
- LAN interface: the network card uses 10/100/1000Mbps Ethernet IEEE 802.3u; the protocol is based on the VXI-11 standard.

The connectors are located at the rear of the instrument and permit a connection to a controller for remote control either directly or via a local area network (LAN). The remote control interfaces and their interface functions are described in section "[Remote Control Hardware Interfaces](#)".

SCPI (**S**tandard **C**ommands for **P**rogrammable **I**nstruments) commands - messages - are used for remote control. Commands that are not taken from the SCPI standard follow the SCPI syntax rules. The instrument supports the SCPI version 1999. The SCPI standard is based on standard IEEE 488.2 and aims at the standardization of device-specific commands, error handling and the status registers. The tutorial "Automatic Measurement Control – A tutorial on SCPI and IEEE 488.2" from John M. Pieper (R&S order number 0002.3536.00) offers detailed information on concepts and definitions of SCPI. Not all of the commands supported by the instrument are taken from the SCPI standard, however, their syntax follows SCPI rules.

This section assumes basic knowledge of programming and operation of the controller. A description of the interface commands can be obtained from the relevant manuals.

The requirements that the SCPI standard places on command syntax, error handling and configuration of the status registers are explained in detail in the following sections. Tables provide a fast overview of the bit assignment in the status registers. The tables are supplemented by a comprehensive description of the status registers.

The program examples for IEC/IEEE-bus programming are all written in VISUAL BASIC. A condition for programming in VISUAL BASIC is that the modules NIGLOBAL (Niglobal.bas) and VBIB32 (Vbib\_32.bas) are added to the projects.

---

**Note:** *Manual control is designed for maximum possible operating convenience. In contrast, the priority of remote control is the "predictability" of the device status. Therefore, control programs should always define an initial device status (e.g. with the command \*RST) and then implement the required settings.*

---

## Getting Started

The short and simple operating sequence given below permits fast putting into operation of the instrument and setting of its basic functions. As a prerequisite, the IEC/IEEE-bus address, which is factory-set to 28, must not have been changed.

- Connect instrument and controller using IEC/IEEE-bus cable and switch them on.
- Write and start the following program on the controller:

CALL IBFIND("DEV1", generator%)	'Open port to the instrument
CALL IBPAD(generator%, 28)	'Inform controller about instrument address
CALL IBWRT(generator%, "*RST;*CLS")	'Reset instrument
CALL IBWRT(generator%, "FREQ 50MHz")	'Set frequency to 50 MHz
CALL IBWRT(generator%, "POW -7.3dBm")	'Set output level -7.3m dBm
CALL IBWRT(generator%, "OUTP:STAT ON")	'Switch on RF output A
CALL IBWRT(generator%, "AM:SOUR INT")	'Set AM modulation source LFGEN
CALL IBWRT(generator%, "LFO:FREQ 15kHz")	'Set modulation frequency to 15 kHz
CALL IBWRT(generator%, "AM 30PCT")	'Set AM modulation depth 30%
CALL IBWRT(generator%, "AM:STAT ON")	'Switch on AM

An amplitude-modulated signal is now applied at the RF-output A of the instrument.

- To return to manual control, press the **LOCAL** key at the front panel.

## Switchover to Remote Control

On power-on, the instrument is always in the manual operating state and can be operated via external mouse, keyboard and monitor.

In case of remote control via the IEC/IEEE bus, the instrument is set to remote control (REMOTE status) by means of an addressed command.

With remote control via Ethernet, remote control is not automatically set by means of a command. The instrument must be explicitly set to the REMOTE state, e.g. by sending the interface command **&GTR** (go to remote).

In the REMOTE state, instrument control via external mouse, keyboard and monitor is disabled. Menus can be opened, however, e.g. to verify settings. Buttons and setting fields are displayed in gray and cannot be activated. REMOTE is displayed in the status line.

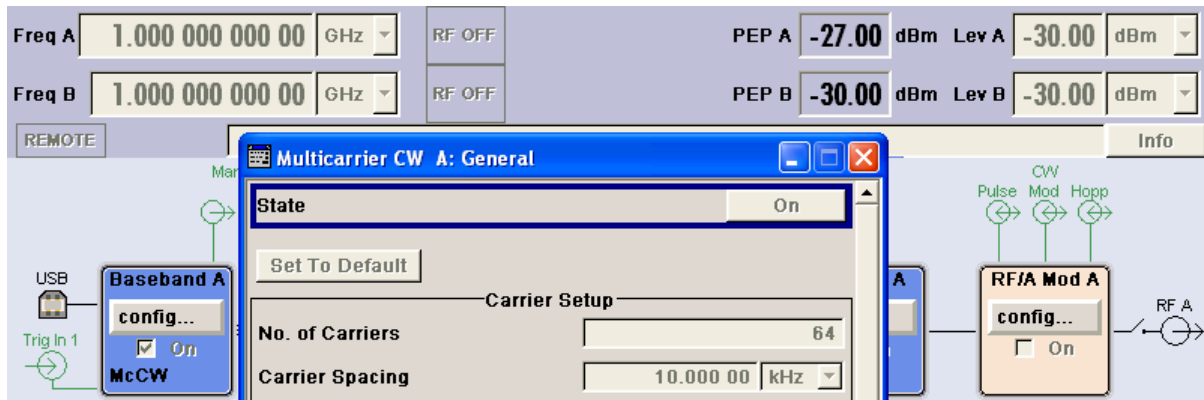

The instrument remains in the REMOTE mode until local control is selected either manually with the CTRL+Q key combination on the external keyboard or with the interface command **&GTL** via the remote-control interface.

Switching from manual operation to remote control and vice versa does not affect the remaining instrument settings.

In the remote control mode, an external mouse or keyboard that may be connected can be disabled with command `:SYST:KLOC ON`. Menus cannot be opened in this case and switchover from remote control to manual operation is only possible by means of a remote-control command. Inadvertent switchover with the CTRL+Q key combination is not possible in this case.

Operation of the CTRL+Q key combination alone can be disabled with interface command **&LLO**.

## Remote Control via IEC/IEEE Bus

To be able to control the instrument via the IEC/IEEE bus, instrument and controller must be linked by an IEC/IEEE-bus cable. An IEC/IEEE-bus card, the card drivers and the program libraries for the programming language used must be provided in the controller.

The controller must address the instrument with the set IEC/IEEE-bus address. The IEC/IEEE bus address of the instrument is factory-set to 28. It can be changed via IEC/IEEE bus with command `SYSTem:COMMunicate:GPIB: ADDRess` or manually in the **Environment - GPIB** menu. Addresses 0 to 30 are permissible.

Manually:

Setup - Remote - GPIB ...



Via IEC/IEEE bus:

<code>CALL IBFIND("DEV1", generator%)</code>	'Open port to the instrument
<code>CALL IBPAD(generator%, 28)</code>	'Inform controller about old address
<code>CALL IBWRT(generator%, "SYST:COMM:GPIB:ADDR 18")</code>	'Set instrument to new address
<code>CALL IBPAD(generator%, 18)</code>	'Inform controller about new address

Sending the first command starts remote control operation.

Return to manual operation is possible via the front panel or the IEC/IEEE bus.

Manually:

➤ Press the CTRL+Q key combination.

---

**Notes:**

- Before the transition, command processing must be completed as otherwise transition to remote control is performed immediately.
  - The CTRL+Q key combination can be disabled by the interface message &LLO (see section ["IEC/IEEE-Bus Interface Functions"](#), on page 5.29) in order to prevent unintentional transition. In this case, transition to manual mode is only possible via the IEC/IEEE bus.
  - The CTRL+Q key combination can be enabled again by deactivating the REN line of the IEC/IEEE bus (see section ["IEC/IEEE-Bus Interface Functions"](#), on page 5.29).
- 

Via IEC/IEEE bus:

...  
`CALL IBLOC(generator%)` 'Set instrument to manual operation  
 ...

## Remote Control via LAN Interface

For remote control via a network, the PC and the instrument must be connected via the LAN interface to a common network with TCP/IP network protocol. Connection of the R&S SMATE to a network and the querying of a computer name is described in Chapter 1, section "[Query Computer Name](#)", on page 1.24.

**Important:** *In contrast to file transfer via LAN which requires only a partial permission (exception) in the firewall, remote control via LAN is only possible if the firewall is completely switched off. Therefore, the firewall settings for remote control differ from the firewall settings for file transfer (see following description).*

Setting for Remote Control:

**Start – Control Panel – Switch to Classic View – Windows Firewall – Off (not recommended)**

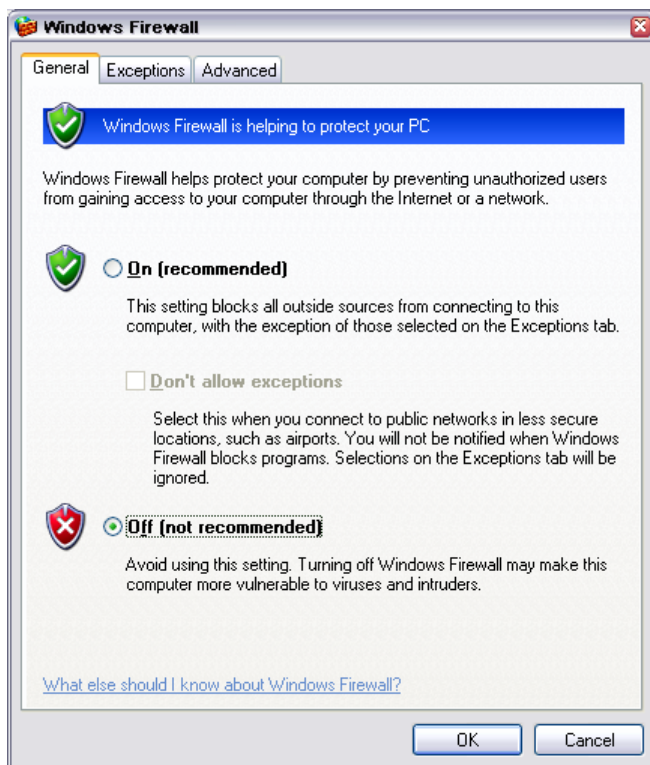

**Caution:**

*It is recommend to enable the Windows Firewall again after termination of remote control via LAN (setting **On (recommended)**) in order to protect the instrument from an attack of hostile users or programs via the net.*

Software for instrument control and the VISA program library must be installed on the controller. Instrument control is via the VXI-11 standard protocol.

Only the IP address or the computer name is required for link setup. The IP address/computer name is part of the "resource name" used by the programs for identification and control of the instrument. The resource name has the form:

**TCPIP::ipaddr::inst0::INSTR**

**ipaddr** has to be replaced by the IP address or the computer name of the instrument.

For instance, if the instrument has the IP address 192.1.2.3, TCPIP::192.1.2.3::inst0::INSTR is the valid resource name. Specification of **inst0** in the resource name is optional. In this example, also TCPIP::192.1.2.3::INSTR is therefore a valid resource name.

A resource name with computer name could be TCPIP::RSSMATE1::INSTR, for instance.

**TCPIP** designates the network protocol used and **INSTR** indicates that the VXI-11 protocol is used.

If several instruments are connected to the network, each instrument has its own IP address and associated resource name. The controller identifies these instruments by means of the resource name.

In the example below, the program 'Measurement & Automation Explorer' from National Instruments is used for setting up an Ethernet remote-control link. Link setup with this program is easy and first tests can be performed. The R&S SMATE is preconfigured for networks using DHCP (dynamic host configuration protocol). If this configuration is used, the computer name must be entered at the position of the IP address. It is also possible to assign a fixed IP address to the R&S SMATE (see Chapter 1, section "[Configuring the R&S SMATE for Network Operation](#)", on page 1.20).

## Setting up Control of the R&S SMATE in the 'Measurement & Automation Control' Program.

- Start program on the controller
- Open the **Create new** menu with the right mouse key.

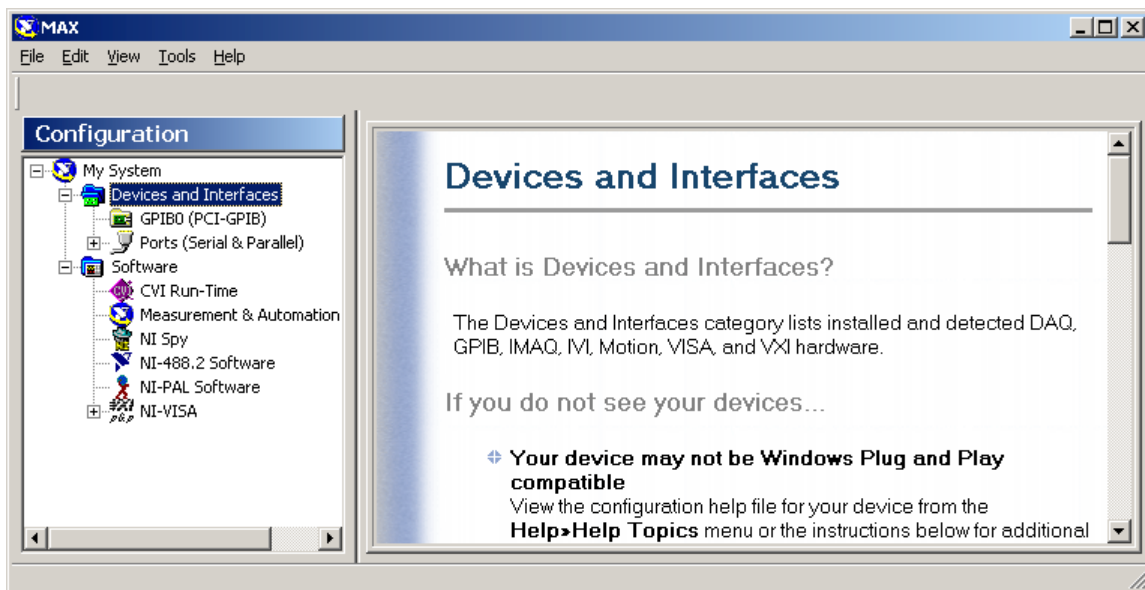



- Select **TCP/IP Resource** and open the next page of the **Create new** menu with the right mouse key.

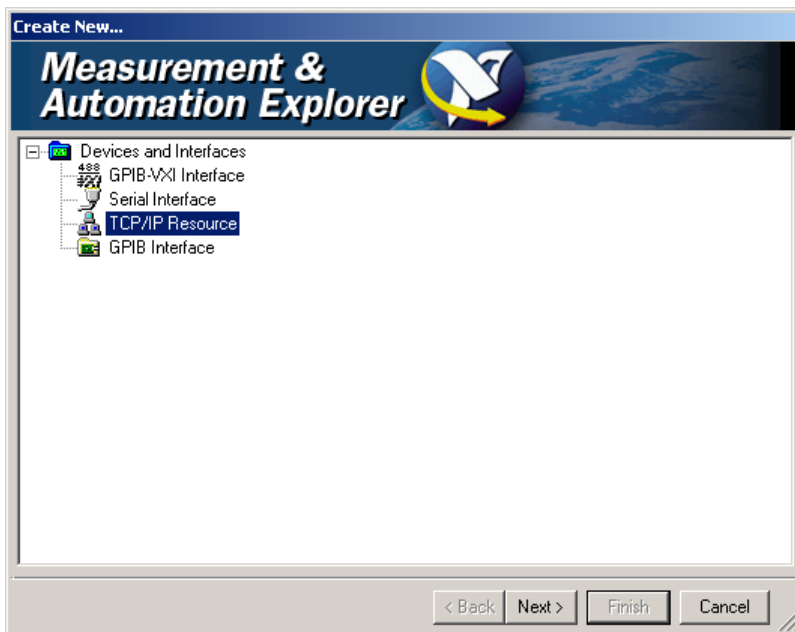

- Enter the IP address of the R&S SMATE and select **VXI-11 Instrument** (the computer name may be entered instead).

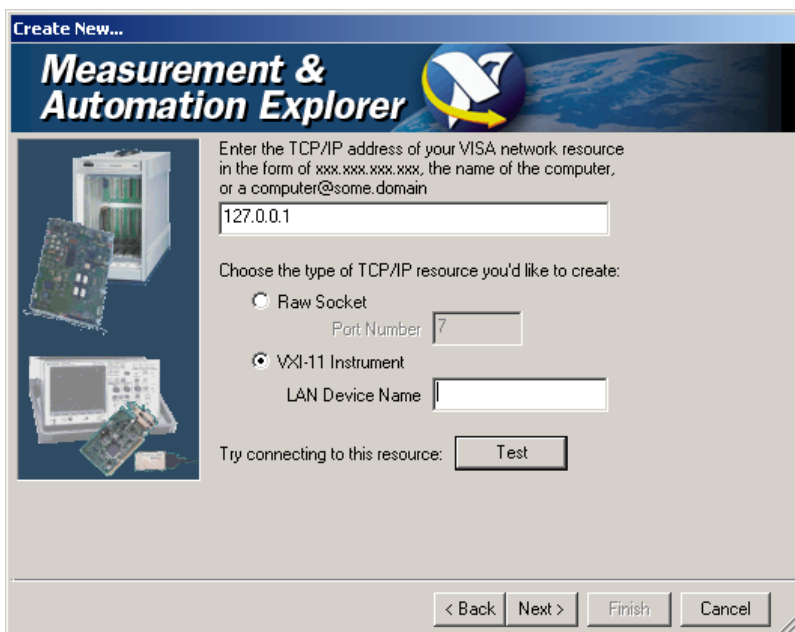

- Press the **Test** button

A message indicates whether the link to the R&S SMATE can be set up or not. If a connection cannot be set up, check whether the controller and the instrument are connected to the network (network cable) and switched on. Correct spelling of the IP address or the computer name can also be checked. For further error location, inform the network administrator. In large networks, specification of additional addresses may be required for link setup, e.g. gateway and subnet mask, which are known to the network administrator.

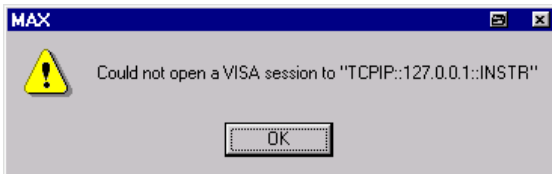
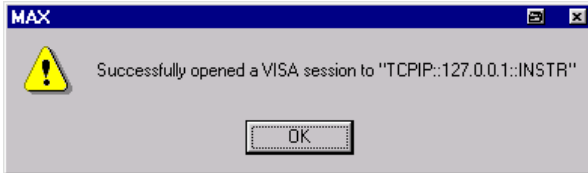

- Press the **Next** button. An alias name for the instrument can be entered in the next window. This name must not be mistaken for the computer name. It is only used for instrument identification within the program and displayed in the menu as an option in case of an Ethernet link.

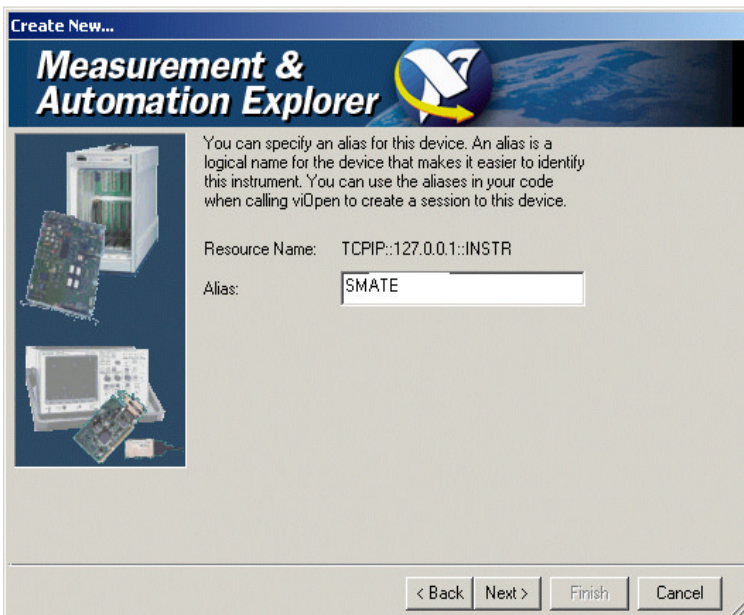

- Press **Next** and then the **Finish** button.  
The instrument is now registered in the program and can be addressed via the resource or alias name.

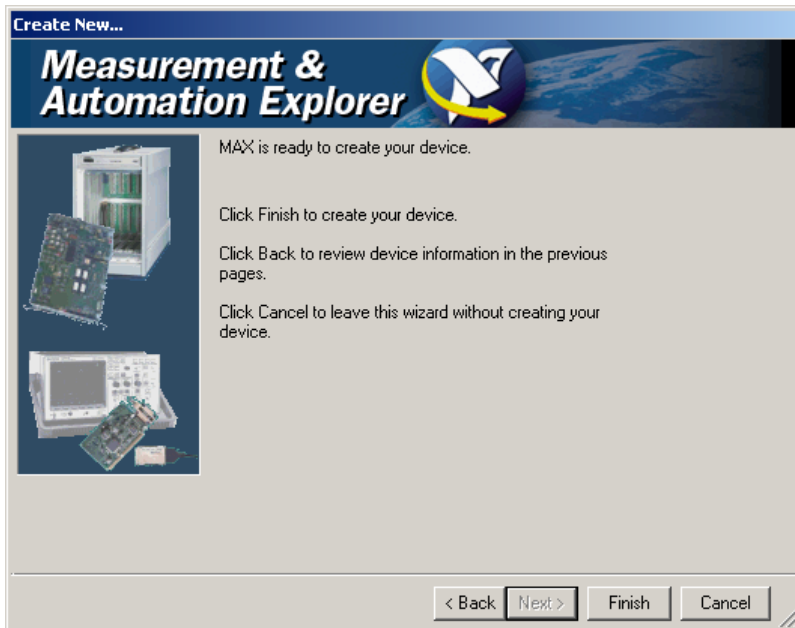

### Starting the Measurement & Automation program for remote control of the R&S SMATE

- Start program on the controller
- In the **Configuration** window, open **Instruments and Interfaces** and select R&S SMATE (= Alias) under **VISA Ethernet Devices**.
- Open the menu by clicking **Open VISA Session** with the right mouse key.

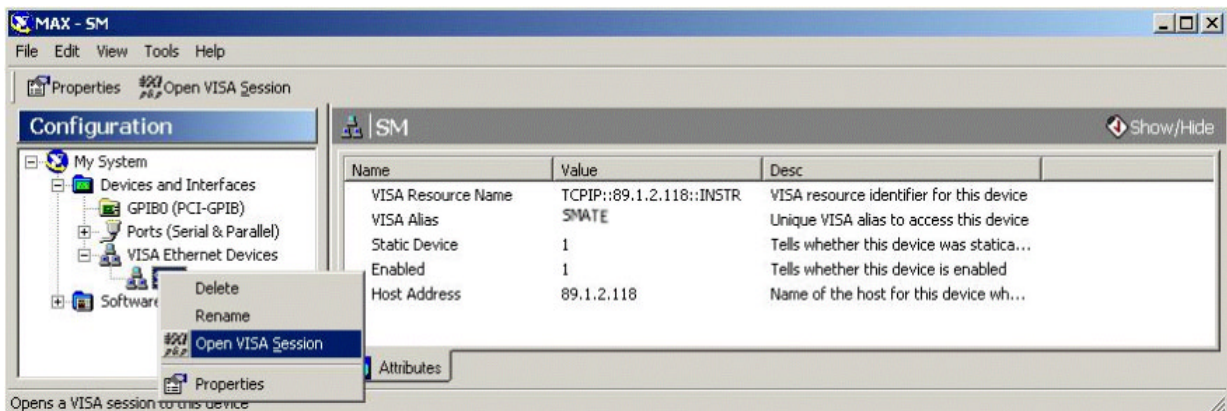

- On the **viWrite** tab under **Basic I/O**, commands can be sent to the instrument; instrument responses are displayed on the **viRead** tab (for further program operation refer to the online help of the program).

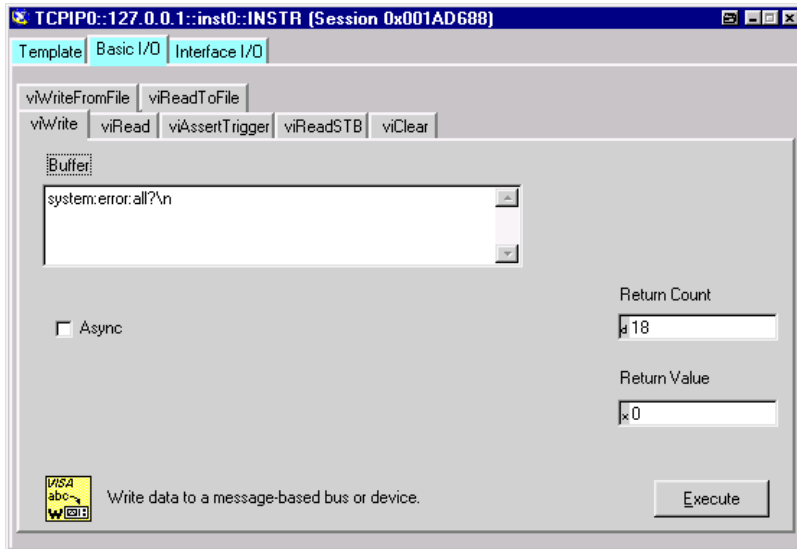

Return to manual operation is possible either manually with the CTRL+Q key combination on the external keyboard or via the LAN interface.

**Manually:**

- Press the CTRL+Q key combination.

---

**Notes:**

- The CTRL+Q key combination can be disabled by the universal command &LLO (see section "VXI-11 Interface Messages", on page 5.33) in order to prevent unintentional transition. In this case, transition to manual mode is only possible via remote control.
  - The CTRL+Q key combination can be enabled again by the interface message &NREN (see section "VXI-11 Interface Messages", on page 5.33).
- 

**Via IEC/IEEE bus:**

```
...
CALL IBLOC(generator%) 'Set instrument to manual operation
...
```

## Interface and Device Messages

The messages transferred via the data lines of the IEC/IEEE-bus (see section "[Bus Lines](#)", on page 5.28) or via a TCP/IP network can be divided into two groups:

- **interface messages** and
- **device messages.**

### Interface Messages

Interface messages are transferred on the data lines of the IEC/IEEE bus, the ATN control line being active. They are used for communication between controller and instrument and can only be sent by a computer which has the function of an IEC/IEEE bus controller. Interface commands can be further subdivided into

- **universal commands**
- **addressed commands**

Universal commands act on all devices connected to the IEC/IEEE-bus without previous addressing, addressed commands only act on devices previously addressed as listeners. The interface messages relevant to the instrument are listed in section "[IEC/IEEE-Bus Interface Functions](#)", on page 5.29".

If an Ethernet connection is present, signalling via a hardware control line is not required. The IEC/IEEE-bus interface commands are emulated (see "[VXI-11 Interface Messages](#)", on page 5.33).

### Device Messages (Commands and Device Responses)

Device messages are transferred on the data lines of the IEC/IEEE-bus, the "ATN" control line not being active. ASCII character set is used.

If an Ethernet connection is present, signalling via a hardware control line is not required.

The device messages are equal for the different interfaces (IEC/IEEE bus and Ethernet). A distinction is made according to the direction in which they are sent:

**Commands** (Program Messages) are messages the controller sends to the instrument. They operate the device functions and request information.

The commands are subdivided according to two criteria:

1. According to the effect they have on the instrument:

**Setting commands** cause instrument settings such as a reset of the instrument or setting the frequency.

**Queries** cause data to be provided for output on the IEC/IEEE bus, e.g. for identification of the device or polling a parameter value. Queries are formed by directly appending a question mark to the header.

2. According to their definition in standard IEEE 488.2 and SCPI:

**Common Commands** are exactly defined as to their function and notation in standard IEEE 488.2. They refer to functions such as management of the standardized status registers, reset and selftest.

**Device-specific Commands** refer to functions depending on the features of the instrument such as frequency setting. A majority of these commands has also been standardized by the SCPI committee. Device-specific extensions following the SCPI rules are permitted by the standard.

**Device responses** (Response Messages and Service Request) are messages the instrument sends to the controller after a query. They can contain measurement results, instrument settings and information on the instrument status (cf. Section "[Responses to Queries](#)", page 5.15).

Structure and syntax of the device messages are described in the following Section.

## SCPI Command Structure and Syntax

The commands consist of a so-called header and, in most cases, one or more parameters. The header and parameter are separated by a "white space" (ASCII code 0 to 9, 11 to 32 decimal, e.g. blank). The headers may consist of several key words. Queries are formed by directly appending a question mark to the header.

---

**Note:** *The commands used in the following examples are not in every case implemented in the instrument.*

---

**Common Commands** Common commands consist of a header preceded by an asterisk "\*" and one or more parameters, if any.

**Examples:**

- \*RST            RESET, resets the device
- \*ESE 253        EVENT STATUS ENABLE, sets the bits of the event status enable register
- \*ESR?            EVENT STATUS QUERY, queries the contents of the event status register.

**Device-specific commands**

**Hierarchy:** Device-specific commands are of hierarchical structure (see figure below). The different levels are represented by combined headers. Headers of the highest level (root level) have only one key word. This key word denotes a complete command system

**Example:** SOURce

This key word denotes the command system SOURce.

For commands of lower levels, the complete path has to be specified, starting on the left with the highest level, the individual key words being separated by a colon ":".

**Example:** `SOURce:FM:EXTernal:COUPling AC`

This command lies in the fourth level of the `SOURce`. It sets the coupling of the external signal source to AC.

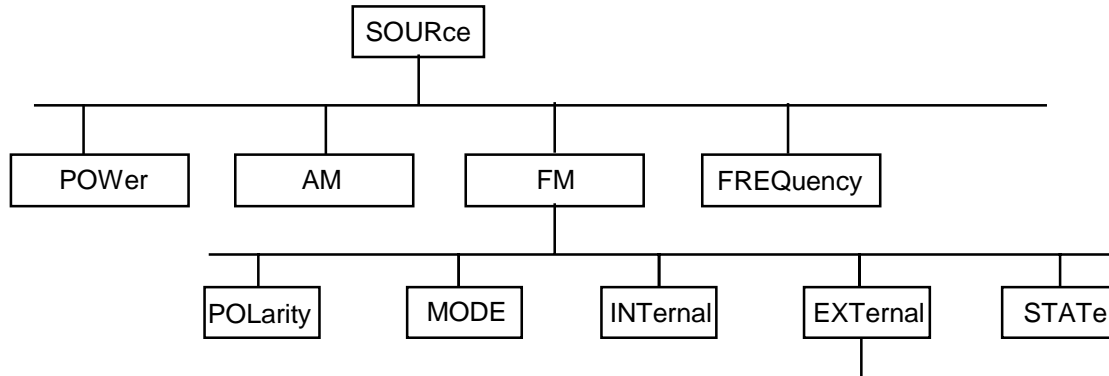

Figure 5-1 Example for the tree structure of the SCPI command systems; the `SOURce` system

#### Multiple key words

Some key words occur on several levels within one command system. Their effect depends on the structure of the command, i. e. on the position in the command header they are inserted in.

#### Example:

`SOURce:FM:POLarity NORMal`

This command contains key word `POLarity` in the third command level. It defines the polarity between modulator and modulation signal.

`SOURce:FM:EXTernal:POLarity NORMal`

This command contains key word `POLarity` in the fourth command level. It defines the polarity between modulation voltage and the resulting direction of the modulation only for the external signal source indicated.

#### Optional key words:

Some command systems permit certain key words to be optionally inserted into the header or omitted. These key words are marked by square brackets in this manual. The full command length must be recognized by the instrument for reasons of compatibility with the SCPI standard. Some commands are considerably shortened by omitting optional key words.

#### Example:

`[SOURce]:POWer[:LEVel][:IMMediate]:OFFSet 1`

This command immediately sets the offset of the signal to 1 dB. The following command has the same effect:

`POWer:OFFSet 1`

---

**Note:** An optional key word must not be omitted if its effect is specified in detail by a numeric suffix. In the R&S SMATE, this for instance applies to the keyword `SOURce` which can always be omitted for path A = `SOURce1` but must always be specified for path B = `SOURce2`.

---

**Long and short form:** The key words feature a long form and a short form. Either the short form or the long form can be entered, other abbreviations are not permitted.

**Example:** `STATus:QUESTionable:ENABle 1= STAT:QUES:ENAB 1`

---

**Note:** *Upper-case and lower-case notation only serves to distinguish the two forms in the manual, the instrument itself does not distinguish upper-case and lower-case letters.*

---

**Parameters:** Parameters must be separated from the header by a "white space". If several parameters are specified in a command, they are separated by a comma ",". A few queries permit the parameters MINimum, MAXimum and DEFault to be entered. For a description of the types of parameter, refer to Section "[Parameters](#)", page 5.16.

**Example:** `SOURce:POWer:ATTenuation? MAXimum`      Answer: 60

this query requests the maximal value for the attenuation.

**Numeric suffix:** If a device features several functions or features of the same kind, e.g. several inputs, the desired function can be selected by a suffix added to the command. Entries without suffix are interpreted like entries with the suffix 1. Optional keywords must be specified if they select a function with the suffix.

**Example:**

`SOURce2:BB:DM:STATe ON`

This command activates digital modulation for path B. The keyword `SOURce` must be specified in the command.

This command activates digital modulation for path A. For path A, the keyword is optional and can be omitted.

---

**Note:** *In case of remote control, suffix counting may differ from the numbers of the corresponding selection used in manual operation. SCPI prescribes that suffix counting starts with 1. Suffix 1 is the default state and used when no specific suffix is specified. Some standards define a fixed numbering, starting with 0. With GSM, for instance, slots are counted from 0 to 7. In the case of remote control, the slots are selected with the suffixes 1 to 8. If the numbering differs in manual operation and remote control, it is indicated with the respective command.*

---



## Structure of a Command Line

A command line may consist of one or several commands. It is terminated by an EOI together with the last data byte.

Several commands in a command line must be separated by a semicolon ";". If the next command belongs to a different command system, the semicolon is followed by a colon. A colon ":" at the beginning of a command marks the root node of the command tree.

**Example:** "SOURce:POWer:CENTer MINimum;:OUTPut:STATe ON"

This command line contains two commands. The first command is part of the SOURce system and is used to specify the center frequency of the output signal of RF output A. The second command is part of the OUTPut system and sets the attenuation of the output signal of RF output A.

If the successive commands belong to the same system, having one or several levels in common, the command line can be abbreviated. To this end, the second command after the semicolon starts with the level that lies below the common levels (see also Figure 5-1). The colon following the semicolon must be omitted in this case.

**Example:** "SOURce:FM:MODE LOCKed;:SOURce:FM:INTernal:FREQuency 1kHz"

This command line is represented in its full length and contains two commands separated from each other by the semicolon. Both commands are part of the SOURce command system, subsystem FM, i.e. they have two common levels. When abbreviating the command line, the second command begins with the level below SOURce:FM. The colon after the semicolon is omitted.

The abbreviated form of the command line reads as follows:

"SOURce:FM:MODE LOCKed;INTernal:FREQuency 1kHz"

However, a new command line always begins with the complete path.

**Example:** "SOURce:FM:MODE LOCKed"

"SOURce:FM:INTernal:FREQuency 1kHz"

## Responses to Queries

A query is defined for each setting command unless explicitly specified otherwise. It is formed by adding a question mark to the associated setting command. According to SCPI, the responses to queries are partly subject to stricter rules than in standard IEEE 488.2.

1. The requested parameter is transmitted without header.

**Example:** SOURce:AM:EXTernal:COUPling? Answer: AC

2. Maximum values, minimum values and all further quantities, which are requested via a special text parameter are returned as numerical values

**Example:** SOURce:FREQuency? MAX Answer: 1E3

4. Boolean values are returned as 0 (for OFF) and 1 (for ON).

**Example:** OUTPut:STATe? Answer (for ON): 1

5. Text (character data) is returned in a short form

**Example:** SOURce:AM:SOURce? Answer (for EXTernal): EXT

## Parameters

Most commands require a parameter to be specified. The parameters must be separated from the header by a "white space". Permissible parameters are numerical values, Boolean parameters, text, character strings and block data. The type of parameter required for the respective command and the permissible range of values are specified in the command description.

**Numerical values** Numerical values can be entered in any form, i.e. with sign, decimal point and exponent. Values exceeding the resolution of the instrument are rounded up or down. The mantissa may comprise up to 255 characters, the values must be in the value range  $-9.9E37$  to  $9.9E37$ . The exponent is introduced by an "E" or "e". Entry of the exponent alone is not allowed.

**Units** In the case of physical quantities, the unit can be entered. Permissible unit prefixes are G (giga), MA (mega), MOHM and MHZ are also permissible), K (kilo), M (milli), U (micro) and N (nano). If the unit is missing, the basic unit is used.

**Example:**

```
SOURce:FREQuency 1.5 kHz = SOURce:FREQuency 1.5E3
```

Some settings allow relative values to be stated in percent. According to SCPI, this unit is represented by the PCT string.

**Example:**

```
SOURce2:SWEep:FREQuency:STEP:LOGarithmic 5PCT
```

**Special numeric values**

The texts MINimum, MAXimum, DEFault, UP and DOWN are interpreted as special numerical values.

In the case of a query, the associated numerical value is provided.

**Example:**

```
Setting command: SOURce:LFOuTput:VOLTage MAXimum
```

```
Query: SOURce:LFOuTput:VOLTage? Answer: 4
```

MIN/MAX MINimum and MAXimum denote the minimum and maximum value

DEF DEFault denotes a preset value. This value conforms to the default setting, as it is called by the \*RST command.

UP/DOWN UP, DOWN increases or reduces the numerical value by one step. The step width can be specified via an allocated step command for each parameter which can be set via UP, DOWN.

INF/NINF INFinity, Negative INFinity (NINF) represent the numerical values  $-9.9E37$  or  $9.9E37$ , respectively. INF and NINF are only sent as device responses.

NAN Not A Number (NAN) represents the value  $9.91E37$ . NAN is only sent as device response. This value is not defined. Possible causes are division by zero, subtraction or addition of infinite and the representation of missing values.

**Boolean Parameters** Boolean parameters represent two states. The ON state (logically true) is represented by ON or a numerical value unequal to 0. The OFF state (logically untrue) is represented by OFF or the numerical value 0. ON or OFF is returned by a query.

**Example:**

Setting command: `SOURce:AM:STATe ON`

Query: `SOURce:AM:STATe?` Answer: 1

**Text** Text parameters observe the syntax rules for key words, i.e. they can be entered using a short or long form. Like any parameter, they have to be separated from the header by a white space. In the case of a query, the short form of the text is provided.

**Example:**

Setting command: `SOURce:SWEep:POWer:MODE MANual`

Query: `SOURce:SWEep:POWer:MODE?` Answer: MAN

**Strings** Strings must always be entered within quotation marks (' or ").

**Example:** `:CORR:CSET "UCOR1"` or `:CORR:CSET 'UCOR1'`

**Block data** Block data are a transmission format which is suitable for the transmission of large amounts of data. A command using a block data parameter with definite length has the following structure:

**Example:** `MMEMory:DATA test_file.wv, #45168xxxxxxxx`

Test\_file.wv denotes the name of the file to which the data are written. The comma is followed by the binary data block. The hash symbol # introduces the data block. The next number indicates how many of the following digits describe the length of the data block. In the example the 4 following digits indicate the length to be 5168 bytes. The data bytes follow. During the transmission of these data bytes all End or other control signs are ignored until all bytes are transmitted.

The format of the binary files within the block depends on the IEC/IEEE-bus command

`SOURce:LIST:FREQuency | :POWer`

`SOURce:CORREction:CSET:DATA:FREQuency | :POWer`

use the IEEE-754 format for double precision floating point numbers. Each number is represented by 8 bytes.

**Example:**

`a# = 125.345678E6`

`b# = 127.876543E6`

`CALL IBWRT(generator%, "SOURCE:CORRECTION:CSET:DATA:FREQ #216" + MKD$(a#) + MKD$(b#))`

- #' in the command string introduces the binary block,
- '2' indicates that 2 digits specifying the length will follow next,
- '16' is the length of the binary block (in bytes), here: 2 double precision floating point number with 8 bytes each.
- The actual binary data follow now. As the function IBWRT requires a text string, MKD\$ is used for the type conversion.

The following ASCII format has the same effect:

`CALL IBWRT(generator%, "SOURCE:CORRECTION:CSET:DATA:FREQ 125.345678E6, 127.876543E6")`

## Overview of Syntax Elements

The following survey offers an overview of the syntax elements.

- : The colon separates the key words of a command. In a command line the separating semicolon marks the uppermost command level.
  - ; The semicolon separates two commands of a command line. It does not alter the path.
  - ,
  - ? The question mark forms a query.
  - \* The asterisk marks a common command.
  - " Quotation marks introduce a string and terminate it.
  - # The hash symbol # introduces binary, octal, hexadecimal and block data.
    - Binary: #B10110
    - Octal: #O7612
    - Hexa: #HF3A7
    - Block: #21312
- A "white space" (ASCII-Code 0 to 9, 11 to 32 decimal, e.g. blank) separates header and parameter.

## Instrument Model and Command Processing

The block diagram in the figure below shows how SCPI commands are serviced in the instrument. The individual components work independently and simultaneously. They communicate with each other by means of so-called "messages".

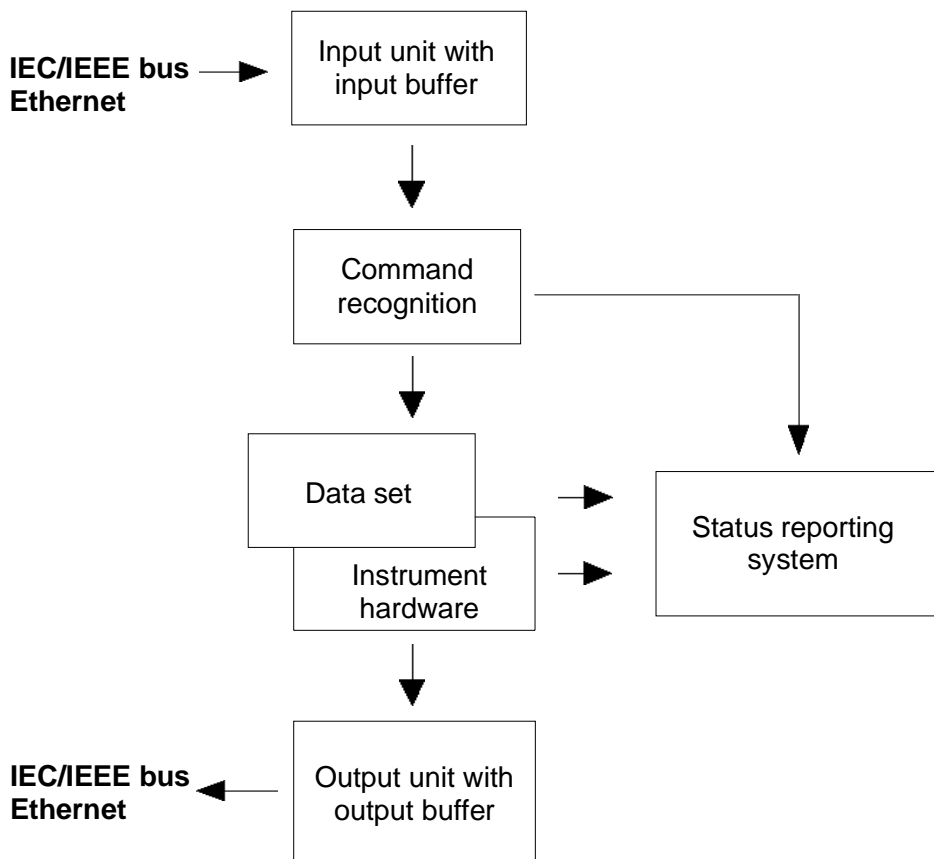

Figure 5-2 Instrument model in the case of remote control via IEC/IEEE bus or TCP/IP network

### Input Unit

The input unit receives commands character by character from the IEC/IEEE bus or via the Ethernet and collects them in the input buffer. The input unit sends a message to the command recognition as soon as the input buffer is full or as soon as it receives a delimiter, <PROGRAM MESSAGE TERMINATOR>, as defined in IEEE 488.2, or the interface message DCL.

If the input buffer is full, the traffic is stopped and the data received up to then is processed. Subsequently the traffic is continued. If, however, the buffer is not yet full when receiving the delimiter, the input unit can already receive the next command during command recognition and execution. The receipt of a DCL clears the input buffer and immediately initiates a message to the command recognition.

## Command Recognition

The command recognition analyses the data received from the input unit. It proceeds in the order in which it receives the data. Only a DCL is serviced with priority, a GET (Group Execute Trigger), e.g., is only executed after the commands received before. Each recognized command is immediately transmitted to the data set but not executed immediately.

The command recognition detects syntax errors in the commands and transfers them to the status reporting system. The rest of a command line after a syntax error is analyzed further if possible and serviced. After the syntax test, the value range of the parameter is checked, if required.

If the command recognition detects a delimiter or a DCL, it also requests the data set to perform the necessary instrument hardware settings. Subsequently it is immediately prepared to process further commands. This means that new commands can already be serviced while the hardware is still being set ("overlapping execution").

## Data Base and Instrument Hardware

The expression "instrument hardware" denotes the part of the instrument fulfilling the actual instrument function - signal generation etc. The controller is not included. The term "database" denotes a database that manages all the parameters and associated settings required for setting the instrument hardware.

Setting commands lead to an alteration in the data set. The data set management enters the new values (e.g. frequency) into the data set, however, only passes them on to the hardware when requested by the command recognition. As this is only ever effected at the end of a command line, the order of the setting commands in the command line is not relevant.

The data are only checked for their compatibility among each other and with the instrument hardware immediately before they are transmitted to the instrument hardware. If the detection is made that execution is not possible, an "execution error" is signaled to the status reporting system. All alterations of the data set are canceled, the instrument hardware is not reset. Due to the delayed checking and hardware setting, however, impermissible instrument states can be set for a short period of time within one command line without this leading to an error message. At the end of the command line, however, a permissible instrument state must have been reached again.

### Example:

With **Custom Digital Modulation**, the settable FSK deviation depends on the set symbol rate (in case of FSK modulation). The R&S SMATE responds as follows:

Assuming the set symbol rate is 100 ksymb/s, i.e. the permissible value range for FSK deviation is 1 kHz to 150 kHz. A deviation of 300 kHz should be set. To do so, the symbol rate has to be changed to 150 ksymb/s. The following commands are sent:

1. All commands in one program message:

```
:SOUR:BB:DM:FORM FSK2; :SOUR:BB:DM:FSK:DEV 300kHz; :SOUR:BB:DM:SRAT  
150kHz
```

This command line yields the desired setting. Since a valid state is obtained at the end of the program message, no error message is issued.

2. Each command in a separate program message:

```
:SOUR:BB:DM:FORM FSK2  
:SOUR:BB:DM:FSK:DEV 300kHz  
:SOUR:BB:DM:SRAT 150kHz
```

The command for setting the FSK deviation is rejected and an execution error is generated. At the time when this command is processed, the previous setting of the symbol rate (100 ksymb) is still valid, i.e. the value for the FSK deviation is outside the permissible value range. The two other commands are set.

3. The two first commands in one program message, the third command in a separate program message.

```
:SOUR:BB:DM:FORM FSK2; :SOUR:BB:DM:FSK:DEV 300kHz  
:SOUR:BB:DM:SRAT 150kHz
```

The command for setting the FSK deviation is rejected and an execution error is generated. At the time when this command is processed, the previous setting of the symbol rate (100 ksymb) is still valid, i.e. the value for the FSK deviation is outside the permissible value range. The two other commands are executed.

This example shows that it is advisable to send interdependent commands in one program message as in this case the sequence in which they are sent is irrelevant.

Queries induce the data set management to send the desired data to the output unit.

## Status Reporting System

The status reporting system collects information on the instrument state and makes it available to the output unit on request. The exact structure and function are described in section "[Status Reporting System](#)", page 5.22.

## Output Unit

The output unit collects the information requested by the controller, which it receives from the data set management. It processes it according to the SCPI rules and makes it available in the output buffer. If the instrument is addressed as a talker without the output buffer containing data or awaiting data from the data set management, the output unit sends the error message "Query UNTERMINATED" to the status reporting system. No data are sent on the IEC/IEEE bus or via the Ethernet, the controller waits until it has reached its time limit. This behavior is specified by SCPI.

## Command Sequence and Command Synchronization

What was said above makes clear that overlapping execution is possible in principle for all commands. Equally, setting commands within one command line are not absolutely serviced in the order in which they have been received.

In order to make sure that commands are actually carried out in a certain order, each command must be sent in a separate command line. In order to prevent an overlapping execution of commands, one of commands \*OPC, \*OPC? or \*WAI must be used. All three commands cause a certain action only to be carried out after the hardware has been set and has settled. By suitable programming, the controller can be forced to wait for the respective action to occur (see table).

Table 5-1 Synchronization with \*OPC, \*OPC? and \*WAI

Command	Action	Programming the controller
*OPC	Sets the Operation Complete bit in the ESR after all previous commands have been executed.	- Setting bit 0 in the ESE - Setting bit 5 in the SRE - Waiting for service request (SRQ)
*OPC?	Stops command processing until 1 is returned. This is only the case after the Operation Complete bit has been set in the ESR. This bit indicates that the previous setting has been completed.	Sending *OPC? directly after the command whose processing should be terminated before other commands can be executed.
*WAI	Stops further command processing until all commands sent before *WAI have been executed.	Sending *WAI directly after the command whose processing should be terminated before other commands are executed.

## Status Reporting System

The status reporting system (cf. Figure 5-3) stores all information on the present operating state of the instrument, and on errors which have occurred. This information is stored in the status registers and in the error queue. The status registers and the error queue can be queried via IEC/IEEE bus or via the Ethernet .

The information is of a hierarchical structure. The register status byte (STB) defined in IEEE 488.2 and its associated mask register service request enable (SRE) form the uppermost level. The STB receives its information from the standard event status register (ESR) which is also defined in IEEE 488.2 with the associated mask register standard event status enable (ESE) and registers STATus:OPERation and STATus:QUEStionable which are defined by SCPI and contain detailed information on the instrument.

The IST flag ("Individual STatus") and the parallel poll enable register (PPE) allocated to it are also part of the status reporting system. The IST flag, like the SRQ, combines the entire instrument status in a single bit. The PPE fulfills an analog function for the IST flag as the SRE for the service request.

The output buffer contains the messages the instrument returns to the controller. It is not part of the status reporting system but determines the value of the MAV bit in the STB.



## Overview of the Status Register

The following figure shows the status registers used in the R&S SMATE.

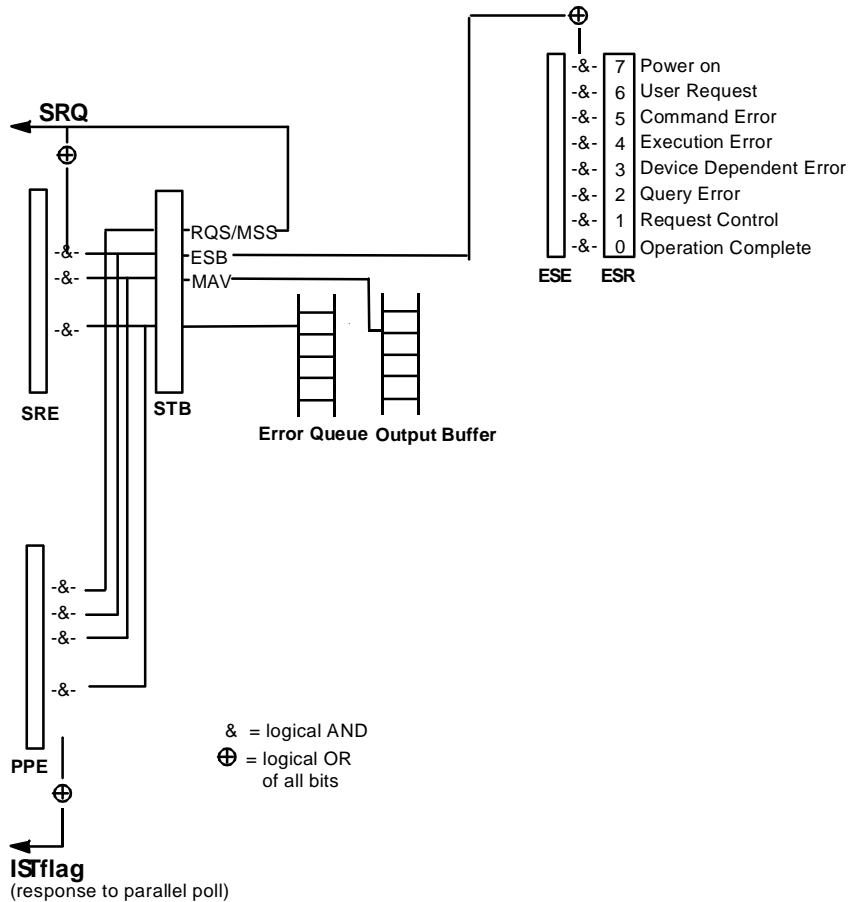

Figure 5-3 Overview of status registers

## Status Byte (STB) and Service Request Enable Register (SRE)

The STB is already defined in IEEE 488.2. It provides a rough overview of the instrument status by collecting the pieces of information of the lower registers. A special feature is that bit 6 acts as the sum bit of the remaining bits of the status byte.

The STATUS BYTE is read out using the command "`*STB?`" or a serial poll.

The STB is linked to the SRE. Each bit of the STB is assigned a bit in the SRE. Bit 6 of the SRE is ignored. If a bit is set in the SRE and the associated bit in the STB changes from 0 to 1, a Service Request (SRQ) is generated on the IEC/IEEE bus or via the Ethernet, which triggers an interrupt in the controller if this is appropriately configured and can be further processed there.

The SRE can be set using command "`*SRE`" and read using "`*SRE?`".

Table 5-2 Meaning of the bits used in the status byte

Bit no.	Meaning
0...1	Not used
2	<p><b>Error Queue not empty</b></p> <p>The bit is set when an entry is made in the error queue. If this bit is enabled by the SRE, each entry of the error queue generates a Service Request. Thus an error can be recognized and specified in greater detail by polling the error queue. The poll provides an informative error message. This procedure is to be recommended since it considerably reduces the problems involved with Remote control.</p>
3	Not used
4	<p><b>MAV bit (Message available)</b></p> <p>The bit is set if a message is available in the output buffer which can be read. This bit can be used to enable data to be automatically read from the instrument to the controller.</p>
5	<p><b>ESB bit</b></p> <p>Sum bit of the event status register. It is set if one of the bits in the event status register is set and enabled in the event status enable register. Setting of this bit indicates a serious error which can be specified in greater detail by polling the event status register.</p>
6	<p><b>MSS bit (Master-Status-Summary-Bit)</b></p> <p>The bit is set if the instrument triggers a service request. This is the case if one of the other bits of this register is set together with its mask bit in the service request enable register SRE.</p>
7	Not used

## IST-Flag and Parallel Poll Enable Register (PPE)

By analogy with the SRQ, the IST flag combines the entire status information in a single bit. It can be queried by means of a parallel poll (cf. Section "[Parallel Poll](#)", page 5.26") or using the command "\*IST?".

The parallel poll enable register (PPE) determines which bits of the STB contribute to the IST flag. The bits of the STB are ANDed with the corresponding bits of the PPE, with bit 6 being used as well in contrast to the SRE. The IST flag results from the ORing of all results. The PPE can be set using commands "PRE" and read using command "PRE?".

## Event Status Register (ESR) and Event Status Enable Register (ESE)

The ESR is defined in IEEE 488.2. The event status register can be read out using command "ESR?". The ESE is the associated ENABLE part. It can be set using the command "ESE" and read using the command "ESE?".

Table 5-3 Meaning of the bits used in the event status register

Bit No.	Meaning
0	<p><b>Operation Complete</b></p> <p>This bit is set on receipt of the command *OPC exactly when all previous commands have been executed.</p>
1	not used
2	<p><b>Query Error</b></p> <p>This bit is set if either the controller wants to read data from the instrument without having sent a query, or if it does not fetch requested data and sends new instructions to the instrument instead. The cause is often a query which is faulty and hence cannot be executed.</p>
3	<p><b>Device-dependent Error</b></p> <p>This bit is set if a device-dependent error occurs. An error message with a number between -300 and -399 or a positive error number, which denotes the error in greater detail, is entered into the error queue.</p>
4	<p><b>Execution Error</b></p> <p>This bit is set if a received command is syntactically correct but cannot be performed for other reasons. An error message with a number between -200 and -300, which denotes the error in greater detail, is entered into the error queue.</p>
5	<p><b>Command Error</b></p> <p>This bit is set if a command which is undefined or syntactically incorrect is received. An error message with a number between -100 and -200, which denotes the error in greater detail, is entered into the error queue.</p>
6	<p><b>User Request</b></p> <p>This bit is set on pressing the <b>LOCAL</b> key, i.e., when the instrument is switched over to manual control.</p>
7	<p><b>Power On</b> (supply voltage on)</p> <p>This bit is set on switching on the instrument.</p>

## Application of the Status Reporting System

In order to effectively use the status reporting system, the information contained there must be transmitted to the controller and further processed. There are several methods, which are outlined in the following.

### Service Request

Under certain circumstances, the instrument can send a service request (SRQ) to the controller. Usually this service request initiates an interrupt at the controller, to which the control program can react appropriately. As evident from section "[Overview of the Status Register](#)", page 5.23, an SRQ is always initiated if one or several of bits 2, 4 or 57 of the status byte are set and enabled in the SRE. Each of these bits combines the information of a further register, the error queue or the output buffer. In order to use the possibilities of the service request effectively, all bits should be set to "1" in the enable registers SRE and ESE.

Example:

Use command "`*OPC`" to generate an SRQ

- `CALL IBWRT(generator%, "*ESE 1")` set bit 0 of ESE (Operation Complete)
- `CALL IBWRT(generator%, "*SRE 32")` set bit 5 of SRE (ESB)

After its settings have been completed, the instrument generates an SRQ.

The SRQ is the only possibility for the instrument to become active on its own. Each controller program should set the instrument such that a service request is initiated in the case of malfunction. The program should react appropriately to the service request.

### Serial Poll

In a serial poll, just as upon the command "`*STB`", the status byte of an instrument is queried. However, the query is made via interface messages and is thus clearly faster. The serial-poll method has already been defined in IEEE 488.1 and used to be the only standard possibility for different instruments to poll the status byte. The method also works for instruments which do not adhere to SCPI or IEEE 488.2.

The VISUAL BASIC command for executing a serial poll is "`IBRSP()`". The serial poll is mainly used to obtain a fast overview of the state of several instruments connected to the IEC/IEEE bus or via the Ethernet.

### Parallel Poll

In a parallel poll, the controller uses a single command to request up to eight instruments to transmit one bit of information each on the data lines, i.e., to set the data line allocated to each instrument to a logical "0" or "1". In addition to the SRE register, which determines the conditions under which an SRQ is generated, there is a parallel poll enable register (PPE). This register is ANDed with the STB bit by bit, considering bit 6 as well. The results are ORed, the result is possibly inverted and then sent as a response to the parallel poll of the controller. The result can also be queried without parallel poll by means of the command "`*IST?`".

The instrument first has to be set for the parallel poll using the VISUAL BASIC command "`IBPPC()`". This command allocates a data line to the instrument and determines whether the response is to be inverted. The parallel poll itself is executed using "`IBRPP()`".

The parallel poll method is mainly used to find out quickly which one of the instruments connected to the IEC/IEEE bus has sent a service request. To this effect, SRE and PPE must be set to the same value.

## Query by Means of Commands

Each part of any status register can be read by means of queries. The individual commands are listed in the description of the STATus Subsystem. The returned value is always a number that represents the bit pattern of the register queried. This number is evaluated by the controller program.

Queries are usually used after an SRQ in order to obtain more detailed information on the cause of the SRQ.

## Error Queue Query

Each error state in the instrument leads to an entry in the error queue. The entries of the error queue are detailed plain-text error messages that can be looked at in the ERROR menu via manual control or queried via the IEC/IEEE bus or via the Ethernet using command "SYSTem:ERRor?". Each call of "SYSTem:ERRor?" provides one entry from the error queue. If no error messages are stored there any more, the instrument responds with 0, "No error".

The error queue should be queried after every SRQ in the controller program as the entries describe the cause of an error more precisely than the status registers. Especially in the test phase of a controller program the error queue should be queried regularly since faulty commands from the controller to the instrument are recorded there as well.

## Reset Values of the Status Reporting Systems

Commands \*RST, \*DCL and SYSTem:PRESet and switching on the supply voltage also affect the status reporting system. None of the commands, except for \*RST and SYSTem:PRESet influences the functional instrument settings. In particular, DCL does not change the instrument settings.

Table 5-4 Resetting the Status Reporting System

Event	Switching on supply voltage		DCL,SDC (Device Clear, Selected Device Clear)	*RST or SYSTem:PRESet	STATus:PRESet	*CLS
	Power-On-Status-Clear					
Effect	0	1				
Clear STB,ESR	–	yes	–	–	–	yes
Clear SRE,ESE	–	yes	–	–	–	–
Clear PPE	–	yes	–	–	–	–
Clear error-queue	yes	yes	–	–	–	yes
Clear output buffer	yes	yes	yes	1)	1)	1)
Clear command processing and input buffer	yes	yes	yes	–	–	–

1) Every command being the first in a command line, i.e. immediately following a <PROGRAM MESSAGE TERMINATOR> clears the output buffer

## Remote Control Hardware Interfaces

The following section describes the remote-control interfaces of the signal generator.

All other interfaces are described in Chapter 1, sections "Legend for Front Panel View" and "Legend for Rear Panel View". For specifications refer to the data sheet.

### IEC/IEEE Bus Interface

The standard instrument is equipped with an IEC/IEEE bus connector. An IEEE 488 interface connector is located on the rear panel. An external controller for remote control of the instrument can be connected via the IEEE 488 interface connector using a shielded cable.

#### Interface Characteristics

- 8-bit parallel data transfer
- bi-directional data transfer
- three-line handshake
- high data transfer rate
- up to 15 instruments can be connected
- maximal length of the interconnecting cables 15 m (single connection, 2m)
- wired-OR connection if several instruments are connected in parallel.

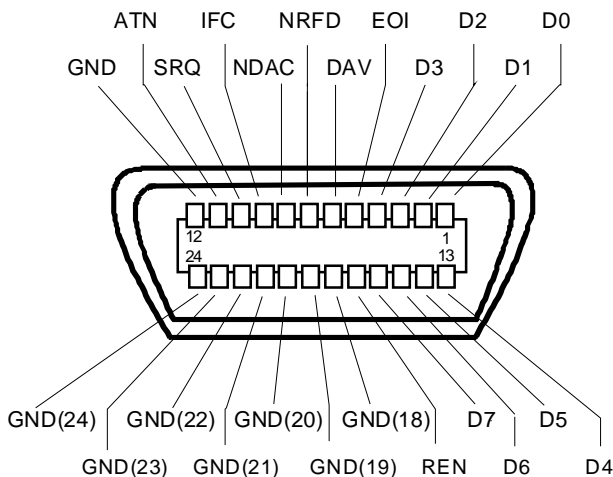

Figure 5-4 Pin assignment of IEC/IEEE-Bus interface

#### Bus Lines

##### 1. Data bus with 8 lines D0 to D7.

The transmission is bit-parallel and byte-serial in the ASCII/ISO code. D0 is the least significant bit, D7 the most significant bit.

## 2. Control bus with 5 lines

<b>IFC</b> (Interface Clear)	active LOW resets the interfaces of the instruments connected to the default setting.
<b>ATN</b> (Attention)	active LOW signals the transmission of interface messages. inactive HIGH signals the transmission of device messages.
<b>SRQ</b> (Service Request)	active LOW enables the connected device to send a service request to the controller.
<b>REN</b> (Remote Enable)	active LOW permits switchover to remote control.
<b>EOI</b> (End or Identify)	has two functions in connection with ATN: ATN = HIGH active LOW marks the end of data transmission. ATN = LOW active LOW triggers a parallel poll.

## 3. Handshake bus with three lines

<b>DAV</b> (Data Valid)	active LOW signals a valid data byte on the data bus.
<b>NRFD</b> (Not Ready For Data)	active LOW signals that one of the connected devices is not ready for data transfer.
<b>NDAC</b> (Not Data Accepted)	active LOW signals that the instrument connected is accepting the data on the data bus.

## IEC/IEEE-Bus Interface Functions

Instruments which can be remote controlled via the IEC/IEEE bus can be equipped with different interface functions. The following table lists the interface functions appropriate for the instrument.

Table 5-5 IEC/IEEE Bus Interface functions

Control character	Interface function
SH1	Handshake source function (source handshake), full capability
AH1	Handshake sink function (acceptor handshake), full capability
L4	Listener function, full capability, unaddress if MTA.
T6	Talker function, full capability, ability to respond to serial poll, unaddress if MLA
SR1	Service request function (Service Request), full capability
PP1	Parallel poll function, full capability
RL1	Remote/Local switch over function, full capability
DC1	Reset function (Device Clear), full capability
DT1	Trigger function (Device Trigger), full capability
C0	No controller function

## IEC/IEEE Bus Messages

Interface messages are transferred on the data lines of the IEC/IEEE bus when the "ATN" control line is active (LOW). They are used for communication between controller and instruments and can only be sent by the controller which currently has control of the IEC/IEEE bus.

### Universal Commands

The universal commands are encoded 10 - 1F hex. They affect all instruments connected to the bus without addressing.

Table 5-6 Universal Commands

Command	VISUAL BASIC command	Effect on the instrument
DCL (Device Clear)	IBCMD (controller%, CHR\$(20))	Aborts the processing of the commands just received and sets the command processing software to a defined initial state. Does not change the instrument settings..
IFC (Interface Clear)	IBSIC (controller%)	Resets the interfaces to the default setting.
LLO (Local Lockout)	IBCMD (controller%, CHR\$(17))	Locks switchover from remote control to manual control by means of the front panel keys
SPE (Serial Poll Enable)	IBCMD (controller%, CHR\$(24))	Ready for serial poll.
SPD (Serial Poll Disable)	IBCMD (controller%, CHR\$(25))	End of serial poll.
PPU (Parallel Poll Unconfigure)	IBCMD (controller%, CHR\$(21))	End of the parallel-poll state.

### Addressed Commands

The addressed commands are encoded 00 - 0F hex. They are only effective for instruments addressed as listeners.

Table 5-7 Addressed Commands

Command	VISUAL BASIC Command	Effect on the instrument
SDC (Selected Device Clear)	IBCLR (device%)	Aborts the processing of the commands just received and sets the command processing software to a defined initial state. Does not change the instrument setting.
GET (Group Execute Trigger)	IBTRG (device%)	Triggers a previously active device function (eg a sweep). The effect of the command is the same as with that of a pulse at the external trigger signal input.
GTL (Go to Local)	IBLOC (device%)	Transition to the "Local" state (manual control).
PPC (Parallel Poll Configure)	IBPPC (device%, data%)	Configures instrument for parallel poll. Additionally, the VISUAL BASIC command executes PPE/PPD.



## LAN Connector

The unit is equipped with an LAN interface as standard. The LAN connector is at the rear of the instrument. Provided the appropriate rights have been assigned by the network administrator, files can be transmitted via the network, and network resources, e.g. a network folders, can be used. The instrument can also be remote-controlled and manually operated in the network. It is connected by means of a commercial RJ45 cable.

The network card functions with 10/100/1000Mbps Ethernet IEEE 802.3u. The TCP/IP network protocol and the associated network services are preconfigured. TCP/IP ensures connection-oriented communication, where the order of the exchanged messages is adhered to and interrupted links are identified. With this protocol, messages cannot be lost.

Connection of the R&S SMATE is described in Chapter 1, Section "[Connecting the R&S SMATE to a Network \(LAN\)](#)", on page 1.20", remote control via Ethernet in section "[Remote Control via LAN Interface](#)", page 5.5. The architecture of a LAN remote-control connection is described in detail in the following.

Remote control of an instrument via a network is based on standardized protocols which follow the OSI reference model (see Fig. below).

Application	SCPI	SCPI [3]
Presentation	XDR (VXI-11)	RFC 1014 [1,2]
Session	ONC-RPC	RFC 1057
Transport	TCP / UDP	RFC 793
Network	IP	RFC 791
Data Link	Ethernet/802.3	8802-3
Physical	802.3/10BASE-T	8802-3

Fig. 5-5 Example for LAN remote control based on the OSI reference model

Based on TCP/UDP, messages between the controller and the instrument are exchanged via open network computing (ONC) - remote procedure calls (RPC). With XDR, legal RPC messages are known as VXI-11 standard. Based on this standard, messages are exchanged between the controller and the instrument. The messages are identical with SCPI commands. They can be organized in four groups: program messages (control command to the instrument), response messages (values returned by the instrument), service request (spontaneous queries of the instrument) and low-level control messages (interface messages).

A VXI-11 link between a controller and an instrument uses three channels: a core, abort and interrupt channel. Instrument control is mainly performed on the core channel (program, response and low-level control messages). The abort channel is used for immediate abort of the core channel; the interrupt channel transmits spontaneous service requests of the instrument. Link setup itself is very complex. For more details refer to the VXI-11 specification ("TCP/IP Instrument Protocol Specification VXI-11, Revision 1.0 VMEbus Extensions for Instrumentation, VXIbus", and "TCP/IP-IEEE 488.2 Instrument Interface Specification VXI-11.3, Draft 0.3 VMEbus Extensions for Instrumentation, VXIbus").

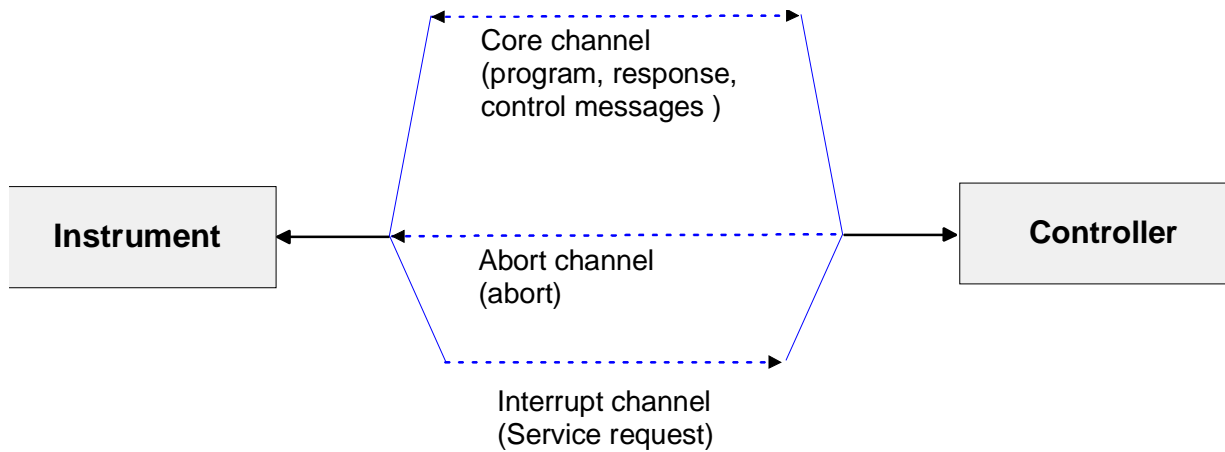

Fig. 5-6 VXI-11 channels between instrument and controller

The number of controllers that can address an instrument is practically unlimited in the network. In the instrument, the individual controllers are clearly distinguished. This distinction continues up to the application level in the controller, i.e. two applications on a PC are identified by the instrument as two different controllers.

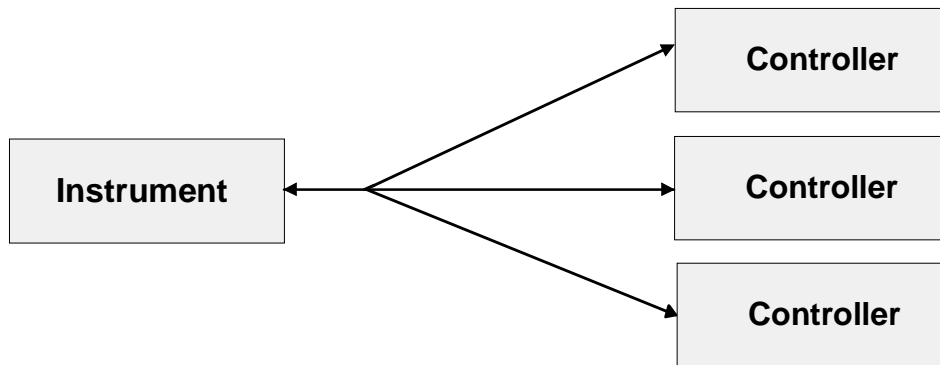
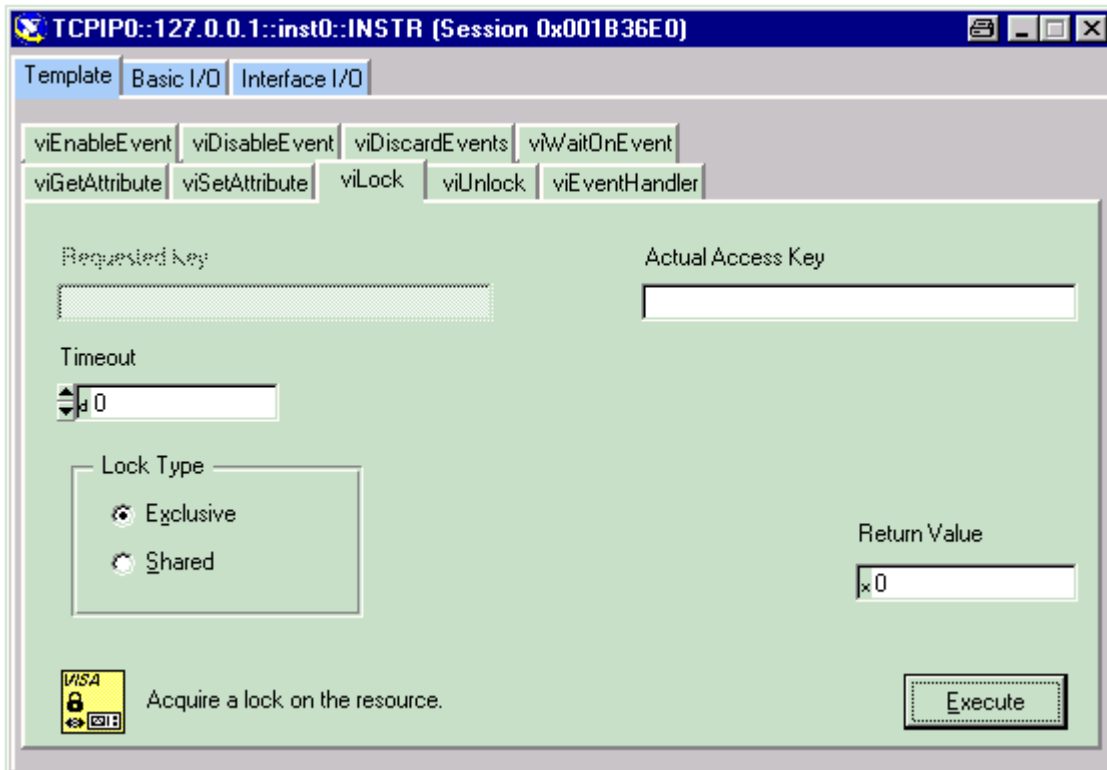

Fig. 5-7 Remote control via LAN from several controllers

The controllers can lock and unlock the instrument for exclusive access. This regulates access to the instrument of several controllers.

In the '**Measurement & Automation Control**' program, this setting is made on the **Template** tab.



### VXI-11 Interface Messages

On the Ethernet link, the interface messages are called low-level control messages. These messages can be used to emulate interface messages of the IEC/IEEE bus.

Table 5-8 VXI-11 Interface Messages

Command	Effect on the instrument
&ABO (Abort)	Aborts the processing of the commands just received.
&DCL (Device Clear)	Aborts the processing of the commands just received and sets the command processing software to a defined initial state. Does not change the instrument setting.
&GTL (Go to Local)	Transition to the "Local" state (manual control)
&GTR (Go to Remote)	Transition to the "Remote" state (remote control)
&GET (Group Execute Trigger)	Triggers a previously active device function (eg a sweep). The effect of the command is the same as with that of a pulse at the external trigger signal input.
&LLO (Local Lockout)	Disables switchover from remote control to manual control by means of the front panel keys
&POL (Serial Poll)	Starts a serial poll
&NREN (Not Remote Enable)	Enables switchover from remote control to manual control by means of the front panel keys



## Contents - Chapter 6 "Remote Control - Description of Commands"

<b>Remote-Control - Description of Commands .....</b>	<b>6.1</b>
Notation .....	6.1
Common Commands.....	6.4
Preset Commands.....	6.7
CALibration Subsystem .....	6.8
CLOCK Subsystem .....	6.11
DIAGnostic Subsystem .....	6.13
FORMat Subsystem .....	6.16
MMEMory Subsystem .....	6.18
OUTPut Subsystem.....	6.26
SENSe and READ Subsystem.....	6.31
SOURce Subsystem.....	6.36
SOURce:AM Subsystem .....	6.36
SOURce:AWGN Subsystem .....	6.40
SOURce:BB Subsystem.....	6.48
SOURce:BB:ARB Subsystem .....	6.51
R&S Vector Signal Generator Waveform and List Format.....	6.88
Creating a Waveform Manually .....	6.94
SOURce:BB:C2K-Subsystem .....	6.99
SOURce:C2K - Primary Commands .....	6.101
SOURce:BB:C2K - Predefined Settings.....	6.122
SOURce:BB:C2K - Setting Base Stations.....	6.128
SOURce:BB:C2K - Mobile Station Settings .....	6.158
SOURce:BB:DM Subsystem .....	6.172
DM General Remote-Control Commands .....	6.172
DM Lists - Remote-Control Commands .....	6.195
SOURce:BB:GPS Subsystem .....	6.206
SOURce-GPS - Primary Commands .....	6.206
SOURce-GPS - Satellite Signal Settings .....	6.226
SOURce:BB:GSM Subsystem .....	6.238
SOURce:BB:IMPairment Subsystem .....	6.276
SOURce:BB:MCCW Subsystem .....	6.280
SOURce:BB:POWer Subsystem.....	6.301
SOURce:BB:TDSCdma-Subsystem.....	6.303
SOURce:TDSCdma - Primary Commands .....	6.305
SOURce:BB:TDSCdma - Predefined Settings.....	6.325
SOURce:BB:TDSCdma – Cell Settings .....	6.328
SOURce:BB:TDSCdma – Enhanced Channels of Cell 1.....	6.331
SOURce:BB:TDSCdma – Channel Settings .....	6.347
SOURce:BB:WIMax Subsystem .....	6.364
SOURce-WIMax - Primary Commands.....	6.366
SOURce-WIMax - OFDMA Physical Layer Settings .....	6.387
SOURce-WIMax - OFDM Physical Layer Settings .....	6.415
SOURce:BB:WLAN Subsystem .....	6.435
SOURce:WLAN - Primary Commands.....	6.437

SOURce:WLAN - PSDU Settings.....	6.460
SOURce:BB:W3GPP Subsystem .....	6.470
SOURce:W3GPP - Test Models and Predefined Settings .....	6.492
SOURce:W3GPP - Setting Base Stations .....	6.498
SOURce:W3GPP - Enhanced Channels of Base Station 1 .....	6.533
SOURce:W3GPP - User Equipment Settings .....	6.555
SOURce:W3GPP - Enhanced Channels of the User Equipment....	6.608
SOURce:W3GPP - TS25141 - Test Wizard .....	6.625
SOURce:CORRection Subsystem .....	6.655
SOURce:FM Subsystem .....	6.664
SOURce:FREQUency Subsystem.....	6.667
SOURce:INPut Subsystem .....	6.674
SOURce:IQ Subsystem - I/Q Modulation.....	6.677
SOURce:IQ:OUTPut Subsystem - Differential Outputs .....	6.681
SOURce:LFOutput Subsystem .....	6.684
SOURce:LIST Subsystem.....	6.690
SOURce:MODulation Subsystem .....	6.704
SOURce:PATH Subsystem.....	6.705
SOURce:PHASe Subsystem.....	6.706
SOURce:PM Subsystem .....	6.707
SOURce:POWer Subsystem.....	6.710
SOURce:PULM Subsystem .....	6.718
SOURce:ROSCillator Subsystem .....	6.720
SOURce:SWEEP Subsystem .....	6.722
STATus Subsystem.....	6.729
SYSTem Subsystem .....	6.733
TEST Subsystem.....	6.739
TRIGger Subsystem.....	6.740
UNIT Subsystem .....	6.745

# Remote-Control - Description of Commands

In the following, all remote-control commands will be presented in detail with their parameters and the ranges of numerical values.

An introduction to remote control and the status registers is given in chapter 5.

## Notation

All commands implemented in the instrument are first listed in tables and then described in detail, arranged alphabetically according to the command subsystems. The notation is adapted to the SCPI standard. The SCPI conformity information is included in the individual description of the commands.

### Table of Commands

**Command:** In the command column, the table provides an overview of the commands.

**Parameter:** The parameter column indicates the requested parameters together with their specified range.

**Unit:** The unit column indicates the basic unit of the physical parameters.

**Remark:** In the remark column an indication is made on:

- whether the command does not have a query form,
- whether the command has only one query form

**Individual description** The individual description contains the complete notation of the command. An example for each command, the \*RST value and the SCPI information are included as well.

The options that are required to execute the command are listed. In case of dependencies between commands they are also indicated.

**Upper/lower case notation** Upper/lower case letters are used to mark the long or short form of the key words of a command in the description (see Chapter 5). The instrument itself does not distinguish between upper and lower case letters.

**Special characters |** A selection of key words with an identical effect exists for several commands. These keywords are indicated in the same line; they are separated by a vertical stroke. Only one of these keywords needs to be included in the header of the command. The effect of the command is independent of which of the keywords is used.

**Example:** `SOURce:FREQuency:CW|:FIXed`

The two following commands with identical meaning can be created. They set the frequency of the fixed frequency signal to 1 kHz

```
SOURce:FREQuency:CW 1E3 = SENSE:FREQuency:FIXed 1E3
```

A vertical stroke in parameter indications marks alternative possibilities in the sense of "or". The effect of the command is different, depending on which parameter is used.

Example: Selection of the parameters for the command

```
SOURce:COUPling AC | DC
```

If parameter AC is selected, only the AC content is fed through, in the case of DC, the DC as well as the AC content.

- [ ] Key words in square brackets can be omitted when composing the header (cf. Chapter 5, Optional Keywords). The full command length must be accepted by the instrument for reasons of compatibility with the SCPI standards.

Parameters in square brackets can be incorporated optionally in the command or omitted as well.

- { } Parameters in braces can be incorporated optionally in the command, either not at all, once or several times..

**Description of parameters** Due to the standardization, the parameter section of SCPI commands consists always of the same syntactical elements. SCPI has therefore specified a series of definitions, which are used in the tables of commands. In the tables, these established definitions are indicated in angled brackets (<...>) and will be briefly explained in the following (see also Chapter 5, Section "Parameters").

<Boolean> This keyword refers to parameters which can adopt two states, "on" and "off". The "off" state may either be indicated by the keyword **OFF** or by the numeric value 0, the "on" state is indicated by **ON** or any numeric value other than zero. Parameter queries are always returned the numeric value 0 or 1.

<numeric\_value>

<num>

These keywords mark parameters which may be entered as numeric values or be set using specific keywords (character data).



The following keywords given below are permitted:

MINimum This keyword sets the parameter to the smallest possible value.

MAXimum This keyword sets the parameter to the largest possible value.

DEFault This keyword is used to reset the parameter to its default value.

UP This keyword increments the parameter value.

DOWN This keyword decrements the parameter value.

The numeric values associated to MAXimum/MINimum/DEFault can be queried by adding the corresponding keywords to the command. They must be entered following the quotation mark.

Example: `SOURce:FREQuency? MAXimum`

eturns the maximum possible numeric value of the center frequency as result.

<arbitrary block program data>

This keyword is provided for commands the parameters of which consist of a binary data block.

## Common Commands

The common commands are taken from the standard IEEE 488.2 (IEC 625.2). Identical commands have an identical effect in different instruments. The headers of these commands consist of an asterisk "\*" followed by three letters. Many common commands affect the status reporting system, which is described in detail in Chapter 5.

Command	Parameters	Default unit	Remark
*CLS			Clear status; no query
*ESE	0...255		Event status enable
*ESR?	0...255		Standard event status query; query only
*IDN?			Identification query; query only
*IST?	0...255		Individual status query; query only
*OPC			Operation complete
*OPT?			Option identification query; query only
*PRE	0...255		Parallel poll register enable
*PSC	0   1		Power on status clear
*RCL	1...10		Recall
*RST			Reset; no query
*SAV	1...10		Save
*SRE	0...255		Service request enable
*STB?			Status byte query; query only
*TRG			Trigger; no query
*TST?			Self test query; query only
*WAI			Wait to continue; no query

### \*CLS

**CLEAR STATUS** sets the status byte (STB), the standard event register (ESR), and the EVENT part of the QUESTIONABLE and OPERATION register to zero. The command does not change the enable and transition parts of the registers. It deletes the output buffer.

### \*ESE 0...255

**EVENT STATUS ENABLE** sets the event status enable register to the specified value. The \*ESE? query command returns the content of the event status enable register in decimal form.

### \*ESR?

**STANDARD EVENT STATUS QUERY** returns the content of the event status register in decimal form (0...255) and then sets the register to zero.

**\*IDN?**

**IDENTIFICATION QUERY** queries the instrument identification. The instrument type, serial number and firmware version are returned. Example:

Rohde&Schwarz, SMATE200A, 1141.2005k02/000000,1.45.0.3-01.06.05 (Release)

**\*IST?**

**INDIVIDUAL STATUS QUERY** returns the content of the IST flag in decimal form (0 | 1). The IST flag is the status bit which is sent during a parallel poll.

**\*OPC**

**OPERATION COMPLETE** sets bit 0 in the event status register when all previous commands have been processed. This bit can be used to trigger a service request.

**\*OPC?**

**OPERATION COMPLETE QUERY** returns a 1 when all previous commands have been processed. It is important to ensure that the timeout set at the IEC/IEEE bus is long enough.

**\*OPT?**

**OPTION IDENTIFICATION QUERY** queries the options configured in the instrument and returns a list of the installed options. The options are separated by commas.

**\*PRE 0 ... 255**

**PARALLEL POLL REGISTER ENABLE** sets the parallel poll enable register to the specified value. The \*PRE? query command returns the content of the parallel poll enable register in decimal form.

**\*PSC 0 | 1**

**POWER ON STATUS CLEAR** determines whether the content of the ENABLE registers are retained or reset at power on.

**Parameters:**      **0**

The content of the status registers is retained at power on. If the status registers ESE and SRE are configured accordingly, this may cause a service request to be triggered at power on.

**1**

The content of the status registers is reset at power on.

The **query** \*PSC? retrieves the contents of the Power-on-Status-Clear flag. The answer is either 0 or 1.

**\*RCL 0...10**

**RECALL** calls up the instrument status which was stored under the specified number using the \*SAV command or using the `MMEMory:STORe:STATe` command. "0" corresponds to the power-on state, unless a new instrument setting was stored under this number in the meantime using the `MMEMory:STORe:STATe` command. This command can also be used to call up the 3 intermediate instrument states which are stored with \*SAV.

**\*RST**

**RESET** resets the instrument to a defined default state. The command has the same effect as pressing the **PRESET** key. The default setting is given in the description of the commands.

**\*RST**

**RESET** resets the instrument to a defined default state. The command has the same effect as pressing the **PRESET** key. The default setting is given in the description of the commands.

Fading and transient recorder are only preset by this command.

**\*SAV**

**SAVE** stores the current device state under the specified number (see also \*RCL). The command is used to store the 3 intermediate instrument states and to store the current instrument state internally when the instrument is switched off. This state is then restored at power on.

**\*SRE 0 ... 255**

**SERVICE REQUEST ENABLE** sets the service request enable register to the specified value. Bit 6 (MSS enable bit) remains 0. This command determines the conditions under which a service request is triggered. The \*SRE? query command reads out the content of the service request enable register in decimal form. Bit 6 is always 0.

**\*STB?**

**READ STATUS BYTE QUERY** reads out the content of the status byte in decimal form.

**\*TRG**

**TRIGGER** triggers all actions which are waiting for a trigger event. Specific trigger events can be triggered by means of the "TRIGger" command system (sweep and lists) or the SOURCE subsystems (baseband).

**\*TST?**

**SELF TEST QUERY** triggers all self tests of the instrument and outputs an error code in decimal form (see Service Manual supplied with the instrument).

**\*WAI**

**WAIT-to-CONTINUE** does not allow subsequent commands to be processed until all previous commands have been executed and all signals are in their transient condition.

# Preset Commands

The preset commands are not bundled in one subsystem. Therefore, they are listed separately in this section. In addition, a specific preset command is provided for each digital standard and for the fader. These specific commands are described in the associated subsystems.

Three presetting actions are available:

1. Activating the default state of all instrument functions (\*RST)
2. Activating the preset state of the parameters related to the selected signal path (SOURce<[1]:2>:PRESet)
3. Activating the preset state of all parameters that are not related to the signal path (DEVIce:PRESet)

Command	Parameters	Default unit	Remark
DEVIce:PRESet			No query
*RST			No query
SOURce<[1]]2>:Preset			No query

## DEVIce:PRESet

The command presets all parameters which are not related to the signal path. This includes presetting the LF generator.

The command triggers an event and therefore has no query form and no \*RST value.

**Example:** "DEV: PRES"  
'presets all instruments settings that are not related to the signal path.

*RST value	Resolution	Options	SCPI
-	-		Device-specific

## \*RST

**RESET** resets the instrument to a defined default state. The command has the same effect as pressing the **PRESET** key. The default setting is given in the description of the commands.

Transient recorder are only preset by this command.

## SOURce<[1]:2>:PRESet

The command presets all parameters which are related to the selected signal path.

Transient recorder are only preset by command \*RST.

The suffix under SOURce distinguishes the paths:

SOURce[1] = path A

SOURce2 = path B

The command triggers an event and therefore has no query form and no \*RST value.

**Example:** "SOUR2: PRES"  
'presets all settings that are related to signal path B.

*RST value	Resolution	Options	SCPI
-	-		Device-specific

## CALibration Subsystem

The CALibration system contains the commands for adjustment. Adjustment is triggered by the query commands. The response "0" indicates error-free adjustment, and the response "1" means that an error occurred during adjustment.

In the case of two-path instruments with a second RF path (option R&S SMATE-B20x), adjustment can be set separately and independently for the two RF paths A and B. The suffix under SOURce distinguishes the outputs:

CALibrate[1] = RF path A

CALibrate2 = RF path B

Command	Parameters	Default unit	Remark
CALibration:ALL[:MEASure]?			Query only
CALibration<[1]2>:FMOffset[:MEASure]?			Query only
CALibration<[1]2>:FREQuency[:MEASure]?			Query only
CALibration<[1]2>:IQModulator:FULL?			Query only
CALibration<[1]2>:IQModulator:LOCal?			Query only
CALibration<[1]2>:LEVel[:MEASure]?			Query only
CALibration<[1]2>:LEVel:STATe	ON   OFF		

### CALibration:ALL[:MEASure]?

The command starts all internal adjustments for which no external measuring equipment is needed.

**Example:** "CAL:ALL:MEAS?"  
'starts the adjustment of all functions for the entire instrument.

Response: "0"  
'adjustment has been performed successfully.

*RST value	Resolution	Options	SCPI
-	-		Compliant

The command starts all adjustment for the FM/PhiM modulator.

**Example:** "CAL:FMOF?"  
'starts the adjustments for the FM/Phim modulator.

Response: "0"  
'the adjustments have been performed successfully.

*RST value	Resolution	Options	SCPI
-	-	Option B22 CALibration2 only with second option B22	Device-specific

**CALibration<[1]2>:FREQUency[:MEASure]?**

The command starts all adjustments which affect the frequency of the selected path.

**Example:** "CAL:FREQ:MEAS?"  
'starts the adjustments for maximum frequency accuracy in Path A.

Response: "0"  
'the adjustments have been performed successfully.

*RST value	Resolution	Options	SCPI
-	-	CALibration2 only with option B20x	Device-specific

**CALibration<[1]2>:IQModulator:FULL?**

The command starts adjustment of the I/Q modulator for the entire frequency range. The I/Q modulator is adjusted with respect to carrier leakage, I/Q imbalance and quadrature.

The command is a query command and therefore has no \*RST value.

**Example:** "CAL:IQM:FULL?"  
'starts adjustments for the I/Q modulator across the entire frequency range.

Response: "0"  
'adjustment has been performed successfully.

*RST value	Resolution	Options	SCPI
-	-	CALibration2 only with option B20x	Device-specific

**CALibration<[1]2>:IQModulation:LOCal?**

The command starts adjustment of the I/Q modulator for the currently set frequency, I/Q swap and baseband gain. The I/Q modulator is adjusted with respect to carrier leakage, I/Q imbalance and quadrature.

The command is a query command and therefore has no \*RST value.

**Example:** "CAL:IQM:LOC?"  
'starts adjustment for the I/Q modulator for the currently set frequency.

Response: "0"  
'adjustment has been performed successfully.

*RST value	Resolution	Options	SCPI
-	-	CALibration2 only with option B20x	Device-specific

**CALibration:LEVel[:MEASure]?**

The command starts all adjustments which affect the level of the selected path.

**Example:** "CAL:LEV:MEAS?"  
 'starts adjustments for maximum level accuracy for Path A.  
 Response: "0"  
 'adjustment has been performed successfully.

*RST value	Resolution	Options	SCPI
-	-	CALibration2 only with option B20x	Device-specific

**CALibration<[1]2>:LEVel:STATe**

The command switches on or off internal level correction.

**Example:** "CAL:LEV:STAT"  
 'switches on Level correction for Path A.

*RST value	Resolution	Options	SCPI
ON	-	CALibration2 only with option B20x	Device-specific



## CLOCK Subsystem

The CLOCK system contains the commands for configuration of the signals at the clock output and input connectors.

Command	Parameters	Default unit	Remark
CLOCK:INPut:FREQuency			Query only
CLOCK:INPut:SLOPe	POSitive   NEGative		
CLOCK:OUTPut:MODE	BIT   SYMBol		
CLOCK:OUTPut:SOURce			Query only

### CLOCK:INPut:FREQuency

The command sets the measured frequency of the external clock signal. An external clock reference must be supplied at the CLOCK input.

The command is a query command and therefore does not have an \*RST value.

**Example:**            "`CLOCK:INP:FREQ?`"  
                          'queries the measured frequency of the external clock reference.

*RST value	Resolution	Options	SCPI
	-	B10/B11 and B13	Device-specific

### CLOCK:INPut:SLOPe POSitive | NEGative

The command sets the active slope of an externally applied clock signal at the CLOCK connector.

**Example:**            "`CLOCK:INP:SLOP NEG`"  
                          'the active slope of the external clock signal at the CLOCK connector is the falling slope.

*RST value	Resolution	Options	SCPI
POSitive	-	B10/B11 and B13	Device-specific

### CLOCK:OUTPut:MODE?

The command sets the output of bit or symbol clock pulses at the CLOCK OUT connector at the rear panel.

**Example:**            "`CLOCK:OUTP:MODE SYMB`"  
                          'the internal symbol clock is output at the CLOCK OUT connector

*RST value	Resolution	Options	SCPI
SYMBol	-	B10/B11 and B13	Device-specific

**CLOCK:OUTPut:SOURce?**

The command queries the path for which the clock signal at the CLOCK OUT connector is to be output.

The command is a query command and therefore does not have an \*RST value.

**Example:** "CLOC:OUTP:SOUR?"  
 'queries the path for which the clock signal at the CLOCK OUT connector is to be output.

Response: A  
 'the clock signal of path is output at the CLOCK OUT connector.

*RST value	Resolution	Options	SCPI
-	-	B10/B11 and B13	Device-specific

## DIAGnostic Subsystem

The DIAGnostic system contains the commands used for instrument diagnosis and servicing. SCPI does not define any DIAGnostic commands; the commands listed here are all Device-specific. All DIAGnostic commands are query commands which are not influenced by \*RST.

In the case of two-path instruments, the numerical suffix under DIAGnostic distinguishes between Path A and Path B:

DIAGnostic[1] = Path A

DIAGnostic2 = Path B

Command	Parameters	Default unit	Remark
DIAGnostic<[1] 2>:BGINfo?	<module name>		Query only
DIAGnostic<[1] 2>:BGINfo:CATalog?			Query only
DIAGnostic:INFO:OTIMe?			Query only
DIAGnostic:INFO:POCounTer?			Query only
DIAGnostic<[1] 2>:POINt:CATalog?			Query only
DIAGnostic<[1] 2>[:MEASure]:POINt?	<point name>		Query only

### DIAGnostic<[1]|2>:BGINfo? <module name>

The command checks the modules available in the instrument using the variant and revision state.

If the command is sent without parameters being specified, a complete list of all modules is returned (the various entries are separated by commas). The length of the list is variable and depends on the instrument equipment configuration.

If the command is sent with parameters, a list of the specified modules is returned (the various entries are separated by commas). A list of modules names can be called up using the `DIAG:BGIN:CATalog?` command.

Each entry for one module consists of four parts which are separated by space characters:

Module name Module stock number incl. variant Module revision Module serial number.

The path for which the query is performed is determined by the numerical suffix.

**Example:**

```
"DIAG:BGIN?"
```

'queries the instrument configuration of Path A.

```
Response: MBRD,SSYN,IQOP3,IQOP3_LCM,....
```

'returns the data of all available modules.

```
"DIAG:BGIN? 'MBRD' "
```

'queries the configuration of the motherboard of Path A.

```
Response: MBRD 1141.3501.02 1.5.3 100023
```

'module motherboard with stock number 1141.3501.01 has revision 1.5.3 and serial number 100023.

*RST value	Resolution	Options	SCPI
-	-	DIAGnostic2 only with option B20x	Device-specific

**DIAGnostic<[1]|2>:BGInfo:CATalog?**

The command queries the names of the assemblies available in the instrument.

A complete list of all assemblies is returned (the various entries are separated by commas). The length of the list is variable and depends on the instrument equipment configuration.

The path for which the query is performed is determined by the numerical suffix.

**Example:** "DIAG2:BGIN:CAT?"  
'queries the names of the assemblies of Path B.

Response: MBRD,SSYN,IQOP3,IQOP3\_LCM,....

*RST value	Resolution	Options	SCPI
-	-	DIAGnostic2 only with option B20x	Device-specific

**DIAGnostic:INFO:OTIME?**

The command queries the number of operation hours

**Example:** "DIAG:INFO:OTIM?"  
'queries the operation hours.

Response: "100023"  
'the instrument was operated for 100023 hours up to now.

*RST value	Resolution	Options	SCPI
-	-		Device-specific

**DIAGnostic:INFO:PCOUNTER?**

The command queries the number of power-on events.

**Example:** "DIAG:INFO:POC?"  
'queries the number of power on events.

Response: "123"  
'the instrument was switched on for 123 times up to now.

*RST value	Resolution	Options	SCPI
-	-		Device-specific

**DIAGnostic<[1]|2>:POINt:CATalog?**

The command queries the test points available in the instrument. A detailed description of the test points can be found in chapter 3, section "Trouble Shooting" of the Service Manual (on CD-ROM, supplied with the instrument).

**Example:** "DIAG:POIN:CAT?"  
 'queries the test points available in the instrument.

Response: 'DIAG\_IQOP3\_LCM\_CAL\_I,DIAG\_IQOP3\_LCM\_I,...

*RST value	Resolution	Options	SCPI
-	-	DIAGnostic2 only with option B20x	Device-specific

**DIAGnostic<[1]|2>[:MEASure]:POINt?**

The command triggers voltage measurement at the specified test point and returns the measured voltage. A detailed description of the test points can be found in chapter 3, section "Trouble Shooting" of the Service Manual (on CD-ROM, supplied with the instrument).

A list of the available test points for the respective path can be queried using the DIAG<[1]|2>:POIN:CAT? command.

**Example:** "DIAG:POIN? 'DIAG\_IQOP3\_LCM\_CAL\_I'"  
 'triggers measurement at the test point DIAG\_IQOP3\_LCM\_CAL\_I of Path A.

Response: 0.5  
 'the voltage at the test point is 0.5 volt.

*RST value	Resolution	Options	SCPI
-	-	DIAGnostic2 only with option B20x	Device-specific

# FORMat Subsystem

The FORMat subsystem contains the commands which determine the format of the data that the R&S Vector Signal Generator returns to the controller. This affects all query commands which return a list of numerical data or block data. Reference is made to this in the descriptions of the commands.

The data format is set simultaneously for both paths.

Command	Parameters	Default unit	Remark
FORMat:BORDER	NORMal   SWAPped		
FORMat[:DATA]	ASCii   PACKed		
FORMat:SREGister	ASCii   BINary   HEXadecimal   OCTal		

## FORMat:BORDER NORMal | SWAPped

The command determines the sequence of bytes within a binary block. This only affects blocks which use the IEEE754 format internally.

**Parameters:**     **NORMal**

'the R&S Vector Signal Generator expects (with setting commands) and sends (with queries) the least significant byte of each IEEE754 floating-point number first, and the most significant byte last.

**SWAPped**

'the R&S Vector Signal Generator expects (with setting commands) and sends (with queries) the most significant byte of each IEEE754 floating-point number first, and the least significant byte last.

**Example:**

"FORM:BORD SWAP"

'the data is transferred with the most significant bit first.

*RST value	Resolution	Options	SCPI
NORMal	-		Compliant

## FORMat[:DATA] ASCii | PACKed

The command determines the data format which the R&S Vector Signal Generator uses to return data. When data is transferred from the control computer to the instrument, the instrument detects the data format automatically. In this case, the value set here is irrelevant.

**Parameters:**     **ASCii**

'Numerical data is transferred as plain text separated by commas.

**PACKed**

'Numerical data is transferred as binary block data. The format within the binary data depends on the command. The various binary data formats are explained in the description of the parameter types.

**Example:**

"FORM ASC"

'the data is transferred as ASCII data.

*RST value	Resolution	Options	SCPI
ASCii	-		Compliant

**FORMat:SREGister** ASCii | BINary | HEXadecimal | OCTal

The command determines the numerical format which is returned when the status registers are queried.

**Parameters:**

**ASCii**

'the register content is returned as a decimal number.

**BINary**

'the register content is returned as a binary number. #B is placed in front of the number.

**HEXadecimal**

'the register content is returned as a hexadecimal number. #H is placed in front of the number.

**OCTal**

'the register content is returned as an octal number. #Q is placed in front of the number.

**Example:**

"FORM:SREG HEX"

'the register content is returned as a hexadecimal number.

*RST value	Resolution	Options	SCPI
ASCii	-		Compliant

## MMEMory Subsystem

The MMEMory subsystem (Mass Memory) contains the commands for managing files and directories as well as for loading and storing complete instrument settings in files.

The various drives can be selected using the "mass storage unit specifier " <msus>. The internal hard disk is selected with "D:\", and a memory stick which is inserted at the USB interface is selected with "E:\". The resources of a network can also be selected with <msus> in the syntax of the respective network, e.g. using the UNC format (Universal Naming Convention): '\\server\share'.

The default drive is determined using the command `MMEMory:MSIS <msus>`.

---

**Note:**

*The C: drive is a protected system drive. This drive should not be accessed. Reconstruction of the system partition will not be possible without loss of data.*

---

To enable files in different file systems to be used, the following file naming conventions should be observed:

The file name can be of any length and no distinction is made between uppercase and lowercase letters. The file and the optional file extension are separated by a dot. All letters and numbers are permitted (numbers are, however, not permitted at the beginning of the file name). Where possible, special characters should not be used. Use of the slashes "\" and "/" should be avoided since they are used in file paths. A number of names are reserved by the operating system, e.g. CLOCK\$, CON, AUX, COM1...COM4, LPT1...LPT3, NUL and PRN.

In the R&S Vector Signal Generator all files in which lists and settings are stored are given a characteristic extension. The extension is separated from the actual file name by a dot (see the following table containing a list of the file types).

The two characters "\*" and "?" function as "wildcards", i.e. they are used for selecting several files. The "?" character represents exactly one character, while the "\*" character represents all characters up to the end of the file name. "\*" therefore stands for all the files in a directory.

When used in conjunction with the commands, the parameter <file\_name> is specified as a string parameter with quotation marks. It can contain either the complete path including the drive, only the path and file name, or only the file name. The same applies for the parameters <directory\_name> and <path>. Depending on how much information is provided, either the values specified in the parameter or the values specified with the commands `MMEM:MSIS` (default drive) and `MMEM:CDIR` (default directory) are used for the path and drive setting in the commands.

In the example below, the current instrument setting is always stored in the file 'test1.ss' in the directory 'user' on the internal hard disk.

```
MMEM:STOR:STAT 0, "d:\user\test1.ss"
```

If the complete path including the drive letter is specified, the file is stored in the specified path.



```
MMEM:MSIS 'D:'
MMEM:STOR:STAT 0, "\user\test1.ss"
```

If the parameter only contains the path and file name, the default drive set with the MMEM:MSIS command is effective.

```
MMEM:MSIS 'd:\'
MMEM:CDIR 'user'
MMEM:STOR:STAT 0, "test1.ss"
```

If the parameter only contains the file name, the file is stored on the default drive MMEM:MSIS and in the default directory which was selected with the MMEM:CDIR command.

The data for **both** paths is always transferred simultaneously for all data transfer commands.

Table 6-1 List of file extensions assigned automatically in R&S Vector Signal Generator

List type	Contents	File suffix
<b>Instrument State</b>		
Instrument State	Instrument settings	*.savrc1
<b>User Correction</b>		
User Correction	User-defined level correction values	*.uco
<b>List Mode</b>		
List	User-defined frequency/level value pairs	*.lsw
<b>Arbitrary Waveform Generator</b>		
Waveform, Multi Segment Waveform	ARB waveforms	*.wv
Multi Segment Configuration	Configuration info for multi segment waveforms	*.inf_mswv
<b>DM</b>		
Data List	Digital modulation data	*.dm_iqd
Control List	Data to control digital modulation	*.dm_iqc
<b>GSM/EDGE</b>		
Slot	User-defined slot data	*.gsm_slu
Frame	User-defined frame data	*.gsm_fu
<b>3GPP FDD</b>		
3GPP Settings	Complete setting of the 2GPP (FDD) menu	*.3g
Channel Coding DPCH	Channel coding enhanced DPCH channels (uplink)	*.3g_ccod_ul
Channel Coding DPDCH	Channel coding enhanced DPDCH channels (downlink)	*.3g_ccod_dl
<b>CDMA2000</b>		
CDMA2000 Settings	Complete setting of the CDMA2000 menu	*.cdma2k
<b>WLAN</b>		
WLAN Settings	Complete setting of the IEEE 802.11 WLAN menu	*.wlan
<b>WiMAX</b>		
WiMAX Settings	Complete setting of the IEEE 802.16 WiMAX menu	*.wimax
<b>GPS</b>		
GPS Settings	Complete setting of the GPS menu	*.gps
<b>TD-SCDMA</b>		
TD-SCDMA Settings	Complete setting of the TD-SCDMA menu	*.tdscdma

Command	Parameters	Default unit	Remark
MMEMory:CATalog?	<path>		Query only
MMEMory:CATalog:LENGth?			Query only
MMEMory:CDIRectory	<directory_name>		No query
MMEMory:COpy	<file_name>,<file_name>		No query
MMEMory:DATA	<file_name>[,<block>]		
MMEMory:DCATalog?			Query only
MMEMory:DCATalog:LENGth?			Query only
MMEMory:LOAD:STATe	0,<file_name>		No query
MMEMory:DELeTe	<file_name>		No query
MMEMory:MDIRectory	<directory_name>		No query
MMEMory:MOVE	<file_name>,<file_name>		No query
MMEMory:MSIS	<msus>		
MMEMory:RDIRectory	<directory_name>		
MMEMory:STORe:STATe	0,<file_name>		

**MMEMory:CATalog? <path>**

This command reads out the subdirectories and files in the specified directory. If no directory is specified, the default directory selected with the MMEM:CDIR command is read out on the default drive selected with the MMEM:MSIS command.

The response has the following format:

```
<used_bytes_in_this_directory>,<free_bytes_on_this_disk>,  
"<file_name>,<file_type>,<filesize_in_bytes>",  
"<file_name>,<file_type>,<filesize_in_bytes>", ...
```

The command is a query command and therefore has no \*RST value.

**Parameters:**     <file\_name>  
                    File or directory name

**<file\_type>**  
File type. There are the following file types: DIR (directory), ASCii (ASCII file), BINary (Binary file), and STATe (file with instrument settings).

**<filesize\_in\_bytes>**  
File size. The size "0" is returned for a directory.

**Example:**       "MMEM:CAT? '\\Server\DATA\\*.LOG'  
                    Reads back all files in \\Server\DATA with the extension ".LOG".  
  
                    "MMEM:CAT? 'd:\user' "  
                    'reads out all files at the highest directory level of the memory stick.

**Response:**  
  
""127145265,175325184,"test,DIR,0","temp,DIR,0","readme.txt,ASC,1324","state.savrcl,STAT,5327","waveform.wv,BIN,2342"  
  
'the directory D:\User contains the subdirectories 'test' and 'temp' as well as the files 'readme.txt', 'state.savrcl' and 'waveform.wv' which have different file types.

*RST value	Resolution	Options	SCPI
-	-		Compliant

**MMEMory:CATalog:LENGth?** <path>

This command reads out the number of files in the specified directory. If no directory is specified, the default directory selected with the `MMEM:CDIR` command is read out on the default drive selected with the `MMEM:MSIS` command.

The command is a query command and therefore has no \*RST value.

**Example:** `"MMEM:CAT:LENG? 'e:\"`  
 'reads out the number of files at the highest directory level of the memory stick.

Response: `"1"`  
 'there is 1 file at the highest directory level of the memory stick.

*RST value	Resolution	Options	SCPI
-	-		Device-specific

**MMEMory:CDIRectory** <directory\_name>

This command changes the default directory. This directory is used for all subsequent MMEM commands if no path is specified with them. It is also possible to change to a higher directory using two dots '..'.

**Example:** `"MMEM:CDIR 'test'"`  
 'changes from the current directory level to the subdirectory 'test'.

*RST value	Resolution	Options	SCPI
D:\	-		Compliant

**MMEMory:COPY** <source>[,<destination>]

This command copies the first specified file to the second specified file. Instead of just a file, this command can also be used to copy a complete directory together with all its files.

If <destination> is not specified, <source> is copied to the `MMEM:MSIS` drive and the `MMEM:CDIR` directory. Files which already exist with the same name in the destination directory are overwritten without an error message.

It is also possible to specify the path using another parameter. The command is:

**MMEMory:COPY** <file\_source><msus\_source>[,<file\_destination>,<msus\_destination>]

The command triggers an event and therefore has no query form and no \*RST value.

**Example:** `"MMEM:COPY 'D:\USER\TEST1.SVARCL','E:'"`  
 'copies the file 'test1.savrcl' in the USER directory on the internal hard disk to the memory stick without changing the file name.

*RST value	Resolution	Options	SCPI
-	-		Compliant

**MMEMory:DATA** <file\_name>[,<binary block data>]  
**MMEMory:DATA?** <file\_name>

This command writes the block data <binary block data> to the file identified by <file\_name>. The IEC/IEEE-bus terminator should be set to EOI in order to ensure correct data transfer.

The associated query command transfers the specified file from the R&S Vector Signal Generator to the IEC/IEEE bus and then on to the control computer. It is important to ensure that the intermediate memory on the control computer is large enough to take the file. In this case, the setting for the IEC/IEEE-bus terminator is irrelevant. This command can be used to read/transfer stored instrument settings or waveforms directly from/to the instrument.

The binary data block has the following structure: #234<block\_data>

# always comes first in the binary block

<number> indicates how many digits the subsequent length entry has (2 in example)

<number> indicates the number of subsequent bytes (34 in example)

<binary block data> binary block data for the specified length

**Example:** "MMEM:DATA 'TEST1.WV',#3767<binary data>"  
 'writes the block data to the file 'test1.wv'.

"MMEM:DATA? 'TEST1.WV'"  
 'sends the data of the file 'Test1.wv' from the R&S Vector Signal Generator to the control computer in the form of a binary block.

*RST value	Resolution	Options	SCPI
-	-		Compliant

**MMEMory:DCATalog?** <path>

This command reads out the subdirectories of the specified directory. If no directory is specified, the default directory selected with the `MMEM:CDIR` command is read out. The directories are output in a list (the list entries are separated by commas).

The command is a query command and therefore has no \*RST value.

**Example:** "MMEM:DCAT?"  
 'reads out the subdirectories of the current directory.

Response: "'test', 'wave', 'digital'"  
 'the subdirectories 'test', 'wave' and 'digital' exist in the current directory.

*RST value	Resolution	Options	SCPI
-	-		Device-specific

**MMEMemory:DCATalog:LENGth? <path>**

This command reads out the number of subdirectories in the specified directory. If no directory is specified, the directory selected with the MMEM:CDIR command is read out.

**Example:** "MMEM:DCAT:LENG  
 'reads out the number of subdirectories in the current directory.  
 Response: "3"  
 'there are 3 subdirectories in the current directory.

*RST value	Resolution	Options	SCPI
-	-		Device-specific

**MMEMemory:DELeTe <file\_name>**

This command deletes the specified file.

The command triggers an event and therefore has no query form and no \*RST value.

**Example:** "MMEM:DEL 'D:\USER\TEST1.SAVRCL'"  
 'deletes the file 'Test1.savrcl' in the USER directory on the internal hard disk.

*RST value	Resolution	Options	SCPI
-	-		Compliant

**MMEMemory:LOAD:STATe 0,<file\_name>**

This command loads the specified file stored under the specified name in an internal memory. If 0 is used, the instrument setting of the selected file is set directly in the R&S Vector Signal Generator. The \*RCL command is used to load the immediate instrument setting (see the section "[Common Commands](#)").

If a number other than 0 is used when storing, the instrument setting must be activated using an \*RCL command with this number after the file has been loaded.

**Example:** "MMEM:LOAD:STAT 0,'D:\user\test1.savrcl'"  
 'loads the file 'Test1.savrcl' in the USER directory of the internal hard disk and activates the associated instrument setting.  
 "MMEM:STOR:STAT 4,'D:\user\test4.savrcl'"  
 'stores the file 'Test4.savrcl' in the USER directory of the internal hard disk.  
 "MMEM:LOAD:STAT 4,'D:\user\test4.savrcl'"  
 'loads the file 'Test4.savrcl' in the USER directory of the internal hard disk.  
 "\*RCL 4"  
 'activates the instrument setting of the file 'Test4.savrcl'.

*RST value	Resolution	Options	SCPI
-	-		Compliant

**MMEMory:MDIRectory** <directory\_name>

The command creates a new subdirectory in the specified directory. If no directory is specified, a subdirectory is created in the default directory. This command can also be used to create a directory tree.

The command triggers an event and therefore has no query form and no \*RST value.

**Example:** "MMEM:MDIR 'carrier'"  
 'creates the subdirectory 'carrier' in the current directory.

*RST value	Resolution	Options	SCPI
-	-		Device-specific

**MMEMory:MOVE** <file\_source>,<file\_destination>

This command renames an existing file if no path is specified for <file\_destination>. Otherwise the file is moved to the specified path and stored under the original file name or, if specified, a new file name. It is also possible to specify the path using another parameter. The command is:

**MMEMory:MOVE** <file\_source><msus\_source>[,<file\_destination>,<msus\_destination>]

The command triggers an event and therefore has no query form and no \*RST value.

**Example:** "MMEM:MOVE 'test1.savrcl', 'keep1.savrcl'"  
 'renames the file 'test1.savrcls' as 'keep1.savrcl'.  
 "MMEM:MOVE 'test1.savrcl', '\smate\_one\keep1.savrcl'"  
 'moves the file 'test1.savrcl' to the subdirectory 'smate\_one' and stores it there under the name 'keep1.savrcl'.

*RST value	Resolution	Options	SCPI
-	-		Compliant

**MMEMory:MSIS** <msus>

The command sets the drive (or network resource in the case of networks) using <msus> (MSIS = **M**ass **S**torage **I**dentification **S**tring). This setting is effective for all MMEMory commands where the drive is not explicitly specified in the parameter.

**Example:** "MMEM:MSIS 'E: '"  
 'selects the memory stick as the default drive.

*RST value	Resolution	Options	SCPI
D:\	-		Compliant

**MMEMory:RDIRectory** <directory\_name>

The command deletes the specified subdirectory in the specified directory. If no directory is specified, the subdirectory with the specified name is deleted in the default directory.

The command triggers an event and therefore has no query form and no \*RST value.

**Example:** "MMEM:RDIR 'carrier'"  
'deletes the subdirectory 'carrier' in the current directory.

*RST value	Resolution	Options	SCPI
-	-		Device-specific

**MMEMory:STORE:STATe** 0,<file\_name>

This command stores the current instrument setting in the specified file. If 0 is specified, the current instrument setting is stored directly in the specified file. The intermediate instrument settings can be stored using the \*SAV command (see the section "[Common Commands](#)", page 6.4).

If a number other than 0 is specified, the instrument setting must first be stored in an internal memory with the same number using the common command \*SAV.

The command triggers an event and therefore has no query form and no \*RST value.

**Example:** "MMEM:STOR:STAT 0, 'D:\USER\TEST1.ss'"  
'stores the current instrument setting in the file 'test1.ss' in the USER directory on the internal hard disk.

*RST value	Resolution	Options	SCPI
-	-		Compliant

# OUTPut Subsystem

The OUTPut system contains the commands which set the properties of the RF output connectors and USER connectors. The properties of the LF output connector are set in the SOURce:LFOutput system.

In the case of two-path instruments with a second RF path (option R&S SMATE-B20x), the properties can be set separately and independently for the two RF outputs A and B. The suffix under SOURce distinguishes the outputs:

OUTPut[1] = RF output A

OUTPut2 = RF output B

Commands `OUTPut:BLANK:POLarity` and `OUTPut:USER<1...4>:SOURce` affect the setting of the USER connectors and are without suffix in the OUTPut keyword.

Command	Parameters	Default unit	Remark
OUTPut:ALL[:STATe]	ON   OFF		
OUTPut<[1] 2>:AFIXed:RANGe:LOWer?		dBm	Query only
OUTPut<[1] 2>:AFIXed:RANGe:UPPer?		dBm	Query only
OUTPut<[1] 2>:AMODe	AUTO   FIXed   NORMal		
OUTPut:BLANK:POLarity	NORMal   INVerted		
OUTPut<[1] 2>:IMPedance		Ohm	Query only
OUTPut<[1] 2>[:STATe]	ON   OFF		
OUTPut<[1] 2>[:STATe]:PON OUTPut:USER<1...4>:SOURce	OFF   UNCHanged AMARk4   BMARK4   ABLank   BBLank   AHOP   BHOP   ACW   BCW   BBITclock   BBURst   ATRig   BTRig   BSYMBOLclock   BATTenuator		

## OUTPut:ALL[:STATe] ON | OFF

The command switches on or off all RF output signals of the instrument.

The numerical suffix under OUTPut is irrelevant.

**Example:**           "OUTP:ALL OFF"  
                          'switches off all RF output signals.

*RST Value	Resolution	Options	SCPI
OFF	-	-	Device-specific



**OUTPut<[1]|2>:AFIXed:RANGe:LOWer?**

The command queries the minimum level which can be set without the attenuator being adjusted (Attenuator FIXed).

The command is a query and therefore has no \*RST value.

**Example:**           "OUTP:AFIX:RANG:LOW?"  
                          'queries the minimum level for the FIXed setting'.

Response:"-50"  
                          'the minimum level is -50 dBm.'

*RST value	Resolution	Options	SCPI
-	-	OUTPut2 only with option B20x	Device-specific

**OUTPut<[1]|2>:AFIXed:RANGe:UPPer?**

The command queries the maximum level which can be set without the attenuator being adjusted (Attenuator FIXed).

The command is a query and therefore has no \*RST value.

**Example:**           ":OUTP2:AFIX:RANG:UPP?"  
                          'queries the maximum level for the FIXed setting for RF output B'.

Response:"-27"  
                          'the maximum level is -27 dBm.'

*RST value	Resolution	Options	SCPI
-	-	OUTPut2 only with option B20x	Device-specific

**OUTPut<[1]|2>:AMODe** AUTO | FIXed | NORMal | HPOWer

The command switches the mode of the attenuator at the RF output (Attenuator MODE).

**Parameters:**     **AUTO**

The electronically switching attenuator switches with a 5 dB step width at fixed switching points.

**With option High Power:** The level settings are made in the area of the electronically switching attenuator as well as the relay-switched option. The entire level range is available.

**FIXed**

The attenuator is fixed at the current position. The uninterrupted level settings are made if automatic level control is activated (SOURce:POWer:ALC ON).

**With option High Power:** The level settings are made without switching the high-power output option. When this operating mode is switched on, the option are fixed in their current positions and the resulting variation range is defined.

**NORMal**

**With Option High Power only:** The level settings are made only in the area of the electronically switching attenuator. The high level ranges are not available.

**HPOWer**

**With Option High Power only:** The level settings are made only in the area of the option. Only the high level range is available. The relays are not switched.

**Example:**

```
" :POW:ALC ON"
'activates automatic level control for RF output A.

"OUTP:AMOD FIX"
'sets the fixed mode with uninterrupted level for RF output A.
```

*RST value	Resolution	Options	SCPI
AUTO	-	OUTPut2 only with option B20x Selection NORMal and HPOWer only with one of the options B31 or B36	Device-specific

**OUTPut<[1]|2>:BLANK:POLarity** NORMal | INVerted

The command sets the polarity of the No Signal (Blank) Marker.

**Example:**

```
"OUTP:BLAN:POL NORM"
'causes the No Signal state (settling process in List mode) to be displayed as a result of the high output voltage (HIGH).
```

*RST value	Resolution	Options	SCPI
NORMal	-	OUTPut2 only with option B20x	Device-specific

**OUTPut<[1]|2>:IMPedance**

The command queries the impedance of the RF outputs. This permits converting the output level between units V and W. The impedances cannot be changed.

The command is a query and therefore has no \*RST value.

**Example:**       ":OUTP2:IMP?"  
                  'queries the impedance of RF output B.

Response: "50"  
           'the impedance is 50 ohms

*RST value	Resolution	Options	SCPI
-	-	OUTPut2 only with option B20x	Compliant

**OUTPut<[1]|2>[:STATe] ON | OFF**

This command activates and deactivates the RF output.

**Example:**       ":OUTP OFF"  
                  'deactivates the RF output A.

*RST value	Resolution	Options	SCPI
-	-	OUTPut2 only with option B20x	Compliant

**OUTPut<[1]|2>[:STATe]:PON OFF | UNCHanged**

This command selects the state which the RF output assumes when the instrument is switched on.

The command is an event and therefore has no \*RST value and no query form.

**Parameters:**   **OFF**  
                  The output is deactivated when the instrument is switched on.

**UNCHanged**  
When the instrument is switched on, the output remains in the same state as it was when the instrument was switched off.

**Example:**       "OUTP:PON OFF"  
                  'RF output A is deactivated when the instrument is switched on.

*RST value	Resolution	Options	SCPI
-	-	OUTPut2 only with option B20x	Device-specific

**OUTPut<[1]|2>:USER<1...4>:SOURce**

AMARk4 | BMArk4 | ABLank | BBLank | AHOP | BHOP | ACW | BCW | BBITclock | BSYMBOLclock | BATTenuator | BBURst | ATRig | BTRig

The command selects the signal for the specified USER interface.

The numerical suffix under OUTPut is irrelevant for this command since the USER interfaces are not assigned to any particular path. Some signals which can be applied at the USER interface are permanently assigned (e.g. LEV-ATT control signal of Path B), and some are assigned using a dedicated command (e.g. OUTP:CW:SOURce for the CW control signal).

**Example:**

"OUTP:USER2 BSYM"

'causes the internally generated clock signal of Path B to be output at the USER2 pin of the AUX I/O interface.

"OUTP:CLOC:MODE SYMB"

'specifies that the internally generated clock pulse is a symbol clock pulse.

"OUTP:CLOC:STAT ON"

'activates output of the symbol clock pulse at the USER2 pin.

*RST value	Resolution	Options	SCPI
USER1 = AMARker4 USER2 = ACW USER3 = ABLank USER4 = ATRig	-	OUTPut2 only with option B20x	Device-specific

# SENSe and READ Subsystem

The SENSe subsystem contains the commands for configuring the power measurements with power sensors connected to the generator. The measurement is started and the measurement result retrieved with the READ command. The description of this command is included in the following.

Up to three sensors can be connected to the signal generator. They are distinguished by means of the suffix under SENSe:

Power sensor connected to the SENSOR port = SENSe[1]

First Power sensor connected to the USB interface = SENSe 2

Second Power sensor connected to the USB interface = SENSe 3

Command	Parameters	Default unit	Remark
READ<[1]...3>[:POWer]			Query only
SENSe<[1]...3>[:POWer]:FILTer:LENGth	1 ...65536		
SENSe<[1]...3>[:POWer]:FILTer:SONCe			No query
SENSe<[1]...3>[:POWer]:FILTer:TYPE	AUTO   USER		
SENSe<[1]...3>[:POWer]:FREQUency	<frequency>	Hz	Range depends on used sensor
SENSe<[1]...3>[:POWer]:SNUMber			Query only
SENSe<[1]...3>[:POWer]:SOURce	A   B   USER		
SENSe<[1]...3>[:POWer]:STATus[:DEVice]			Query only
SENSe<[1]...3>[:POWer]:TYPE			Query only
SENSe<[1]...3>[:POWer]:ZERO			No Query
SENSe<[1]...3>:UNIT[:POWer]	DBM   DBUV   WATT	DBM	No query

## READ<[1]...3>[POWer]?

The command retrieves the power measurement result of the selected power sensor. The value is provided with the unit set with command `SENSe:UNIT[:POWer]`.

The command is a query command and therefore has no \*RST value.

**Example:** `SENS:UNIT DBM`  
 'selects unit dBm for presentation of measurement result.

`READ?`  
 'queries the measurement result.

Response: `-45.6`  
 '-45.6 dBm were measured at the given frequency.

*RST value	Resolution	Options	SCPI
-	-		Device specific

**SENSe<[1]...3>[:POWER]:FILTer:LENGth 1 ... 65536**

The command selects the filter length for user filter mode (:SENSe:POWer:FILTer:TYPE USER). As the filter length works as a multiplier for the time window, a constant filter length results in a constant measurement time. Values 1 and  $2^n$  are settable. In remote control, when using command READ to retrieve the measurement result, the time window is fixed to 20 ms.

**Example:**       SENS:FILT:TYPE USER  
                  'selects user filter mode-

                  SENS:FILT:LENG 16  
                  'sets a filter length of 16. The resulting measurement time is 640 ms  
                  (2x16x20 ms).

*RST value	Resolution	Options	SCPI
1	-		Device specific

**SENSe<[1]...3>[:POWER]:FILTer:SONC**

The command activates the search for the optimum filter length for the current measurement conditions. The found filter length can be retrieved with command :SENSe:POWer:FILTer:LENGth?.

The command is a query command and therefore has no \*RST value.

**Example:**       SENS:FILT:SONC  
                  'activates the search for the optimum filter length.

                  SENS:FILT:LENG?  
                  'returns the found optimum filter length.

                  Response: 128

*RST value	Resolution	Options	SCPI
-	-		Device specific

**SENSe<[1]...3>[:POWER]:FILTer:TYPE AUTO | USER**

The command selects the filter mode. The filter length is the multiplier for the time window and thus directly influences the measurement time.

**Parameters:**   **AUTO**  
                  The filter length is automatically selected depending on the measured value. For high values, a short filter length is selected and for low values a long filter length is selected.

**USER**  
                  The filter length is set manually. As the filter length works as a multiplier for the measurement time, this results in a constant measurement time.

**Example:**       SENS:FILT:TYPE AUTO  
                  'selects automatic filter selection.

*RST value	Resolution	Options	SCPI
AUTO	-		Device specific

**SENSe<[1]...3>[:POWer]:FREQuency <frequency>**

The command sets the RF frequency of the source if the user source is selected  
(SENSe[:POWer]:SOURce USER.

**Example:**           SENS:SOUR USER  
                          'selects user-defined source.  
  
                          SENS:FREQ 2.44 GHz"  
                          'enters the RF frequency of the source which is 2.44 GHz.

*RST value	Resolution	Options	SCPI
1 GHz	-		Device specific

**SENSe<[1]...3>[:POWer]:SNUMber?**

The command queries the serial number of the sensor.  
The command is a query command and therefore has no \*RST value.

**Example:**           "SENS:SNUM?"  
                          'queries the serial number.

*RST value	Resolution	Options	SCPI
-	-		Device specific

**SENSe<[1]...3>[:POWer]:SOURce A | B | USER**

The command selects the signal source for the measurement. The RF signal of path A or path B or a user defined source can be selected.

**Example:**           SENS:SOUR A  
                          'selects the RF signal of path A. The frequency is set to the frequency for this signal path.

*RST value	Resolution	Options	SCPI
A	-		Device specific

**SENSe<[1]...3>[:POWER]:STATus[:DEVIce]?**

The command queries if a sensor is connected at the selected port to the signal generator. The sensor is selected by suffix **1**, **2** or **3** in key word SENSE or READ of the command header. Suffix 1 denotes the sensor connected to the SENSOR connector, suffix 2 the sensor connected first to one of the USB interfaces and suffix 3 the sensor connected second to one of the USB interfaces.

The command is a query command and therefore has no \*RST value.

**Example:**           SENS : STAT?  
                          'queries if a sensor is connected to the POWER SENSOR interface.

Response: 1  
                          'a sensor is connected to the POWER SENSOR interface.

*RST value	Resolution	Options	SCPI
-	-		Device specific

**SENSe<[1]...3>[:POWER]:TYPE?**

The command queries the type of sensor connected at the selected port. The type is automatically detected.

The command is a query command and therefore has no \*RST value.

**Example:**           "SENS : TYPE?"  
                          'queries the type of sensor connected to the POWER SENSOR connector.

Response: NRP-Z21  
                          'the R&S NRP-Z21 sensor is used.

*RST value	Resolution	Options	SCPI
-	-		Device specific

**SENSe<[1]...3>[:POWER]:ZERO**

The command activates the autozero function. Zeroing is required in regular interval (at least once a day) and if the temperature has varied more than about 5 °C, if the sensor has been replaced or if measurements of signals with very low power are to be performed. The sensor must be disconnected from all power sources before starting the autozero function.

The command is an event and therefore has no \*RST value.

**Example:**           SENS : ZERO  
                          'activates autozero function.

*RST value	Resolution	Options	SCPI
-	-		Device specific



**SENSe<[1]...3>:UNIT[:POWer] DBM | DBUV | WATT**

The command selects the unit used for result query with command READ. The power sensor provides the measured value in Watt. In which unit the measured value is returned is selected here and might be either Watt, dBm or dBuV.

The command is a query command and therefore has no \*RST value.

**Example:**           "SENS:UNIT DBM"  
                      'selects unit dBm for the measured value returned by command READ.

Response: 7.34  
          '7.34 dBm are measured by sensor 2.

*RST value	Resolution	Options	SCPI
-	-		Device specific

## SOURce Subsystem

The SOURce subsystem contains the commands for configuring the digital and analog signals. In the case of two-path channels, the suffix 2 identifies the signals of Path B under SOURce:

Path A = SOURce[1]

Path B = SOURce 2

LF output = SOURce:LFOutput

The keyword SOURce is optional with commands for Path A and the LF output and can be omitted. For Path B, the command must contain the keyword together with the suffix 2.

---

### Note:

*With the R&S SMIQ generator family, the LF signal source is selected using the numerical suffix 2 under SOURce. With the R&S SMATE generator family, however, SOURce2 selects RF output B. The two instrument families are therefore incompatible with respect to actuation of the LF generator.*

---

## SOURce:AM Subsystem

The AM subsystem contains the commands for checking the amplitude modulation and also the broadband amplitude modulation. The settings for the internal modulation source (LF generator) are made in the SOURce:LFOutput subsystem.

In the case of two-path instruments with a second RF path (option R&S SMATE-B20x), the amplitude modulation can be set separately and independently for the two RF outputs. The suffix under SOURce distinguishes the outputs:

SOURce[1] = RF output A

SOURce2 = RF output B

The keyword SOURce is optional with commands for RF output A and can be omitted. For RF output B, the command must contain the keyword together with the suffix 2.

Command	Parameters	Default unit	Remark
[SOURce:]AM:BBANd:SENSitivity?			Query only
[SOURce:]AM:BBANd:STATe]	ON   OFF		
[SOURce<[1] 2>:]AM[:DEPT]h]	0...100 PCT	PCT	
[SOURce<[1] 2>:]AM:EXTernal:COUPLing	AC   DC		
[SOURce<[1] 2>:]AM:SENSitivity?			Query only
[SOURce<[1] 2>:]AM:SOURce	EXT   INT   INT, EXT		
[SOURce<[1] 2>:]AM:STATe	ON   OFF		

**[SOURce:]AM:BBANd:SENSitivity?**

The command queries the input sensitivity in V/100% modulation depth.

The command is a query command and therefore has no \*RST value. Broadband amplitude modulation is only possible for Path A.

**Example:** "AM:BBAN:SENS?"  
'queries the input sensitivity for the BB-AM modulation signal at the I input.

Response: "0.25"  
'the input sensitivity is 0.25 V / 100 % depth.

*RST value	Resolution	Options	SCPI
-	-	-	Compliant

**[SOURce:]AM:BBANd[:STATe] ON | OFF**

The command activates/deactivates the broadband amplitude modulation. It is not possible to set a modulation depth for BB-AM. The modulation input is the I IN connector. Broadband amplitude modulation is only possible for Path A.

Activation of broadband amplitude modulation deactivates AM, ARB, I/Q modulation, digital modulation and all digital standards.

**Example:** "AM:BBAN ON"  
'activates BB-AM modulation.

*RST value	Resolution	Options	Correlation	SCPI
OFF	-		AM:BBAN ON deactivates BB-AM, ARB, I/Q modulation, DM and all digital standards.	Compliant

**[SOURce<[1]|2>:]AM[:DEPTh] 0 ... 100 PCT**

The command sets the modulation depth of the amplitude modulation in percent. The modulation depth is limited by the maximum peak envelope power (PEP).

**Example:** "AM 15PCT"  
'sets the AM modulation depth to 15 percent.

*RST value	Resolution	Options	SCPI
30 PCT	See data sheet	SOURce2 only with option B20x	Compliant

**[SOURce<[1]|2>:]AM:EXTernal:COUPling AC | DC**

The command selects the coupling mode for the external modulation input (EXT MOD) in the case of amplitude modulation.

**Parameters:**     **AC**  
                           The DC voltage component is disconnected from the modulation signal.

**DC**  
                           The modulation signal is not changed.

**Example:**         "AM:EXT:COUP AC"  
                           'selects the coupling mode AC for external amplitude modulation in Path A.

*RST value	Resolution	Options	SCPI
AC	-	SOURce2 only with option B20x	Compliant

**[SOURce<[1]|2>:]AM:SENSitivity?**

The command queries the input sensitivity of the EXT MOD input in %/V. The command is only effective if the external modulation source is selected (SOUR:AM:SOUR EXT). The returned value depends on the modulation depth setting (SOUR:AM:DEPT<sub>h</sub>). This value is assigned to the voltage value for full modulation of the input.

The command is a query command and therefore has no \*RST value.

**Example:**         "AM:DEPT 50"  
                           'sets a modulation depth of 50 %.

                      "AM:SENS?"  
                           'queries the input sensitivity at the EXT MOD input.

**Response:** "50"  
                           'since the voltage value for full modulation is 1V, the resulting sensitivity is precisely 50%/V.

*RST value	Resolution	Options	SCPI
-	-	SOURce2 only with option B20x	Compliant

**[SOURce<[1]|2>:]AM:SOURce EXT | INT | INT,EXT**

The command selects the modulation source for amplitude modulation. INT is the LF generator. The frequency of the internal modulation signal can be set in the SOURce:LFOuTput subsystem. The external signal is input at the EXT MOD connector. Internal and external modulation source can be selected at the same time.

**Example:**         "AM:SOUR INT"  
                           'selects the internal modulation source.

*RST value	Resolution	Options	SCPI
INTernal	-	SOURce2 only with option B20x	Compliant

[SOURce<[1]|2>:]AM:STATe ON | OFF

The command activates/deactivates amplitude modulation.

Activation of amplitude modulation deactivates BB-AM, ARB, I/Q modulation, digital modulation and all digital standards.

**Example:** "AM:STAT ON"  
'activates AM modulation.

*RST value	Resolution	Options	Correlation	SCPI
OFF	-	SOURce2 only with option B20x	AM ON deactivates BB-AM, ARB, I/Q modulation, DM and all digital standards.	Compliant

# SOURce:AWGN Subsystem

The Source:AWGN subsystem contains the commands for setting the noise generator.

In the case of two-path instruments, the numerical suffix under SOURce distinguishes between noise generation in Path A and Path B.

[SOURce<1>] = Path A

:SOURce2 = Path B

The keyword SOURce is optional with commands for Path A and can be omitted. For Path B, the command must contain the keyword together with the suffix 2.

The keyword SOURce is optional and can be omitted.

Command	Parameters	Default unit	Remark
[SOURce<[1] 2>:]AWGN:BRATe	400... 250E6 bps		
[SOURce<[1] 2>:]AWGN:BWIDth	1kHz .. 80 MHz	Hz	
[SOURce<[1] 2>:]AWGN:BWIDth:NOISe?			Query only
[SOURce<[1] 2>:]AWGN:BWIDth:RATio	1 ... 80 000		
[SOURce<[1] 2>:]AWGN:CNRatio	-30dB..+30dB	dB	
[SOURce<[1] 2>:]AWGN:ENRatio	<numeric_value>	dB	
[SOURce<[1] 2>:]AWGN:FREQuency:RESult			Query only
[SOURce<[1] 2>:]AWGN:FREQuency:TARGet	0 ... 50 MHz	Hz	
[SOURce<[1] 2>:]AWGN:MODE	ADD   ONLY   CW		
[SOURce<[1] 2>:]AWGN:POWer:CARRier	<numeric_value>	dBm	
[SOURce<[1] 2>:]AWGN:POWer:MODE	CN   EN		
[SOURce<[1] 2>:]AWGN:POWer:NOISe	<numeric_value>	dBm	
[SOURce<[1] 2>:]AWGN:POWer:NOISe:TOTal			Query only
[SOURce<[1] 2>:]AWGN:POWer:RMODE	CARRier   NOISe		
[SOURce<[1] 2>:]AWGN:POWer:SUM?		dBm	Query only
[SOURce<[1] 2>:]AWGN:POWer:SUM:PEP?		dBm	Query only
[SOURce<[1] 2>:]AWGN:STATe	ON   OFF		

## [SOURce<[1]|2>:]AWGN:BRATe 400... 250E6 bps

This command sets the bit rate which is used for calculation of bit energy to noise power ratio from carrier/noise ratio for **Digital Standard** signals. For **Custom Digital Mod** signals, the bit rate which is used for calculation can be queried with this command. Valid units are bps, kbps and mabps as well as b/s, kb/s and mab/s.

**Example:** "AWGN:BRAT?"  
'queries the bit rate which is used for calculation of the  $E_b/N_0$  value from the C/N value.

*RST value	Resolution	Options	SCPI
100 kbps	0.001 bps	B13 and K62 SOURce2 only with option B20x and second B13 option	Device-specific

**[SOURce<[1]|2>:]AWGN:BWIDth 1 kHz ... 80 MHz**

This command sets the system bandwidth. The noise signal at the level which corresponds to the specified carrier/noise ratio is generated in the bandwidth specified here.

This command is available for modes **Additive Noise** and **Noise Only** (SOUR:AWGN:MODE ADD|ONLY).

**Example:** "AWGN:BWID 10 MHz"  
'sets a system bandwidth of 10 MHz.

*RST value	Resolution	Options	SCPI
3.84 MHz	0.1 kHz	B13 and K62 SOURce2 only with option B20x and second B13 option	Device-specific

**[SOURce<[1]|2>:]AWGN:BWIDth:NOISe?**

This command queries the real noise bandwidth.

This command is available for modes **Additive Noise** and **Noise Only** (SOUR:AWGN:MODE ADD|ONLY). The command is a query command and therefore has no \*RST value.

**Example:** "AWGN:BWID:NOIS?"  
'queries the noise bandwidth.

*RST value	Resolution	Options	SCPI
		B13 and K62 SOURce2 only with option B20x and second B13 option	Device-specific

**[SOURce<[1]|2>:]AWGN:BWIDth:RATio 1.0 ... 80 000.0**

This command sets the ratio of minimum real noise bandwidth to system bandwidth. The overall bandwidth "System BW x Minimum Noise/System BW Ratio" may not exceed 80 MHz. Therefore, the available value range depends on the selected system bandwidth.

This command is available for modes **Additive Noise** and **Noise Only** (SOUR:AWGN:MODE ADD|ONLY).

**Example:** "AWGN:BWID:RAT 2"  
'sets a minimum noise/system bandwidth ratio of 2.

*RST value	Resolution	Options	SCPI
1	0.1	B13 and K62 SOURce2 only with option B20x and second B13 option	Device-specific

[SOURce<[1]]2>:AWGN:CNRatio -40 dB ... +30 dB

This command sets the carrier/interferer ratio. The value range depends on the selected AWGN mode (AWGN:MODE ADD|ONLY|CW).

With **Reference Mode Carrier** (AWGN:POW:RMODE CARRIER) the noise level is adjusted to the set C/N ratio and the carrier level is kept constant.

With **Reference Mode Carrier** (AWGN:POW:RMODE NOISE) the carrier level is adjusted to the set C/N ratio and the noise level is kept constant.

This command is available for modes **Additive Noise** and **CW Interferer** (SOUR:AWGN:MODE ADD|CW).

**Example:** "AWGN:CNR 10"  
'sets a carrier/noise ratio of 10 dB.

*RST value	Resolution	Options	SCPI
0 dB	0.001 dB	B13 and K62 SOURce2 only with option B20x and second B13 option	Device-specific

[SOURce<[1]]2>:AWGN:ENRatio -30 dB ... +30 dB

This command sets the ratio of bit energy to noise power density in **Additive Noise** mode. Depending on the selected reference mode either the noise level (:AWGN:POW:RMODE NOISE) or the carrier level (AWGN:POW:RMODE CARRIER) is adjusted to the set  $E_b/N_0$  ratio.

With **Reference Mode Carrier** (AWGN:POW:RMODE CARRIER) the noise level is adjusted to the set  $E_b/N_0$  ratio and the carrier level is kept constant.

With **Reference Mode Carrier** (AWGN:POW:RMODE NOISE) the carrier level is adjusted to the set  $E_b/N_0$  ratio and the noise level is kept constant.

For **Digital Standard** signals, the bit rate used for calculation of  $E_b/N_0$  value from C/N value can be entered with command SOUR:AWGN:BRAT.

For **Custom Digital Mod** signals the bit rate used for calculation of  $E_b/N_0$  value from C/N value is determined by the selected standard (SOURce:BB:DM:STANDARD) and cannot be changed.

**Example:** "AWGN:ENR 10"  
'sets a ratio of bit energy to noise power density of 10 dB.

*RST value	Resolution	Options	SCPI
0 dB	0.001 dB	B13 and K62 SOURce2 only with option B20x and second B13 option	Device-specific



**[SOURce<[1]]2>:AWGN:FREQUency:RESulting**

This command queries the actual frequency of the sine in the **CW Interferer** mode. The actual frequency may differ from the desired frequency, since the resolution is limited to 0.7 Hz.

The command is a query command and therefore has no \*RST value.

**Example:** "AWGN:FREQ:RES?"  
'queries the actual frequency of the interfering sine.

*RST value	Resolution	Options	SCPI
		B13 and K62 SOURce2 only with option B20x and second B13 option	Device-specific

**[SOURce<[1]]2>:AWGN:FREQUency:TARGet 0 Hz ... +50 MHz**

This command sets the desired frequency of the sine in **CW Interferer** mode (AWGN:MODE CW). The resulting frequency may differ from the desired frequency because of the limited frequency resolution of 0.7 Hz.

**Example:** "AWGN:FREQ:TARG 2kHz"  
'sets a frequency of 2 kHz for the interfering sine.

*RST value	Resolution	Options	SCPI
0 Hz	0.07 Hz	B13 and K62 SOURce2 only with option B20x and second B13 option	Device-specific

**[SOURce<[1]]2>:AWGN:MODE ADD | ONLY | CW**

This command selects the mode for generating the interfering signal.

**Parameters:** **ADD**  
The AWGN noise signal is added to the baseband signal.

**ONLY**  
The pure AWGN noise signal is modulated to the carrier. The connection to the baseband is interrupted.

**CW**  
The sine interfering signal is added to the baseband signal.

**Example:** "AWGN:MODE ONLY"  
'activates the generation of a pure noise for path A.  
"AWGN:STAT ON"  
'switches on the generation of a pure noise for path A.

*RST value	Resolution	Options	SCPI
ADD	-	B13 and K62 SOURce2 only with option B20x and second B13 option	Device-specific

**[SOURce<[1]]2>:AWGN:POWer:CARRier -145 dBm...30 dBm**

This command either sets or queries the carrier level depending on the selected reference mode.

With **Reference Mode Carrier** (SOUR:AWGN:POW:RMOD CARR), the command sets the carrier level. The level of the noise signal is derived from the entered C/N value.

With **Reference Mode Noise** (SOUR:AWGN:POW:RMOD NOIS), the command queries the carrier level which is derived from the entered C/N value. The noise level is set with command SOUR:AWGN:POW:NOISe.

This command is available for modes **Additive Noise** and **CW Interferer** (SOUR:AWGN:MODE ADD|CW).

**Example:** "SOUR:AWGN:POW:CARR 10 dBm"  
'sets a carrier level of 10 dB.

*RST value	Resolution	Options	SCPI
- 30 dBm	0.01 dBm	B13 and K62 SOURce2 only with option B20x and second B13 option	Device-specific

**[SOURce<[1]]2>:AWGN:POWer:MODE CN | EN**

This command selects the mode for setting the noise level.

This command is available for mode **Additive Noise** (SOUR:AWGN:MODE ADD).

**Parameters:** **CN**  
The noise level is set on the basis of the value entered for the carrier/noise ratio (SOUR:AWGN:CNR).

**EN**  
The noise level is set on the basis of the value entered for the ratio of bit energy to noise power density (SOUR:AWGN:ENR).

**Example:** "SOUR:AWGN:POW:MODE CN"  
'the noise level is set on the basis of the value entered for the carrier/noise ratio (SOUR:AWGN:CNR).

*RST value	Resolution	Options	SCPI
CN		B13 and K62 SOURce2 only with option B20x and second B13 option	Device-specific

**[SOURce<[1]|2>:]AWGN:POWer:NOISe -145 dBm...30 dBm**

This command sets or queries the noise level in the system bandwidth depending on the selected modes:

**Additive Noise and CW Interferer mode** (SOUR:AWGN:MODE ADD|CW):

With **Reference Mode Carrier** (SOUR:AWGN:POW:RMOD CARR), the command queries the noise level which is derived from the entered C/N value. The carrier level is set with command SOUR:AWGN:POW:CARRier.

With **Reference Mode Noise** (SOUR:AWGN:POW:RMOD NOIS), the command sets the noise level. The level of the carrier signal is derived from the entered C/N value.

**Noise Only mode**

The command sets the noise level.

**Example:** "SOUR:AWGN:POW:NOIS?"  
'queries the noise level in the system bandwidth.

Response: "10"  
'the noise level in the system bandwidth is 10 dBm.

*RST value	Resolution	Options	SCPI
- 30 dBm	0.01 dBm	B13 and K62 SOURce2 only with option B20x and second B13 option	Device-specific

**[SOURce<[1]|2>:]AWGN:POWer:NOISe:TOTal?**

This command queries the noise level in the total bandwidth.

The command is a query command and therefore has no \*RST value.

**Example:** "SOUR:AWGN:POW:NOIS:TOT?"  
'queries the noise level in the total bandwidth.

Response: "15"  
'the noise level in the total bandwidth is 15 dBm.

*RST value	Resolution	Options	SCPI
-	-	B13 and K62 SOURce2 only with option B20x and second B13 option	Device-specific

[SOURce<[1]|2>:]AWGN:POWER:RMODE CARRier | NOISe

This command selects the mode for setting the interfering signal.

This command is available for modes **Additive Noise** and **CW Interferer** (SOUR:AWGN:MODE ADD|CW).

**Parameters:**      **CARRier**

The carrier level is kept constant when the C/N value or Eb/N<sub>0</sub> value is changed. The noise level is adjusted.

**NOISe**

The noise level is kept constant when the C/N value or Eb/N<sub>0</sub> value is changed. The carrier level is adjusted.

**Example:**

"AWGN:MODE ADD"

'selects **Additive Noise** mode.

"AWGN:POW:RMODE NOIS"

'selects **Reference Mode Noise**. The noise level is kept constant when the C/N value or Eb/N<sub>0</sub> value is changed. The carrier level is adjusted.

*RST value	Resolution	Options	SCPI
CARRier		B13 and K62 SOURce2 only with option B20x and second B13 option	Device-specific

[SOURce<[1]|2>:]AWGN:POWER:SUM?

This command queries the overall level of the noise signal plus useful signal.

This command is available for modes **Additive Noise** and **CW Interferer** (SOUR:AWGN:MODE ADD|CW). The command is a query command and therefore has no \*RST value.

**Example:**

"SOUR:AWGN:POW:SUM?"

'queries the overall level of the noise signal plus useful signal.

*RST value	Resolution	Options	SCPI
		B13 and K62 SOURce2 only with option B20x and second B13 option	Device-specific

[SOURce<[1]|2>:]AWGN:POWER:SUM:PEP?

This command queries the peak envelope power of the overall signal comprised of noise signal plus useful signal.

This command is available for modes **Additive Noise** and **CW Interferer** (SOUR:AWGN:MODE ADD|CW). The command is a query command and therefore has no \*RST value.

**Example:**

"SOUR:AWGN:POW:SUM:PEP?"

'queries the peak envelope power of the overall signal.

*RST value	Resolution	Options	SCPI
		B13 and K62 SOURce2 only with option B20x and second B13 option	Device-specific

[SOURce<[1]|2>:]AWGN:STATe ON | OFF

This command activates or deactivates the white noise (AWGN = Averaged White Gaussian Noise). The noise signal is either superimposed on the baseband signal (**Additive Noise** mode (SOUR:AWGN:MODE ADD)) or is output as a pure noise signal (**Noise Only** mode (SOUR:AWGN:MODE ONLY)). In addition, a sine with adjustable frequency offset to the baseband signal can be generated as an RFI signal (**CW Interferer** mode; SOUR:AWGN:MODE CW).

**Example:** "AWGN:STAT ON"  
'activates the RFI signal generator of path A.

*RST value	Resolution	Options	SCPI
OFF	-	B13 and K62 SOURce2 only with option B20x and second B13 option	Device-specific

# SOURce:BB Subsystem

This subsystem contains all commands for digital signal generation. It is divided into several subsystems which are described separately, e.g., SOURce.BB:DM for Custom Digital Modulation, SOURce:BB:GSM for GSM/EDGE modulation, etc..

The following section describes the commands for setting the frequency shift and the phase offset for the signal at the **Baseband** block output and the signal routing for two-path instruments.

The numeric suffix to SOURce distinguishes between the signal for path A and path B in the case of two-path instruments:

SOURce<1> = path A

SOURce2 = path B

The keyword SOURce is optional in the case of commands for path A and can be omitted. For path B the command must contain the keyword with suffix 2.

In this section, all commands for setting or querying the characteristics of two-path instruments are described.

Command	Parameter	Default unit	Note
[SOURce<[1] 2>:]BB:FOFFset	<numeric_value>	Hz	
[SOURce:]BB:PATH:COUNt			
[SOURce<[1] 2>:]BB:PGAin	<numeric_value>	dB	
[SOURce<[1] 2>:]BB:POFFset	<numeric_value>	RAD	
[SOURce<[1] 2>:]BB:ROUte	A   B   AB		

## [SOURce<[1]|2>:]BB:FOFFset <numeric\_value>

The command sets the frequency offset for the baseband signal. The offset affects the signal on the **baseband block** output. It shifts the useful baseband signal in the center frequency.

**Note:**

*It is not possible to enter a frequency offset if a waveform with a sample rate of exactly 100 MHz is introduced. A signal of this nature is not routed via the resampler in which the frequency shift takes place. This type of entry is also prohibited if the noise generator (AWGN block) is on.*

The complex I/Q bandwidth of the useful signal must not exceed 80 MHz in total. The following applies:

$$f_{offset} - \frac{f_{use}}{2} \geq -40MHz \quad \text{and} \quad f_{offset} + \frac{f_{use}}{2} \leq +40MHz$$

$f_{use}$  = the complex useful bandwidth of the I/Q signal before the offset.

$f_{offset}$  = frequency offset.

**Example:** "BB:FOFF 2MHZ"  
'sets a frequency offset of 2 MHz.

*RST value	Resolution	Options	SCPI
0 Hz	0.01 Hz	B10/B11 and B13 Second option B13	Device-specific

**[SOURce:]BB:PATH:COUNT?**

The command queries the number of installed baseband paths.

This command is a query and therefore has no \*RST value.

**Example:** "BB:PATH:CONT?"  
'queries the number of baseband paths.

Response: "1"  
'the instrument is equipped with one baseband path.

*RST value	Resolution	Options	SCPI
	-	B10/B11 and B13 Response 2 only with second option B10/B11	Device-specific

**[SOURce<[1]|2>:]BB:PGAin <numeric\_value>**

The command sets the relative path gain for the selected baseband signal compared to the baseband signals of the other baseband sources (second path or external baseband). The gain affects the signal on the **baseband block** output.

**Example:** "BB:PGA 3dB"  
'sets a relative path gain of 3 dB for the baseband signal of path A compared to the baseband signal of path B.

*RST value	Resolution	Options	SCPI
0 dB	0.1 dB	B10/B11 and B13 Second option B13	Device-specific

**[SOURce<[1]|2>:]BB:POFFset <numeric\_value>**

The command sets the relative phase offset for the selected baseband signal compared to the baseband signals of the other baseband sources (second path or external baseband). The gain affects the signal on the **baseband block** output.

**Example:** "BB:POFF 0.5DEG"  
'sets a relative phase offset of 0.5 DEG for the baseband signal of path A compared to the baseband signal of path B.

*RST value	Resolution	Options	SCPI
0 DEG	0.1 DEG	B10/B11 and B13 Second option B13 B10/B11 and B13	Device-specific

**[SOURce<[1]|2>:]BB:ROUTe A | B | AB**

The command selects the signal route for the baseband signal of a two-path instrument.

- Parameter:**
- A**  
The baseband signal is introduced into path A. The signals from both paths are summed if necessary.
  - B**  
The baseband signal is introduced into path B. The signals from both paths are summed if necessary.
  - AB**  
The baseband signal is introduced into path A and path B. The signals from both paths are summed if necessary.

**Example:** "SOUR2:BB:ROUT A"  
'the baseband signal of path B is introduced into path A.

*RST value	Resolution	Options	SCPI
A	-	B10/B11 and B13 SOURce2 only with second option B9/B10/B11	Device-specific



## SOURce:BB:ARB Subsystem

The ARB subsystem contains the commands for setting the ARB Generator.

Settings for clock and trigger interfaces and for external outputs are entered in the SOURce:INPut and SOURce:OUTPut subsystems.

The numeric suffix to SOURce distinguishes between signal output for path A and path B in the case of two-path instruments:

SOURce[1] = path A

SOURce2 = path B

Section "[R&S Vector Signal Generator Waveform and List Format](#)", page 6.88 describes the ARB waveform format and how it is used to transmit waveforms via the IEC bus.

Command	Parameter	Default unit	Note
[SOURce<[1] 2>:]BB:ARB:CLOCK	400 Hz ... 100 MHz	-	
[SOURce<[1] 2>:]BB:ARB:CLOCK:MODE	SAMPlE   MSAMPlE		
[SOURce<[1] 2>:]BB:ARB:CLOCK:MULTIplier	1... 64		
[SOURce<[1] 2>:]BB:ARB:CLOCK:SOURce	INTernal   EXTernal		
[SOURce<[1] 2>:]BB:ARB:MCARrier:CARRier:COUNT	1 ... 32	-	
[SOURce<[1] 2>:]BB:ARB:MCARrier:CARRier<0...31>:DELay	-1s ... +1s	s	
[SOURce<[1] 2>:]BB:ARB:MCARrier:CARRier<0...31>:FILE	'file name'		
[SOURce<[1] 2>:]BB:ARB:MCARrier:CARRier<0...31>:PHASe	0° ... 360°	RAD	
[SOURce<[1] 2>:]BB:ARB:MCARrier:CARRier<0...31>:POWer	-80... 0 dB	dB	
[SOURce<[1] 2>:]BB:ARB:MCARrier:CARRier:SPACing	0 Hz...50 MHz	Hz	
[SOURce<[1] 2>:]BB:ARB:MCARrier:CARRier<0...31>:STATe	ON   OFF		
[SOURce<[1] 2>:]BB:ARB:MCARrier:CFACTOR:MODE	OFF   MAX   MIN		
[SOURce<[1] 2>:]BB:ARB:MCARrier:CLOAD			No query
[SOURce<[1] 2>:]BB:ARB:MCARrier:CLOCK			Query only
[SOURce<[1] 2>:]BB:ARB:MCARrier:CREate			No query
[SOURce<[1] 2>:]BB:ARB:MCARrier:EDIT:CARRier:DELay[:START]	-1s ... +1s	s	
[SOURce<[1] 2>:]BB:ARB:MCARrier:EDIT:CARRier:DELay:STEP	-1s ... +1s	s	
[SOURce<[1] 2>:]BB:ARB:MCARrier:EDIT:CARRier:EXECute			No query
[SOURce<[1] 2>:]BB:ARB:MCARrier:EDIT:CARRier:FILE	'file name'		
[SOURce<[1] 2>:]BB:ARB:MCARrier:EDIT:CARRier:PHASe[:START]	0...360DEG	RAD	
[SOURce<[1] 2>:]BB:ARB:MCARrier:EDIT:CARRier:PHASe:STEP	-360...360DEG	RAD	
[SOURce<[1] 2>:]BB:ARB:MCARrier:EDIT:CARRier:POWer[:START]	-80 ... 0 dB	dB	
[SOURce<[1] 2>:]BB:ARB:MCARrier:EDIT:CARRier:POWer:STEP	-80 ... 80 dB	dB	
[SOURce<[1] 2>:]BB:ARB:MCARrier:EDIT:CARRier:STARt	<carrier_index>		
[SOURce<[1] 2>:]BB:ARB:MCARrier:EDIT:CARRier:STATe	ON   OFF		
[SOURce<[1] 2>:]BB:ARB:MCARrier:EDIT:CARRier:STOP	<carrier_index>		
[SOURce<[1] 2>:]BB:ARB:MCARrier:OFILe	<file_name>		
[SOURce<[1] 2>:]BB:ARB:MCARrier:PRESet	-		
[SOURce<[1] 2>:]BB:ARB:MCARrier:SAMPles		sample	Query only

Command	Parameter	Default unit	Note
[SOURce<[1]2>:]BB:ARB:MCARrier:SETTing:CATalog			Query only
[SOURce<[1]2>:]BB:ARB:MCARrier:SETTing:LOAD	<file_name>		
[SOURce<[1]2>:]BB:ARB:MCARrier:SETTing:STORe	<file_name>		
[SOURce<[1]2>:]BB:ARB:MCARrier:TIME		s	
[SOURce<[1]2>:]BB:ARB:MCARrier:TIME:MODE	LONG   SHORT   OFF		
[SOURce<[1]2>:]BB:ARB:PRESet			No query
[SOURce<[1]2>:]BB:ARB:SEQuence	AUTO / RETRigger / AAUTO / ARETrigger		
[SOURce<[1]2>:]BB:ARB:STATe	ON   OFF		
[SOURce<[1]2>:]BB:ARB:TRIGger:ARM:EXECute			No query
[SOURce<[1]2>:]BB:ARB:TRIGger:EXECute			No query
[SOURce<[1]2>:]BB:ARB:TRIGger[:EXTErnal<[1]2>]:DELay	0 ... 2 <sup>32</sup> -1 Samples	-	
[SOURce<[1]2>:]BB:ARB:TRIGger[:EXTErnal<[1]2>]:INHibit	0 ... 2 <sup>32</sup> -1 Samples	-	
[SOURce<[1]2>:]BB:ARB:TRIGger:OBASeband:DELay	0 ... 2 <sup>32</sup> -1 Samples	-	
[SOURce<[1]2>:]BB:ARB:TRIGger:OBASeband:INHibit	0 ... 2 <sup>32</sup> -1 Samples	-	
[SOURce<[1]2>:]BB:ARB:TRIGger:OUTPut<[1]...4>:DELay	0 ... 2 <sup>20</sup> -1 Samples		
[SOURce<[1]2>:]BB:ARB:TRIGger:OUTPut:DELay:FIXed	ON   OFF		
[SOURce<[1]2>:]BB:ARB:TRIGger:OUTPut<[1]...4>:DELay:MAX			Query only
[SOURce<[1]2>:]BB:ARB:TRIGger:OUTPut<[1]...4>:DELay:MIN?			Query only
[SOURce<[1]2>:]BB:ARB:TRIGger:OUTPut<[1]...4>:EXECute			No query
[SOURce<[1]2>:]BB:ARB:TRIGger:OUTPut<[1]...4>:MODE	UNCHanged   RESTart   PULSe   PATTern   RATio		
[SOURce<[1]2>:]BB:ARB:TRIGger:OUTPut<[1]...4>:OFFTime	1 ... max_wavelength -1 samples		
[SOURce<[1]2>:]BB:ARB:TRIGger:OUTPut<[1]...4>:ONTime	1 ... max_wavelength -1 samples		
[SOURce<[1]2>:]BB:ARB:TRIGger:OUTPut<[1]...4>:PATTern	#B0,1 ... #B111...1,32		
[SOURce<[1]2>:]BB:ARB:TRIGger:OUTPut<[1]...4>:PULSe:DIVider	2...2 <sup>10</sup>		
[SOURce<[1]2>:]BB:ARB:TRIGger:OUTPut<[1]...4>:PULSe:FREQ			Query only
[SOURce<[1]2>:]BB:ARB:TRIGger:RMODE			Query only
[SOURce<[1]2>:]BB:ARB:TRIGger:SLENgth	1 ... 2 <sup>32</sup> -1 Samples		
[SOURce<[1]2>:]BB:ARB:TRIGger:SLUNit	SAMPle   SEQuence		
[SOURce<[1]2>:]BB:ARB:TRIGger:SMODE	SAME   NEXT   NSEAm		Query only
[SOURce<[1]2>:]BB:ARB:TRIGger:SOURce	INTernAl   EXTErnAl   BEXTErnAl   OBASeband		
[SOURce<[1]2>:]BB:ARB:TSIGnal:SINE:FREQuency	100 Hz ... 25 MHz	HZ	
[SOURce<[1]2>:]BB:ARB:TSIGnal:SINE:PHASe	-180.00 Deg ... + 180.00 Deg	RAD	
[SOURce<[1]2>:]BB:ARB:TSIGnal:SINE:SAMPle	3 ... 1000 samples per period		
[SOURce<[1]2>:]BB:ARB:WAVEform:CATalog?			Query only
[SOURce<[1]2>:]BB:ARB:WAVEform:CATalog:LENGth?			Query only
[SOURce<[1]2>:]BB:ARB:WAVEform:DATA	<file_name>[, <block> ]		
[SOURce<[1]2>:]BB:ARB:WAVEform:DATA?	<file_name>, <tag>		
[SOURce<[1]2>:]BB:ARB:WAVEform:DELeTe	<name_of_waveform_file>		No query

Command	Parameter	Default unit	Note
[SOURce<[1]>:]BB:ARB:WAVeform:FREE			Query only
[SOURce<[1]>:]BB:ARB:WAVeform:POINts			Query only
[SOURce<[1]>:]BB:ARB:WAVeform:SELEct	<name_of_waveform_file>		
[SOURce<[1]>:]BB:ARB:WAVeform:TAG?	'comment'   'copyright'   'date'   'laccfilter'   'marker name'   'poweroffset'		
[SOURce<[1]>:]BB:ARB:WSEGment			Query only
[SOURce<[1]>:]BB:ARB:WSEGment:CLOAd			No query
[SOURce<[1]>:]BB:ARB:WSEGment:CONFIgure:CATalog			Query only
[SOURce<[1]>:]BB:ARB:WSEGment:CONFIgure:CLOCK	max Sample Rate ... 100 MHz		
[SOURce<[1]>:]BB:ARB:WSEGment:CONFIgure:CLOCK:MODE	UNCHanged   HIGHest   USER		
[SOURce<[1]>:]BB:ARB:WSEGment:CONFIgure:COMMeNT	<string>		
[SOURce<[1]>:]BB:ARB:WSEGment:CONFIgure:DELEte			No query
[SOURce<[1]>:]BB:ARB:WSEGment:CONFIgure:LEVEl[:MODE]	UNCHanged   ERMS		
[SOURce<[1]>:]BB:ARB:WSEGment:CONFIgure:OFILe	<file_name>		
[SOURce<[1]>:]BB:ARB:WSEGment:CONFIgure:SEGMeNT:APPend	<file_name>		
[SOURce<[1]>:]BB:ARB:WSEGment:CONFIgure:SEGMeNT:CATalog			Query only
[SOURce<[1]>:]BB:ARB:WSEGment:CONFIgure:SELEct	<file_name>		
[SOURce<[1]>:]BB:ARB:WSEGment:CREate			No query
[SOURce<[1]>:]BB:ARB:WSEGment:NEXT	1 ... 1999		

### [SOURce<[1]>:]BB:ARB:CLOCK <numeric\_value>

The command sets the clock rate in samples. Loading a waveform sets the clock rate that is defined in the waveform tag 'clock'. The command subsequently changes the clock rate; see data sheet for value range.

In the case of an external clock source (selection `ARB:CLOCK:SOURce EXTErnal`) the clock for the external source must be entered with this command.

**Example:**            "`BB:ARB:CLOC:SOUR INT`"  
                          'selects the internal clock source for generating waveforms.

                          "`BB:ARB:CLOC 0.5 MHz`"  
                          'sets the clock rate to 0.5 MHz.

*RST value	Resolution	Options	Dependency	SCPI
1 MHz	0.001 Hz	B10/B11 and B13 SOURce2 only with second option B9/B10/B11	Loading a waveform ( <code>ARB:WAV:SEL &lt;name&gt;</code> ) automatically sets the clock rate to the allocated value.	Device-specific

[SOURce<[1]]2>:]BB:ARB:CLOCK:MODE SAMPlE | MSAMPlE

The command enters the type of externally supplied clock (:BB:ARB:CLOCK:SOURce EXTERNAL) .. When MSAMPlE is used, a multiple of the sample clock is supplied via the CLOCK connector and the sample clock is derived internally from this. The multiplier is entered with the command :BB:ARB:CLOCK:MULTIPLIER.

With this command the only numerical suffix allowed for SOURce is 1, since the external clock source is permanently allocated to path A.

**Example:** "BB:ARB:CLOC:MODE SAMP"  
'selects clock type **Sample**, i.e. the supplied clock is a sample clock.

*RST value	Resolution	Options	SCPI
SAMPlE	-	B10/B11 and B13 SOURce2 only with second option B9/B10/B11	Device-specific

[SOURce<[1]]2>:]BB:ARB:CLOCK:MULTIPLIER 1 ... 64

The command specifies the multiplier for clock type **Multiple Samples** (:BB:ARB:CLOCK:MODE MSAM) in the case of an external clock source.

With this command the only numerical suffix allowed for SOURce is 1, since the external clock source is permanently allocated to path A.

**Example:** "BB:ARB:CLOC:SOUR EXT"  
'selects the external clock source. The clock is supplied via the CLOCK connector.

"BB:ARB:CLOC:MODE MSAM"  
'selects clock type **Multiple Samples**, i.e. the supplied clock has a rate which is a multiple of the sample rate.

"BB:ARB:CLOC:MULT 12"  
'the multiplier for the external clock rate is 12.

*RST value	Resolution	Options	SCPI
4	1	B10/B11 and B13 SOURce2 only with second option B9/B10/B11	Device-specific

[SOURce<[1]|2>:]BB:ARB:CLOCK:SOURce INTernal | EXTernal

The command selects the source for the digital modulation clock.

**Parameter:**       **INTernal**  
                           The internal clock reference is used.

**EXTernal**  
                           The external clock reference is supplied to the CLOCK connector.

**Example:**       "BB:ARB:CLOC:SOUR EXT"  
                           'selects an external clock reference for path A. The clock is supplied via the  
                           CLOCK connector.  
                           "BB:ARB:CLOC:MODE SAMP"  
                           'enters clock type sample.

*RST value	Resolution	Options	SCPI
INTernal		B10/B11 and B13 SOURce2 only with second option B9/B10/B11	Device-specific

[SOURce<[1]|2>:]BB:ARB:MCARrier:CARRier:COUNT 1 ... 32

The command sets the number of carriers in the ARB multi-carrier waveform. The total bandwidth (*Number of carriers - 1*) \* *Carrier spacing* is 80 MHz. The number of carriers entered therefore defines the maximum carrier spacing (:BB:ARB:MCARrier:CARRier:SPACing).

**Example:**       "BB:ARB:MCAR:CARR:COUN 10"  
                           'sets 10 carriers for the multi-carrier waveform.

*RST value	Resolution	Options	Dependencies	SCPI
1	1	B10/B11 and B13 SOURce2 only with second option B9/B10/B11	The carrier spacing (:BB:ARB:MCAR:CARR:SPAC) is reduced if the total bandwidth of 80 MHz is not respected when entering the number of carriers.	Device-specific

[SOURce<[1]|2>:]BB:ARB:MCARrier:CARRier<0...31>:DELay -1s ... +1s.

The command sets the start delay of the selected carrier.

**Example:**       "BB:ARB:MCAR:CARR15:DEL 5us"  
                           'sets a start delay of 50 us for carrier 15.

*RST value	Resolution	Options	SCPI
0 s	1 ns	B10/B11 and B13 SOURce2 only with second option B9/B10/B11	Device-specific

**[SOURce<[1]|2>:]BB:ARB:MCARrier:CARRier<0...31>:FILE "file name"**

The command selects the file with I/Q data to be modulated onto the selected carrier.

**Example:** "BB:ARB:MCAR:CARR15:FILE 'C:\IQ\_wcdma'"  
 'selects file 'IQ\_wcdma' The data of the file is modulated onto carrier 15

*RST value	Resolution	Options	SCPI
-	-	B10/B11 and B13 SOURce2 only with second option B9/B10/B11	Device-specific

**[SOURce<[1]|2>:]BB:ARB:MCARrier:CARRier<0...31>:PHASe 0 ... 360 DEG.**

The command sets the start phase of the selected carrier.

The phase settings are only valid if optimization of the crest factor is disabled  
 (:SOURce:BB:ARB:MCARrier:CFACTOR:MODE OFF).

**Example:** "BB:ARB:MCAR:CARR15:PHAS 90 DEG"  
 'sets a start phase of 90° for carrier 15.

*RST value	Resolution	Options	SCPI
0 DEG	0.01 DEG	B10/B11 and B13 SOURce2 only with second option B9/B10/B11	Device-specific

**[SOURce<[1]|2>:]BB:ARB:MCARrier:CARRier<0...31>:POWER 80 dB ... 0 dB**

The command sets the gain of the selected carrier.

**Example:** "BB:ARB:MCAR:CARR15:POW -50 dB"  
 'sets the power of carrier 15 to -50 dB.

*RST value	Resolution	Options	SCPI
0 dB	0.01 dB	B10/B11 and B13 SOURce2 only with second option B9/B10/B11	Device-specific

[SOURce<[1]|2>:]BB:ARB:MCARrier:CARRier:SPACing 0 Hz ... 50 MHz

The command sets the frequency spacing between adjacent carriers of the multi-carrier waveform. The carriers are generated symmetrically around the RF carrier. The maximum carrier spacing is limited to  $Carrier\ spacing = Total\ baseband\ bandwidth / (Number\ of\ carriers - 1)$ . The total baseband bandwidth is 80 MHz.

**Note:**

*In order to avoid wrap-around problems, the effective **Carrier Spacing** might be slightly modified. The **Carrier Spacing** is rounded in that way that the carrier closest to the center RF frequency shows no phase jump assuming that the carrier is unmodulated.*

*For odd number of carriers:*

*RoundedCarrierSpacing=1/OutputSignalDuration\* round(CarrierSpacing \* OutputSignalDuration);*

*For even number of carriers:*

*RoundedCarrierSpacing=2/OutputSignalDuration\*round(0.5 \*CarrierSpacing \* OutputSignalDuration);*

**Example:** "BB:ARB:MCAR:CARR:SPAC 10 MHz"  
'sets a carrier spacing of 10 MHz.

*RST value	Resolution	Options	Dependencies	SCPI
10 kHz	0.01 Hz	B10/B11 and B13 SOURce2 only with second option B9/B10/B11	The maximum carrier spacing is automatically reduced so that the maximum total bandwidth of 80 MHz is not exceeded on entering the number of carriers (:BB:ARB:MCAR:CARR:COUN).	Device-specific

[SOURce<[1]|2>:]BB:ARB:MCARrier:CARRier<0...31>:STATe ON | OFF

The command switches the selected carrier on or off.

**Example:** "BB:ARB:MCAR:CARR15:STAT ON"  
'switches carrier 15 on.

*RST value	Resolution	Options	SCPI
ON	-	B10/B11 and B13 SOURce2 only with second option B9/B10/B11	Device-specific

[SOURce<[1]]2>:]BB:ARB:MCARrier:CFACtor:MODE OFF | MIN | MAX

The command sets the mode for optimizing the crest factor by calculating the carrier phases.

**Parameter:**     **OFF**  
 There is no automatic setting for minimizing or maximizing the crest factor. The **Phase** setting (command BB:ARB:MCAR:CARR:PHAS) is in use.

**MIN**  
 The crest factor is minimized by internally calculating optimized carrier phases. The Phase setting (command BB:ARB:MCAR:CARR:PHAS) is invalid.

**MAX**  
 The crest factor is maximized by internally calculating optimized carrier phases. The Phase setting (command BB:ARB:MCAR:CARR:PHAS) is invalid.

**Example:**       "BB:ARB:MCAR:CFAC:MODE OFF"  
 'switches off automatic crest factor optimization. The setting SOUR:BB:ARB:MCAR:CARR:PHAS has an effect.

*RST value	Resolution	Options	SCPI
OFF	-	B10/B11 and B13 SOURce2 only with second option B9/B10/B11	Device-specific

[SOURce<[1]]2>:]BB:ARB:MCARrier:CLOad <file\_name>

This command creates a multi-carrier waveform using the current entries of the carrier table.

This multi-carrier waveform is saved with the file name specified with command SOUR:BB:ARB:MCAR:OFIL. The file extension is \*. **wv**. Digital standard **ARB** is activated, the new multi-carrier waveform is loaded and is output in accordance to the trigger settings.

This command triggers an event and therefore has no \*RST value and no query form.

**Example:**       "MMEM:CDIR 'D:\user\waveform"  
 'sets the default directory to D:\user\waveform.  
 "BB:ARB:MCAR:OFIL 'mcar1\_2'"  
 'defines the file name mcar1\_2.wv for the multi-carrier waveform.  
 "BB:ARB:MCAR:CLO"  
 'creates multi-carrier waveform mcar1\_2.wv.  
 The new multi-carrier waveform is loaded and digital standard **ARB** is activated.

*RST value	Options	Dependencies	SCPI
-	B10/B11 and B13 SOURce2 only with second option B9/B10/B11	SOUR:BB:ARB:WAV:SEL = <new Waveform> SOUR:BB:ARB:STATe = ON	device-specific



**[SOURce<[1]2>:]BB:ARB:MCARrier:CLOCK**

The command queries the resulting sample rate at which the multi-carrier waveform is output by the arbitrary waveform generator. The output clock rate depends on the number of carriers, carrier spacing and input sample rate of the leftmost or rightmost carriers.

The command is a query command and therefore has no \*RST value.

**Example:**           "BB:ARB:MCAR:CLOC?"  
                      'queries the ARB multi-carrier output clock rate.

*RST value	Resolution	Options	SCPI
-	-	B10/B11 and B13 SOURce2 only with second option B9/B10/B11	Device-specific

**[SOURce<[1]2>:]BB:ARB:MCARrier:CREate**

This command creates a multi-carrier waveform using the current settings of the carrier table. The multi-carrier waveform is saved into the file defined with command SOUR:BB:ARB:MCAR:OFIL. The file extension is \*.wv.

This command triggers an event and therefore has no \*RST value and no query form.

**Example:**           "MMEM:CDIR 'D:\user\waveform'"  
                      'sets the default directory to D:\user\waveform.  
  
                      "BB:ARB:MCAR:OFIL 'multi\_wv1'"  
                      'defines the file name multi\_wv1.wv for the multi-carrier waveform.  
  
                      "BB:ARB:MCAR:CRE"  
                      'creates multi-carrier waveform multi\_wv1.wv.

*RST value	Resolution	Options	SCPI
-	-	B10/B11 and B13 SOURce2 only with second option B9/B10/B11	device-specific

**[SOURce<[1]2>:]BB:ARB:MCARrier:EDIT:CARRier:DELay[:START] -1s ... +1s**

The command sets the start delay for the individual carriers in the defined carrier range. If the command :BB:ARB:MCAR:EDIT:CARR:DEL:STEP is used to define a step width, the delay entered here applies only to the starting carrier. The delays of the remaining carriers are stepped up or down by the delay value specified in the :BB:ARB:MCAR:EDIT:CARR:DEL:STEP command.

**Example:**           "BB:ARB:MCAR:EDIT:CARR:DEL 5us"  
                      'sets a start delay of 5 us for the carriers in the carrier range.

*RST value	Resolution	Options	SCPI
0 s	1 ns	B10/B11 and B13 SOURce2 only with second option B9/B10/B11	Device-specific

**[SOURce<[1]]2>:]BB:ARB:MCARrier:EDIT:CARRier:DELay:STEP -1s ... +1s**

The command sets the step width by which the start delays of the carriers in the defined carrier range will be incremented.

**Example:** "BB:ARB:MCAR:EDIT:CARR:DEL 5 us"  
 'sets a start delay of 5 us for the carriers in the carrier range.  
 "BB:ARB:MCAR:EDIT:CARR:DEL:STEP 1 us"  
 'the start delay is incremented by 1us for each carrier, i.e. the first carrier has a start delay of 5us, the second a start delay of 6 us, etc.

*RST value	Resolution	Options	SCPI
0s	1 ns	B10/B11 and B13 K61 SOURce2 only with second option B9/B10/B11	Device-specific

**[SOURce<[1]]2>:]BB:ARB:MCARrier:EDIT:CARRier:EXECute**

The command adopts the settings for the carrier range which has been defined using the :BB:ARB:MCAR:EDIT:CARR:... commands.

**Example:** "BB:ARB:MCAR:EDIT:CARR:STAR 4"  
 'the carrier range starts at carrier 2.  
 "BB:ARB:MCAR:EDIT:CARR:STOP 20"  
 'the carrier range stops at carrier 20.  
 "BB:ARB:MCAR:EDIT:CARR:STAT ON"  
 'sets all the carriers in the carrier range (2 to 20) to ON.  
 "BB:ARB:MCAR:EDIT:CARR:EXEC"  
 'transfers the assistant settings for carrier 2 to 20 into the carrier table.

*RST value	Resolution	Options	SCPI
		B10/B11 and B13 SOURce2 only with second option B9/B10/B11	Device-specific

**[SOURce<[1]]2>:]BB:ARB:MCARrier:EDIT:CARRier:FILE "file name"**

The command selects the input file with I/Q data to be modulated onto the carriers in the defined carrier range.

**Example:** "BB:ARB:MCAR:EDIT:CARR:FILE 'C:\IQ\_wcdma'"  
 'selects input file 'IQ\_wcdma' The data of the file are modulated onto the carriers in the defined carrier range.

*RST value	Resolution	Options	SCPI
-	-	B10/B11 and B13 SOURce2 only with second option B9/B10/B11	Device-specific

**[SOURce<[1]>:]BB:ARB:MCARrier:EDIT:CARRier:PHASe[:START] 0 ... 360 DEG.**

The command sets the start phase for the individual carriers in the defined carrier range. If the command :BB:ARB:MCAR:EDIT:CARR:PHAS:STEP is used to define a step width, the phase entered here applies only to the starting carrier. The phases of the remaining carriers are stepped up or down by the phase value specified in the :BB:ARB:MCAR:EDIT:CARR:PHAS:STEP command.

The phase settings are only valid if optimization of the crest factor is disabled (:SOURce:BB:ARB:MCARrier:CFACTOR:MODE OFF).

**Example:** "BB:ARB:MCAR:EDIT:CARR:PHAS 90 DEG"  
'sets a start phase of 90° for the carriers in the carrier range.

*RST value	Resolution	Options	SCPI
0 DEG	0.01 DEG	B10/B11 and B13 SOURce2 only with second option B9/B10/B11	Device-specific

**[SOURce<[1]>:]BB:ARB:MCARrier:EDIT:CARRier:PHASe:STEP 0 ... 360 DEG.**

The command sets the step width by which the start phases of the carriers in the defined carrier range will be incremented.

The phase settings are only valid if optimization of the crest factor is disabled (:SOURce:BB:ARB:MCARrier:CFACTOR:MODE OFF).

**Example:** "BB:ARB:MCAR:EDIT:CARR:PHAS 90 DEG"  
'sets a start phase of 90° for the carriers in the carrier range.  
"BB:ARB:MCAR:EDIT:CARR:PHAS:STEP 1 DEG"  
'the start phase is incremented by 1° for each carrier, i.e. the first carrier has a start phase of 90°, the second a start phase of 91°, etc.

*RST value	Resolution	Options	SCPI
0 DEG	0.01 DEG	B10/B11 and B13 SOURce2 only with second option B9/B10/B11	Device-specific

**[SOURce<[1]>:]BB:ARB:MCARrier:EDIT:CARRier:POWER[:START] 80 dB ... 0 dB**

The command sets the power for the individual carriers in the defined carrier range. If the command :BB:ARB:MCAR:EDIT:CARR:POW:STEP is used to define a step width, the power entered here applies only to the starting carrier. The power of the remaining carriers is stepped up or down by the power specified in the :BB:ARB:MCAR:EDIT:CARR:POW:STEP command.

**Example:** "BB:ARB:MCAR:EDIT:CARR:POW -50 dB"  
'sets the power of the carriers in the carrier range to -50 dB.

*RST value	Resolution	Options	SCPI
0 dB	0.01 dB	B10/B11 and B13 SOURce2 only with second option B9/B10/B11	Device-specific

**[SOURce<[1]|2>:]BB:ARB:MCARrier:EDIT:CARRier:POWer:STEP - 80 dB ... +80 dB.**

The command sets the step width by which the starting power of the carriers in the defined carrier range will be incremented.

**Example:** "BB:ARB:MCAR:EDIT:CARR:POW -80dB"  
 'sets a power of -80 dB for the carriers in the carrier range.  
 "BB:ARB:MCAR:EDIT:CARR:POW:STEP 1 dB"  
 'the power is incremented by 1dB for each carrier, i.e. the first carrier has -80dB, the second -79dB, etc.

*RST value	Resolution	Options	SCPI
0 dB	0.01 dB	B10/B11 and B13 SOURce2 only with second option B9/B10/B11	Device-specific

**[SOURce<[1]|2>:]BB:ARB:MCARrier:EDIT:CARRier:STARt <carrier\_index>**

The command selects the first carrier in the carrier range to which the settings with the SOUR:BB:ARB:MCAR:EDIT:CARR: . . . commands shall apply.

**Example:** "BB:ARB:MCAR:EDIT:CARR:STAR 1"  
 'the carrier range starts at carrier 1.

*RST value	Resolution	Options	SCPI
0		B10/B11 and B13 SOURce2 only with second option B9/B10/B11	Device-specific

**[SOURce<[1]|2>:]BB:ARB:MCARrier:EDIT:CARRier:STATe ON | OFF**

The command switches all the carriers in the selected carrier range on or off.

**Example:** "BB:ARB:MCAR:EDIT:CARR:STAT ON"  
 'sets all the carriers in the carrier range to ON.

*RST value	Resolution	Options	SCPI
ON	-	B10/B11 and B13 SOURce2 only with second option B9/B10/B11	Device-specific

**[SOURce<[1]|2>:]BB:ARB:MCARrier:EDIT:CARRier:STOP <carrier\_index>**

The command selects the last carrier in the carrier range to which the settings with the :BB:ARB:MCAR:EDIT:CARR: . . . commands shall apply.

**Example:** "BB:ARB:MCAR:EDIT:CARR:STOP 4"  
 'the carrier range stops at carrier 4.

*RST value	Resolution	Options	SCPI
0		B10/B11 and B13 SOURce2 only with second option B9/B10/B11	Device-specific

**[SOURce<[1]|2>:]BB:ARB:MCARrier:OFILe <file\_name>**

This command defines the output file name for the multi-carrier waveform. This file name is used when a waveform is calculated (command SOUR:BB:ARB:MCAR:CLOad or SOUR:BB:ARB:MCAR:CREate). The file extension is \*.wv.

This command triggers an event and therefore has no \*RST value and no query form.

**Example:**           "MMEM:CDIR 'D:\user\waveform"  
                      'sets the default directory to D:\user\waveform.  
  
                      "BB:ARB:MCAR:OFIL 'mcar1\_2'"  
                      'defines the file name mcar1\_2.wv for the multi-carrier waveform file.

*RST value	Resolution	Options	SCPI
-	-	B10/B11 and B13 SOURce2 only with second option B9/B10/B11	device-specific

**[SOURce<[1]|2>:]BB:ARB:MCARrier:PRESet**

The command sets all ARB multi-carrier parameters to their default values.

This command triggers an event and therefore has no \*RST value and no query form.

**Example:**           "BB:ARB:MCAR:PRES"  
                      'resets the ARB multi-carrier parameters to default values.

*RST value	Options	Dependency	SCPI
-	B10/B11 and B13 SOURce2 only with second option B9/B10/B11	SOUR:BB:ARB:MCAR:COUN 0 SOUR:BB:ARB:MCAR:SPAC 0	Device-specific

**[SOURce<[1]|2>:]BB:ARB:MCARrier:SAMPles**

The command queries the resulting file size. The file size is returned in samples.

This command is a query and therefore has no \*RST value.

**Example:**           "BB:ARB:MCAR:SAMP?"  
                      'queries the file size of the currently calculated multi-carrier waveform.

*RST value	Resolution	Options	SCPI
-		B10/B11 and B13 SOURce2 only with second option B9/B10/B11	Device-specific

**[SOURce<[1]|2>:]BB:ARB:MCARrier:SETTing:CATalog?**

This command queries the available settings files in the specified default directory. The settings files are used to set the ARB multi-carrier submenu. Only files with the file extension **\*.arb\_multcarr** will be listed.

The command is a query command and therefore has no \*RST value.

**Example:** "MMEM:CDIR 'D:\user\waveform"  
 'sets the default directory to D:\user\waveform.  
 "BB:ARB:MCAR:SETT:CAT?"  
 'reads out all the settings files in the default directory.  
 Response: "mcar1, mcar2"  
 'the directory D:\user\waveform contains the configuration files  
 'mcar1.arb\_multcarr' and 'mcar2.arb\_multcarr'.

*RST value	Resolution	Options	SCPI
-	-	B10/B11 and B13 SOURce2 only with second option B9/B10/B11	device-specific

**[SOURce<[1]|2>:]BB:ARB:MCARrier:SETTing:LOAD <file\_name>**

The command loads the settings file in the default directory. A path can also be specified, in which case the files in the specified directory are selected. If a settings file with the specified name does not yet exist, it is created. The file extension may be omitted. Only files with the file extension **\*.arb\_multcarr** will be loaded or created.

**Example:** "MMEM:CDIR 'D:\user\waveform"  
 'sets the default directory to D:\user\waveform.  
 "BB:ARB:MCAR:SETT:LOAD 'new' "  
 'creates settings file new.arb\_multcarr in the default directory.

*RST value	Resolution	Options	SCPI
-	-	B10/B11 and B13 SOURce2 only with second option B9/B10/B11	device-specific

**[SOURce<[1]|2>:]BB:ARB:MCARrier:SETTing:STORE <file\_name>**

The command stores the current settings of submenu **ARB Multi-Carrier** in a file in the default directory. A path can also be specified, in which case the files are stored in the specified directory. The file extension may be omitted, the files are stored with the file extension **\*.arb\_multcarr**.

**Example:** "MMEM:CDIR 'D:\user\waveform"  
 'sets the default directory to D:\user\waveform.  
 "BB:ARB:MCAR:SETT:STOR 'mcar2' "  
 'stores settings file mcar2.arb\_multcarr in the default directory.

*RST value	Resolution	Options	SCPI
-	-	B10/B11 and B13 SOURce2 only with second option B9/B10/B11	device-specific

[SOURce<[1]|2>:]BB:ARB:MCARrier:TIME 1E-12s ... 1E9s

The command sets the user-defined signal period. This setting is only possible for Signal Period Mode User (BB:ARB:MCAR:TIME:MODE USER).

**Example:** "BB:ARB:MCAR:TIME:MODE USER"  
'selects Signal Period Mode User.  
  
"BB:ARB:MCAR:TIME 10 s"  
'sets a signal period of 10 seconds.

*RST value	Resolution	Options	SCPI
0		B10/B11 and B13 SOURce2 only with second option B9/B10/B11	device-specific

[SOURce<[1]|2>:]BB:ARB:MCARrier:TIME:MODE LONG | SHORT | USER

The command selects the mode for calculating the resulting signal period of the multi-carrier waveform. The resulting period is always calculated for all carriers in the carrier table irrespective of their state (ON/OFF).

**Parameter: LONG**  
The resulting signal period is defined by the longest I/Q file in the carrier table. Shorter I/Q files are periodically repeated.

**SHORT**  
The resulting signal period is defined by the shortest I/Q file in the carrier table. Only the first part of longer I/Q files is used.

**USER**  
The signal period can be set with command SOUR:BB:ARB:MCARr:TIME. Shorter I/Q files are repeated periodically, and only the first part of longer I/Q files is used.

**Example:** "BB:ARB:MCAR:TIME:MODE LONG"  
'selects signal period mode long.

*RST value	Resolution	Options	SCPI
LONG		B10/B11 and B13 SOURce2 only with second option B9/B10/B11	device-specific

**[SOURce<[1]|2>:]BB:ARB:PRESet**

The command sets all ARB generator parameters to their default values.

This command triggers an event and therefore has no \*RST value and no query form.

**Example:** "BB:ARB:PRES"  
 'resets the ARB generator to default values.

*RST value	Options	Dependency	SCPI
-	B10/B11 and B13 SOURce2 only with second option B9/B10/B11	SOUR:BB:ARB:CLOC 1MHz SOUR:BB:ARB:CLOC:DEL 0 SOUR:BB:ARB:CLOC:SOUR INT SOUR:BB:ARB:SIGN:FREQ 1 kHz SOUR:BB:ARB:SIGN:POFF 90 DEG SOUR:BB:ARB:SIGN:SAMPL 100 SOUR:BB:ARB:STAT OFF SOUR:BB:ARB:TRIG:EXT:DEL 0 SOUR:BB:ARB:TRIG:EXT:INH 0 SOUR:BB:ARB:TRIG:OUTP<n>:STAT OFF SOUR:BB:ARB:TRIG:OUTP<n>:SHIF 0 SOUR:BB:ARB:TRIG:OUTP<n>:MODE REST SOUR:BB:ARB:TRIG:OUTP<n>:PFR 1MHz SOUR:BB:ARB:TRIG:OUTP<n>:PATT #H0,1 SOUR:BB:ARB:TRIG:OUTP<n>:OFFT 1 SOUR:BB:ARB:TRIG:OUTP<n>:ONT 1 SOUR:BB:ARB:TRIG:SEQ AUTO SOUR:BB:ARB:TRIG:SOUR INT	Device-specific



[SOURce<[1]|2>:]BB:ARB:SEQUence AUTO | RETRigger | AAUTo | ARETrigger | SINGle

The command selects the trigger mode.

**Parameter:**       **AUTO**  
                           The waveform is output continuously.

**RETRigger**  
                           The waveform is output continuously. A trigger event (internal or external) causes a restart.

**AAUTo**  
                           The waveform is output only when a trigger event occurs. After the trigger event the waveform is output continuously. Waveform output is stopped with command SOUR:BB:ARB:TRIG:ARM:EXEC and started again when a trigger event occurs.

**ARETrigger**  
                           The waveform is output only when a trigger event occurs. The device automatically toggles to RETRIG mode. Every subsequent trigger event causes a restart. Waveform output is stopped with command SOUR:BB:ARB:TRIG:ARM:EXEC and started again when a trigger event occurs.

**SINGle**  
                           The waveform is output only when a trigger event occurs. After the trigger event the waveform is output once to the set sequence length (SOUR:BB:ARB:TRIG:SLEN). Every subsequent trigger event causes a restart.

**Example:**           "BB:ARB:SEQ AAUT"  
                           'sets the **Armed\_auto** trigger mode; the device waits for the first trigger (e.g. with \*TRG) and then generates the signal continuously.

*RST value	Resolution	Options	SCPI
RETRigger	-	B10/B11 and B13 SOURce2 only with second option B9/B10/B11	Device-specific

[SOURce<[1]|2>:]BB:ARB:STATe ON | OFF

The command switches the ARB generator on. Any other standards or digital modulation that may be in the ON state are automatically turned OFF. ARB:STAT ON is only possible after the selection of a waveform. The selected waveform is output straight away (ARB:SEQ AUTO|RETRigger) or after the first trigger event (ARB:SEQ AAUT|ARET), depending on the trigger setting.

**Example:**           "BB:ARB:WAV:SEL 'wave1'"  
                           'loads waveform file 'wave1.wv' from the default directory.  
                           "BB:ARB:TRIG:SEQ RETR"  
                           'sets trigger mode Retrigger.  
                           "BB:ARB:STAT ON"  
                           'switches on the ARB generator for path A. The selected waveform is output straight away. A trigger event causes signal output to restart.

*RST value	Resolution	Options	Dependency	SCPI
OFF	-	B10/B11 and B13 SOURce2 only with second option B9/B10/B11	ARB:STAT ON switches off other standards and digital modulation on the same path (SOURce1 or SOURce2).	Device-specific

**[SOURce<[1]|2>:]BB:ARB:TRIGger:ARM:EXECute**

The command stops waveform output for trigger modes Armed\_Auto and Armed\_Retrigger. A subsequent internal or external trigger event restart waveform output.

This command triggers an event and therefore has no \*RST value and no query form.

**Example:**       "BB:ARB:TRIG:SOUR INT"  
                  'sets internal triggering.

                  "BB:ARB:TRIG:SEQ ARET"  
                  'sets Armed\_Retrigger mode, i.e. every trigger event causes waveform output to restart.

                  "BB:ARB:TRIG:EXEC"  
                  'executes a trigger, waveform output is started.

                  "BB:ARB:TRIG:ARM:EXEC"  
                  'waveform output is stopped.

                  "BB:ARB:TRIG:EXEC"  
                  'executes a trigger, waveform output is started again.

*RST value	Resolution	Options	SCPI
-	1	B10/B11 and B13 SOURce2 only with second option B9/B10/B11	Device-specific

**[SOURce<[1]|2>:]BB:ARB:TRIGger:EXECute**

The command executes a trigger. The internal trigger source must be selected using the command ARB:TRIGger:SOURce INTernal and a trigger mode other than AUTO must be selected using the command :ARB:SEQuence.

This command triggers an event and therefore has no \*RST value and no query form.

**Example:**       "BB:ARB:TRIG:SOUR INT"  
                  'sets internal triggering.

                  "BB:ARB:SEQ RETR"  
                  'sets Retrigger mode, i.e. every trigger event causes signal output to restart.

                  "BB:ARB:TRIG:EXEC"  
                  'executes a trigger.

*RST value	Resolution	Options	SCPI
-	1	B10/B11 and B13 SOURce2 only with second option B9/B10/B11	Device-specific

**[SOURce<[1]|2>:]BB:ARB:TRIGger[:EXTErnal<[1]|2>]:DELay 0 ... 2<sup>32</sup>-1 samples**

The command specifies the trigger delay (expressed as a number of samples) for external triggering. The numeric suffix to EXTErnal distinguishes between the external trigger via the TRIGGER 1 (suffix 1) and TRIGGER 2 (suffix 2) connector.

**Example:** "BB:ARB:TRIG:SOUR EXT"  
 'selects an external trigger via the TRIGGER 1 connector.  
 "BB:ARB:TRIG:DEL 200"  
 'sets a delay of 200 samples for the trigger.

*RST value	Resolution	Options	SCPI
0	1	B10/B11 and B13 SOURce2 only with second option B9/B10/B11	Device-specific

**[SOURce<[1]|2>:]BB:ARB:TRIGger[:EXTErnal<[1]|2>]:INHibit 0 ... 2<sup>32</sup>-1 samples**

The command specifies the number of samples by which a restart is to be inhibited following a trigger event. This command applies only in the case of external triggering. The numeric suffix to EXTErnal distinguishes between the external trigger via the TRIGGER 1 (suffix 1) and TRIGGER 2 (suffix 2) connector.

**Example:** "BB:ARB:TRIG:SOUR EXT"  
 'selects an external trigger via the TRIGGER 1 connector.  
 "BB:ARB:TRIG:INH 200"  
 'sets a restart inhibit for 200 samples following a trigger event.

*RST value	Resolution	Options	SCPI
0	1	B10/B11 and B13 SOURce2 only with second option B9/B10/B11	Device-specific

**[SOURce<[1]|2>:]BB:ARB:TRIGger:OBASeband:DELay 0 ... 2<sup>32</sup>-1 samples**

The command specifies the trigger delay (expressed as a number of samples) for triggering by the signal from the second path (two-path instruments only).

**Example:** "BB:ARB:TRIG:SOUR OBAS"  
 'sets for path A the internal trigger executed by the signal from the second path (path B).  
 "BB:ARB:TRIG:DEL 200"  
 'sets a delay of 200 samples for the trigger.

*RST value	Resolution	Options	SCPI
0	1	B10/B11 and B13 SOURce2 only with second option B9/B10/B11	Device-specific

[SOURce<[1]|2>:]BB:ARB:TRIGger:OBASeband:INHibit 0 ... 2<sup>32</sup>-1 samples

The command specifies the number of samples by which a restart is to be inhibited following a trigger event. This command applies only for triggering by the second path (two-path instruments only).

**Example:** "BB:ARB:TRIG:SOUR OBAS"  
 'sets for path A the internal trigger executed by the signal from the second path (path B).  
 "BB:ARB:TRIG:INH 200"  
 'sets a restart inhibit for 200 samples following a trigger event.

*RST value	Resolution	Options	SCPI
0	1	B10/B11 and B13 SOURce2 only with second option B9/B10/B11	Device-specific

[SOURce<[1]|2>:]BB:ARB:TRIGger:OUTPut<[1]...4>:DELay 0 ... 2<sup>20</sup>-1 Symbols

The command defines the delay between the signal on the marker outputs and the start of the signals, expressed in terms of samples. Command :BB:ARB:TRIGger:OUTPut:DELay:FIXed ON can be used to restrict the range of values to the dynamic range, i.e. the range within which a delay of the marker signals can be set without restarting the marker and signal.

**Example:** "BB:ARB:TRIG:OUTP2:DEL 16"  
 'sets a delay of 16 samples for the signal on connector MARKER 2.

*RST value	Resolution	Options	SCPI
0 Symbols	1	B10/B11 and B13 SOURce2 only with second option B9/B10/B11	Device-specific

[SOURce<[1]|2>:]BB:ARB:TRIGger:OUTPut:DELay:FIXed ON | OFF

The command restricts the marker delay setting range to the dynamic range. In this range the delay can be set without restarting the marker and signal. If a delay is entered in setting ON but is outside this range, the maximum possible delay is set and an error message is output.

The numeric suffix in OUTPut has no significance for this command, since the setting always affects every marker.

**Example:** "BB:ARB:TRIG:OUTP:DEL:FIX ON"  
 'restricts the marker signal delay setting range to the dynamic range.

*RST value	Resolution	Options	SCPI
OFF	-	B10/B11 and B13 SOURce2 only with second option B9/B10/B11	Device-specific

**[SOURce<[1]|2>:]BB:ARB:TRIGger:OUTPut<[1]...4>:DELay:MAXimum**

The command queries the maximum marker delay for setting :BB:ARB:TRIGger:OUTPut:DELay:FIXed ON.

The command is a query only and therefore has no \*RST value.

**Example:** "BB:ARB:TRIG:OUTP:DEL:FIX ON"  
 'restricts the marker signal delay setting range to the dynamic range.  
 "BB:ARB:TRIG:OUTP:DEL:MAX"  
 'queries the maximum of the dynamic range.  
 Response: "2000"  
 'the maximum for the marker delay setting is 2000 samples.

*RST value	Resolution	Options	SCPI
-	-	B10/B11 and B13 SOURce2 only with second option B9/B10/B11	Device-specific

**[SOURce<[1]|2>:]BB:ARB:TRIGger:OUTPut<[1]...4>:DELay:MINimum**

The command queries the minimum marker delay for setting :BB:ARB:TRIGger:OUTPut:DELay:FIXed ON..

The command is a query only and therefore has no \*RST value.

**Example:** "BB:ARB:TRIG:OUTP:DEL:FIX ON"  
 'restricts the marker signal delay setting range to the dynamic range.  
 "BB:ARB:TRIG:OUTP:DEL:MIN"  
 'queries the minimum of the dynamic range.  
 Response: "0"  
 'the minimum for the marker delay setting is 0 samples.

*RST value	Resolution	Options	SCPI
-	-	B10/B11 and B13 SOURce2 only with second option B9/B10/B11	Device-specific

**[SOURce<[1]2>:]BB:ARB:TRIGger:OUTPut<[1]...4>:MODE**

UNCHanged | REStart | PULSe | PATtern | RATio

The command defines the signal for the selected marker output.

**Parameter:**       **UNCHanged**  
                           A marker signal as defined in the waveform file (tag 'marker mode x') is generated.

**REStart**  
                           A marker signal is generated at every waveform start.

**PULSe**  
                           A pulsed marker signal is generated. The pulse frequency (= symbol rate/divider) is defined with the SOUR:BB:ARB:TRIG:OUTP:PULS:DIV command and can be queried with the SOUR:BB:ARB:TRIG:OUTP:PULS:FREQ? command.

**PATtern**  
                           A marker signal is generated with the aid of a user-definable bit pattern. The bit pattern is entered with the aid of command :BB:ARB:TRIGger:OUTPut:PATtern . The bit pattern is a maximum of 32 bits long.

**RATio**  
                           A regular marker signal corresponding to the Time Off / Time On specifications in the commands :ARB:TRIGger:OUTPut:OFFTime and :ARB:TRIGger:OUTPut:ONTime is generated.

**Example:**           "BB:ARB:TRIG:OUTP2:MODE PULS"  
                           'selects the pulsed marker signal on output MARKER 2.  
                           "BB:ARB:TRIG:OUTP2:STAT ON"  
                           'activates the pulsed marker signal on output MARKER 2.

*RST value	Resolution	Options	SCPI
REStart	-	B10/B11 and B13 SOURce2 only with second option B9/B10/B11	Device-specific

**[SOURce<[1]|2>:]BB:ARB:TRIGger:OUTPut<[1]...4>:OFFTime 1 ... max. wavelength -1 sample**

The command sets the number of samples in a period (ON time + OFF time) during which the marker signal in setting :ARB:TRIGger:OUTPut:MODE RATio on the marker outputs is OFF.

**Example:** "BB:ARB:TRIG:OUTP2:OFFT 20"  
 'sets an OFF time of 20 samples for marker signal 2 on path A.

*RST value	Resolution	Options	SCPI
1	1	B10/B11 and B13 SOURce2 only with second option B9/B10/B11	Device-specific

**[SOURce<[1]|2>:]BB:ARB:TRIGger:OUTPut<[1]...4>:ONTime 1 ... max. wavelength -1 sample**

The command sets the number of samples in a period (ON time + OFF time) during which the marker signal in setting :ARB:TRIGger:OUTPut:MODE RATio on the marker outputs is ON.

**Example:** "BB:ARB:TRIG:OUTP2:ONT 20"  
 'sets an ON time of 20 samples for marker 2 on path A.

*RST value	Resolution	Options	SCPI
1	1	B10/B11 and B13 SOURce2 only with second option B9/B10/B11	Device-specific

**[SOURce<[1]|2>:]BB:ARB:TRIGger:OUTPut<[1]...4>:PATTern #B0,1 ... #B111...1,32**

The command defines the bit pattern used to generate the marker signal in the setting SOURce:BB:ARB:TRIGger:OUTPut:MODE PATTern 0 is marker off, 1 is marker on.

**Example:** "BB:ARB:TRIG:OUTP2:PATT #H39FE0000,32"  
 'sets a bit pattern.  
 "BB:ARB:TRIG:OUTP2:MODE PATT"  
 'activates the marker signal according to a bit pattern on output MARKER 2.

*RST value	Resolution	Options	SCPI
0		B10/B11 and B13 SOURce2 only with second option B9/B10/B11	Device-specific

**[SOURce<[1]|2>:]BB:ARB:TRIGger:OUTPut<[1]...4>:PULSe:DIVider 2 ... 2^10**

The command sets the divider for the pulsed marker signal in the setting SOURce:BB:ARB:TRIGger:OUTPut:MODE PULSe. The pulse frequency is derived by dividing the symbol rate by the divider.

**Example:** "BB:ARB:TRIG:OUTP2:PULS:DIV 2"  
 'sets the divider for the path A marker signal on output MARKER 2 to the value 2.  
 "BB:ARB:TRIG:OUTP2:FREQ?"  
 'queries the resulting pulse frequency of the marker signal.  
 Response: "66 000"  
 'the resulting pulse frequency is 66 kHz.

*RST value	Resolution	Options	SCPI
2	1	B10/B11 and B13 SOURce2 only with second option B9/B10/B11	Device-specific

**[SOURce<[1]|2>:]BB:ARB:TRIGger:OUTPut<[1]...4>:PULSe:FREQuency?**

The command queries the pulse frequency of the pulsed marker signal in the setting SOURce:BB:ARB:TRIGger:OUTPut:MODE PULSe. The pulse frequency is derived by dividing the symbol rate by the divider. The divider is defined with command :BB:ARB:TRIG:OUTP:PULS:DIV.

The command is a query only and therefore has no \*RST value.

**Example:** "BB:ARB:TRIG:OUTP2:PULS:DIV 4"  
 'sets the divider for the path A marker signal on output MARKER 2 to the value 4.  
 "BB:ARB:TRIG:OUTP2:MODE PULS"  
 'enables the pulsed marker signal.  
 "BB:ARB:TRIG:OUTP2:PULS:FREQ?"  
 'queries the pulse frequency of the marker signal.  
 Response: "33 000"  
 'the resulting pulse frequency is 33 kHz.

*RST value	Resolution	Options	SCPI
-	-	B10/B11 and B13 SOURce2 only with second option B9/B10/B11	Device-specific



**[SOURce<[1]>:]BB:ARB:TRIGger:RMODE**

The command queries the status of waveform output or all trigger modes with ARB on.

The command is a query command and therefore has no \*RST value.

**Parameter: RUN**

the waveform is output. A trigger event occurred in the triggered mode.

**STOP**

the waveform is not output. A trigger event did not occur in the triggered modes, or waveform output was stopped by the command  
:BB:ARB:TRIG:ARM:EXECute (armed trigger modes only).

**Example:**

"SOUR2:BB:ARB:TRIG:SOUR EXT"

'sets external triggering via the TRIGGER 1 connector for path B of a two-path instrument.

"SOUR2:BB:ARB:TRIG:MODE ARET"

'selects the Armed\_Retrigger mode.

"SOUR2:BB:ARB:TRIG:RMODE?"

'queries the current status of waveform output.

Response: "RUN"

'the waveform is output, an external trigger was executed.

*RST value	Resolution	Options	SCPI
-	-	B10/B11 and B13 SOURce2 only with second option B9/B10/B11	Device-specific

**[SOURce<[1]>:]BB:ARB:TRIGger:SLENgth 1 ... (2^32-1) Samples**

The command defines the length of the signal sequence to be output in the **Single** trigger mode.

The unit is defined with command SOUR:BB:ARB:TRIG:SLUNit. It is possible to output deliberately just part of the waveform, an exact sequence of the waveform, or a defined number of repetitions of the waveform.

**Example:**

"SOUR2:BB:ARB:SEQ SING"

'sets trigger mode Single.

"SOUR2:BB:ARB:TRIG:SLUN SAMP"

'sets unit Samples for the entry of sequence length.

"SOUR2:BB:ARB:TRIG:SLEN 200"

'sets a sequence length of 200 samples. The first 200 samples of the current waveform will be output after the next trigger event.

*RST value	Resolution	Options	SCPI
1 Waveform length	-	B10/B11 and B13 SOURce2 only with second option B9/B10/B11	Device-specific

[SOURce<[1]|2>:]BB:ARB:TRIGger:SLUNit SAMPLE | SEQUENCE

The command defines the unit for the entry of the length of the signal sequence (SOUR:BB:ARB:TRIG:SLEN) to be output in the **Single** trigger mode (SOUR:BB:ARB:SEQ SING).

**Example:** "SOUR:BB:ARB:SEQ SING"  
 'sets trigger mode Single.

"SOUR:BB:ARB:TRIG:SLUN SEQ"  
 'sets unit Sequence length for the entry of sequence length.

"SOUR:BB:ARB:TRIG:SLEN 2"  
 'sets a sequence length of 2 waveforms. The current waveforms will be output twice after the next trigger event.

*RST value	Resolution	Options	SCPI
SEQUENCE	-	B10/B11 and B13 SOURce2 only with second option B9/B10/B11	Device-specific

[SOURce<[1]|2>:]BB:ARB:TRIGger:SMODE SAME | NEXT | NSEAm

The command selects the extended trigger mode for multi-segment waveforms.

**Parameter: SAME**  
 The currently selected segment is output repeatedly.

**NEXT**  
 The current segment ceases to be output as soon as a new segment is entered with command :BB:ARB:WSEG:NEXT and the new segment starts to be output after a system-imposed signal gap.

**NSEAm**  
 The segment selected with command :BB:ARB:WSEG:NEXT is not output until the whole of the current segment has been output (wrap around). In this case the signal transition is seamless.

**Example:** "SOUR2:BB:ARB:SEQ AUTO"  
 'selects trigger mode AUTO.

"SOUR2:BB:ARB:TRIG:SMOD SAME"  
 'the same segment of the waveform is output repeatedly.

*RST value	Resolution	Options	SCPI
NEXT	-	B10/B11 and B13 SOURce2 only with second option B9/B10/B11	Device-specific

[SOURce<[1]|2>:]BB:ARB:TRIGger:SOURce INTernal | EXTernal | BEXTernal | OBASeband

The command selects the trigger source.

**Parameter:**     **INTernal**  
 Triggering is executed by means of the Trigger command in the case of remote control, and by means of **Execute Trigger** in the case of manual operation.

**EXTernal**  
 Triggering is executed by means of the signal on the TRIGGER 1 connector.

**BEXTernal**  
 Triggering is executed by means of the signal on the TRIGGER 2 connector.

**OBASeband**  
 Triggering is executed by means of the signal from the second path (two-path instruments only).

**Example:**       "BB:ARB:TRIG:SOUR INT"  
                   'sets internal triggering.

*RST value	Resolution	Options	SCPI
INTernal	-	B10/B11 and B13 SOURce2 only with second option B9/B10/B11	Device-specific

[SOURce<[1]|2>:]BB:ARB:TSIGnal:SINE:FREQUency 100 Hz ... 25 MHz

The command sets the frequency of the simple sinusoidal test signal. This signal is used as output via the I channel. A sine wave of the same frequency but optionally phase-shifted is generated on the Q path (ARB:TSIGnal:SINE:POFFset).

**Example:**       "BB:ARB:TSIG:SINE:FREQ 100 kHz"  
                   'sets a sine signal of 100 kHz.

*RST value	Resolution	Options	SCPI
1 kHz	0.01 Hz	B10/B11 and B13 SOURce2 only with second option B9/B10/B11	Instrument-specific

[SOURce<[1]|2>:]BB:ARB:TSIGnal:SINE:PHASe -180.00 Deg ... + 180.00 Deg

The command sets the phase offset of the sine wave on the Q channel relative to the sine wave on the I channel.

**Example:**       "BB:ARB:TSIG:SINE:PHAS 90"  
                   'sets a phase offset of 90 degrees.

*RST value	Resolution	Options	SCPI
90 DEG	0.01 DEG	B10/B11 and B13 SOURce2 only with second option B9/B10/B11	Instrument-specific

[SOURce<[1]|2>:]BB:ARB:TSIGnal:SINE:SAMPles 3 ... 1000 samples per period

The command sets the sample rate for the sine signal in samples per period. The resulting clock rate must not exceed the maximum ARB clock rate of 100 MHz. The maximum value is automatically restricted by reference to the set frequency

**Example:** "BB:ARB:TSIG:SINE:SAMP 100"  
'sets a sample rate of 100 samples per period.

*RST value	Resolution	Options	Dependency	SCPI
100 samples per period	1	B10/B11 and B13 SOURce2 only with second option B9/B10/B11	ARB:SIGN:SAMP MAX is automatically restricted by frequency x samples <= 100 MHz	Instrument-specific

[SOURce<[1]|2>:]BB:ARB:WAVEform:CATalog? <path>

This command reads out the files in the default directory. The default directory is set using command MMEM:CDIRectory. A path can also be specified, in which case the files in the specified directory are read. When the names of the waveform files are returned they are separated by commas. Only files with the file extension \*.wv will be listed.

The command is a query command and therefore has no \*RST value.

**Example:** "MMEM:CDIR 'D:\user\waveform"  
'sets the default directory to D:\user\waveform.

"BB:ARB:WAV:CAT?"  
'reads out all the files in the default directory.

Response: "sin1, wave"  
'the directory D:\user\waveform contains the waveform files 'sin1.wv' and 'wave.wv'.

*RST value	Resolution	Options	SCPI
-	-	B10/B11 and B13 SOURce2 only with second option B9/B10/B11	Device-specific

[SOURce<[1]|2>:]BB:ARB:WAVEform:CATalog:LENGth? <path>

This command reads out the number of files in the default directory for waveform files (D:\Lists\ARBWave). A path can also be specified, in which case the number of files in the specified directory is read. Only files with the file extension \*.wv will be listed.

The command is a query command and therefore has no \*RST value.

**Example:** "BB:ARB:WAV:CAT:LENG?"  
'reads out the number of files in the default waveform directory.

Response: "1"  
'there is 1 file in the default waveform directory.

*RST value	Resolution	Options	SCPI
-	-	B10/B11 and B13 SOURce2 only with second option B9/B10/B11	Device-specific

**[SOURce<[1]|2>:]BB:ARB:WAVeform:DATA <waveform filename>[,<binary data block>]**

This command writes the block data <binary data block> to the file identified by <file\_name>. The IEC bus delimiter should be set to EOI when this is done, in order to ensure trouble-free data transmission.

The associated query command transmits the specified file from the R&S Vector Signal Generator to the control computer via the IEC bus . Please note that the buffer on the control computer must be big enough to accept the file. The setting for the IEC bus delimiter is of no significance.

Using this command, waveforms can be read out directly from or sent directly to the instrument.

The structure of the binary data block is as follows: #234<binarydata block>

# is always used to introduce the binary block

<number> states how many places in the following length data (in the example 2)

<number> defines the number of following bytes (in the example 34)

<binary data block> binary block data of the specified length.

Only the file name has to be entered, the file extension may be omitted. Waveform data is stored only in files with the specific file extensions \*.wv.

**Example:** "BB:ARB:WAV:DATA 'TEST1.WV',#3767<binary data block>"  
'writes the block data to file 'test1.wv'.

"BB:ARB:WAV:DATA? 'TEST1.WV'"  
'sends the data from file 'Test1.wv' from the R&S Vector Signal Generator to the control computer in the form of a binary block.

*RST value	Resolution	Options	SCPI
-	-	B10/B11 and B13 SOURce2 only with second option B9/B10/B11	Device-specific

**[SOURce<[1]|2>:]BB:ARB:WAVeform:DATA? <filename>,<tag>**

The command queries the content of the specified tag of the selected Waveform file (see following section "[R&S Vector Signal Generator Waveform and List Format](#)").

The command is a query command and therefore has no \*RST value.

**Parameter:** 'comment' | 'copyright' | 'date' | 'lcpfilter' | 'marker name' | 'poweroffset'

**Example:** "BB:ARB:WAV:TAG? 'Wave1.wv', 'comment'"  
'queries the content of the 'comment' tag of file wave1.wv.

Response: "Sine wave for test purposes"

*RST value	Resolution	Options	SCPI
-	-	B10/B11 and B13 SOURce2 only with second option B9/B10/B11	Device-specific

**[SOURce<[1]>:]BB:ARB:WAVeform:DELeTe <waveform filename>**

The command deletes the specified waveform file. If the file is not on the default path, the path must be specified at the same time. The file extension may be omitted. Only files with the file extension \*.wv will be deleted.

**Example:** "BB:ARB:WAV:DEL 'c:\user\wave1.wv'"  
 'deletes waveform file 'wave1.wv' from the c:/user directory.

*RST value	Resolution	Options	SCPI
-	-	B10/B11 and B13 SOURce2 only with second option B9/B10/B11	Device-specific

**[SOURce<[1]>:]BB:ARB:WAVeform:FREE?**

The command queries the free disk space on the default path of the R&S Vector Signal Generator harddisk.

The command is a query command and therefore has no \*RST value.

**Example:** "MMEM:CDIR 'D:\user\waveform'"  
 'sets the default directory to D:\user\waveform.'  
 "BB:ARB:WAV:FREE?"  
 'queries the free disk space in directory D:\user\waveform.'

*RST value	Resolution	Options	SCPI
-	-	B10/B11 and B13 SOURce2 only with second option B9/B10/B11	Device-specific

**[SOURce<[1]>:]BB:ARB:WAVeform:POINts? <waveform filename>**

The command queries the number of samples in the waveform file selected using command :ARB:WAV:SEL. Only the file name has to be entered. Only files with the file extension \*.wv will be read out.

The command is a query command and therefore has no \*RST value.

**Example:** "BB:ARB:WAV:POINt?"  
 'queries the number of I/Q values pairs in the waveform file.'  
 Response: "401"  
 'the waveform file contains 401 I/Q values pairs.'

*RST value	Resolution	Options	SCPI
-	-	B10/B11 and B13 SOURce2 only with second option B9/B10/B11	Device-specific

**[SOURce<[1]|2>:]BB:ARB:WAVeform:SElect <waveform filename>**

The command selects the waveform file. If the file is not on the default path, the path must be specified at the same time. If no file of the specified name exists, it is created. The file extension may be omitted. Only files with the file extension \*.wv will be created or loaded.

**Example:**       "BB:ARB:WAV:SEL 'c:\user\wave1.wv'"  
                   'selects waveform file 'wave1.wv' from the c:/user directory and loads it.

                  "BB:ARB:TRIG:SEQ AAUT"  
                   'sets trigger mode Armed\_Auto.

                  "BB:ARB:TRIG:SOUR INT"  
                   'selects internal triggering.

                  "BB:ARB:STAT ON"  
                   'switches on the ARB generator for path A.

                  "BB:ARB:TRIG:EXEC"  
                   'starts generating the selected waveform in path A.

*RST value	Resolution	Options	SCPI
-	-	B10/B11 and B13 SOURce2 only with second option B9/B10/B11	Device-specific

**[SOURce<[1]|2>:]BB:ARB:WAVeform:TAG? <tag name>**

The command queries the content of the specified tag of the selected Waveform file (see following section "[R&S Vector Signal Generator Waveform and List Format](#)").

The command is a query command and therefore has no \*RST value.

**Example:**       "BB:ARB:WAV:TAG? 'comment'"  
                   'queries the content of the 'comment' tag.

                  Response: "Sine wave for test purposes"

*RST value	Resolution	Options	SCPI
-	-	B10/B11 and B13 SOURce2 only with second option B9/B10/B11	Device-specific

**[SOURce<[1]|2>:]BB:ARB:WSEgment?**

This command queries the currently output segment of the multi-segment waveform.

The command is a query command and therefore has no \*RST value.

**Example:**       "BB:ARB:WSEG?"  
                   'queries the currently output segment.

                  Response "2"  
                   'segment 2 is currently output.

*RST value	Resolution	Options	SCPI
-	-	B10/B11 and B13 SOURce2 only with second option B9/B10/B11	Device-specific

**[SOURce<[1]|2>:]BB:ARB:WSEgment:CLOad <configuration file\_name>**

This command creates a multi-segment waveform using the current entries of the specified configuration file.

This multi-segment waveform is saved with the file name specified in the configuration file . The file extension is \*. **wv**. Digital standard **ARB** is activated, the new multi-segment waveform is loaded and the first segment is output in accordance to the trigger settings.

This command triggers an event and therefore has no \*RST value and no query form.

**Example:**

```
"MMEM:CDIR 'D:\user\waveform"
'sets the default directory to D:\user\waveform.

"BB:ARB:WSEG:CONF:SEL 'multi_sin'"
'creates the configuration file multi_sin.inf_mswv in the default directory.

"BB:ARB:WSEG:CONF:SEGM:APP 'sinus1'"
'includes waveform sinus1.wv as segment 1 in the configuration file. The
waveform must be available in the default directory.

"BB:ARB:WSEG:CONF:SEGM:APP 'sinus2'"
'includes waveform sinus1.wv as segment 2 in the configuration file. The
waveform must be available in the default directory.

"BB:ARB:WSEG:CONF:OFIL 'mseg1_2'"
'defines the file name mseg1_2.wv for the multi-segment waveform.

"BB:ARB:WSEG:CLO 'multi_sin'"
'creates multi-segment waveform mseg1_2.wv using the settings of the
configuration file multi_sin.inf_mswv.
The new multi-segment waveform is loaded and digital standard ARB is
activated.
```

*RST value	Options	Dependencies	SCPI
-	B10/B11 and B13 SOURce2 only with second option B9/B10/B11	SOUR:BB:ARB:WAV:SEL = <new Waveform> SOUR:BB:ARB:STAtE = ON	device-specific

**[SOURce<[1]|2>:]BB:ARB:WSEgment:CONFigure:CATalog?**

This command queries the available configuration files in the specified default directory. The configuration files are used to create multi-segment waveform files.

The command is a query command and therefore has no \*RST value.

**Example:**

```
"MMEM:CDIR 'D:\user\waveform"
'sets the default directory to D:\user\waveform.

"BB:ARB:WSEG:CONF:CAT?"
'reads out all the configuration files in the default directory.

Response: "multit1, multi2"
'the directory D:\user\waveform contains the configuration files
'multit1.inf_mswv' and 'multi2.inf_mswv'.
```

*RST value	Resolution	Options	SCPI
-	-	B10/B11 and B13 SOURce2 only with second option B9/B10/B11	device-specific



**[SOURce<[1]>:]BB:ARB:WSEgment:CONFigure:CLOCK max sample rate .. 100MHz**

This command defines the clock rate used for multisegment waveform output in case of Clock Mode **User** (:BB:ARB:WSEG:CONF:CLOCK:MODE USER).

**Example:** "BB:ARB:WSEG:CONF:CLOC:MODE USER"  
'selects Clock Mode User.

"BB:ARB:WSEG:CONF:CLOC 50MHz"  
'defines a clock rate of 50 MHz.

*RST value	Resolution	Options	SCPI
Max. Sample Rate	0.001 Hz	B10/B11 and B13 SOURce2 only with second option B9/B10/B11	device-specific

**[SOURce<[1]>:]BB:ARB:WSEgment:CONFigure:CLOCK:MODE UNCHanged | HIGHest | USER**

This command selects the clock rate mode for the multi-segment waveform.

**Parameter:** **UNCHanged**

The segments are output with the clock rate defined in the waveform file. Extended Trigger Mode **Next Segment Seamless** (:BB:ARB:TRIG:SMOD NSEam) can only be selected if all segments have the same clock rate. Extended Trigger Mode **Next Segment** (:BB:ARB:TRIG:SMOD NEXT) can only be selected if trigger mode **Internal** is selected. (:BB:ARB:TRIG:SOUR INT).

**HIGHest**

The segments are output at the highest available clock rate.

**USER**

The segments are output with the clock rate defined with command :BB:ARB:WSEG:CONF:CLOC.

**Example:** "BB:ARB:WSEG:CONF:CLOC:MODE UNCH"  
'selects clock mode unchanged. The segments are output with the clock rate defined in the waveform file.

*RST value	Resolution	Options	SCPI
UNCHanged	-	B10/B11 and B13 SOURce2 only with second option B9/B10/B11	device-specific

**[SOURce<[1]>:]BB:ARB:WSEgment:CONFigure:COMMeNT <string>**

This command enters a comment for the configuration file. The configuration file must be specified with command :BB:ARB:WSEG:CONF:SEL.

**Example:** "BB:ARB:WSEG:CONF:COMM <3gpp\_up>"  
'enters comment "3gpp\_up".

*RST value	Resolution	Options	SCPI
		B10/B11 and B13 SOURce2 only with second option B9/B10/B11	device-specific

**[SOURce<[1]|2>:]BB:ARB:WSEGment:CONFigure:DELete**

This command deletes the configuration file. The configuration files are used to create multi-segment waveform files.

This command triggers an event and therefore has no \*RST value and no query form.

**Example:** "MMEM:CDIR 'D:\user\waveform"  
 'sets the default directory to D:\user\waveform.  
 "BB:ARB:WSEG:CONF:DEL 'multil'"  
 'deletes configuration file multil.inf\_mswv.

*RST value	Resolution	Options	SCPI
-	-	B10/B11 and B13 SOURce2 only with second option B9/B10/B11	device-specific

**[SOURce<[1]|2>:]BB:ARB:WSEGment:CONFigure:LEVel[:MODE] UNCHanged | ERMS**

This command selects the level mode for the multi-segment waveform.

**Parameter: UNCHanged**  
 The segments are output exactly as defined in the files.

**ERMS**  
 The segments are output so that all segments have the same rms value.

**Example:** "BB:ARB:WSEG:CONF:LEV:MODE UNCH"  
 'selects level mode unchanged. The segments are output as defined in the waveform file.

*RST value	Resolution	Options	SCPI
UNCHanged	-	B10/B11 and B13 SOURce2 only with second option B9/B10/B11	device-specific

**[SOURce<[1]2>:]BB:ARB:WSEgment:CONFigure:OFILe <file\_name>**

This command defines the file name for the multi-segment waveform. This file name is stored in the configuration file and is used when a waveform is created (command :BB:ARB:WSEG:CLOad or :BB:ARB:WSEG:CREate). The file extension is \*.wv.

This command triggers an event and therefore has no \*RST value and no query form.

**Example:**  
 "MMEM:CDIR 'D:\user\waveform"  
     'sets the default directory to D:\user\waveform.  
 "BB:ARB:WSEG:CONF:SEL 'multil'"  
     'creates the configuration file multil.inf\_mswv in default directory.  
 "BB:ARB:WSEG:CONF:OFIL 'mseg1\_2'"  
     'defines the file name mseg1\_2.wv for the multi-segment waveform file  
     created using configuration file multil.inf\_mswv.

*RST value	Resolution	Options	SCPI
-	-	B10/B11 and B13 SOURce2 only with second option B9/B10/B11	device-specific

**[SOURce<[1]2>:]BB:ARB:WSEgment:CONFigure:SEGMent:APPend <file\_name>**

This command appends the specified waveform to the configuration file.

This command triggers an event and therefore has no \*RST value and no query form.

**Example:**  
 "MMEM:CDIR 'D:\user\waveform"  
     'sets the default directory to D:\user\waveform.  
 "BB:ARB:WSEG:CONF:SEL 'new'"  
     'creates the configuration file new.inf\_mswv in the default directory.  
 "BB:ARB:WSEG:CONF:SEGM:APP 'arb1'"  
     'appends waveform arb1.wv to configuration file new. Waveform arb1 will be  
     the first segment of a multisegment waveform created with configuration file  
     new.

*RST value	Resolution	Options	SCPI
-	-	B10/B11 and B13 SOURce2 only with second option B9/B10/B11	device-specific

**[SOURce<[1]>:]BB:ARB:WSEgment:CONFigure:SEGMent:CATalog?**

This command queries the segments of the currently selected configuration file.

The command is a query command and therefore has no \*RST value.

**Example:** "MMEM:CDIR 'D:\user\waveform"  
 'sets the default directory to D:\user\waveform.  
 "BB:ARB:WSEG:CONF:SEL 'multi\_sin'"  
 'selects the configuration file multi\_sin.inf\_mswv.  
 "BB:ARB:WSEG:CONF:SEGM:CAT?"  
 'queries the segments of the selected configuration file.  
 Response: "arb4, arb2"  
 'The configuration file includes the segments 'arb4.wv' and 'arb2.wv'.

*RST value	Resolution	Options	SCPI
-	-	B10/B11 and B13 SOURce2 only with second option B9/B10/B11	device-specific

**[SOURce<[1]>:]BB:ARB:WSEgment:CONFigure:SElect <file\_name>**

The command selects the configuration file in the default directory A path can also be specified, in which case the files in the specified directory are selected. If a configuration file with the specified name does not yet exist, it is created. The file extension may be omitted. Only files with the file extension \*.inf\_mswv will be selected or created.

**Example:** "MMEM:CDIR 'D:\user\waveform"  
 'sets the default directory to D:\user\waveform.  
 "BB:ARB:WSEG:CONF:SEL 'new'"  
 'create configuration file new.inf\_mswv in the default directory.

*RST value	Resolution	Options	SCPI
-	-	B10/B11 and B13 SOURce2 only with second option B9/B10/B11	device-specific

**[SOURce<[1]>:]BB:ARB:WSEgment:CREate <file\_name>**

This command creates a multi-segment waveform using the current settings of the specified configuration file. The multi-segment waveform is saved into the file defined in the configuration file. The file extension is \*. **wv**.

This command triggers an event and therefore has no \*RST value and no query form.

**Example:**

```
"MMEM:CDIR 'D:\user\waveform"
  'sets the default directory to D:\user\waveform.

"BB:ARB:WSEG:CONF:SEL 'new'"
  'creates the configuration file new.inf_mswv in the default directory.

"BB:ARB:WSEG:CONF:SEGM:APP 'arb1'"
  'includes waveform sinus1.wv as segment 1 in the configuration file. The
  waveform must be available in the default directory.

"BB:ARB:WSEG:CONF:SEGM:APP 'arb2'"
  'includes waveform sinus1.wv as segment 1 in the configuration file. The
  waveform must be available in the default directory.

"BB:ARB:WSEG:CONF:OFIL 'multi_wv1'"
  'defines the file name multi_wv1.wv for the multi-segment waveform.

"BB:ARB:WSEG:CRE 'new'"
  'creates multi-segment waveform multi_wv1.wv using the settings of the
  configuration file new.inf_mswv.
```

*RST value	Resolution	Options	SCPI
-	-	B10/B11 and B13 SOURce2 only with second option B9/B10/B11	device-specific

**[SOURce<[1]>:]BB:ARB:WSEgment:NEXT 0 ... 2000**

This command selects the segment to be output.

**Example:**

```
"MMEM:CDIR 'D:\user\waveform"
  'sets the default directory to D:\user\waveform.

"BB:ARB:WSEG:NEXT 2"
  'selects segment 2 to be output.

"BB:ARB:TRIG:SMOD NEXT"
  'selects extended trigger mode next, i.e. the segment specified with command
  :BB:ARB:WSEG:NEXT will be output.

"BB:ARB:SEQ AUTO"
  'selects trigger mode Auto.

"BB:ARB:WAV:SEL 'multi_wv1'"
  'loads multi-segment waveform multi_wv1.wv. Generation of segment 2
  starts.

"BB:ARB:WSEG:NEXT 3"
  'switched at once to output of segment 3.
```

*RST value	Resolution	Options	SCPI
0	-	B10/B11 and B13 SOURce2 only with second option B9/B10/B11	device-specific

## R&S Vector Signal Generator Waveform and List Format

The R&S Vector Signal Generator uses a tag-oriented format for externally or internally generated waveforms as well as for data and control lists. The data can be transmitted via the IEC bus from an external computer to the R&S Vector Signal Generator and vice versa. For these purposes the file is transmitted as a binary data block, using IEC bus command `SOUR:BB:ARB:WAV:DATA`.

---

**Note:**

*A waveform version number is not necessary due to the flexible, tag-based form.*

---

Tags are self-contained information units. Their general format is:

**{Name: Data}** or **{Name-Length: Data}**

The colon separates the name part and the data part. The colon can be followed by a space for the sake of legibility.

The **Name** identifies the tag. It is always expressed in capital letters.

The **Data** is tag-specific, and in most cases it is in ASCII plain text.

The **Length** specifies the number of bytes in a WAVEFORM tag or DATA LIST tag (from ':' to '"', ASCII integer)

Each waveform file must begin with the TYPE tag. The sequence of the remaining tags is arbitrary. For each tag an indication shows whether it *must* be included in the file concerned (mandatory) or *may* be included (optional).

Unknown tags are not analyzed by the R&S Vector Signal Generator. On the other hand they are left unchanged, are saved without an error message and can be read back again.

AMIQ waveforms can also be loaded on the R&S Vector Signal Generator, where they are converted internally into an R&S Vector Signal Generator waveform.

The following sections first describe the mandatory TYPE tag which identifies the file and is always located at the start of the file. The rest of the tags used in the R&S Vector Signal Generator are then described in alphabetical order. Most tags are valid for all three file types. If a tag is valid only for a single file type, e.g. only for a waveform, this fact is indicated in the description.

**{TYPE: magic, xxxxxxxx} (mandatory, must be the first tag in the file)**

The *TYPE* tag identifies the file as a valid R&S Vector Signal Generator file. It must be present and must be the first in the waveform. If a file of the same name already exists on the target medium, it is overwritten.

**Note:**

*AMIQ waveforms can also be loaded on the R&S Vector Signal Generator, where they are converted internally into an R&S Vector Signal Generator waveform.*

**magic** 'magic' designates the file type and has the following values:

**SMATE-WV** The file contains a valid R&S Vector Signal Generator waveform.

**SMATE-DL** The file contains a valid R&S Vector Signal Generator data list.

**SMATE-CL** The file contains a valid R&S Vector Signal Generator control list.

**xxxxxxx:** 'xxxxxxx' is an ASCII-coded checksum of the data part of the WAVEFORM tag in the file. This value is always 0 for data lists and control lists.

The checksum for waveforms is used for detecting transmission errors. If the *TYPE* tag contains 0 or a non-numeric value for the checksum, it is ignored.

It is calculated in accordance with the following algorithm, where 'start' is a pointer to the first byte after the '#' character in the WAVEFORM tag and 'length' is the number of bytes between 'start' and the closing curly bracket (excluding the latter; 'length' must be divisible by 4 without a remainder):

```

UINT32 checksum(void *start, UINT32 length)
{
    UINT32 i, result = 0xA50F74FF;

    for(i=0; i < length/4; i++)
        result = result ^ ((UINT32 *)start)[i];

    return(result);
}

```

**Example:** {TYPE: SMATE-WV,106656}

**IEC bus query:** "BB:ARB:WAV:TAG? 'TYPE'"  
'queries the content of the 'TYPE' tag.

Response: "'SMATE-WV,106656'"  
'this is a valid waveform.'

**{CLOCK: frequency} (mandatory for waveforms)**

The tag specifies the clock frequency at which the waveform has to be output, in Hz. A query of `ARB:CLOCK?` after loading the waveform returns the value set using the `CLOCK` tag. This value can subsequently be altered with the aid of the `ARB:CLOCK` command.

**Example:** {CLOCK: 54000000}

**IEC bus query:** "BB:ARB:WAV:TAG? 'CLOCK'"  
'queries the content of the 'CLOCK' tag.

Response: "54000000"  
'the clock frequency is set to 54 MHz.

**{COMMENT: string} (optional)**

The tag contains a plain text ASCII string of arbitrary length. The string is not analyzed in the R&S Vector Signal Generator. It is used to describe the file. The string is allowed to contain all printable ASCII characters except the closing curly bracket.

**Example:** {COMMENT: File with data for 3GPP enhanced channels}

**IEC bus query:** "BB:ARB:WAV:TAG? 'COMMENT'"  
'queries the content of the 'COMMENT' tag of the selected waveform file.

Response: "File with data for 3GPP enhanced channels"  
'the comment on the waveform reads "File with data for 3GPP enhanced channels".

**{COPYRIGHT: string} (optional for waveforms)**

The tag contains an ASCII string of arbitrary length. The string is not analyzed in the R&S Vector Signal Generator. It is used to store copyright information about the file content.

**Example:** {COPYRIGHT: Rohde&Schwarz}

**IEC bus query:** "BB:ARB:WAV:TAG? 'COPYRIGHT'"  
'queries the content of the 'COPYRIGHT' tag of the selected waveform file.

Response: "'Rohde&Schwarz'"  
'copyright resides with Rohde&Schwarz.

**{DATA BITLENGTH: BitLength} (mandatory for data lists)**

The tag contains the length of the data held in the "DATA LIST" tag in bits in ASCII format.

**Example:** {DATA BITLENGTH: 444}

**IEC bus query:** "BB:DM:DLIS:TAG? 'DATA BITLENGTH'"  
'queries the content of the 'DATA BITLENGTH' tag of the selected data list file.

Response: "'444'"  
'the data list is 444 bits long.



**{DATA LIST-Length: #d<sub>0</sub>d<sub>1</sub>...d<sub>x</sub>...d<sub>N-1</sub>...}** (mandatory for data lists)

The tag contains the actual bit sequence of the data list in binary format.

**Length** 'Length' defines the number of bytes in the DATA LIST tag in ASCII Format (for format see WAVEFORM length).

**d<sub>x</sub>** Data bits in binary format (8-bit unsigned characters, MSB first).

**Example:** {DATA LIST-56: #011100001010101010010101010100.....001010}

**Example:** "BB:DM:DLIS:TAG? 'DATA LIST'"  
'queries the content of the 'DATA LIST' tag of the selected data list file.

Response: "56"

'transmits a data list which is 56 bytes long from ':' to '}'.

**{DATE: yyyy-mm-dd;hh:mm:ss}** (optional)

The tag contains the date and time at which the file was created. The year must be expressed as four digits. The R&S Vector Signal Generator does not analyze this tag.

**Example:** {DATE: 2003-04-02;14:32:12}

**IEC bus query:** "BB:ARB:WAV:TAG? 'DATE'"  
'queries the content of the 'DATE' tag of the selected waveform file.

Response: "'2003-04-02;14:32:12'"

'the waveform was created on April 2, 2003 at 14 hrs 32 min.

**{LEVEL OFFS: RMSOffset\_dB,PeakOffset\_dB}** (optional for waveforms)

The tag determines the level of the ARB signal in the waveform file. The offset levels define the offset of rms and peak value relative to the 16-bit full scale modulation (-32767 to + 32767) = 0 dB.

**RMSOffset\_dB** 'RMSOffset\_dB' defines the rms level offset of the signal relative to full scale ARB signal in the "WAVEFORM" tag. The offset is defined in ASCII float format. The value is always positive. A 3dB value indicates that the rms level of the signal is 3 dBs below the full scale (full scale = max. amplitude of vector of I/Q samples =  $|SIQ|_{max} = \sqrt{I^2+Q^2}_{max} = 0$  dB)

**PeakOffset\_dB** 'PeakOffset\_dB' defines the peak level offset of the signal relative to full scale for the ARB signal in the "WAVEFORM" tag. The offset is defined in ASCII float format. The value usually equals 0 dB as in the majority of cases the I/Q samples (signed 16-bit integer values) are modulated to full scale:

Full scale = 0 dB = max. amplitude of vector of I/Q samples =  $|SIQ|_{max} = \sqrt{I^2+Q^2}_{max} = (2^{15})-1 = 32767$ .

A positive PeakOffset\_dB value indicates that a headroom to full scale is provided when generating the waveform. A negative PeakOffset\_dB value indicates that overrange is likely for some samples, i.e. clipping might occur.

The crest factor can be calculated from the two values as follows:

crest factor =  $|PeakOffset\_dB - RMSOffset\_dB|$

**Example:** {LEVEL OFFS: 3.45,2}

**IEC bus query:** "BB:ARB:WAV:TAG? 'LEVEL OFFS'"  
'queries the content of the 'LEVEL OFFS' tag of the selected waveform file.

Response: "'3.45,2'"

'the level of the waveform is below full scale, clipping will not occur.

**{SAMPLES: Samples} (optional for waveforms)**

The tag contains the number of I/Q samples in the waveform in ASCII format.

**Example:** {SAMPLES: 4333}

**IEC bus query:** "BB:ARB:WAV:TAG? 'SAMPLES'"  
'queries the content of the 'SAMPLES' tag of the selected waveform file.

**Response:** "'4333'"  
'the waveform contains 4333 I/Q samples.'

**{[TRACE] LIST [#]: Pos<sub>0</sub>:Val<sub>0</sub>;Pos<sub>1</sub>:Val<sub>1</sub>;...Pos<sub>x</sub>:Val<sub>x</sub>;...Pos<sub>N-1</sub>:Val<sub>N-1</sub>}  
mandatory for control lists / optional for waveforms)**

The tag contains the data for the marker and control signals in the control list or the marker signals of ARB waveforms. To select which of these signals is defined, [TRACE] and the associated number are used. For ARB waveforms it is only meaningful to define marker signals.

**[TRACE]** [TRACE] specifies the name of the marker or control signal:  
You may choose from the following names:  
MARKER; BURST; LEVATT; CWMODE; HOP; MAP

**[#]** [#] specifies the number in the case of control signals and marker signals with the same name. There is a choice between 4 markers and 3 LEVATT signals. Lines LEVATT 1 and 2 are needed for internal purposes and should not be used.

**Pos** Pos specifies in ASCII format the number of the position in the sequence, with effect from which the binary state of the marker or of the control signal changes from 0 to 1 or from 1 to 0.

**Val** Val specifies the binary state of the marker or of the control signal{0; 1} from Pos<sub>x</sub> to Pos<sub>x+1</sub> exclusive in ASCII format.

**Example:** {MARKER LIST 1: 0:0;10:1;20:0;30:1}

**IEC bus query:** "BB:DM:CLIS:TAG? 'MARKER LIST 1'"  
'queries the content of the 'MARKER LIST 1' tag of the selected control list file.

**Response:** "'0:0;10:1;20:0;30:1'"  
'the marker setting for samples 0 to 9 = 0 (low), for 10 to 19 = 1 (high) and for 20 to 29 = 0. From sample 30 onward the marker setting = 1.'

**Example:** {LEVATT LIST 1: 0:0;10:1;20:0;30:1}

**IEC bus query:** "BB:DM:CLIS:TAG? 'LEVATT LIST 1'"  
'queries the content of the 'LEVATT LIST 1' tag of the selected control list file.

**Response:** "'0:0;10:1;20:0;30:1'"  
'level attenuation applies to data values 10 to 19 (high) and from data value 30 onward.'

**{WAVEFORM-Length: #I<sub>0</sub>Q<sub>0</sub>I<sub>1</sub>Q<sub>1</sub>...I<sub>x</sub>Q<sub>x</sub>...I<sub>N-1</sub>Q<sub>N-1</sub>...}** (mandatory for waveforms)

The tag contains the actual waveform data and consists of the following:

**Length** 'Length' specifies the number of bytes in a WAVEFORM tag and consists of the following:

- + Length of ", #" (1 byte)
- + Number of I/Q pairs \* 4 (2 bytes per I and per Q value).

I<sub>x</sub>Q<sub>x</sub>... represents binary data (16-bit signed integer in 2's complement notation) containing the I and Q component alternately and starting with the I component. Each component consists of two bytes, least significant byte (LSB) first.

The values of the two bytes in an I component and a Q component are in the range 0x0 to 0xFFFF (-32767 to +32767). This value is transferred to the D/A converter.

At 50 Ω between the inner and outer conductors of the I and Q outputs, an amplitude  $V_p$  of +/-0.5 Volt arises on the I/Q output connectors of the R&S Vector Signal Generator. When a PEP offset is defined (PEP OFFSET tag) the amplitude is correspondingly reduced.

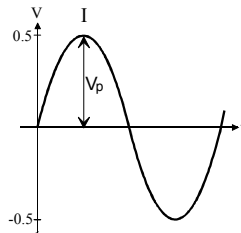

(The illustration also applies to the Q output)

**Example:** {WAVEFORM-401:#I,Q,I,Q,I,Q...I,Q} (100 I/Q pairs with 4 bytes each are transmitted)

**IEC bus query:** The data is transmitted using IEC bus command BB:ARB:WAVE:DATA.

## Creating a Waveform Manually

We will use the example of a sine function in the I channel and a cosine function in the Q channel, each with 20 points, to explain how a waveform file SICO.WV is generated.

The sine and cosine values are calculated by a short program written in the programming language C (see the following example for creating a C-program). They are stored in the file SICO.TXT as follows:

### Contents of SICO.TXT:

Sine (I)    Cosine (Q)

```
0.000000 1.000000
0.309017 0.951057
0.587785 0.809017
0.809017 0.587785
0.951057 0.309017
1.000000 -0.000000
0.951056 -0.309017
0.809017 -0.587785
0.587785 -0.809017
0.309017 -0.951056
-0.000000 -1.000000
-0.309017 -0.951057
-0.587785 -0.809017
-0.809017 -0.587785
-0.951056 -0.309017
-1.000000 0.000000
-0.951056 0.309017
-0.809017 0.587785
-0.587785 0.809017
-0.309017 0.951057
```

The decimal values in SICO.TXT should be normalized such that they are between -1.0 and +1.0.

The waveform file SICO.WV will be based on the contents of this file.

To be read by the R&S Vector Signal Generator these waveform data must be coded binary and packed into an appropriate WAVEFORM tag.

A tag consists of a name and a data set and is enclosed in curved brackets. The tag is a kind of label carrying information about what the R&S Vector Signal Generator should do with the data set (see above and step 3 of the following instructions).

The following steps outline how to create the waveform file SICO.WV:

### Step 1

The values from the file SICO.TXT must be converted into binary format consisting of integer numbers without a sign and with 16-bit width. The numeric range between  $-1.0$  and  $+1.0$  corresponds to the modulation range of the waveform D/A converter of 65535.

```
+1.0 →   32767   }
          0       } 2^16 = 65535
-1.0 →  -32767   }
```

A further C-program is suitable for creating the binary data set from the ASCII values stored in SICO.TXT file (see following example for creating a C-program). This program stores the binary data set to a file called SICO.WV.

The contents of the file SICO.WV reads as follows:

```
IQIQIQIQIQIQI ... IQ
```

**Explanation:** *There is no readable representation for binary values in this document. This is why we use the sequence IQIQIQ to characterize the binary code in the present example.*

### Step 2

The file SICO.WV now contains the binary data set corresponding to the 20 I/Q pairs. Before this binary data set can be further processed in step 3, the TYPE and the CLOCK tag

```
{TYPE: SMATE-WV, xxxxxxxx}
```

```
{CLOCK: yyy} must be placed in front.
```

**The TYPE tag must be the first entry in a WAVEFORM.** The TYPE tag identifies the waveform as a valid R&S Vector Signal Generator waveform.

**SMATE-WV** denotes that the waveform is self-contained.

**Xxxxxxx** is the checksum of the waveform. To simplify our example **0** is used, i.e., the R&S Vector Signal Generator does not evaluate a checksum.

**The TYPE tag** informs the R&S Vector Signal Generator about the clock rate of the waveform.

**yyy** is the clock frequency at which the waveform has to be output, in Hz

### Step 3

The binary data must now be packed into a WAVEFORM tag with the following structure:

```
{WAVEFORM-Length: □#IQIQIQIQIQIQIQIQIQI ... IQ}
```

The WAVEFORM tag consists of the following characters and data:

{	Opens each tag.
<b>WAVEFORM</b>	Name of the tag for waveform.
-	Separates the name from the length indication.
<b>Length</b>	Length of the data set <b>Length</b> indicates the number of bytes of the data set and consists of: + length of ",#" (1 byte) + number of I/Q pairs * 4 (2 bytes per I and per Q value).
	In our example containing a sine and a cosine with 20 pairs for each wave, the resulting length is <b>81</b> .
: □	Separates the name and length from the remainder of the data set. The blank □ can be omitted.
#	Indicates the beginning of the binary data.
<b>IQIQIQ</b>	Binary data set. The binary data contain the I and Q values in alternate order, the first value is an I value. Each value consists of 2 Bytes, starting with the least significant bit.
}	Terminates each tag.

The editor mentioned above which can handle binary data is now used to place the string "{WAVEFORM-81: #" in front and '}' at the end of the data set.

The contents of the waveform file SICO.WV for 20 I/Q pairs is now ready for operation and reads.

```
{TYPE: SMU-WV,0}
{CLOCK: 10e6}
{WAVEFORM-81: □# IQIQIQIQIQ ... IQ }
```

20 I/Q pairs = 80 bytes
81 bytes

The tags TYPE, CLOCK and WAVEFORM are mandatory for each waveform. All other tags are optional and can be inserted after the TYPE tag in arbitrary order, e.g.

```
{TYPE: SMATE-WV,0}
{COMMENT: I/Q=sine/cosine, 20 points, clock 10 MHz}
{CLOCK: 10e6}
{FILTER: 2,5MHz}
{WAVEFORM-81: #IQIQIQIQIQIQ ... IQ}
```

**C-program for creating the file SICO.TXT containing 20 sine and cosine pairs:**

```

#include <stdlib.h>
#include <stdio.h>
#include <math.h>

void main (void)
{
#define SAMPLES 20
int i;
float grad,rad;
FILE *logging_fp;

logging_fp = fopen("SICO.TXT", "w");

for (i = 0; i < SAMPLES; i++)
{
grad = (360.0 / (float)(SAMPLES)) * (float)i;
rad = grad * (3.141592654/180.0);
fprintf (logging_fp,"%f %f\n",sin(rad),cos(rad));
}
fclose(logging_fp);
}

```

Contents of the file  
SICO.TXT:

Sine (I)	Cosine (Q)
0.000000	1.000000
0.309017	0.951057
0.587785	0.809017
0.809017	0.587785
0.951057	0.309017
1.000000	-0.000000
0.951056	-0.309017
0.809017	-0.587785
0.587785	-0.809017
0.309017	-0.951056
-0.000000	-1.000000
-0.309017	-0.951057
-0.587785	-0.809017
-0.809017	-0.587785
-0.951056	-0.309017
-1.000000	0.000000
-0.951056	0.309017
-0.809017	0.587785
-0.587785	0.809017
-0.309017	0.951057

Extract from a C-program generating a binary data set from the I/Q pairs in the file SICO.TXT and storing the result to file SICO.WV:

```
:
FILE *fp_sour_i,*fp_sour_q,*fp_dest;
unsigned int i_uint, q_uint;
:
fp_sour = fopen("SICO.TXT", "rt" );
fp_dest = fopen("SICO.WV", "wb" );
:
while (1)
{
//Read I/Q pair from ASCII file
if (fscanf (fp_sour,"%f %f",&i_float, &q_float) == EOF)
break;

//Convert I/Q pair to unsigned integer
i_uint = (unsigned int) (i_float*32767.0)+0.5);
q_uint = (unsigned int) (q_float*32767.0)+0.5);

//Write converted I/Q pair to waveform file
fwrite (&i_uint,1,2,fp_dest);
fwrite (&q_uint,1,2,fp_dest);
}
:
```



## SOURce:BB:C2K-Subsystem

The commands in the Source:BB:C2K subsystem are described in three sections, separated into general remote commands, commands for base station settings and commands for mobile station settings.

This subsystem contains commands for the primary and general settings of the CDMA2000 standard. These settings concern activation and deactivation of the standard, setting the transmission direction, filter, clock, trigger and clipping settings, defining the chip rate and the sequence length, as well as the preset and power adjust setting.

The commands for setting the base station and the mobile station are described in separate sections. The commands are divided up in this way to make the extremely comprehensive SOURce:BB:C2K subsystem clearer.

The numerical suffix at SOURce distinguishes between path A and path B for two-path instruments:

SOURce<1> = path A

SOURce2 = path B

The keyword SOURce is optional with commands for path A and can be omitted. For path B, the command must include the keyword with the suffix 2.

Command	Parameter	Default Unit	Comments
[SOURce<[1] 2>:]BB:C2K:CLIPping:LEVel	1...100	PCT	
[SOURce<[1] 2>:]BB:C2K:CLIPping:MODE	VECTor   SCALar		
[SOURce<[1] 2>:]BB:C2K:CLIPping:STATe	ON   OFF		
[SOURce<[1] 2>:]BB:C2K:CLOCK:MODE	CHIP   MCHip		
[SOURce<[1] 2>:]BB:C2K:CLOCK:MULTIplier	1... 64		
[SOURce<[1] 2>:]BB:C2K:CLOCK:SOURce	EXTernal   INTernal		
[SOURce<[1] 2>:]BB:C2K:COPY:COFFset	0...255		
[SOURce<[1] 2>:]BB:C2K:COPY:DESTination	1...4		
[SOURce<[1] 2>:]BB:C2K:COPY:EXECute	-		
[SOURce<[1] 2>:]BB:C2K:COPY:SOURce	1...4		
[SOURce<[1] 2>:]BB:C2K:CRATe?			Query only
[SOURce<[1] 2>:]BB:C2K:CRATe:VARiation	1 MHz ... 5 MHz	Hz (c/s)	
[SOURce<[1] 2>:]BB:C2K:FILTer:PARAMeter:APCO25	0.15 ... 2.5		
[SOURce<[1] 2>:]BB:C2K:FILTer:PARAMeter:COSSine	0.05 ... 0.99		
[SOURce<[1] 2>:]BB:C2K:FILTer:PARAMeter:GAUSSs	0.15 ... 2.50		
[SOURce<[1] 2>:]BB:C2K:FILTer:PARAMeter:PGAus	0.15 ... 2.5		
[SOURce<[1] 2>:]BB:C2K:FILTer:PARAMeter:RCOSSine	0.05 ... 0.99		
[SOURce<[1] 2>:]BB:C2K:FILTer:PARAMeter:SPHase	0.15 ... 2.5		
[SOURce<[1] 2>:]BB:C2K:FILTer:TYPE	RCOSSine   COSSine   GAUSSs   LGAuss   PGAuss   CONE   COF705   COEQUALizer   COFEQUALizer   C2K3x   APCO25   SPHase   RECTangle		
[SOURce<[1] 2>:]BB:C2K:IQSWap:STATe	ON   OFF		

Command	Parameter	Default Unit	Comments
[SOURce<[1]>:]BB:C2K:LINK	FORWard   REVERSE (Alias DOWN   UP)		
[SOURce<[1]>:]BB:C2K:POWer:ADJusT	-		No query
[SOURce<[1]>:]BB:C2K:POWer[:TOTal]?			Query only
[SOURce<[1]>:]BB:C2K:PRESet			No query
[SOURce<[1]>:]BB:C2K:SEQuence	AUTO   RETRigger   AAUTO   ARETRigger   SINGLE		
[SOURce<[1]>:]BB:C2K:SETTing:CATalog?			Query only
[SOURce<[1]>:]BB:C2K:SETTing:DELeTe	<file_name>		
[SOURce<[1]>:]BB:C2K:SETTing:LOAD	<file_name>		
[SOURce<[1]>:]BB:C2K:SETTing:STORe	<file_name>		
[SOURce<[1]>:]BB:C2K:SLENgth	1 ... 511 frames		
[SOURce<[1]>:]BB:C2K:STATe	ON   OFF		
[SOURce<[1]>:]BB:C2K:TRIGger:ARM:EXECute			No query
[SOURce<[1]>:]BB:C2K:TRIGger:EXECute			No query
[SOURce<[1]>:]BB:C2K:TRIGger[:EXTernal<[1]>]:DELay	0 ...65 535 chips		
[SOURce<[1]>:]BB:C2K:TRIGger[:EXTernal<[1]>]:INHibit	0 ... (2 <sup>26</sup> - 1) chips		
[SOURce<[1]>:]BB:C2K:TRIGger:OBASeband:DELay	0 ...65 535 chips		
[SOURce<[1]>:]BB:C2K:TRIGger:OBASeband:INHibit	0 ... (2 <sup>26</sup> - 1) chips		
[SOURce<[1]>:]BB:C2K:TRIGger:OUTPut<[1]...4>:DELay	0 ... (2 <sup>24</sup> - 1) chips		
[SOURce<[1]>:]BB:C2K:TRIGger:OUTPut:DELay:FIXed	ON   OFF		
[SOURce<[1]>:]BB:C2K:TRIGger:OUTPut<[1]...4>:DELay:MAXimum?			Query only
[SOURce<[1]>:]BB:C2K:TRIGger:OUTPut<[1]...4>:DELay:MINimum?			Query only
[SOURce<[1]>:]BB:C2K:TRIGger:OUTPut<[1]...4>:MODE	PCGRoup   RFRame   SCFRame   SFRame   ESECond   CSPeriod   USER   RATio		
[SOURce<[1]>:]BB:C2K:TRIGger:OUTPut<[1]...4>:OFFTime	0 ... (2 <sup>24</sup> - 1) chips		
[SOURce<[1]>:]BB:C2K:TRIGger:OUTPut<[1]...4>:ONTime	0 ... (2 <sup>24</sup> - 1) chips		
[SOURce<[1]>:]BB:C2K:TRIGger:OUTPut<[1]...4>:PERiod	2 ... (2 <sup>32</sup> - 1) chips		
[SOURce<[1]>:]BB:C2K:TRIGger:RMODE			Query only
[SOURce<[1]>:]BB:C2K:TRIGger:SLENgth	0 ... (2 <sup>32</sup> - 1) chips		
[SOURce<[1]>:]BB:C2K:TRIGger:SLUNit	FRAMe   CHIP   SEQuence		
[SOURce<[1]>:]BB:C2K:TRIGger:SOURce	EXTernal   INTernal   BEXTernal   OBASeband		
[SOURce<[1]>:]BB:C2K:VERSion?			Query only
[SOURce<[1]>:]BB:C2K:WAVeform:CREate			No query

## SOURce:C2K - Primary Commands

### [SOURce<[1]>:]BB:C2K:CLIPping:LEVel 0 ... 100 PCT

The command sets the limit for level clipping (Clipping). This value indicates at what point the signal is clipped. It is specified as a percentage, relative to the highest level. 100% indicates that clipping does not take place.

Level clipping is activated with the command `SOUR:BB:C2K:CLIP:STAT ON`

**Example:** `"BB:C2K:CLIP:LEV 80PCT"`  
 'sets the limit for level clipping to 80% of the maximum level.

`"BB:C2K:CLIP:STAT ON"`  
 'activates level clipping.

*RST value	Resolution	Options	SCPI
100 PCT	1	B10/B11 and B13 K46 SOURce2 only with second option B9/B10/B11	Device-specific

### [SOURce<[1]>:]BB:C2K:CLIPping:MODE VECTor | SCALar

The command sets the method for level clipping (Clipping).

**Parameters:** **VECTor**  
 The reference level is the amplitude  $|i+jq|$ .

**SCALar**  
 The reference level is the absolute maximum of the I and Q values.

**Example:** `"BB:C2K:CLIP:MODE SCAL"`  
 'selects the absolute maximum of all the I and Q values as the reference level.

`"BB:C2K:CLIP:LEV 80PCT"`  
 'sets the limit for level clipping to 80% of this maximum level.

`"BB:C2K:CLIP:STAT ON"`  
 'activates level clipping.

*RST value	Resolution	Options	SCPI
VECTor	-	B10/B11 and B13 K46 SOURce2 only with second option B9/B10/B11	Device-specific

[SOURce<[1]|2>:]BB:C2K:CLIPping:STATe ON | OFF

The command activates level clipping (Clipping). The value is defined with the command [SOURce<[1]|2>:]BB:C2K:CLIPping:LEVel, the mode of calculation with the command [SOURce<[1]|2>:]BB:C2K:CLIPping:MODE.

**Example:** "BB:C2K:CLIP:STAT ON"  
'activates level clipping.

*RST value	Resolution	Options	SCPI
OFF		B10/B11 and B13 K46 SOURce2 only with second option B9/B10/B11	Device-specific

[SOURce<[1]|2>:]BB:C2K:CLOCK:MODE CHIP | MCHip

The command enters the type of externally supplied clock (:C2K:CLOCK:SOURce EXTernal). When MCHip is used, a multiple of the chip clock is supplied via the CLOCK connector and the chip clock is derived internally from this. The multiplier is entered with the command :BB:C2K:CLOCK:MULTIplier.

With this command the only numerical suffix allowed for SOURce is 1, since the external clock source is permanently allocated to path A.

**Example:** "BB:C2K:CLOC:MODE CHIP"  
'selects clock type **Chip**, i.e. the supplied clock is a chip clock.

*RST value	Resolution	Options	SCPI
CHIP	-	B10/B11 and B13 K46	Device-specific

[SOURce<[1]|2>:]BB:C2K:CLOCK:MULTIplier 1 ... 64

The command specifies the multiplier for clock type **Multipled** (:BB:C2K:CLOCK:MODE MCHip) in the case of an external clock source.

With this command the only numerical suffix allowed for SOURce is 1, since the external clock source is permanently allocated to path A.

**Example:** "BB:C2K:CLOC:SOUR EXT"  
'selects the external clock source. The clock is supplied via the CLOCK connector.

"BB:C2K:CLOC:MODE MCH"  
'selects clock type **Multipled**, i.e. the supplied clock has a rate which is a multiple of the chip rate.

"BB:C2K:CLOC:MULT 12"  
'the multiplier for the external clock rate is 12.

*RST value	Resolution	Options	SCPI
4	1	B10/B11 and B13 K46	Device-specific

[SOURce<[1]]2>:]BB:C2K:CLOCK:SOURce INTernal | EXTernal

The command selects the clock source.

Selecting EXTernal is only possible for path A, since the external clock source is permanently allocated to path A.

**Parameters:** INTernal

The internal clock reference is used.

**EXTernal**

The external clock reference is supplied to the CLOCK connector. Commands :BB:C2K:CLOCK:MODE and :MULTIplier are used to enter the type of the external clock.

**Example:**

:BB:C2K:CLOC:SOUR EXT"

'selects the external clock source. The clock is supplied via the CLOCK connector.

"BB:C2K:CLOC:MODE MCH"

'selects clock type **Multiplied**, i.e. the supplied clock has a rate which is a multiple of the chip rate.

"BB:C2K:CLOC:MULT 12"

'the multiplier for the external clock rate is 12.

*RST value	Resolution	Options	SCPI
INTernal	-	B10/B11 and B13 K46 SOURce2 only with second option B9/B10/B11	Device-specific

[SOURce<[1]]2>:]BB:C2K:COPY:COFFset 0 ... 255

The command sets the offset for the Walsh code in the destination base station. The minimum value is 0 (Walsh codes are identical), the maximum value is 255.

This command is only available in the downlink (SOUR:BB:C2K:LINK FORW/DOWN).

**Example:**

"BB:C2K:COPY:COFF 10"

'the Walsh code is shifted by 10 when the source base station is copied to the destination base station.

*RST value	Resolution	Options	SCPI
0	1	B10/B11 and B13 K46 SOURce2 only with second option B9/B10/B11	Device-specific

[SOURce<[1]|2>:]BB:C2K:COPY:DESTination 1...4

The command selects the station to which data is to be copied. Whether the data is copied to a base station or a mobile station depends on which transmission direction is selected (command C2K:LINK UP | DOWN).

**Example:** "BB:C2K:LINK DOWN"  
 'selects the downlink transmit direction (base station to mobile station).  
 "BB:C2K:COPY:SOUR 1"  
 'selects base station 1 as the source.  
 "BB:C2K:COPY:DEST 4"  
 'selects base station 4 as the destination.  
 "BB:C2K:COPY:EXEC"  
 'starts copying the parameter set of base station 1 to base station 4.

*RST value	Resolution	Options	SCPI
2	-	B10/B11 and B13 K46 SOURce2 only with second option B9/B10/B11	Device-specific

[SOURce<[1]|2>:]BB:C2K:COPY:EXECute

The command starts the copy process. The dataset of the source station is copied to the destination station. Whether the data is copied to a base station or a mobile station depends on which transmission direction is selected (command :BB:C2K:LINK UP | DOWN).

This command triggers an event and therefore has no \*RST value and no query form.

**Example:** "BB:C2K:COPY:EXEC"  
 'starts copying the parameter set of the selected source station to the selected destination station.

*RST value	Resolution	Options	SCPI
-	-	B10/B11 and B13 K46 SOURce2 only with second option B9/B10/B11	Device-specific

**[SOURce<[1]]2>:]BB:C2K:COPY:SOURce 1 ...4**

The command selects the station that has data to be copied. Whether the station copied is a base or mobile station depends on which transmission direction is selected (command C2K:LINK UP | DOWN).

- Example:** "BB:C2K:LINK UP"  
 'selects the uplink transmit direction (mobile station to base station).  
 "BB:C2K:COPY:SOUR 1"  
 'selects mobile station 1 as the source.  
 "BB:C2K:COPY:DEST 4"  
 'selects mobile station 4 as the destination.  
 "BB:C2K:COPY:EXEC"  
 'starts copying the parameter set of mobile station 1 to mobile station 4.

*RST value	Resolution	Options	SCPI
1	-	B10/B11 and B13 K46 SOURce2 only with second option B9/B10/B11	Device-specific

**[SOURce<[1]]2>:]BB:C2K:CRATe?**

The command queries the spreading rate. The output chip rate which determines the rate of the spread symbols as is used for signal output can be set with the command SOUR:BB:C2K:CRAT:VAR.

The command is a query command and therefore does not have an \*RST value.

- Example:** "BB:C2K:CRAT?"  
 'queries the system chip rate.  
 Response: "R1M2"  
 'the system chip rate is 1.2288 Mcps.

*RST value	Resolution	Options	SCPI
-	-	B10/B11 and B13 K46 SOURce2 only with second option B9/B10/B11	Device-specific

**[SOURce<[1]]2>:]BB:C2K:CRATe:VARiation 1 Mcps ... 5 Mcps**

The command enters the output chip rate.

The output chip rate changes the output clock and the modulation bandwidth, as well as the synchronization signals that are output. It does not affect the calculated chip sequence.

- Example:** "BB:C2K:CRAT:VAR 4086001"  
 "sets the chip rate to 4.08 Mcps.

*RST value	Resolution	Options	SCPI
1.2288	1 Hz	B10/B11 and B13 K46 SOURce2 only with second option B9/B10/B11	Device-specific

[SOURce<[1]>:]BB:C2K:FILTer:PARAmeter:APCO25 0.05 ... 0.99

The command sets the roll-off factor for filter type APCO25.

**Example:** "BB:C2K:FILT:PAR:APCO25 0.2"  
'sets the roll-off factor to 0.2 for filter type APCO25.

*RST value	Resolution	Options	SCPI
0.20	0.01	B10/B11 and B13 K46 SOURce2 only with second option B9/B10/B11	Device-specific

[SOURce<[1]>:]BB:C2K:FILTer:PARAmeter:COSSine 0.05 ... 0.99

The command sets the roll-off factor for the Cosine filter type.

**Example:** "BB:C2K:FILT:PAR:COS 0.35"  
'sets the roll-off factor to 0.35 for filter type Cosine.

*RST value	Resolution	Options	SCPI
0.35	0.01	B10/B11 and B13 K46 SOURce2 only with second option B9/B10/B11	Device-specific

[SOURce<[1]>:]BB:C2K:FILTer:PARAmeter:GAUSS 0.15 ... 2.5

The command sets the roll-off factor for the Gauss filter type.

**Example:** "BB:C2K:FILT:PAR:GAUS 0.5"  
'sets B x T to 0.5 for the Gauss filter type.

*RST value	Resolution	Options	SCPI
0.5	0.01	B10/B11 and B13 K46 SOURce2 only with second option B9/B10/B11	Device-specific

[SOURce<[1]>:]BB:C2K:FILTer:PARAmeter:PGAuss 0.15 ... 2.5

The command sets the roll-off factor for the Pure Gauss filter type.

**Example:** "BB:C2K:FILT:PAR:GAUS 0.5"  
'sets B x T to 0.5 for the Pure Gauss filter type.

*RST value	Resolution	Options	SCPI
0.5	0.01	B10/B11 and B13 K46 SOURce2 only with second option B9/B10/B11	Device-specific



[SOURce<[1]|2>:]BB:C2K:FILTer:PARameter:RCOSine 0.05 ... 0.99

The command sets the roll-off factor for the Root Cosine filter type.

**Example:** "BB:C2K:FILT:PAR:RCOS 0.22"  
 'sets the roll-off factor to 0.22 for filter type Root Cosine.

*RST value	Resolution	Options	SCPI
0.22	0.01	B10/B11 and B13 K46 SOURce2 only with second option B9/B10/B11	Device-specific

[SOURce<[1]|2>:]BB:C2K:FILTer:PARameter:SPHase 0.15 ... 2.5

The command sets B x T for the Split Phase filter type.

**Example:** "BB:C2K:FILT:PAR:SPH 0.5"  
 'sets B x T to 0.5 for the Split Phase filter type.

*RST value	Resolution	Options	SCPI
2.00	0.01	B10/B11 and B13 K46 SOURce2 only with second option B9/B10/B11	Device-specific

[SOURce<[1]|2>:]BB:C2K:FILTer:TYPE RCOSine | COSine | GAUSs | LGAuss | PGAuss | CONE | COF705 | COEqualizer | COFequalizer | C2K3x | APCO25 | SPHase | RECTangle

The command selects the filter type. The filter types are described in Chapter 4, Section "[Baseband Filter - Custom Digital Mod](#)".

**Example:** "BB:C2K:FILT:TYPE CONE"  
 'sets the filter type CdmaOne. This filter type is defined by the standard for the uplink.

*RST value	Resolution	Options	SCPI
Downlink:COEF Uplink: CONE	-	B10/B11 and B13 K46 SOURce2 only with second option B9/B10/B11	Device-specific

[SOURce<[1]]2>:]BB:C2K:IQSWap:STATe ON | OFF

This command inverts the Q-part of the baseband signal if set to ON. The signal on the baseband outputs meets the cdma2000 standard. In order to generate an RF signal that conforms to the standard, the **I/Q Swap** function in the **I/Q Modulator** menu must be enabled (**On**)

(SOURce:IQ:SWAP ON).

**Example:** "BB:C2K:IQSW:STAT ON"  
'inverts the Q-part of the baseband signal.

*RST value	Resolution	Options	SCPI
OFF	-	B10/B11 and B13 K46 SOURce2 only with second option B9/B10/B11	Device-specific

[SOURce<[1]]2>:]BB:C2K:LINK FORWard|DOWN | REVerse|UP

The command defines the transmission direction. The signal either corresponds to that of a base station (FORWard | DOWN) or that of a mobile station (REVerse | UP).

**Example:** "BB:C2K:LINK DOWN"  
'the transmission direction selected is base station to mobile station. The signal corresponds to that of a base station.

*RST value	Resolution	Options	SCPI
FORWard DOWN	-	B10/B11 and B13 K46 SOURce2 only with second option B9/B10/B11	Device-specific

[SOURce<[1]]2>:]BB:C2K:POWer[:TOTAl]?

The command queries the total power of the active channels. After **Power Adjust**, this power corresponds to 0 dB.

The command is a query command and therefore does not have an \*RST value.

**Example:** "BB:C2K:POW?"  
'queries the total power of the active channels.

Response: "-22.5"  
'the total power is -25 dB.

*RST value	Resolution	Options	SCPI
-	-	B10/B11 and B13 K46 SOURce2 only with second option B9/B10/B11	Device-specific

**[SOURce<[1]>:]BB:C2K:POWer:ADJust**

The command sets the power of the active channels in such a way that the total power of the active channels is 0 dB. This will not change the power ratio among the individual channels.

The command triggers an action and therefore has no \*RST value and no query form.

**Example:** "BB:C2K:POW:ADJ"  
 'the total power of the active channels is set to 0 dB, the power ratio among the individual channels is unchanged.

*RST value	Resolution	Options	SCPI
-	-	B10/B11 and B13 K46 SOURce2 only with second option B9/B10/B11	Device-specific

**[SOURce<[1]>:]BB:C2K:PRESet**

The command produces a standardized default for the CDMA2000 standard. The settings correspond to the \*RST values specified for the commands.

This command triggers an action and therefore has no \*RST value and no query form.

**Example:** "BB:C2K:PREs"  
 'resets all the CDMA2000 settings to default values.

*RST value	Resolution	Options	Options	SCPI
-	-	B10/B11 and B13 K46 SOURce2 only with second option B9/B10/B11	All CDMA2000 settings are preset. An overview is provided by Table in Chapter 4.	Device-specific

[SOURce<[1]|2>:]BB:C2K:SEQuence AUTO | RETRigger | AAUTo | ARETrigger | SINGle

The command selects the trigger mode.

**Parameters:**     **AUTO**  
                           The modulation signal is generated continuously.

**RETRigger**  
                           The modulation signal is generated continuously. A trigger event (internal or external) causes a restart.

**AAUTo**  
                           The modulation signal is generated only when a trigger event occurs. After the trigger event the signal is generated continuously. Signal generation is stopped with command SOUR:BB:C2K:TRIG:ARM:EXEC and started again when a trigger event occurs.

**ARETrigger**  
                           The modulation signal is generated only when a trigger event occurs. The device automatically toggles to RETRIG mode. Every subsequent trigger event causes a restart.  
                           Signal generation is stopped with command SOUR:BB:C2K:TRIG:ARM:EXEC and started again when a trigger event occurs.

**SINGle**  
                           The modulation signal is generated only when a trigger) event occurs. After the trigger event the signal is generated once to the set sequence length (SOUR:BB:C2K:TRIG:SLEN). Every subsequent trigger event causes a restart.

**Example:**           "BB:C2K:SEQ AAUT"  
                           'sets the **Armed\_auto** trigger mode; the device waits for the first trigger (e.g. with \*TRG) and then generates the signal continuously.

*RST value	Resolution	Options	SCPI
AUTO	-	B10/B11 and B13 K46 SOURce2 only with second option B9/B10/B11	Device-specific

[SOURce<[1]|2>:]BB:C2K:SETTing:CATalog?

This command reads out the files with CDMA2000 settings in the default directory. The default directory is set using command MMEM:CDIRectory. A path can also be specified, in which case the files in the specified directory are read. Only files with the file extension \*.cdma2k will be listed.

The command is a query command and therefore has no \*RST value.

**Example:**           "MMEM:CDIR 'D:\user\cdma"  
                           'sets the default directory to D:\user\cdma.  
                           "BB:C2K:SETT:CAT?"  
                           'reads out all the files with CDMA2000 settings in the default directory.  
                           Response: "'CDMA\_UP', 'CDMA\_DN'"  
                           'the files 'CDMA\_UP' and 'CDMA\_DN' are available.

*RST value	Resolution	Options	SCPI
-	-	B10/B11 and B13 K46 SOURce2 only with second option B9/B10/B11	Device-specific

**[SOURce<[1]>:]BB:C2K:SETTing:DELete <file\_name>**

This command deletes the selected file with CDMA2000 settings. The directory is set using command `M MEM:CDIRectory`. A path can also be specified, in which case the files in the specified directory are read. The file extension may be omitted. Only files with the file extension `*.cdma2k` will be deleted.

This command triggers an event and therefore has no `*RST` value and no query form.

**Example:** `"BB:C2K:SETT:DEL 'CDMA_UP'"`  
 'deletes file 'CDMA\_UP'.

*RST value	Resolution	Options	SCPI
-	-	B10/B11 and B13 K46 SOURce2 only with second option B9/B10/B11	Device-specific

**[SOURce<[1]>:]BB:C2K:SETTing:LOAD <file\_name>**

This command loads the selected file with CDMA2000 settings. The directory is set using command `M MEM:CDIRectory`. A path can also be specified, in which case the files in the specified directory are read. The file extension may be omitted. Only files with the file extension `*.cdma2k` will be loaded.

This command triggers an event and therefore has no `*RST` value and no query form.

**Example:** `"BB:C2K:SETT:LOAD 'CDMA_UP'"`  
 'loads file 'CDMA\_UP'.

*RST value	Resolution	Options	SCPI
-	-	B10/B11 and B13 K46 SOURce2 only with second option B9/B10/B11	Device-specific

**[SOURce<[1]>:]BB:C2K:SETTing:STORe <file\_name>**

This command stores the current CDMA2000 settings into the selected file. The directory is set using command `M MEM:CDIRectory`. A path can also be specified, in which case the files in the specified directory are read. Only the file name has to be entered. CDMA2000 settings are stored as files with the specific file extensions `*.cdma2k`.

This command triggers an event and therefore has no `*RST` value and no query form.

**Example:** `"BB:C2K:SETT:STOR 'CDMA_UP'"`  
 'stores the current CDMA2000 settings into file 'CDMA\_UP'.

*RST value	Resolution	Options	SCPI
-	-	B10/B11 and B13 K46 SOURce2 only with second option B9/B10/B11	Device-specific

[SOURce<[1]|2>:]BB:C2K:SLENgth 1 ... 511 frames

The command sets the sequence length of the arbitrary waveform component of the CDMA2000 signal in the number of frames. This component is calculated in advance and output in the arbitrary waveform generator. It is added to the realtime signal components.

**Example:** "BB:C2K:SLEN 10"  
'sets the sequence length to 10 frames.

*RST value	Resolution	Options	SCPI
1	-	B10/B11 and B13 K46 SOURce2 only with second option B9/B10/B11	Device-specific

[SOURce<[1]|2>:]BB:C2K:STATe ON | OFF

The command activates modulation in accordance with the CDMA2000 standard. Activating this standard deactivates all the other digital standards and digital modulation modes on the same path.

**Example:** "BB:C2K:STAT ON"  
'activates modulation in accordance with the CDMA2000 standard.

*RST value	Resolution	Options	Dependenciesen	SCPI
OFF	-	B10/B11 and B13 K46 SOURce2 only with second option B9/B10/B11	BB:C2K:STAT ON deactivates the other standards and digital modulation.	Device-specific

[SOURce<[1]|2>:]BB:C2K:TRIGger:ARM:EXECute

The command stops signal generation for trigger modes Armed\_Auto and Armed\_Retrigger. A subsequent internal or external trigger event restart signal generation.

This command triggers an event and therefore has no \*RST value and no query form.

**Example:** "BB:C2K:TRIG:SOUR INT"  
'sets internal triggering.

"BB:C2K:TRIG:SEQ ARET"  
'sets Armed\_Retrigger mode, i.e. every trigger event causes signal generation to restart.

"BB:C2K:TRIG:EXEC"  
'executes a trigger, signal generation is started.

"BB:C2K:TRIG:ARM:EXEC"  
'signal generation is stopped.

"BB:C2K:TRIG:EXEC"  
'executes a trigger, signal generation is started again.

*RST value	Resolution	Options	SCPI
		B10/B11 and B13 K46 SOURce2 only with second option B9/B10/B11	Device-specific

**[SOURce<[1]|2>:]BB:C2K:TRIGger:EXECute**

The command executes a trigger. The internal trigger source must be selected using the command :BB:C2K:TRIG:SOUR INT and a trigger mode other than AUTO must be selected using the command :BB:C2K:TRIG:SEQ.

This command triggers an event and therefore has no \*RST value and no query form.

**Example:** "BB:C2K:TRIG:SOUR INT"  
 'sets internal triggering.  
 "BB:C2K:TRIG:SEQ RETR"  
 'sets Retrigger mode, i.e. every trigger event causes signal generation to restart.  
 "BB:C2K:TRIG:EXEC"  
 'executes a trigger.

*RST value	Resolution	Options	SCPI
		B10/B11 and B13 K46 SOURce2 only with second option B9/B10/B11	Device-specific

**[SOURce<[1]|2>:]BB:C2K:TRIGger[:EXTErnal<[1]|2>]:DELay 0 ... 65 535 chips**

The command specifies the trigger delay (expressed as a number of chips)for external triggering. The numeric suffix to EXTErnal distinguishes between the external trigger via the TRIGGER 1 (suffix 1) and TRIGGER 2 (suffix 2) connector.

**Example:** "BB:C2K:TRIG:SOUR EXT"  
 'sets an external trigger via the TRIGGER 1 connector.  
 "BB:C2K:TRIG:DEL 50"  
 'sets a delay of 50 symbols for the trigger.

*RST value	Resolution	Options	SCPI
0 chips	1 chip	B10/B11 and B13 K46 SOURce2 only with second option B9/B10/B11	Device-specific

**[SOURce<[1]|2>:]BB:C2K:TRIGger[:EXTernal<[1]|2>]:INHibit 0 ...67 108 863 chips**

The command specifies the number of chips by which a restart is to be inhibited following a trigger event. This command applies only in the case of external triggering. The numeric suffix to EXTernal distinguishes between the external trigger via the TRIGGER 1 (suffix 1) and TRIGGER 2 (suffix 2) connector.

**Example:** "BB:C2K:TRIG:SOUR EXT"  
 'selects an external trigger via the TRIGGER 1 connector.  
 "BB:C2K:TRIG:INH 200"  
 'sets a restart inhibit for 200 chips following a trigger event.

*RST value	Resolution	Options	SCPI
0 chips	1 chip	B10/B11 and B13 K46 SOURce2 only with second option B9/B10/B11	Device-specific

**SOURce<[1]|2>:]BB:C2K:TRIGger:OBASband:DELay 0 ... 65 535 chips**

The command specifies the trigger delay (expressed as a number of chips) for triggering by the trigger signal from the second path (two-path instruments only).

**Example:** "BB:C2K:TRIG:SOUR OBAS"  
 'sets for path A the internal trigger executed by the trigger signal from the second path (path B).  
 "BB:C2K:TRIG:OBAS:DEL 50"  
 'sets a delay of 50 symbols for the trigger.

*RST value	Resolution	Options	SCPI
0 chips	1 chip	B10/B11 and two options B13 K46	Device-specific

**SOURce<[1]|2>:]BB:C2K:TRIGger:OBASband:INHibit 0 ..67 108 863 chips**

The command specifies the number of chips by which a restart is to be inhibited following a trigger event. This command applies only for triggering by the second path (two-path instruments only).

**Example:** "BB:C2K:TRIG:SOUR OBAS"  
 'sets for path A the internal trigger executed by the trigger signal from the second path (path B).  
 "BB:C2K:TRIG:INH 200"  
 'sets a restart inhibit for 200 chips following a trigger event.

*RST value	Resolution	Options	SCPI
0 chips	1 chip	B10/B11 and two options B13 K46	Device-specific



**[SOURce<[1]>:]BB:C2K:TRIGger:OUTPut<[1]...4>:DELay 0 .. (2^24 - 1) chips**

The command defines the delay between the signal on the marker outputs and the start of the signal, expressed in terms of chips. Command :BB:C2K:TRIGger:OUTPut:DELay:FIXed can be used to restrict the range of values to the dynamic range, i.e. the range within which a delay of the marker signals can be set without restarting the marker and signal.

**Example:** "BB:C2K:TRIG:OUTP2:DEL 16000"  
'sets a delay of 16000 chips for the signal on connector MARKER 2.

*RST value	Resolution	Options	SCPI
0	1 Chip	B10/B11 and B13 K46 SOURce2 only with second option B9/B10/B11	Device-specific

**[SOURce<[1]>:]BB:C2K:TRIGger:OUTPut:DELay:FIXed ON | OFF**

The command restricts the marker delay setting range to the dynamic range. In this range the delay can be set without restarting the marker and signal. If a delay is entered in setting ON but is outside this range, the maximum possible delay is set and an error message is generated.

The numeric suffix in OUTPut has no significance for this command, since the setting always affects every marker.

**Example:** "BB:C2K:TRIG:OUTP:DEL:FIX ON"  
'restricts the marker signal delay setting range to the dynamic range.

*RST value	Resolution	Options	SCPI
OFF	-	B10/B11 and B13 K46 SOURce2 only with second option B9/B10/B11	Device-specific

**[SOURce<[1]>:]BB:C2K:TRIGger:OUTPut<[1]...4>:DELay:MAXimum?**

The command queries the maximum marker delay for setting :BB:C2K:TRIG:OUTP:DEL:FIX ON.

The command is a query only and therefore has no \*RST value.

**Example:** "BB:C2K:TRIG:OUTP:DEL:FIX ON"  
'restricts the marker signal delay setting range to the dynamic range.

"BB:C2K:TRIG:OUTP:DEL:MAX"  
'queries the maximum of the dynamic range.

Response: "20000"  
'the maximum for the marker delay setting is 20000 chips.

*RST value	Resolution	Options	SCPI
-	-	B10/B11 and B13 K46 SOURce2 only with second option B9/B10/B11	Device-specific

**[SOURce<[1]|2>:]BB:C2K:TRIGger:OUTPut<[1]...4>:DELay:MINimum?**

The command queries the minimum marker delay for setting :BB:C2K:TRIGger:OUTPut:DELay:FIXed ON.

The command is a query only and therefore has no \*RST value.

**Example:** "BB:C2K:TRIG:OUTP:DEL:FIX ON"  
 'restricts the marker signal delay setting range to the dynamic range.

"BB:C2K:TRIG:OUTP:DEL:MIN"  
 'queries the minimum of the dynamic range.

Response: "0"  
 'the minimum for the marker delay setting is 0 symbols.

*RST value	Resolution	Options	SCPI
-	-	B10/B11 and B13 K46 SOURce2 only with second option B9/B10/B11	Device-specific

[SOURce<[1]|2>:]BB:C2K:TRIGger:OUTPut<[1]...4>:MODE PCGRoup | RFRame | SCFRame | SFRame | ESECond | CSPeriod | USER | RATio

The command defines the signal for the selected marker output

- Parameters:**
  - PCGRoup**  
A marker signal is generated at the start of each power control group (every 1.25 ms).
  - RFRame**  
A marker signal is generated every 20 ms (traffic channel clock).
  - SCFRame**  
A marker signal is generated at the start of each sync channel frame (every 26,6 ms).
  - SFRame**  
A marker signal is generated every 80 ms (super frame clock).
  - ESECond**  
A marker signal is generated every 2 s (even second mark).
  - CSPeriod**  
A marker signal is generated at the start of each arbitrary waveform sequence (depending on the set sequence length). The marker signal is also generated if the signal contains no ARB.
  - RATio**  
A regular marker signal corresponding to the Time Off / Time On specifications in the commands  
SOURce:BB:C2K:TRIGger:OUTPut:OFFTime and  
SOURce:BB:C2K:TRIGger:OUTPut:ONTime is generated.
  - USER**  
A marker signal is generated at the beginning of every user-defined period.  
The period is defined with command SOUR:BB:C2K:TRIG:OUTP:PERiod

**Example:** "BB:C2K:TRIG:OUTP2:MODE RFR"  
'selects the traffic channel clock on output MARKER 2.

*RST value	Resolution	Options	SCPI
RFRame	-	B10/B11 and B13 K46 SOURce2 only with second option B9/B10/B11	Device-specific

[SOURce<[1]|2>:]BB:C2K:TRIGger:OUTPut<[1]...4>:OFFTime 1 ... 2^24 - 1 (16 777 215) chips

The command sets the number of chips in a period (ON time + OFF time) during which the marker signal in setting SOURce:BB:C2K:TRIGger:OUTPut:MODE RATio on the marker outputs is OFF.

**Example:** "BB:C2K:TRIG:OUTP2:OFFT 2000"  
'sets an OFF time of 2000 chips for marker signal 2 on path A.

*RST value	Resolution	Options	SCPI
1 chip	1	B10/B11 and B13 K46 SOURce2 only with second option B9/B10/B11	Device-specific

**[SOURce<[1]|2>:]BB:C2K:TRIGger:OUTPut<[1]...4>:ONTime 1 ... 2<sup>24</sup> - 1 (16 777 215) chips**

The command sets the number of chip in a period (ON time + OFF time) during which the marker signal in setting SOURce:BB:C2K:TRIGger:OUTPut:MODE RATIo on the marker outputs is ON.

**Example:** "BB:C2K:TRIG:OUTP2:ONT 2000"  
'sets an ON time of 2000 chips for marker 2 on path A.

*RST value	Resolution	Options	SCPI
1 chip	1	B10/B11 and B13 K46 SOURce2 only with second option B9/B10/B11	Device-specific

**[SOURce<[1]|2>:]BB:C2K:TRIGger:OUTPut<[1]...4>:PERiod 2 ... (2<sup>32</sup>-1) chips**

The command sets the repetition rate for the signal at the marker outputs, expressed in terms of chips. The setting is only valid for selection USER in :BB:C2K:TRIG:OUTP:MODE.

**Example:** "BB:C2K:TRIG:OUTP2:MODE USER"  
'selects the user marker for the signal on connector MARKER 2.  
"BB:C2K:TRIG:OUTP2:PER 1600"  
'sets a period of 1600 chips, i.e. the marker signal is repeated every 1600th chip.

*RST value	Resolution	Options	SCPI
1 Frame (38400 chips)	1 chip	B10/B11 and B13 K46 SOURce2 only with second option B9/B10/B11	Device-specific

**[SOURce<[1]>:]BB:C2K:TRIGger:RMODE**

The command queries the current status of signal generation for all trigger modes with CDMA2000 modulation on.

The command is a query command and therefore has no \*RST value.

**Parameter: RUN**

the signal is generated. A trigger event occurred in the triggered mode.

**STOP**

the signal is not generated. A trigger event did not occur in the triggered modes, or signal generation was stopped by the command

:BB:C2K:TRIG:ARM:EXECute (armed trigger modes only).

**Example:**

"SOUR2:BB:C2K:TRIG:SOUR EXT"

'sets external triggering via the TRIGGER 1 connector for path B of a two-path instrument.

"BB:C2K:TRIG:MODE ARET"

'selects the Armed\_Retrigger mode.

"BB:C2K:TRIG:RMODE?"

'queries the current status of signal generation.

Response: "RUN"

'the signal is generated, an external trigger was executed.

*RST value	Resolution	Options	SCPI
-	-	B10/B11 and B13 K46 SOURce2 only with second option B9/B10/B11	Device-specific

**[SOURce<[1]>:]BB:C2K:TRIGger:SLENGth 1 ... 2<sup>32</sup>-1 (4 294 967 295) chips**

The command defines the length of the signal sequence to be output in the **Single** trigger mode (SOUR:BB:C2K:SEQ SING). The unit is defined with command SOUR:BB:C2K:TRIG:SLUNit. It is then possible to output deliberately just part of the frame, an exact sequence of the frame, or a defined number of repetitions of the frame.

**Example:**

"SOUR2:BB:C2K:SEQ SING"

'sets trigger mode Single.

"SOUR2:BB:C2K:TRIG:SLUN CHIP"

'sets unit chips for the entry of sequence length.

"SOUR2:BB:C2K:TRIG:SLEN 200"

'sets a sequence length of 200 chips. The first 200 chips of the current frame will be output after the next trigger event.

*RST value	Resolution	Options	SCPI
1 frame length	-	B10/B11 and B13 K46 SOURce2 only with second option B9/B10/B11	Device-specific

[SOURce<[1]|2>:]BB:C2K:TRIGger:SLUNit FRAMe | CHIP | SEQuence

The command defines the unit for the entry of the length of the signal sequence (SOUR:BB:C2K:TRIG:SLEN) to be output in the **Single** trigger mode (SOUR:BB:C2K:SEQ SING).

**Example:** "SOUR2:BB:C2K:SEQ SING"  
 'sets trigger mode Single.

"SOUR2:BB:C2K:TRIG:SLUN FRAM"  
 'sets unit frames for the entry of sequence length.

"SOUR2:BB:C2K:TRIG:SLEN 2"  
 'sets a sequence length of 2 frames. The current frame will be output twice after the next trigger event.

*RST value	Resolution	Options	SCPI
SEQuence	-	B10/B11 and B13 K46 SOURce2 only with second option B9/B10/B11	Device-specific

[SOURce<[1]|2>:]BB:C2K:TRIGger:SOURce INTernal | EXTernal | BEXTernal | OBASeband

The command selects the trigger source.

**Parameter: INTernal**  
 Triggering is executed by means of the Trigger command SOURce<[1]|2>:BB:C2K:TRIGger:EXECute or \*TRG in the case of remote control and by means of **Execute Trigger** in the case of manual operation.

**EXTernal**  
 Triggering is executed by means of the signal on the TRIGGER 1 connector.

**BEXTernal**  
 Triggering is executed by means of the signal on the TRIGGER 2 connector.

**OBASeband**  
 Triggering is executed by means of the trigger signal from the second path (two-path instruments only).

**Example:** "SOUR2:BB:C2K:TRIG:SOUR EXT"  
 'sets external triggering via the TRIGGER 1 connector for path B of a two-path instrument.

*RST value	Resolution	Options	SCPI
INTernal	-	B10/B11 and B13 K46 SOURce2 only with second option B9/B10/B11	Device-specific

[SOURce<[1]|2>:]BB:C2K:VERSion?

The command queries the version of the CDMA standard underlying the definitions.

The command is a query command and therefore does not have an \*RST value. The numerical suffix at SOURce has no significance for this command and should not be specified.

**Example:** "BB:C2K:VERS?"  
'queries the CDMA version.

Response: "Release C"  
'CDMA Release 5

*RST value	Resolution	Options	SCPI
-	-	B10/B11 and B13 K46	Device-specific

[SOURce<[1]|2>:]BB:C2K:WAVeform:CREate <file\_name>

This command creates a waveform using the current settings of the **CDMA2000** menu. The file name is entered with the command. The file is stored with the predefined file extension \*.wv. The file name and the directory it is stored in are user-definable..

This command triggers an event and therefore has no \*RST value and no query form.

**Example:** "MMEM:CDIR 'D:\user\waveform"  
'sets the default directory to D:\user\waveform.  
"BB:C2K:WAV:CRE 'cdma\_bs'"  
'creates the waveform file cdma\_bs.wv in the default directory.

*RST value	Resolution	Options	SCPI
-	-	B10/B11 and B13 K46 SOURce2 only with second option B9/B10/B11	device-specific

## SOURce:BB:C2K - Predefined Settings

The R&S Vector Signal Generator gives you the opportunity to generate predefined test settings for base station 1: These predefined settings enable the creation of highly complex scenarios for the downlink by presetting the channel table of base station 1. The settings take effect only after execution of command [SOURce<[1]|2>:]BB:C2K:PPARameter:EXECute.

Command	Parameter	Default Unit	Comments
[SOURce<[1] 2>:]BB:C2K:PPARameter:CRESt	MINimum   AVERAge   WORSt		
[SOURce<[1] 2>:]BB:C2K:PPARameter:EXECute			No query
[SOURce<[1] 2>:]BB:C2K:PPARameter:PCHannel[:STATe]	ON   OFF		
[SOURce<[1] 2>:]BB:C2K:PPARameter:PICHannel[:STATe]	ON   OFF		
[SOURce<[1] 2>:]BB:C2K:PPARameter:RCONfiguration	1 ... 5		
[SOURce<[1] 2>:]BB:C2K:PPARameter:SCHannels[:STATe]	ON   OFF		
[SOURce<[1] 2>:]BB:C2K:PPARameter:TCHannel:COUNT	0 ... 8		
[SOURce<[1] 2>:]BB:C2K:PPARameter:TCHannel:DATA:RATE	DR1K2   DR1K3   DR1K5   DR1K8   DR2K4   DR2K7   DR3K6   DR4K8   DR7K2   DR9K6   DR14K4   DR19K2   DR28K8   DR38K4   DR57K6   DR76K8   DR115K2   DR153K6   DR230K4   DR259K2   DR307K2   DR460K8   DR518K4   DR614K4   DR1036K8   NUSed		
[SOURce<[1] 2>:]BB:C2K:PPARameter:TCHannel:DCCHannel[:STATe]	ON   OFF		
[SOURce<[1] 2>:]BB:C2K:PPARameter:TCHannel:FCHannel[:STATe]	ON   OFF		
[SOURce<[1] 2>:]BB:C2K:PPARameter:TCHannel:FLENgth	20 ms   40 ms   80 ms	s	
[SOURce<[1] 2>:]BB:C2K:PPARameter:TCHannel:SCHannel:COUNT	1 ... 7		



[SOURce<[1]>:]BB:C2K:PPARAmeter:CRESt MINimum | AVERAge | WORSt

This commands selects the desired range for the crest factor of the test scenario. The crest factor of the signal is kept in the desired range by automatically setting appropriate Walsh codes and timing offsets.

The setting takes effect only after execution of command :SOURce:BB:C2K:PPARAmeter:EXEC.

- Parameter:**
  - MINimum**  
The crest factor is minimized. The Walsh codes are spaced as closely as possible.
  - AVERAge**  
An average crest factor is set. The Walsh codes are distributed uniformly over the code domain.
  - WORSt**  
The crest factor is set to an unfavorable value (i.e. maximum). The Walsh codes are as wildly spaced as possible.

**Example:** "BB:C2K:PPAR:CRESt WORSt"  
'sets the crest factor to an unfavorable value.

*RST value	Options	Dependencies	SCPI
MINimum	B10/B11 and B13 K46 SOURce2 only with second option B9/B10/B11	The setting of command BB:C2K:BST:CGR:COFF:WCOD is adjusted according to the selection	Device-specific

[SOURce<[1]>:]BB:C2K:PPARAmeter:EXECute

This command presets the channel table of base station 1 with the parameters defined by the PPARAmeter commands.

The command triggers an event and therefore has no query form and no \*RST value.

**Example:** "BB:C2K:PPAR:EXECute"  
'configures the signal sequence as defined by the :BB:C2K:PPARAmeter commands.

*RST value	Resolution	Options	SCPI
-	-	B10/B11 and B13 K46 SOURce2 only with second option B9/B10/B11	Device-specific

[SOURce<[1]|2>:]BB:C2K:PPARameter:PCHannel[:STATe] ON | OFF

The command activates/deactivates the paging channel.

The setting takes effect only after execution of command :SOURce:BB:C2K:PPARameter:EXEC.

**Example:** "BB:C2K:PPAR:PCH ON"  
'activates F-PCH.

*RST value	Resolution	Options	SCPI
ON	-	B10/B11 and B13 K46 SOURce2 only with second option B9/B10/B11	Device-specific

[SOURce<[1]|2>:]BB:C2K:PPARameter:PICHannel[:STATe] ON | OFF

The command activates/deactivates the pilot channel.

The setting takes effect only after execution of command :SOURce:BB:C2K:PPARameter:EXEC.

**Example:** "BB:C2K:PPAR:PICH ON"  
'activates F-PICH.

*RST value	Resolution	Options	SCPI
ON	-	B10/B11 and B13 K46 SOURce2 only with second option B9/B10/B11	Device-specific

[SOURce<[1]|2>:]BB:C2K:PPARameter:RCONfiguration 1 | 2 | 3 | 4 | 5

The command selects the radio configuration for the traffic channel.

The setting takes effect only after execution of command :SOURce:BB:C2K:PPARameter:EXEC.

**Example:** "BB:C2K:PPAR:RCON 1"  
'selects radio configuration 1.

*RST value	Resolution	Options	Dependencies	SCPI
1	-	B10/B11 and B13 K46 SOURce2 only with second option B9/B10/B11	The R&S Vector Signal Generator provides a separate set of settings of all channel table parameters for each radio configuration. If the radio configuration is changed, the set of channel table values belonging to this RC is automatically activated.	Device-specific

[SOURce<[1]>:]BB:C2K:PPARameter:SCHannel[:STATe] ON | OFF

The command activates/deactivates the F-SYNC

The setting takes effect only after execution of command SOUR:BB:C2K:PPARameter:EXEC.

**Example:** "BB:C2K:PPAR:SCH ON"  
'activates the F-SYNC.

*RST value	Resolution	Options	SCPI
ON	-	B10/B11 and B13 K46 SOURce2 only with second option B9/B10/B11	Device-specific

[SOURce<[1]>:]BB:C2K:PPARameter:TCHannel:COUNT 0 ... 8

This command sets the number of activated traffic channels.

The setting takes effect only after execution of command :SOURce:BB:C2K:PPARameter:EXEC.

**Example:** "BB:C2K:PPAR:TCH:COUN 2"  
'the predefined signal contains 2 traffic channels.

*RST value	Resolution	Options	SCPI
1	-	B10/B11 and B13 K46 SOURce2 only with second option B9/B10/B11	Device-specific

[SOURce<[1]>:]BB:C2K:PPARameter:TCHannel:DATA:RATE

DR1K2 | DR1K3 | DR1K5 | DR1K8 | DR2K4 | DR2K7 | DR3K6 | DR4K8 | DR7K2 | DR9K6 | DR14K4 | DR19K2 | DR28K8 | DR38K4 | DR57K6 | DR76K8 | DR115K2 | DR153K6 | DR230K4 | DR259K2 | DR307K2 | DR460K8 | DR518K4 | DR614K4 | DR1036K8

This command sets the data rate of F-FCH and F-SCH. The set value is specific for the selected radio configuration.

The setting takes effect only after execution of command :SOURce:BB:C2K:PPARameter:EXEC.It is specific for the selected radio configuration.

**Example:** "BB:C2K:PPAR:TCH:DATA:RATE D240K"  
'sets the data rate of F-FCH and F-SCH to 240 kbps.

*RST value	Resolution	Options	Dependencies	SCPI
DR1K2	-	B10/B11 and B13 K46 SOURce2 only with second option B9/B10/B11	The value range depends on the frame length. If the frame length is changed so that the set data rate becomes invalid, the next permissible value is automatically set.  The data rate affects the Walsh code (spreading factor) that are possible within a channel. If a data rate is changed so that the selected Walsh code becomes invalid, the next permissible value is automatically set.	Device-specific

[SOURce<[1]>:]BB:C2K:PPARameter:TCHannel:DCCHannel[:STATe] ON | OFF

The command activates/deactivates the dedicated control channel. F-DCCH can not be selected for RC1 and RC2.

The setting takes effect only after execution of command : SOURce:BB:C2K:PPARameter:EXEC. It is specific for the selected radio configuration.

**Example:** "BB:C2K:PPAR:TCH:DCCH ON"  
'activates F-DCCH.

*RST value	Resolution	Options	SCPI
ON	-	B10/B11 and B13 K46 SOURce2 only with second option B9/B10/B11	Device-specific

[SOURce<[1]>:]BB:C2K:PPARameter:TCHannel:FCHannel[:STATe] ON | OFF

The command activates/deactivates the fundamental channel.

The setting takes effect only after execution of command : SOURce:BB:C2K:PPARameter:EXEC. It is specific for the selected radio configuration.

**Example:** "BB:C2K:PPAR:TCH:FCH ON"  
'activates F-FCH.

*RST value	Resolution	Options	SCPI
ON	-	B10/B11 and B13 K46 SOURce2 only with second option B9/B10/B11	Device-specific

[SOURce<[1]>:]BB:C2K:PPARameter:TCHannel:FLENgth 20 ms | 40 ms | 80 ms

The command sets the frame length of the code channels. The set value is specific for the selected radio configuration.

The setting takes effect only after execution of command : SOURce:BB:C2K:PPARameter:EXEC. It is specific for the selected radio configuration.

**Example:** "BB:C2K:PPAR:TCH:FLEN 20 ms"  
'sets the frame length of the code channels to 20 ms.

*RST value	Resolution	Options	Dependencies	SCPI
20 ms	-	B10/B11 and B13 K46 SOURce2 only with second option B9/B10/B11	The frame length affects the data rates that are possible within a channel. Changing the frame length may lead to a change of data rate and this in turn may bring about a change of Walsh code.	Device-specific

[SOURce<[1]|2>:]BB:C2K:PPARameter:TCHannel:SCHannel:COUNT 1 ... 7

The command defines the number of supplemental channels. The maximum number of supplemental channels depends on the selected radio configuration.

The setting takes effect only after execution of command SOUR:BB:C2K:PPARameter:EXEC. It is specific for the selected radio configuration.

**Example:** "BB:C2K:PPAR:TCH:SCH:COUN 2"  
'selects two F-SCHs.

*RST value	Resolution	Options	SCPI
1	-	B10/B11 and B13 K46 SOURce2 only with second option B9/B10/B11	Device-specific

## SOURce:BB:C2K - Setting Base Stations

The SOURce:BB:C2K:BSTation system contains commands for setting base stations. The commands of this system only take effect if the CDMA2000 standard is activated, the DOWN transmission direction is selected and the particular base station is enabled:

```
SOURce:BB:C2K:STATe ON
```

```
SOURce:BB:C2K:LINK DOWN
```

```
SOURce:BB:C2K:BSTation2:STATe ON
```

---

### Important:

*The channel table for the base station is configured from fourteen special channels and up to eight traffic channels. Each traffic channel consists of four to eight code channels. The type and number of code channels depends on the radio configuration chosen for the traffic channel.*

*The individual channels are selected in SCPI via the suffixes to keywords CGRoup and COFFset.*

*The special channel have the suffix 0 to CGRoup and 1 to 14 to COFFset corresponding to the channel index 0-1 to 0-14 in the channel table.*

*The code channels of a traffic channel are addressed by means of suffixes 1 to 8 for the traffic channel and 1 to 8 to COFFset for the sub channels of the selected traffic channel. Thus CGRoup2:COFFset1 is the code channel F-FCH of the traffic channel 2 and equates to the channel index 2-1 in the channel table.*

---

Structure of the traffic channel for different radio configurations.

	Radio Configuration 1, 2	Radio Configuration 3,4,5
1-1 (CGRoup1:COFFset1)	F-FCH	F-FCH
1-2 (CGRoup1:COFFset2)	F-SCH1	F-SCH1
1-3 (CGRoup1:COFFset3)	F-SCH2	F-SCH2
1-4 (CGRoup1:COFFset4)	F-SCH3	F-DCCH
1-5 (CGRoup1:COFFset5)	F-SCH4	-
1-6 (CGRoup1:COFFset6)	F-SCH5	-
1-7 (CGRoup1:COFFset7)	F-SCH6	-
1-8 (CGRoup1:COFFset8)	F-SCH7	-

---

### Important:

*Regardless of the radio configuration, in all traffic channels the COFFset1 corresponds to the F-FCH, and the COFFset2 and COFFset3 correspond to the F-SCH1 and F-SCH2, respectively. In radio configurations 1 and 2 the COFFset4 corresponds to the F-SCH3, and in radio configurations 3, 4, 5 to the F-DCCH. COFFset5, COFFset6, COFFset7 and COFFset8 exist only in radio configurations 1 and 2, where they correspond to the F-SCH4 to F-SCH7.*

### Important:

*For the code channels of a traffic channels, the settings of the channel table parameters are specific for the selected radio configuration. I.e. a complete set of settings exists for each of the five possible radio configurations.*

---

Command	Parameter	Default Unit	Comments
[SOURce<[1]2>:]BB:C2K:BSTation<[1]2 3 4>:CGRoup<0 [1]...8>:COF Fset<[1]...13>:CCODing:BINTerleaver			Query only
[SOURce<[1]2>:]BB:C2K:BSTation<[1]2 3 4>:CGRoup<0 [1]...8>:COF Fset<[1]...13>:CCODing:BITFrame			Query only
[SOURce<[1]2>:]BB:C2K:BSTation<[1]2 3 4>:CGRoup<0 [1]...8>:COF Fset<[1]...13>:CCODing:CRC			Query only
[SOURce<[1]2>:]BB:C2K:BSTation<[1]2 3 4>:CGRoup<0 [1]...8>:COF Fset<[1]...13>:CCODing:DATA:RATE			Query only
[SOURce<[1]2>:]BB:C2K:BSTation<[1]2 3 4>:CGRoup<0 [1]...8>:COF Fset<[1]...13>:CCODing:MODE	OFF   COMPLETE   OINterleaving   NOINterleaving		
[SOURce<[1]2>:]BB:C2K:BSTation<[1]2 3 4>:CGRoup<0 [1]...8>:COF Fset<[1]...13>:CCODing:SPUNcture			Query only
[SOURce<[1]2>:]BB:C2K:BSTation<[1]2 3 4>:CGRoup<0 [1]...8>:COF Fset<[1]...13>:CCODing:SREPetition			Query only
[SOURce<[1]2>:]BB:C2K:BSTation<[1]2 3 4>:CGRoup<0 [1]...8>:COF Fset<[1]...13>:CCODing:TYPE	CON2   CON3   CON4   CON6   TUR2   TUR3   TUR4   TUR5   OFF   DEFault		
[SOURce<[1]2>:]BB:C2K:BSTation<[1]2 3 4>:CGRoup<0 [1]...8>:COF Fset<[1]...14>:DATA	PN9   PN11   PN15   PN16   PN20   PN21   PN23   DLISt   ZERO   ONE   PATTern		
[SOURce<[1]2>:]BB:C2K:BSTation<[1]2 3 4>:CGRoup<0 [1]...8>:COF Fset<[1]...14>:DATA:DSElect	<dlist_name>		
[SOURce<[1]2>:]BB:C2K:BSTation<[1]2 3 4>:CGRoup<0 [1]...8>:COF Fset<[1]...14>:DATA:PATTern	#B0...B111..1, 1...64		
[SOURce<[1]2>:]BB:C2K:BSTation<[1]2 3 4>:CGRoup<0 [1]...8>:COF Fset<[1]...11>:DATA:RATE	DR1K2   DR1K3   DR1K5   DR1K8   DR2K4   DR2K7   DR3K6   DR4K8   DR7K2   DR9K6   DR14K4   DR19K2   DR28K8   DR38K4   DR57K6   DR76K8   DR115K2   DR153K6   DR230K4   DR259K2   DR307K2   DR460K8   DR518K4   DR614K4   DR1036K8   NUSed		
[SOURce<[1]2>:]BB:C2K:BSTation[1]:CGRoup<0 1>:COFFset<[1]...7>:DERRor:BIT:RATE	1E-7...10E-1		
[SOURce<[1]2>:]BB:C2K:BSTation[1]:CGRoup<0 1>:COFFset<[1]...7>:DERRor:BIT:STATE	ON   OFF		
[SOURce<[1]2>:]BB:C2K:BSTation[1]:CGRoup<0 1>:COFFset<[1]...7>:DERRor:BLOCK:RATE	1E-4...10E-1		
[SOURce<[1]2>:]BB:C2K:BSTation[1]:CGRoup<0 1>:COFFset<[1]...7>:DERRor:BLOCK:STATE	ON   OFF		
[SOURce<[1]2>:]BB:C2K:BSTation<[1]2 3 4>:CGRoup<0 [1]...8>:COF Fset<[1]...11>:FLENgth	5ms   10ms   20ms   26ms   40ms   80ms   160ms	s	
[SOURce<[1]2>:]BB:C2K:BSTation<[1]2 3 4>:CGRoup<[1]...8>:COFFset<[1]...8>:LCMask	#H0 .. #H3FF FFFF FFFF		
[SOURce<[1]2>:]BB:C2K:BSTation<[1]2 3 4>:CGRoup<0 [1]...8>:COF Fset<[1]...14>:POWER	-80 dB ... 0 dB	dB	
[SOURce<[1]2>:]BB:C2K:BSTation<[1]2 3 4>:CGRoup<0 [1]...8>:COF Fset<[1]...13>:QWCode:STATE	ON   OFF		

Command	Parameter	Default Unit	Comments
[SOURce<[1]2>:]BB:C2K:BSTation[1]:CGRoup<0 1>:COFFset<[1]...7>:REALtime:STATe	ON   OFF		
[SOURce<[1]2>:]BB:C2K:BSTation<[1]2 3 4>:CGRoup<0 [1]...8>:COFFset<[1]...14>:STATe	ON   OFF		
[SOURce<[1]2>:]BB:C2K:BSTation<[1]2 3 4>:CGRoup<[1]...8>:COFFset<[1]4>:TPC:DATA	DLISt   ZERO   ONE   PATTeRn		
[SOURce<[1]2>:]BB:C2K:BSTation<[1]2 3 4>:CGRoup<[1]...8>:COFFset<[1]4>:TPC:DATA:DSElect	<list_name>		
[SOURce<[1]2>:]BB:C2K:BSTation<[1]2 3 4>:CGRoup<[1]...8>:COFFset<[1]4>:TPC:DATA:PATTeRn	#B0,1...B111...1, 64		
[SOURce<[1]2>:]BB:C2K:BSTation<[1]2 3 4>:CGRoup<[1]...8>:COFFset<[1]4>:TPC:MISUse	ON   OFF		
[SOURce<[1]2>:]BB:C2K:BSTation<[1]2 3 4>:CGRoup<[1]...8>:COFFset<[1]4>:TPC:PSTep	-10 dB ...+10 dB	dB	
[SOURce<[1]2>:]BB:C2K:BSTation<[1]2 3 4>:CGRoup<[1]...8>:COFFset<[1]4>:TPC:READ	CONTInuous   SOA   S1A   S01A   S10A		
[SOURce<[1]2>:]BB:C2K:BSTation<[1]2 3 4>:CGRoup<0 [1]...8>:COFFset<[1]...14>:TYPE			Query only
[SOURce<[1]2>:]BB:C2K:BSTation<[1]2 3 4>:CGRoup<0 [1]...8>:COFFset<[1]...13>:WCODe	0 ... 255		
[SOURce<[1]2>:]BB:C2K:BSTation<[1]2 3 4>:CGRoup<0 [1]...8>:COFFset<[1]...13>:WLENgth			Query only
[SOURce<[1]2>:]BB:C2K:BSTation<[1]2 3 4>:CGRoup<[1]...8>:RCONf igiturion	1 ... 5		
[SOURce<[1]2>:]BB:C2K:BSTation<[1]2 3 4>:DCONflict:MODE	HAD   BREV		
[SOURce<[1]2>:]BB:C2K:BSTation<[1]2 3 4>:DCONflict:RESolve			No query
[SOURce<[1]2>:]BB:C2K:BSTation<[1]2 3 4>:DCONflict[:STATe]			
[SOURce<[1]2>:]BB:C2K:BSTation<[1]2 3 4>:PDCHannel:PINTerval	5 ms ... 2000 ms	s	
[SOURce<[1]2>:]BB:C2K:BSTation<[1]2 3 4>:PDCHannel:PSETup	ON   OFF		
[SOURce<[1]2>:]BB:C2K:BSTation<[1]2 3 4>:PDCHannel:SUBPacket <[1]...8>ID	0 ... 3		
[SOURce<[1]2>:]BB:C2K:BSTation<[1]2 3 4>:PDCHannel:SUBPacket <[1]...8>PARAmeters	1 .. 127		
[SOURce<[1]2>:]BB:C2K:BSTation<[1]2 3 4>:PDCHannel:SUBPacket <[1]...8>STATe	ON   OFF		
[SOURce<[1]2>:]BB:C2K:BSTation<[1]2 3 4>:PDCHannel:SUBPacket <[1]...8>TOFFset	0 ... 1000 slots		
[SOURce<[1]2>:]BB:C2K:BSTation<[1]2 3 4>:PDCHannel:SUBPacket <[1]...8>WCODes			Query only
[SOURce<[1]2>:]BB:C2K:BSTation<[1]2 3 4>:PDCHannel:WINDex	0 ... 3		
[SOURce<[1]2>:]BB:C2K:BSTation<[1]2 3 4>:PNOFFset	0 ... 511		
[SOURce<[1]2>:]BB:C2K:BSTation<[1]2 3 4>:QWSet	1 ...3		
[SOURce<[1]2>:]BB:C2K:BSTation:PRESet			No query
[SOURce<[1]2>:]BB:C2K:BSTation<[1]2 3 4>:STATe	ON   OFF		
[SOURce<[1]2>:]BB:C2K:BSTation<2 3 4>:TDELay	0...98 304 chips		
[SOURce<[1]2>:]BB:C2K:BSTation<[1]2 3 4>:TDIVersity	OFF   ANT1   ANT2		
[SOURce<[1]2>:]BB:C2K:BSTation<[1]2 3 4>:TDIVersity:MODE	OTD   STS		



[SOURce<[1]|2>:]BB:C2K:BSTation<[1]|2|3|4>:CGRoup<0|[1]...8>:COFFset<[1]...13>:CCODing:BI  
Nterleaver?

The command queries the number of symbols per block which are processed by the interleaver. This value is only available for channel coding modes **Complete** and **Without Interleaving** (SOURce:BB:C2K:BST<n>:CGRoup<n>:COFFset<n>:CCODing:MODE COMP | NOIN).

The command is a query and therefore does not have an \*RST value. For the traffic channels, this value is specific for the selected radio configuration.

**Example:** "BB:C2K:BST:CGR3:COFF1:CCOD:MODE COMP"  
'selects channel coding mode **Complete** for F-FCH of the third traffic channel.

"BB:C2K:BST:CGR3:COFF1:CCOD:BI NTerleaver?"  
'queries the number of symbols per block which are processed by the interleaver.

Response: 384  
'384 symbols per block are processed.

*RST value	Resolution	Options	SCPI
-	-	B10/B11 and B13 K46 SOURce2 only with second option B9/B10/B11	Device-specific

[SOURce<[1]|2>:]BB:C2K:BSTation<[1]|2|3|4>:CGRoup<0|[1]...8>:COFFset<[1]...13>:CCODing:BI  
TFrame?

The command queries the number of input bits per frame for the channel coder. This value is only available for channel coding modes **Complete** and **Without Interleaving** (SOURce:BB:C2K:BST<n>:CGRoup<n>:COFFset<n>:CCODing:MODE COMP | NOIN).

The command is a query and therefore does not have an \*RST value. For the traffic channels, this value is specific for the selected radio configuration.

**Example:** "BB:C2K:BST:CGR3:COFF1:CCOD:MODE COMP"  
'selects channel coding mode **Complete** for F-FCH of the third traffic channel.

"BB:C2K:BST:CGR3:COFF1:CCOD:BITF?"  
'queries the number of input bits per frame.

Response: 16  
'16 bits per frame.

*RST value	Resolution	Options	SCPI
-	-	B10/B11 and B13 K46 SOURce2 only with second option B9/B10/B11	Device-specific

[SOURce<[1]|2>:]BB:C2K:BSTation<[1]|2|3|4>:CGRoup<0|[1]...8>:COFFset<[1]...13>:CCODing:CR?

The command queries the CRC (cyclic redundancy code) type (length). This value is only available for channel coding modes **Complete** and **Without Interleaving**

(SOURce:BB:C2K:BST<n>:CGRoup<n>:COFFset<n>:CCODing:MODE COMP | NOIN).

The command is a query and therefore does not have an \*RST value. For the traffic channels, this value is specific for the selected radio configuration.

**Example:** "BB:C2K:BST:CGR1:COFF1:CCOD:MODE COMP"  
'selects channel coding mode **Complete** for F-FCH of the first traffic channel.

"BB:C2K:BST:CGR1:COFF1:CCOD:CR?"  
'queries the CRC type.

Response: "6"  
'CRC type 6 is used.

*RST value	Resolution	Options	SCPI
-	-	B10/B11 and B13 K46 SOURce2 only with second option B9/B10/B11	Device-specific

[SOURce<[1]|2>:]BB:C2K:BSTation<[1]|2|3|4>:CGRoup<0|[1]...8>:COFFset<[1]...13>:CCODing:DATA:RATE?

The command queries the effective data rate in Hz. This value is only available for channel coding modes **Off** and **Interleaving Only**

(SOURce:BB:C2K:BST<n>:CGRoup<n>:COFFset<n>:CCODing:MODE OFF | OINT).

When channel coding is switched off, the effective data rate differs from the data rate set in the channel table. The data are read out with the effective rate.

The command is a query and therefore does not have an \*RST value. For the traffic channels, this value is specific for the selected radio configuration.

**Example:** "BB:C2K:BST:CGR3:COFF1:CCOD:MODE OINT"  
'selects channel coding mode **Interleaving Only** for F-FCH of the third traffic channel.

"BB:C2K:BST:CGR3:COFF1:CCOD:DATA:RATE?"  
'queries the effective data rate.

Response: "19200"  
'the effective data is 19.2 kbps.

*RST value	Resolution	Options	SCPI
-	-	B10/B11 and B13 K46 SOURce2 only with second option B9/B10/B11	Device-specific

[SOURce<[1]|2>:]BB:C2K:BSTation<[1]|2|3|4>:CGRoup<0|[1]...8>:COFFset<[1]...13>:CCODing:MODE OFF | COMPlEte | OINTErleaving | NOINTErleaving

The command selects channel coding mode. For the traffic channels, this value is specific for the selected radio configuration.

**Parameter: OFF**  
Channel coding is deactivated.

**COMPlEte**  
The complete channel coding is performed. The channel coding procedure may slightly vary depending on channel type, frame length and data rate.

**OINTErleaving**  
Except for the block interleaver, the whole channel coding procedure is carried out. In this mode the frame structure and the convolutional coder of an receiver can be tested.

**NOINTErleaving**  
In this mode only block interleaver is used for coding. This allows the deinterleaver in the receiver to be tested independently of the remaining (de-)coding process.

**Example:** "BB:C2K:BST:CGR3:COFF1:CCOD:MODE OFF"  
'deactivates channel coding for F-FCH of the third traffic channel.

*RST value	Resolution	Options	SCPI
COMPlEte	-	B10/B11 and B13 K46 SOURce2 only with second option B9/B10/B11	Device-specific

[SOURce<[1]|2>:]BB:C2K:BSTation<[1]|2|3|4>:CGRoup<0|[1]...8>:COFFset<[1]...13>:CCODing:SPUNcture?

The command queries the symbol puncture rate. This value is only available for channel coding modes **Complete** and **Without Interleaving**  
(SOURce:BB:C2K:BST<n>:CGRoup<n>:COFFset<n>:CCODing:MODE COMP | NOIN).

The command is a query and therefore does not have an \*RST value. For the traffic channels, this value is specific for the selected radio configuration.

**Parameter: xOFy**  
a symbol puncture rate of x out of y is used.

**TxOFy**  
a symbol puncture rate of x out of y Turbo is used.

**Example:** "BB:C2K:BST:CGR3:COFF1:CCOD:MODE COMP"  
'selects channel coding mode **Complete** for F-FCH of the third traffic channel.

"BB:C2K:BST:CGR3:COFF1:CCOD:SPUN?"  
'queries the symbol puncture rate.

Response: "8OF24"  
'a symbol puncture rate of 8 out of 24 is used.

*RST value	Resolution	Options	SCPI
-	-	B10/B11 and B13 K46 SOURce2 only with second option B9/B10/B11	Device-specific

[SOURce<[1]|2>:]BB:C2K:BSTation<[1]|2|3|4>:CGRoup<0|[1]...8>:COFFset<[1]...13>:CCODing:S REPetition?

The command queries symbol repetition rate. This value is only available for channel coding modes **Complete** and **Without Interleaving**

(SOURce:BB:C2K:BST<n>:CGRoup<n>:COFFset<n>:CCODing:MODE COMP | NOIN).

The command is a query and therefore does not have an \*RST value. For the traffic channels, this value is specific for the selected radio configuration.

**Example:** "BB:C2K:BST:CGR3:COFF1:CCOD:MODE COMP"  
'selects channel coding mode **Complete** for F-FCH of the third traffic channel.

"BB:C2K:BST:CGR3:COFF1:CCOD:SREP?"  
'queries symbol repetition rate.

Response: "8"  
'a symbol repetition rate of 8 is used.

*RST value	Resolution	Options	SCPI
-	-	B10/B11 and B13 K46 SOURce2 only with second option B9/B10/B11	Device-specific

[SOURce<[1]|2>:]BB:C2K:BSTation<[1]|2|3|4>:CGRoup<0|[1]...8>:COFFset<[1]...13>:CCODing:TYPE CON2 | CON3 | CON4 | CON6 | TUR2 | TUR3 | TUR4 | TUR5 | OFF | DEFault

The command sets the channel coding type.

This value is only available for channel coding modes **Complete** and **Without Interleaving** (SOURce:BB:C2K:BST<n>:CGRoup<n>:COFFset<n>:CCODing:MODE COMP | NOIN). For the traffic channels, this value is specific for the selected radio configuration.

**Parameter:** **NONE**  
No error protection

**TURx**  
Turbo Coder of rate 1/x in accordance with the CDMA specifications.

**CONx**  
Convolution Coder of rate 1/x with generator polynomials defined by CDMA.

**Example:** "BB:C2K:BST:CGR3:COFF2:CCOD:MODE COMP"  
'selects channel coding mode **Complete** for F-SCH1 of the third traffic channel.

"BB:C2K:BST:CGR3:COFF2:CCOD:TYPE TURB4"  
'selects turbo coder with a rate of 1/4 for F-SCH1 of the third traffic channel.

*RST value	Resolution	Options	SCPI
Channel-specific	-	B10/B11 and B13 K46 SOURce2 only with second option B9/B10/B11	Device-specific

[SOURce<[1]|2>:]BB:C2K:BSTation<[1]|2|3|4>:CGRoup<0|[1]...8>:COFFset<[1]...13>:DATA PN9 | PN11 | PN15 | PN16 | PN20 | PN21 | PN23 | DLISt | ZERO | ONE | PATTern

The command selects the data source for the specified channel.

For the traffic channels, this value is specific for the selected radio configuration.

The data source for the power control bits is selected with the command

:BB:C2K:BST<n>:CGRoup<n>:COFFset<n>:TPC:DATA.

**Parameter:**

**PNxx**

The pseudo-random sequence generator is used as the data source. Different random sequence lengths can be selected.

**DLISt**

A data list is used. The data list is selected with the command

:BB:C2K:BST<n>:CGRoup<n>:COFFset<n>:DATA:DSEL.

**ZERO | ONE**

Internal 0 and 1 data is used.

**PATTern**

Internal data is used The bit pattern for the data is defined by the command

:BB:C2K:BST:CGRoup:COFFset:DATA:PATT.

**Example:**

"BB:C2K:BST2:CGR3:COFF1:DATA PATT"

"selects as the data source for the F-FCH of the third traffic channel of base station 2, the bit pattern defined with the following command:

"BB:C2K:BST2:CGR3:COFF1:DATA:PATT #H3F,8"

'defines the bit pattern.

*RST value	Resolution	Options	SCPI
F-PICH/ F-TDPICH/ F-APICH F-ATDPICH: ALL0 all other channels: PN9	-	B10/B11 and B13 K46 SOURce2 only with second option B9/B10/B11	Device-specific

[SOURce<[1]|2>:]BB:C2K:BSTation<[1]|2|3|4>:CGRoup<0|[1]...8>:COFFset<[1]...13>:DATA:DSELECT <data list name>

The command selects the data list for the DLIS data source selection.

The lists are stored as files with the fixed file extensions \*.dm\_iqd in a directory of the user's choice. The directory applicable to the following commands is defined with the command MMEMoRY:CDIR. To access the files in this directory, you only have to give the file name, without the path and the file extension.

For the traffic channels, this value is specific for the selected radio configuration.

**Example:** "BB:C2K:BST2:CGR3:COFF1:DATA DLIS"  
 'selects the Data Lists data source for the F-FCH of the third traffic channel of basestation 2.  
 "MMEM:CDIR 'D:\Lists\DM\IqData'"  
 'selects the directory for the data lists.  
 "BB:C2K:BST2:CGR3:COFF1:DATA:DLIS 'cdma\_list1'"  
 'selects file 'cdma\_list1' as the data source. This file must be in the directory D:\Lists\DM\IqData and have the file extension \*.dm\_iqd.

*RST value	Resolution	Options	SCPI
-	-	B10/B11 and B13 K46 SOURce2 only with second option B9/B10/B11	Device-specific

[SOURce<[1]|2>:]BB:C2K:BSTation<[1]|2|3|4>:CGRoup<0|[1]...8>:COFFset<[1]...13>:DATA:PATTERN #B0,1 ... #B111..1,64

The command sets the bit pattern for the PATtern selection. The first parameter determines the bit pattern (choice of hexadecimal, octal or binary notation), the second specifies the number of bits to use. The maximum length is 64 bits.

For the traffic channels, this value is specific for the selected radio configuration.

**Example:** "BB:C2K:BST2:CGR3:COFF1:DATA:PATT #H800FE038,30"  
 'defines the bit pattern.

*RST value	Resolution	Options	SCPI
0	-	B10/B11 and B13 K46 SOURce2 only with second option B9/B10/B11	Device-specific

[SOURce<[1]|2>:]BB:C2K:BSTation<[1]|2|3|4>:CGRoup<0|[1]...8>:COFFset<[1]...13>:DATA:RATE  
 DR1K2 | DR1K3 | DR1K5 | DR1K8 | DR2K4 | DR2K7 | DR3K6 | DR4K8 | DR7K2 | DR9K6 | DR14K4 |  
 DR19K2 | DR28K8 | DR38K4 | DR57K6 | DR76K8 | DR115K2 | DR153K6 | DR230K4 | DR259K2 |  
 DR307K2 | DR460K8 | DR518K4 | DR614K4 | DR1036K8 | NUSed

The command sets the data rate for the specified channel. The value range depends on the channel type, the selected radio configuration and the frame length. Parameter NUSed is returned for channel 0-1 to 0-4.

For the traffic channels, this value is specific for the selected radio configuration.

**Example:** "BB:C2K:BST2:CGR3:COFF1:DATA:RATE DR4K8"  
 'sets a data rate of 4.8 kbps for F-FCH of the third traffic channel of base station2.

*RST value	Resolution	Options	Dependencies	SCPI
Channel-specific	-	B10/B11 and B13 K46 SOURce2 only with second option B9/B10/B11	The value range depends on the frame length. If the frame length is changed so that the set data rate becomes invalid, the next permissible value is automatically set. The data rate affects the Walsh code (spreading factor) that are possible within a channel. If a data rate is changed so that the selected Walsh code becomes invalid, the next permissible value is automatically set.	Device-specific

[SOURce<[1]|2>:]BB:C2K:BSTation:CGRoup<0|1>:COFFset<[1]...7>:DERRor:BIT:RATE 1E-7 .. 1E-1 (0.0000001...0.1)

The command sets the bit error rate.

This command is available only for the realtime channels of base station 1.

**Example:** "BB:C2K:BST:CGR1:COFF3:REAL:STAT ON"  
 'activates the real time generation of F-SCH2 of the first traffic channel of base station1.  
 "BB:C2K:BST:CGR1:COFF3:DERR:BIT:RATE 1E-4"  
 'sets a bit error rate of 0.0001.

*RST value	Resolution	Options	SCPI
1E-3	-	B10/B11 and B13 K46 SOURce2 only with second option B9/B10/B11	Device-specific

[SOURce<[1]|2>:]BB:C2K:BSTation[1]:CGRoup<0|1>:COFFset<[1]...7>:DERRor:BIT:STATe ON | OFF

The command activates bit error generation.

This command is available only for the realtime channels of base station 1.

**Example:** "BB:C2K:BST:CGR1:COFF3:REAL:STAT ON"  
'activates the real time generation of F-SCH2 of the first traffic channel of base station 1.

"BB:C2K:BST:CGR1:COFF3:DERR:BIT:STAT ON"  
'activates bit error generation.

*RST value	Resolution	Options	SCPI
OFF	-	B10/B11 and B13 K46 SOURce2 only with second option B9/B10/B11	Device-specific

[SOURce<[1]|2>:]BB:C2K:BSTation[1]:CGRoup<0|1>:COFFset<[1]...7>:DERRor:BLOCK:RATE 1E-4 .. 1E-1 (0.0001...0.1)

The command sets the block error rate.

Block error generation is only possible when channel coding is activated. This command is available only for the realtime channels of base station 1. For the traffic channels, this value is specific for the selected radio configuration.

**Example:** "BB:C2K:BST:CGR1:COFF3:REAL:STAT ON"  
'activates the real time generation of F-SCH2 of the first traffic channel of base station 1.

"BB:C2K:BST:CGR1:COFF3:CCOD:MODE COMP"  
'activates complete channel coding.

"BB:C2K:BST:CGR1:COFF3:DERR:BLOC:RATE 1E-2"  
'sets the block error rate to 0.01.

"BB:C2K:BST:CGR1:COFF3:DERR:BLOC:STAT ON"  
'activates block error generation.

*RST value	Resolution	Options	SCPI
1E-1	-	B10/B11 and B13 K46 SOURce2 only with second option B9/B10/B11	Device-specific



**[SOURce<[1]|2>:]BB:C2K:BSTation[1]:CGRoup<0|1>:COFFset<[1]...7>:DERRor:BLOCK:STATe ON | OFF**

The command activates or deactivates block error generation.

This command is available only for the realtime channels of base station 1.

- Example:** "BB:C2K:BST:CGR1:COFF3:REAL:STAT ON"  
 'activates the real time generation of F-SCH2 of the first traffic channel of base station 1.
- "BB:C2K:BST:CGR1:COFF3:CCOD:MODE COMP"  
 'activates complete channel coding.
- "BB:C2K:BST:CGR1:COFF3:DERR:BLOC:RATE 1E-2"  
 'sets the block error rate to 0.01.
- "BB:C2K:BST:CGR1:COFF3:DERR:BLOC:STAT ON"  
 'activates block error generation.

*RST value	Resolution	Options	SCPI
OFF	-	B10/B11 and B13 K46 SOURce2 only with second option B9/B10/B11	Device-specific

**[SOURce<[1]|2>:]BB:C2K:BSTation<[1]|2|3|4>:CGRoup<0|[1]...8>:COFFset<[1]...11>:FLENgth 5 ms | 10 ms | 20 ms | 26 ms | 40ms | 80 ms | 160 ms**

The command sets the frame length of the selected channel. The value range is channel specific.

For the traffic channels, this value is specific for the selected radio configuration.

- Parameter:** **26 ms**  
 Frame length of 26,6. Also all inputs between 26.6 and 26.7 ms are allowed.

- Example:** "BB:C2K:BST:CGR3:COFF4:FLEN 5 ms'  
 'sets the frame length of sub channel 3-4 to 5 ms.

*RST value	Resolution	Options	Dependencies	SCPI
F-SYNC: 26.6 F_BCH: 40 ms F_CACH: 5 ms all other channels: 20 ms	-	B10/B11 and B13 K46 SOURce2 only with second option B9/B10/B11	The value range of the frame length depends on the channel type and the selected radio configuration.  The frame length affects the data rates that are possible within a channel. Changing the frame length may lead to a change of data rate and this in turn may bring about a change of Walsh code.	Device-specific

[SOURce<[1]|2>:]BB:C2K:BSTation<[1]|2|3|4>:CGRoup<[1]...8>:COFFset<[1]...8>:LCMask #H0 ... #H3FF FFFF FFFF

The command sets the mask of the Long Code Generator of the base station.

For the traffic channels, this value is specific for the selected radio configuration.

**Example:** "BB:C2K:BST1:CGR2:COFF1:LCM #H55"  
 'sets the Long Code Mask to #H55 .

*RST value	Resolution	Options	Dependencies	SCPI
#H0	-	B10/B11 and B13 K46 SOURce2 only with second option B9/B10/B11	The LC Mask is the same for all sub channels of a traffic channel. If the mask is modified for one of the sub channels the new value is then automatically used by all other subchannels of this traffic channel.	Device-specific

[SOURce<[1]|2>:]BB:C2K:BSTation<[1]|2|3|4>:CGRoup<0|[1]...8>:COFFset<[1]...13>:POWER -80 dB... 0 dB

The command sets the channel power relative to the powers of the other channels. This setting also determines the starting power of the channel for Misuse Output Power Control.

With the command SOURce:BB:C2K:POWer:ADJust , the power of all the activated channels is adapted so that the total power corresponds to 0 dB. This will not change the power ratio among the individual channels.

For the traffic channels, this value is specific for the selected radio configuration.

**Example:** "BB:C2K:BST2:CGR3:COFF4:POW -10dB"  
 'sets the channel power of sub channel 3-4 of base station 2 to -10 dB relative to the power of the other channels.

*RST value	Resolution	Options	SCPI
Channel-specific	0.01 dB	B10/B11 and B13 K46 SOURce2 only with second option B9/B10/B11	Device-specific

[SOURce<[1]|2>:]BB:C2K:BSTation<[1]|2|3|4>:CGRoup<0|[1]...8>:COFFset<[1]...13>:QWCode:STATe ON | OFF

This command activates/deactivates the use of the quasi orthogonal Walsh codes for the channel.

The quasi orthogonal Walsh Code set is selected for all channels of the base station with command SOUR:BB:C2K:BST:QWSet.

For the traffic channels, this value is specific for the selected radio configuration. It is only available for radio configuration 3 and higher

**Example:** "BB:C2K:BST1:QWS 3"  
 'selects quasi orthogonal Walsh code set 3 for base station 1.  
 "BB:C2K:BST1:CGR3:COFF4:QWC:STAT ON"  
 'activates the use of the quasi orthogonal Walsh code for sub channel 3-4.

*RST value	Resolution	Options	SCPI
OFF		B10/B11 and B13 K46 SOURce2 only with second option B9/B10/B11	Device-specific

[SOURce<[1]|2>:]BB:C2K:BSTation:CGRoup<0|1>:COFFset<[1]...7>:REALtime:STATe ON | OFF

This command activates/deactivates realtime generation of the selected channel. Realtime generation is possible for F-SYNC and the first traffic channel of base station 1.

For the traffic channel, this value is specific for the selected radio configuration.

**Example:** "BB:C2K:BST:CGR0:COFF5:REAL:STAT ON"  
 'activates realtime generation of F-SYNC of base station 1.

*RST value	Resolution	Options	SCPI
OFF	-	B10/B11 and B13 K46 SOURce2 only with second option B9/B10/B11	Device-specific

[SOURce<[1]|2>:]BB:C2K:BSTation<[1]|2|3|4>:CGRoup<0|[1]...8>:COFFset<[1]...14>:STATe ON | OFF

This command activates/deactivates the selected channel.

For the traffic channels, this value is specific for the selected radio configuration.

**Example:** "BB:C2K:BST2:CGR1:COFF2:STAT OFF"  
 'deactivates sub channel 1-2 of base station 1.

*RST value	Resolution	Options	SCPI
Off	-	B10/B11 and B13 K46 SOURce2 only with second option B9/B10/B11	Device-specific

**[SOURce<[1]|2>:]BB:C2K:BSTation<[1]|2|3|4>:CGRoup<[1]...8>:COFFset<[1]|4>:TPC:DATA  
DLISt | ZERO | ONE | PATTern**

The command determines the data source for the power control bits of the selected F-FCH or F-DCCH.

Power control is available for sub channel types F-FCH and F-DCCH. F-DCCH is only generated for radio configurations 3, 4 and 5.

For the traffic channels, this value is specific for the selected radio configuration.

**Parameter:**

**DLISt**

A data list is used. The data list is selected with the command  
BB:C2K:BST:CGR:COFF:TPC:DATA:DSEL.

**ZERO | ONE**

Internal 0 and 1 data is used.

**PATTern**

Internal data is used The bit pattern for the data is defined by the command  
BB:C2K:BST:CGR:COFF:TPC:DATA:PATTern. The maximum length is 64 bits.

**Example:**

"BB:C2K:BST2:CGR1:RCON 4"

'selects radio configuration4 for the first traffic channel of base station 2. This setting is valid for all sub channels of this traffic channel. With RC4, the traffic channel includes a F-DCCH.

"BB:C2K:BST2:CGR1:COFF4:TPC:DATA PATT"

'selects as the data source for the power control bits of F-DCCH the bit pattern defined with the following command.

"BB:C2K:BST2:CGR1:COFF4:TPC:DATA:PATT #HF0C20,19"

'defines the bit pattern.

*RST value	Resolution	Options	SCPI
ZERO	-	B10/B11 and B13 K46 SOURce2 only with second option B9/B10/B11	Device-specific

[SOURce<[1]|2>:]BB:C2K:BSTation<[1]|2|3|4>:CGRoup<[1]...8>:COFFset<[1]|4>:TPC:DATA:DSElect <data list name>

The command selects the data list for the DLIS data source selection.

Power control is available for sub channel types F-DCCH and F-FCH. F-DCCH is only generated for radio configurations 3, 4 and 5.

The lists are stored as files with the fixed file extensions \*.dm\_iqd in a directory of the user's choice. The directory applicable to the following commands is defined with the command MMEMory:CDIR. To access the files in this directory, you only have to give the file name, without the path and the file extension.

For the traffic channels, this value is specific for the selected radio configuration.

**Example:** "BB:C2K:BST2:CGR1:RCON 4"  
 'selects radio configuration RC4 for the first traffic channel of base station 2. This setting is valid for all sub channels of the traffic channel. With RC4, the traffic channel includes a F-DCCH.

:BB:C2K:BST2:CGR1:COFF4:TPC:DATA DLIS"  
 'selects the DLIS data source.

"MMEM:CDIR 'D:\Lists\DM\IqData'"  
 'selects the directory for the data lists.

"BB:C2K:BST2:CGR1:COFF4:TPC:DATA:DSEL 'cdma\_ch4'"  
 'selects the file 'cdma\_ch4' as the data source. This file must be in the directory D:\Lists\DM\IqData and have the file extension \*.dm\_iqd.

*RST value	Resolution	Options	SCPI
-	-	B10/B11 and B13 K46 SOURce2 only with second option B9/B10/B11	Device-specific

[SOURce<[1]|2>:]BB:C2K:BSTation<[1]|2|3|4>:CGRoup<[1]...8>:COFFset<[1]|4>:TPC:DATA:PATTERn #B0,1 ... #B111..1, 64

The command determines the bit pattern for the PATTERN selection. The maximum bit pattern length is 64 bits.

Power control is available for sub channel types F-DCCH and F-FCH. F-DCCH is only generated for radio configurations 3, 4 and 5.

For the traffic channels, this value is specific for the selected radio configuration.

**Example:** "BB:C2K:BST2:CGR1:RCON 4"  
 'selects radio configuration RC4 for the first traffic channel of base station 2. This setting is valid for all sub channels of the traffic channel. With RC4, the traffic channel includes a F-DCCH.

"BB:C2K:BST2:CGR1:COFF4:TPC:DATA:PATT #H3F,8"  
 'defines the bit pattern for the power control-bits.

*RST value	Resolution	Options	SCPI
#H0,1	-	B10/B11 and B13 K46 SOURce2 only with second option B9/B10/B11	Device-specific

[SOURce<[1]|2>:]BB:C2K:BSTation<[1]|2|3|4>:CGRoup<[1]...8>:COFFset<[1]|4>:TPC:MISuse ON | OFF

The command activates "mis-" use of the power control bits of the selected F-DCCH or F-FCH for controlling the channel powers of these channels.

Power control is available for sub channel types F-DCCH and F-FCH. F-DCCH is only generated for radio configurations 3, 4 and 5.

The bit pattern (see commands :BB:C2K:BSTation<n>:CGRoup<n>:COFFset<n>:TPC... ) of the power control bits of each channel is used to control the channel power. A "1" leads to an increase of channel powers, a "0" to a reduction of channel powers. Channel power is limited to the range 0 dB to -80 dB. The step width of the change is defined with the command :BB:C2K:BSTation<n>:CGRoup<n>:COFFset<n>:TPC:PSTep.

For the traffic channels, this value is specific for the selected radio configuration.

**Example:** "BB:C2K:BST2:CGR1:RCON 4"  
 'selects radio configuration RC4 for the first traffic channel of base station 2. This setting is valid for all sub channels of the traffic channel. With RC4, the traffic channel includes a F-DCCH.

"BB:C2K:BST2:CGR1:COFF4:TPC:MIS ON"  
 'activates regulation of channel power for DCCH of the first traffic channel of base station 2 via the power control bit pattern.

"BB:C2K:BST2:CGR1:COFF4:TPC:PST 1 dB"  
 'sets the step width for the change of channel powers to 1 dB.

*RST value	Resolution	Options	SCPI
OFF	-	B10/B11 and B13 K46 SOURce2 only with second option B9/B10/B11	Device-specific

[SOURce<[1]|2>:]BB:C2K:BSTation<[1]|2|3|4>:CGRoup<[1]...8>:COFFset<[1]|4>:TPC:PSTep -10.0 ... 10.0 dB

The command defines the step width for the change of channel powers in the case of "mis-" use of the power control bits.

Power control is available for sub channel types F-DCCH and F-FCH. F-DCCH is only generated for radio configurations 3, 4 and 5.

For the traffic channels, this value is specific for the selected radio configuration.

**Example:** "BB:C2K:BST2:CGR1:RCON 4"  
 'selects radio configuration RC4 for the first traffic channel of base station 2. This setting is valid for all sub channels of the traffic channel. With RC4, the traffic channel includes a F-DCCH.

"BB:C2K:BST2:CGR1:COFF4:TPC:PST 1 dB"  
 'sets the step width for the change of channel powers to 1 dB.

*RST value	Resolution	Options	SCPI
0	0.01 dB	B10/B11 and B13 K46 SOURce2 only with second option B9/B10/B11	Device-specific

[SOURce<[1]|2>:]BB:C2K:BSTation<[1]|2|3|4>:CGRoup<[1]...8>:COFFset<[1]|4>:TPC:READ  
 CONTInuous | S0A | S1A | S01A | S10A

The command sets the read out mode for the bit pattern of the power control bits.

The bit pattern is defined with the commands

:BB:C2K:BST<n>:CGRoup<n>:COFFset<n>:TPC . . .

Power control is available for sub channel types F-DCCH and F-FCH. F-DCCH is only generated for radio configurations 3, 4 and 5.

For the traffic channels, this value is specific for the selected radio configuration.

**Parameter:**

**CONTInuous**

The bit pattern is used cyclically.

**S0A**

The bit pattern is used once, then the power control bit sequence continues with 0 bits.

**S1A**

The bit pattern is used once, then the power control bit sequence continues with 1 bits.

**S01A**

The bit pattern is used once and then the power control bit sequence is continued with 0 and 1 bits alternately.

**S10A**

The bit pattern is used once and then the power control bit sequence is continued with 1 and 0 bits alternately.

**Example:**

"BB:C2K:BST2:CGR1:RCON 4"

'selects radio configuration RC4 for the first traffic channel of base station 2. This setting is valid for all sub channels of the traffic channel. With RC4, the traffic channel includes a F-DCCH.

"BB:C2K:BST2:CGR1:COFF4:TPC:READ S0A"

"the bit pattern is used once, after which a 0 sequence is generated (applies to F-DCCH of the first traffic channel of base station 2).

*RST value	Resolution	Options	SCPI
CONTInuous		B10/B11 and B13 K46 SOURce2 only with second option B9/B10/B11	Device-specific

[SOURce<[1]|2>:]BB:C2K:BSTation<[1]|2|3|4>:CGRoup<0|[1]...8>:COFFset<[1]...14>:TYPE?

The command queries the channel type.

The channel type is firmly fixed for channel numbers 0-1 to 0-14 (CGR0:COFF1 to CGR0:COFF14), i.e. for the special channels (control and packet channels). The remaining channel numbers are assigned to the individual code channels of the eight possible traffic channels. In this case the first traffic channel occupies the range 1-1 to 1-8 (CGR1:COFF1 to CGR1:COFF8), the second occupies the range 2-1 to 2-8 (CGR2:COFF1 to CGR2:COFF8), etc. Since the type and number of code channels depends on the radio configuration of the channel, the channels x-2 to x-8 are variously occupied. X-1 is always the fundamental channel (F-FCH) of the traffic channel.

The command is a query and therefore does not have an \*RST value.

<b>Parameter:</b>	<b>F-PICH</b>	Pilot Channel
	<b>F-SYNC</b>	Sync Channel
	<b>F-PCH</b>	Paging Channel
	<b>F-TDPICH</b>	Transmit Diversity Pilot Channel.
	<b>F-APICH</b>	Auxiliary Pilot Channel
	<b>F-ATDPICH</b>	Auxiliary Transmit Diversity Pilot Channel
	<b>F-BCH</b>	Broadcast Channel
	<b>F-CPCCH</b>	Common Power Control Channel
	<b>F-QPCH</b>	Quick Paging Channel
	<b>F-CACH</b>	Common Assignment Channel
	<b>F-CCCH</b>	Common Control Channel
	<b>F-DCCH</b>	Dedicated Control Channel
	<b>F-FCH</b>	Fundamental Channel
	<b>F-SCH</b>	Supplemental Channel
	<b>F-PDCCH</b>	Packet Data Control Channel
	<b>F-PDCH</b>	Forward Packet Data Channel

**Example:** "BB:C2K:BST2:CGR0:COFF12:TYPE?"  
'queries type of channel 0-12 of base station 2.

Response: "F-PDCCH"  
'channel 0-12 is a Packet Dedicated Control Channel.

*RST value	Resolution	Options	SCPI
	-	B10/B11 and B13 K46 SOURce2 only with second option B9/B10/B11	Device-specific



[SOURce<[1]|2>:]BB:C2K:BSTation<[1]|2|3|4>:CGRoup<0|[1]...8>:COFFset<[1]...13>:WCODe 0 ... 255

The command assigns the Walsh Code to the channel. The standard assigns a fixed walsh code to some channels (F-PICH, for example, always uses Walsh code 0). Generally, the Walsh code can only be varied within the range specified by the standard.

For the traffic channels, this value is specific for the selected radio configuration.

**Example:** "BB:C2K:BST1:CGR3:COFF5:WCOD 23"  
'assigns Walsh code 23 to sub channel 3-5 of base station 1.

*RST value	Resolution	Options	Dependencies	SCPI
Channel-specific	1	B10/B11 and B13 K46 SOURce2 only with second option B9/B10/B11	The value range of the Walsh code depends on the frame length, the channel coding type and the data rate.  If one of these parameters is changed so that the set Walsh code gets invalid, the next permissible value is automatically set.	Device-specific

[SOURce<[1]|2>:]BB:C2K:BSTation<[1]|2|3|4>:CGRoup<0|[1]...8>:COFFset<[1]...13>:WLEnGth

The command queries the Walsh Code length of the channel. For the traffic channels, this value is specific for the selected radio configuration.

The command is a query and therefore does not have an \*RST value.

**Example:** "BB:C2K:BST1:CGR3:COFF5:WLEN?"  
'queries Walsh code length of sub channel 3-5 of base station 1.

Response: "64"  
'the Walsh code length is 64

*RST value	Resolution	Options	SCPI
	-	B10/B11 and B13 K46 SOURce2 only with second option B9/B10/B11	Device-specific

[SOURce<[1]|2>:]BB:C2K:BSTation<[1]|2|3|4>:CGRoup<[1]...8>:RCONfiguration 1 | 2 | 3 | 4 | 5

The command selects the radio configuration for the traffic channel. The settings of the channel table parameters are specific for the selected radio configuration.

**Example:** "BB:C2K:BST2:CGR1:RCON 4"  
'selects radio configuration RC4 for the first traffic channel of base station 2.  
This setting is valid for all sub channels of the traffic channel. With RC4, the traffic channel includes a F-DCCH.

*RST value	Resolution	Options	Dependencies	SCPI
Traffic channel 1/2: 3 all other traffic channels: 1	-	B10/B11 and B13 K46 SOURce2 only with second option B9/B10/B11	The R&S Vector Signal Generator provides a separate set of settings of all channel table parameters for each radio configuration. If the radio configuration is changed, the set of channel table values belonging to this RC is automatically activated.	Device-specific

[SOURce<[1]|2>:]BB:C2K:BSTation<[1]|2|3|4>:DCONflict:MODE

The command switches the order of the spreading codes.

The command is a query and therefore does not have an \*RST value.

**Parameter:** HAD

the code channels are displayed in the order determined by the Hadamard matrix. The codes are numbered as Walsh codes according to the standard.

**BREV**

the code channels are displayed in the order defined by the Orthogonal Variable Spreading Factor (OVSF) code tree (3GPP code).

**Example:**

"BB:C2K:BST2:DCON:MODE HAD"

'selects that the codes are numbered as Walsh codes according to the standard.

*RST value	Resolution	Options	SCPI
HAD	-	B10/B11 and B13 K46 SOURce2 only with second option B9/B10/B11	Device-specific

[SOURce<[1]|2>:]BB:C2K:BSTation<[1]|2|3|4>:DCONflict:RESolve

The command resolves existing domain conflicts by modifying the Walsh codes of the affected channels.

The command is an event and therefore does not have an \*RST value and a query form.

**Example:** "BB:C2K:BST2:DCON:STAT?"

'queries whether a code domain conflict exists for base station 2.

'Response: "1"

'there is a conflict.

"BB:C2K:BST2:DCON:RES"

'resolves the code domain error by modifying the Walsh codes of the affected channels.

*RST value	Resolution	Options	SCPI
-	-	B10/B11 and B13 K46 SOURce2 only with second option B9/B10/B11	Device-specific

**[SOURce<[1]|2>:]BB:C2K:BSTation<[1]|2|3|4>:DCONflict[:STATe]?**

The command queries whether there is (response 1) or is not (response 0) a conflict (overlap) in the hierarchically-structured Walsh codes.

The command is a query and therefore does not have an \*RST value.

**Example:** "BB:C2K:BST2:DCON:STAT?"  
 'queries whether a code domain conflict exists for base station 2.  
 "Response: "0"  
 'there is no conflict.

*RST value	Resolution	Options	SCPI
-	-	B10/B11 and B13 K46 SOURce2 only with second option B9/B10/B11	Device-specific

**[SOURce<[1]|2>:]BB:C2K:BSTation<[1]|2|3|4>:PDCH:PINTerval 5 ms ... 2000 ms**

The command sets the interval between two data packets for F-PDCH. The range depends on the ARB settings sequence length (:BB:C2K:SLENgth). The values 80 ms, 40 ms, 20 ms, 10 ms and 5 ms can always be set, and the maximum value is 2000 ms. All intermediate values must satisfy the condition

$$\text{Sequence Length} * 80\text{ms}/2^n$$

where n is a whole number.

**Example:** "BB:C2K:BST2:PDCH:PINT 10 ms"  
 'sets an interval of 10 ms between two data packets.

*RST value	Resolution	Options	SCPI
20 ms	-	B10/B11 and B13 K46 SOURce2 only with second option B9/B10/B11	Device-specific

[SOURce<[1]|2>:]BB:C2K:BSTation<[1]|2|3|4>:PDCH:PSETup ON | OFF

The command selects for F-PDCH if all subpackets are generated using the same settings or if the settings of subchannel 1 are valid for all sub channels. However, the value of **Number of Bits per Encoder Packet** is a quality of the complete encoder packet, therefore it is always set for all sub packet channels via the entry for sub channel 1.

**Parameter: ON**  
 packet parameters can be changed only for sub packet 1, all sub packets are generated with these settings.

**OFF**  
 packet parameters can be set individually for each sub packet.

**Example:** "BB:C2K:BST2:PDCH:PSET OFF"  
 'selects that all sub packets can be configured separately.

*RST value	Resolution	Options	SCPI
ON	-	B10/B11 and B13 K46 SOURce2 only with second option B9/B10/B11	Device-specific

[SOURce<[1]|2>:]BB:C2K:BSTation<[1]|2|3|4>:PDCH:SUBPacket<[1]...8>:ID 0...3

The command selects the sub packet ID for F\_PDCH. The sub packet ID determines the sub packet symbol selection and selects one of four available subpackets of the encoder packets. The SPID of sub packet 1 is always 1.

**Example:** "BB:C2K:BST2:PDCH:SUBP3:ID 3"  
 'selects SPID 3 for sub packet 3.

*RST value	Resolution	Options	SCPI
0	-	B10/B11 and B13 K46 SOURce2 only with second option B9/B10/B11	Device-specific

[SOURce<[1]|2>:]BB:C2K:BSTation<[1]|2|3|4>:PDCH:SUBPacket<[1]...8>:PARAmeters 1...127

The command selects a fixed combination of parameters **Bits per Encoder Packet**, **Number of 32-Chip Walsh Channels**, **Subpacket Data Rate**, **Number of Slots per Subpackets** and **Modulation Order**. These combinations are shown in the following list in the form of a table for all five parameters.

The complete range of 127 possible combinations is only available for subpacket 1. If **Same Packet Setup for all Subpackets** is enabled (SOUR:BB:C2K:BST2:PDCH:PSET ON), this command is only valid for subpacket 1.

**Example:** "BB:C2K:BST2:PDCH:SUBP1:PAR 48"  
 'selects combination of parameters with index 48 (see following table).

*RST value	Resolution	Options	SCPI
1	-	B10/B11 and B13 K46 SOURce2 only with second option B9/B10/B11	Device-specific

Parameter of command SOUR:BB:C2K:BST: PDCH:PAR	Number of Bits per Encoder Packet	Number of 32- Chip Walsh Channels	Subpacket Data Rate (kbps)	Number of Slots per Subpacket	Modulation Order
1	2328	28	1862.4	1	8-PSK
2	3864	27	1545.6	2	QPSK
3	3096	26	2476.8	1	16-QAM
4	3864	26	3091.2	1	16-QAM
5	1560	25	1248.0	1	QPSK
6	2328	25	1862.4	1	8-PSK
7	3096	25	1238.4	2	QPSK
8	3864	25	1545.6	2	8-PSK
9	2328	23	931.2	2	QPSK
10	2328	23	1862.4	1	16-QAM
11	3096	23	2476.8	1	16-QAM
12	3864	23	1545.6	2	8-PSK
13	1560	22	1248.0	1	QPSK
14	3096	22	1238.4	2	QPSK
15	1560	21	1248.0	1	8-PSK
16	3096	21	1238.4	2	8-PSK
17	3096	21	2476.8	1	16-QAM
18	3864	21	1545.6	2	8-PSK
19	1560	20	624.0	2	QPSK
20	2328	20	465.6	4	QPSK
21	2328	20	931.2	2	QPSK
22	2328	20	1862.4	1	16-QAM
23	3096	20	619.2	4	QPSK
24	408	19	326.4	1	QPSK
25	792	19	316.8	2	QPSK
26	792	19	633.6	1	QPSK
27	1560	19	1248.0	1	8-PSK
28	3096	19	1238.4	2	8-PSK
29	3864	19	772.8	4	QPSK
30	3864	19	1545.6	2	16-QAM
31	2328	18	1862.4	1	16-QAM
32	1560	17	1248.0	1	8-PSK
33	2328	17	931.2	2	QPSK
34	3096	17	1238.4	2	8-PSK
35	3864	17	1545.6	2	16-QAM
36	2328	16	1862.4	1	16-QAM
37	3096	16	619.2	4	QPSK
38	3864	16	772.8	4	QPSK
39	792	15	633.6	1	QPSK
40	1560	15	624.0	2	QPSK
41	1560	15	1248.0	1	16-QAM
42	2328	15	931.2	2	8-PSK
43	3096	15	1238.4	2	16-QAM
44	3864	15	1545.6	2	16-QAM

Parameter of command SOUR:BB:C2K:BST: PDCH:PAR	Number of Bits per Encoder Packet	Number of 32-Chip Walsh Channels	Subpacket Data Rate (kbps)	Number of Slots per Subpacket	Modulation Order
45	1560	14	312.0	4	QPSK
46	2328	14	465.6	4	QPSK
47	3864	14	772.8	4	QPSK
48	3864	14	1545.6	2	16-QAM
49	792	13	633.6	1	QPSK
50	1560	13	624.0	2	QPSK
51	1560	13	1248.0	1	16-QAM
52	2328	13	931.2	2	8-PSK
53	3096	13	619.2	4	QPSK
54	3096	13	1238.4	2	16-QAM
55	3864	13	1545.6	2	16-QAM
56	1560	12	1248.0	1	16-QAM
57	3096	12	1238.4	2	16-QAM
58	3864	12	772.8	4	8-PSK
59	408	11	326.4	1	QPSK
60	792	11	158.4	4	QPSK
61	792	11	316.8	2	QPSK
62	792	11	633.6	1	QPSK
63	1560	11	624.0	2	QPSK
64	1560	11	1248.0	1	16-QAM
65	2328	11	465.6	4	QPSK
66	2328	11	931.2	2	16-QAM
67	3096	11	619.2	4	QPSK
68	3096	11	1238.4	2	16-QAM
69	3864	11	772.8	4	8-PSK
70	792	10	633.6	1	8-PSK
71	1560	10	624.0	2	8-PSK
72	2328	10	931.2	2	16-QAM
73	3096	10	619.2	4	8-PSK
74	792	9	633.6	1	8-PSK
75	1560	9	312.0	4	QPSK
76	1560	9	624.0	2	8-PSK
77	2328	9	465.6	4	QPSK
78	2328	9	931.2	2	16-QAM
79	3096	9	619.2	4	8-PSK
80	3864	9	772.8	4	16-QAM
81	408	8	163.2	2	QPSK
82	408	8	326.4	1	QPSK
83	792	8	316.8	2	QPSK
84	792	8	633.6	1	16-QAM
85	1560	8	624.0	2	16-QAM
86	2328	8	465.6	4	8-PSK
87	2328	8	931.2	2	16-QAM
88	3096	8	619.2	4	16-QAM
89	3864	8	772.8	4	16-QAM

Parameter of command SOUR:BB:C2K:BST: PDCH:PAR	Number of Bits per Encoder Packet	Number of 32-Chip Walsh Channels	Subpacket Data Rate (kbps)	Number of Slots per Subpacket	Modulation Order
90	408	7	326.4	1	QPSK
91	792	7	316.8	2	QPSK
92	792	7	633.6	1	16-QAM
93	1560	7	312.0	4	QPSK
94	1560	7	624.0	2	16-QAM
95	2328	7	465.6	4	8-PSK
96	3096	7	619.2	4	16-QAM
97	3864	7	772.8	4	16-QAM
98	408	6	326.4	1	QPSK
99	792	6	158.4	4	QPSK
100	792	6	316.8	2	QPSK
101	792	6	633.6	1	16-QAM
102	1560	6	312.0	4	QPSK
103	1560	6	624.0	2	16-QAM
104	2328	6	465.6	4	16-QAM
105	3096	6	619.2	4	16-QAM
106	408	5	163.2	2	QPSK
107	408	5	326.4	1	8-PSK
108	792	5	316.8	2	8-PSK
109	1560	5	312.0	4	8-PSK
110	2328	5	465.6	4	16-QAM
111	408	4	81.6	4	QPSK
112	408	4	163.2	2	QPSK
113	408	4	326.4	1	16-QAM
114	792	4	158.4	4	QPSK
115	792	4	316.8	2	16-QAM
116	1560	4	312.0	4	16-QAM
117	2328	4	465.6	4	16-QAM
118	408	3	81.6	4	QPSK
119	408	3	163.2	2	QPSK
120	408	3	326.4	1	16-QAM
121	792	3	158.4	4	QPSK
122	792	3	316.8	2	16-QAM
123	1560	3	312.0	4	16-QAM
124	408	2	81.6	4	QPSK
125	408	2	163.2	2	16-QAM
126	792	2	158.4	4	16-QAM
127	408	1	81.6	4	16-QAM

[SOURce<[1]|2>:]BB:C2K:BSTation<[1]|2|3|4>:PDCH:SUBPacket<[1]...8>:STATe ON | OFF

This command activates/deactivates the selected sub packet for F\_PDCH. Sub packet 1 is always active.

**Example:** "BB:C2K:BST2:PDCH:SUBP3:STAT ON"  
'activates sub packet 3.

*RST value	Resolution	Options	SCPI
OFF	-	B10/B11 and B13 K46 SOURce2 only with second option B9/B10/B11	Device-specific

[SOURce<[1]|2>:]BB:C2K:BSTation<[1]|2|3|4>:PDCH:SUBPacket<[1]...8>:TOFFset 0 ... 1000 Slots

The command sets start of the sub packet relative to the start of the packet interval. The offset is entered in slots. Sub packet 1 has offset 0. The value range for the individual subpackets depends on the settings of the other subpackets. The time slot offsets of the other sub packet have to be entered in ascending order. Also, two packets cannot be sent at the same time.

In total the maximum value depends on the selected packet interval and the number of slots per sub packet as follows:

*Packet Interval/1.25 ms - Number of Slots per Subpacket.*

**Example:** "BB:C2K:BST2:PDCH:SUBP3:TOFF 4"  
'enters at time slot offset of 4 slots. Sub packet 3 is sent 4 slots after the begin of the packet interval.

*RST value	Resolution	Options	SCPI
0	-	B10/B11 and B13 K46 SOURce2 only with second option B9/B10/B11	Device-specific

[SOURce<[1]|2>:]BB:C2K:BSTation<[1]|2|3|4>:PDCH:SUBPacket<[1]...8>:RESulting:WCODes?

The command queries the resulting Walsh codes for the selected sub packet of F-PDCH. Packet channels may be assigned to more than one code channel

The command is a query and therefore does not have an \*RST value.

**Example:** "BB:C2K:BST2:PDCH:SUBP3:RES:WCOD?"  
'queries the resulting Walsh codes for sub packet 3 of F-PDCH of base station 2.

Response: "31, 15, 23"  
'the resulting walsh codes are 31,15,23.

*RST value	Resolution	Options	SCPI
-	-	B10/B11 and B13 K46 SOURce2 only with second option B9/B10/B11	Device-specific



[SOURce<[1]|2>:]BB:C2K:BSTation<[1]|2|3|4>:PDCH:WINDex 0 | 1 | 2 | 3

The command selects a standard Walsh set for F-PDCH. Four different sets are defined in the standard.

**Example:** "BB:C2K:BST2:PDCH:WIND 2"  
'selects set 2 for PDCH of base station 2.

*RST value	Resolution	Options	SCPI
0	-	B10/B11 and B13 K46 SOURce2 only with second option B9/B10/B11	Device-specific

[SOURce<[1]|2>:]BB:C2K:BSTation<[1]|2|3|4>:PNOffset 0 ... 511

The command sets the PN offset (short code) of the base station. The PN offset permits signals of different base stations to be distinguished..

**Example:** "BB:C2K:BST3:PNOF 123"  
'sets a PN offset of 123 for base station 3.

*RST value	Resolution	Options	SCPI
0	-	B10/B11 and B13 K46 SOURce2 only with second option B9/B10/B11	Device-specific

[SOURce<[1]|2>:]BB:C2K:BSTation:PRESet

a standardized default for all the base stations. The settings correspond to the \*RST values specified for the commands. .

This command triggers an action and therefore has no \*RST value and no query form.

**Example:** "BB:C2K:BST:PRES"  
'resets all the base station settings to default values.

*RST value	Resolution	Options	Dependencies	SCPI
-	-	B10/B11 and B13 K46 SOURce2 only with second option B9/B10/B11	All base station settings are preset. An overview is provided by Table in chapter 4.	Device-specific

**[SOURce<[1]|2>:]BB:C2K:BSTation<[1]|2|3|4>:QWSet 1 | 2 | 3**

The command selects the quasi orthogonal Walsh code set. The standard defines three different sets.

The quasi-orthogonal Walsh codes are used for a given channel if

:SOURce:BB:C2K:BST<n>:CGRoup<n>:COFFset<n>:QWCode:STATe is ON.

**Example:** "BB:C2K:BST2:QWS 2"  
'selects set 2 for base station 2.

*RST value	Resolution	Options	SCPI
1	-	B10/B11 and B13 K46 SOURce2 only with second option B9/B10/B11	Device-specific

**[SOURce<[1]|2>:]BB:C2K:BSTation<[1]|2|3|4>:STATe ON | OFF**

The command activates and deactivates the specified base station.

**Example:** "BB:C2K:BST2:STAT OFF"  
'deactivates base station 2.

*RST value	Resolution	Options	SCPI
OFF	-	B10/B11 and B13 K46 SOURce2 only with second option B9/B10/B11	Device-specific

**[SOURce<[1]|2>:]BB:C2K:BSTation<2|3|4>:TDELay 0 ... 98304chips**

The command sets the time shift of the selected base station compared to base station 1 in chips.

The command is only valid for base stations 2, 3 and 4. So a suffix must be specified at BSTation (2, 3, or 4).

**Example:** "BB:C2K:BST2:TDEL 256"  
'shifts base station 2 by 256 chips compared to base station 1.

*RST value	Resolution	Options	SCPI
0		B10/B11 and B13 K46 SOURce2 only with second option B9/B10/B11	Device-specific

**[SOURce<[1]|2>:]BB:C2K:BSTation<[1]|2|3|4>:TDIVersity OFF| ANT1 | ANT2**

The command activates and deactivates signal calculation with transmit diversity (OFF). To activate transmit diversity, the antenna must be specify whose signals are to be simulated (ANT1 or ANT2): The diversity scheme is selected using command : SOURce:BB:C2K:BSTation:TDIV:MODE.

- Parameters:**
- OFF**  
No transmit diversity.
  - ANT1**  
Calculate and apply the output signal for antenna 1.
  - ANT2**  
Calculate and apply the output signal for antenna 2.

**Example:** "BB:C2K:BST2:TDIV ANT2"  
'activates transmit diversity, the signal of antenna 2 is simulated.

*RST value	Resolution	Options	SCPI
OFF	-	B10/B11 and B13 K46 SOURce2 only with second option B9/B10/B11	Device-specific

**[SOURce<[1]|2>:]BB:C2K:BSTation<[1]|2|3|4>:TDIVersity:MODE OTD | STS**

The command selects the diversity scheme.

Command : SOURce:BB:C2K:BSTation:TDIVersity activates transmit diversity and selects the antenna.

- Parameter:**
- OTD**  
Orthogonal Transmit Diversity Mode.
  - STS**  
Space Time Spreading Mode.

**Example:** "BB:C2K:BST2:TDIV:MODE OTD"  
'selects scheme OTD for Transmit Diversity.  
"BB:C2K:BST2:TDIV ANT2"  
'activates transmit diversity, the signal of antenna 2 is simulated.

*RST value	Resolution	Options	SCPI
OTD	-	B10/B11 and B13 K46 SOURce2 only with second option B9/B10/B11	Device-specific

## SOURce:BB:C2K - Mobile Station Settings

The SOURce:BB:C2K:MSTation system contains commands for setting the mobile stations. The commands of this system only take effect when the CDMA2000 standard is activated, the UP transmission direction is selected and the particular mobile station is enabled:

SOURce:BB:C2K:STATe ON

SOURce:BB:C2K:LINK UP

SOURce:BB:C2K:MSTation2:STATe ON

The channels of mobile station 1 are always generated in real time.

**Important:**

*For the code channels of a traffic channels, the settings of the channel table parameters are specific for the selected radio configuration. I.e. a complete set of settings exists for each of the four possible radio configurations.*

Command	Parameter	Default Unit	Comments
[SOURce<[1] 2>:]BB:C2K:MSTation:ADDITIONAL:COUNT	1...64		
[SOURce<[1] 2>:]BB:C2K:MSTation:ADDITIONAL:LCMask:STEP	#H1...#FFFFFF		
[SOURce<[1] 2>:]BB:C2K:MSTation:ADDITIONAL:POWER:OFFSet	-80dB ... 0dB	dB	
[SOURce<[1] 2>:]BB:C2K:MSTation:ADDITIONAL:STATe	ON   OFF		
[SOURce<[1] 2>:]BB:C2K:MSTation:ADDITIONAL:TDElay:STEP	0 ... 1535	Chips	
[SOURce<[1] 2>:]BB:C2K:MSTation:PRESet			No query
[SOURce<[1] 2>:]BB:C2K:MSTation<[1] 2 3 4>:CCODing:MODE	OFF   COMPLETE   NOINterleaving   OINterleaving		
[SOURce<[1] 2>:]BB:C2K:MSTation<[1] 2 3 4>:CHANnel<[1]...8>:DATA	PN9   PN11   PN15   PN16   PN20   PN21   PN23   ZERO   ONE   PATTErn		
[SOURce<[1] 2>:]BB:C2K:MSTation<[1] 2 3 4>:CHANnel<[1]...8>:DATA:DS ELect	<data_list>		
[SOURce<[1] 2>:]BB:C2K:MSTation<[1] 2 3 4>:CHANnel<[1]...8>:DATA:PA TTErn	#B0...B111...1, 1...64		
[SOURce<[1] 2>:]BB:C2K:MSTation<[1] 2 3 4>:CHANnel<[1]...8>:DATA:RA TE	DR1K2   DR1K3   DR1K5   DR1K8   DR2K4   DR2K7   DR3K6   DR4K8   DR7K2   DR9K6   DR14K4   DR19K2   DR28K8   DR38K4   DR57K6   DR76K8   DR115K2   DR153K6   DR230K4   DR259K2   DR307K2   DR460K8   DR518K4   DR614K4   DR1036K8   NUSed		
[SOURce<[1] 2>:]BB:C2K:MSTation<[1] 2 3 4>:CHANnel<[1]...8>:FLENgth	5 ms   10 ms   20 ms   40 ms   80 ms		
[SOURce<[1] 2>:]BB:C2K:MSTation<[1] 2 3 4>:CHANnel<[1]...8>:POWER	-80 dB ... 0 dB	dB	
[SOURce<[1] 2>:]BB:C2K:MSTation<[1] 2 3 4>:CHANnel<[1]...8>:SPREad			Query only

Command	Parameter	Default Unit	Comments
[SOURce<[1]>:]BB:C2K:MSTation<[1]> 2 3 4>:CHANnel<[1]...8>:STATe	ON   OFF		
[SOURce<[1]>:]BB:C2K:MSTation<[1]> 2 3 4>:CHANnel<[1]...8>:TYPE			Query only
[SOURce<[1]>:]BB:C2K:MSTation<[1]> 2 3 4>:CHANnel<[1]...5>:WCODE			Query only
[SOURce<[1]>:]BB:C2K:MSTation<[1]> 2 3 4>:LCMask	0 ... 3FF FFFF FFFF		
[SOURce<[1]>:]BB:C2K:MSTation<[1]> 2 3 4>:MODE	TRAFfic   ACCess   EACCess   CCONtrol		
[SOURce<[1]>:]BB:C2K:MSTation<[1]> 2 3 4>:RCONfiguration	1 ... 4		
[SOURce<[1]>:]BB:C2K:MSTation<[1]> 2 3 4>:STATe	ON   OFF		
[SOURce<[1]>:]BB:C2K:MSTation<[1]> 2 3 4>:TPC:DATA	DLISt   ZERO   ONE   PATTern		
[SOURce<[1]>:]BB:C2K:MSTation<[1]> 2 3 4>:TPC:DATA:DSElect	<list_name>		
[SOURce<[1]>:]BB:C2K:MSTation<[1]> 2 3 4>:TPC:DATA:PATTern	#H0,1 ... #HFF...,64		
[SOURce<[1]>:]BB:C2K:MSTation<[1]> 2 3 4>:TPC:MISuse	ON   OFF		
[SOURce<[1]>:]BB:C2K:MSTation<[1]> 2 3 4>:TPC:PSTep	-10 dB ...+10 dB		
[SOURce<[1]>:]BB:C2K:MSTation<[1]> 2 3 4>:TPC:READ	CONTInuous   S0A   S1A   S01A   S10A		

**[SOURce<[1]>:]BB:C2K:MSTation:ADDITIONAL:COUNT 1 ... 64**

The command sets the number of additional mobile stations

The R&S Vector Signal Generator provides the opportunity to simulate up to 64 additional mobile stations - corresponding to a receive signal for a base station with high capacity utilization. The fourth mobile station (MS4) serves as a template for all other stations. The only parameters of the additional mobile stations to be modified are the LC mask and the power. A time delay of the additional mobile stations to one another can be defined.

**Example:** "BB:C2K:MST:ADD:COUNT 20"  
 'sets 20 additional mobile stations.

"BB:C2K:MST:ADD:POW:OFFS -3.0"  
 'sets the power offset to -3 dB.

"BB:C2K:MST:ADD:LCM:STEP #H1"  
 'sets the step width for increasing the LC mask to 1.

"BB:C2K:MST:ADD:STAT ON"  
 'connects the 20 mobile stations to the CDMA signal.

*RST value	Resolution	Options	SCPI
4	-	B10/B11 and B13 K46 SOURce2 only with second option B9/B10/B11	Device-specific

**[SOURce<[1]>:]BB:C2K:MSTation:ADDITIONAL:LCMask:STEP #H1 ... #HFFFFFF**

The command sets the step width for increasing the LC mask of the additional mobile stations. The start value is the LC mask of MS4.

**Example:** "BB:C2K:MST:ADD:LCM:STEP #H55"  
 'sets the step width for increasing the long code mask to #H55.

*RST value	Resolution	Options	SCPI
#H1		B10/B11 and B13 K46 SOURce2 only with second option B9/B10/B11	Device-specific

**[SOURce<[1]>:]BB:C2K:MSTation:ADDITIONAL:POWER:OFFSet -80 dB... 0 dB**

The command sets the power offset of the active channels of the additional mobile stations relative to the power of the active channels of the reference station MS4.

The offset applies to all the additional mobile stations. The resultant overall power must fall within the range 0 ... - 80 dB. If the value is above or below this range, it is limited automatically.

**Example:** "BB:C2K:MST:ADD:POW:OFFS -3.0"  
 'sets the offset to -3 dB.

*RST value	Resolution	Options	SCPI
0 dB	0.1 dB	B10/B11 and B13 K46 SOURce2 only with second option B9/B10/B11	Device-specific

**[SOURce<[1]>:]BB:C2K:MSTation:ADDITIONAL:STATe ON | OFF**

The command activates additional mobile stations.

The suffix at MSTation has no significance for this command and should not be specified.

**Example:** "BB:C2K:MST:ADD:STAT ON"  
 'connects the additional mobile stations to the CDMA2000 signal.

*RST value	Resolution	Options	SCPI
OFF		B10/B11 and B13 K46 SOURce2 only with second option B9/B10/B11	Device-specific

[SOURce<[1]|2>:]BB:C2K:MSTation:ADDITIONal:TDELay:STEP 0...1535

The command sets the step width for the time delay of the additional mobile stations to one another. The start value returns the time delay of MS4. Entry is made in chips and can be a maximum of 1 frame.

**Example:** "BB:C2K:MST:ADD:TDEL:STEP 256"  
 'shifts each of the mobile stations 256 chips apart, starting from the time delay of MS4.

*RST value	Resolution	Options	SCPI
0 Chips	1 Chip	B10/B11 and B13 K46 SOURce2 only with second option B9/B10/B11	Device-specific

[SOURce<[1]|2>:]BB:C2K:MSTation<[1]|2|3|4>:CCODing:MODE

OFF | COMPLETE | OINTerleaving | NOINterleaving

The command selects the channel coding mode.

**Parameter: OFF**  
 Channel coding is deactivated.

**COMPLETE**  
 The complete channel coding is performed. The channel coding procedure may slightly vary depending on channel type, frame length and data rate.

**OINTerleaving**  
 Except for the block interleaver, the whole channel coding procedure is carried out.

**NOINterleaving**  
 In this mode only block interleaver is used for coding.

**Example:** "BB:C2K:MST:CCOD:MODE OFF"  
 'deactivates channel coding for mobile station 1.

*RST value	Resolution	Options	SCPI
OFF	-	B10/B11 and B13 K46 SOURce2 only with second option B9/B10/B11	Device-specific

**[SOURce<[1]2>:]BB:C2K:MSTation<[1]2|3|4>:CHANnel<[1]...8>:DATA**  
 PN9 | PN11 | PN15 | PN16 | PN20 | PN21 | PN23 | DLIS | ZERO | ONE | PATTErn

The command sets the data source for the specified channel.

The data source for the power control bits is selected with the command :BB:C2K:MST:TPC:DATA. For the traffic channels, this value is specific for the selected radio configuration.

**Parameter: PNxx**  
 The pseudo-random sequence generator is used as the data source. Different random sequence lengths can be selected.

**DLIS**  
 A data list is used. The data list is selected with the command :BB:C2K:MST:CHANnel<n>:DATA:DSElect.

**ZERO | ONE**  
 Internal 0 and 1 data is used.

**PATTErn**  
 Internal data is used. The bit pattern for the data is defined by the command SOURce:BB:C2K:MST:CHANnel<n>:DATA:PATTErn.

**Example:** "BB:C2K:MST1:CHAN2:DATA PN16"  
 'selects as the data source for channel 2 of mobile station 1, internal PRBS data with a sequence length of 2<sup>16</sup>-1.

*RST value	Resolution	Options	SCPI
PN9	-	B10/B11 and B13 K46 SOURce2 only with second option B9/B10/B11	Device-specific

**[SOURce<[1]2>:]BB:C2K:MSTation<[1]2|3|4>:CHANnel<[1]...8>:DATA:DSElect**  
 <data list name>

The command selects the data list for the DLIS data source selection.

The lists are stored as files with the fixed file extensions \*.dm\_iqd in a directory of the user's choice. The directory applicable to the following commands is defined with the command MMEMory:CDIR. To access the files in this directory, you only have to give the file name, without the path and the file extension.

For the traffic channels, this value is specific for the selected radio configuration.

**Example:** "BB:C2K:MST1:CHAN1:DATA DLIS"  
 'selects the Data Lists data source.  
 "MMEM:CDIR 'D:\Lists\Dm\IQData'"  
 'selects the directory for the data lists.  
 "BB:C2K:MST1:CHAN1:DATA:DSEL 'dpdch\_13'"  
 'selects file 'cdma\_13' as the data source. This file must be in the directory D:\Lists\DM\IQData and have the file extension \*.dm\_iqd.

*RST value	Resolution	Options	SCPI
-	-	B10/B11 and B13 K46 SOURce2 only with second option B9/B10/B11	Device-specific



**[SOURce<[1]|2>:]BB:C2K:MSTation<[1]|2|3|4>:CHANnel<[1]...8>:DATA:PATTERN #B0,1...B11...,64**

The command determines the bit pattern for the data component when the PATTERN data source is selected. The first parameter determines the bit pattern (choice of hexadecimal, octal or binary notation), the second specifies the number of bits to use. The maximum length is 64 bits.

For the traffic channels, this value is specific for the selected radio configuration.

**Example:** "BB:C2K:MST1:CHAN1:DATA PATT"  
 'selects Pattern data source.  
 "BB:C2K:MST1:CHAN1:DATA:PATT #H800FFFF80003FFE,60"  
 'defines the bit pattern.

*RST value	Resolution	Options	SCPI
0	-	B10/B11 and B13 K46 SOURce2 only with second option B9/B10/B11	Device-specific

**[SOURce<[1]|2>:]BB:C2K:MSTation<[1]|2|3|4>:CHANnel<[1]...8>:DATA:RATE DR1K2 | DR1K3 | DR1K5 | DR1K8 | DR2K4 | DR2K7 | DR3K6 | DR4K8 | DR7K2 | DR9K6 | DR14K4 | DR19K2 | DR28K8 | DR38K4 | DR57K6 | DR76K8 | DR115K2 | DR153K6 | DR230K4 | DR259K2 | DR307K2 | DR460K8 | DR518K4 | DR614K4 | DR1036K8**

The command sets the data rate for the specified channel. The value range depends on the channel type, the selected radio configuration and the frame length.

For the traffic channels, this value is specific for the selected radio configuration.

**Example:** "BB:C2K:MST2:MODE TRAF"  
 'selects operating mode traffic.  
 "BB:C2K:MST2:RCON 3"  
 'selects radio configuration 3 for the traffic channel.  
 "BB:C2K:MST2:CHAN3:DATA:RATE DR4K8"  
 'sets a data rate of 4.8 kbps for channel 3 of mobile station 2 (R-FCH in this configuration).

*RST value	Resolution	Options	Dependencies	SCPI
R-DCCH: DR9K6 R-FCH: DR1K5 R-SCH: DR1K5 R-ACC: DR4K8	-	B10/B11 and B13 K46 SOURce2 only with second option B9/B10/B11	The value range of the data rate depends on the channel type and the frame length. If the frame length is changed so that the set data rate becomes invalid, the next permissible value is automatically set.	Device-specific

[SOURce<[1]|2>:]BB:C2K:MSTation<[1]|2|3|4>:CHANnel<[1]...8>:FLEngth 5 ms | 10 ms | 20 ms | 40 ms | 80 ms

The command sets the frame length of the selected channel. The value range depends on the channel type and the selected radio configuration

For the traffic channels, this value is specific for the selected radio configuration.

**Example:** "BB:C2K:MST:CHAN3:FLEN 5 ms  
'sets the frame length of sub channel 3 to 5 ms.

*RST value	Resolution	Options	Dependencies	SCPI
20 ms	-	B10/B11 and B13 K46 SOURce2 only with second option B9/B10/B11	The frame length affects the data rates that are possible within a channel. Changing the frame length may lead to a change of data rate.	Device-specific

[SOURce<[1]|2>:]BB:C2K:MSTation<[1]|2|3|4>:CHANnel<[1]...8>:POWer -80 dB... 0 dB

The command sets the channel power relative to the powers of the other channels. This setting also determines the starting power of the channel for Misuse Output Power Control.

With the command SOURce:BB:C2K:POWer:ADJust, the power of all the activated channels is adapted so that the total power corresponds to 0 dB. This will not change the power ratio among the individual channels.

For the traffic channels, this value is specific for the selected radio configuration.

**Example:** "BB:C2K:MST2:CHAN3:POW -10dB"  
'sets the channel power of sub channel 3 of mobile station 2 to -10 dB relative to the power of the other channels.

*RST value	Resolution	Options	SCPI
0 dB	0.01 dB	B10/B11 and B13 K46 SOURce2 only with second option B9/B10/B11	Device-specific

[SOURce<[1]|2>:]BB:C2K:MSTation<[1]|2|3|4>:CHANnel<[1]...8>:SPRead?

The command queries the spreading factor of the channel. The spreading factor corresponds to the length of the employed Walsh code. The Walsh codes to be used are specified by the standard and cannot be chosen.

The command is a query and therefore does not have an \*RST value. For the traffic channels, this value is specific for the selected radio configuration.

**Example:** "BB:C2K:MST2:CHAN1:SPR?"  
'queries the spreading factor of channel 1 of mobile station 2.  
Response: "32"

*RST value	Resolution	Options	SCPI
-	-	B10/B11 and B13 K46 SOURce2 only with second option B9/B10/B11	Device-specific

[SOURce<[1]|2>:]BB:C2K:MSTation<[1]|2|3|4>:CHANnel<[1]...8>:STATe ON | OFF

This command activates/deactivates the selected channel.

For the traffic channels, this value is specific for the selected radio configuration.

**Example:** "BB:C2K:MST2:CHAN2:STAT OFF"  
'deactivates sub channel 2 of mobile station 2.

*RST value	Resolution	Options	SCPI
OFF	-	B10/B11 and B13 K46 SOURce2 only with second option B9/B10/B11	Device-specific

[SOURce<[1]|2>:]BB:C2K:MSTation<[1]|2|3|4>:CHANnel<[1]...8>:TYPE?  
R-PICH | R-ACH | R-EACH | R-CCCH | R-DCCH | R-FCH | R-SCCH | R-SCH2 | R-SCH1

The command queries the channel type. The channel type depends on the selected operating mode and, for the sub channels of the traffic channel, from the selected radio configuration.

The command is a query and therefore does not have an \*RST value.

- Parameter: R-ACH**  
Access Channel.
- R-EACH**  
Enhanced Access Channel
- R-CCCH**  
Common Control Channel
- R-PICH**  
Pilot Channel.
- R-DCCH**  
Dedicated Control Channel
- R-FCH**  
Fundamental Channel
- R-SCHx**  
Supplemental Channel 1 | 2
- R-SCCH**  
Supplemental Control Channel

**Example:** "BB:C2K:MST2:CHAN2:TYPE?"  
'queries type of channel 2.  
  
Response: "R-SCCH"  
'channel 2 is a Supplemental Control Channel.

*RST value	Resolution	Options	SCPI
	-	B10/B11 and B13 K46 SOURce2 only with second option B9/B10/B11	Device-specific

**[SOURce<[1]|2>:]BB:C2K:MSTation<[1]|2|3|4>:CHANnel<[1]...5>:WCODe?**

The command queries the Walsh code. The standard assigns a fixed walsh code to some channels. The command represents a query and thus has no \*RST value. For the traffic channels, this value is specific for the selected radio configuration.

**Example:**           "BB:C2K:MST1:CHAN3:WCODe?"  
                      'queries the Walsh code of channel 3 of mobile station 1.  
  
Response: "3"  
                      'the Walsh code is 3.

*RST value	Resolution	Options	SCPI
-	-	B10/B11 and B13 K46 SOURce2 only with second option B9/B10/B11	Device-specific

**[SOURce<[1]|2>:]BB:C2K:MSTation<[1]|2|3|4>:LCMask #H0 ... #H3FF FFFF FFFF**

The command sets the mask of the Long Code Generator of the mobile station.

**Example:**           "BB:C2K:MST1:LCM #H55"  
                      'sets the Long Codes to #H55 .

*RST value	Resolution	Options	SCPI
#H0		B10/B11 and B13 K46 SOURce2 only with second option B9/B10/B11	Device-specific

**[SOURce<[1]|2>:]BB:C2K:MSTation<[1]|2|3|4>:MODE TRAFfic | ACCess | EACCess | CCONtrol**

The command selects operating mode for the mobile station. The channel specific parameters are set with commands `SOUR:BB:C2K:MST<n>:CHANnel<n>: . . . n`.

**Parameter: TRAFfic**

The mobile station generates a single traffic channel. A traffic channel consists of up to 8 sub channels depending on the selected radio configuration (R-FCH, R-SCCH, R-SCH, R-DCCH). This mode corresponds to the standard mode of a mobile station during voice and data transmission.

**ACCess**

The mobile station generate an access channel (R-ACH). This channel is needed to set up the connection between the mobile station and the base station.

**EACCess**

The mobile station generates an enhanced access channel (R-ACH) and a pilot channel (R-PICH).

**CCONtrol**

The mobile station generates a common control channel (R-ACH) and a pilot channel (R-PICH).

**Example:**

`"BB:C2K:MST1:MODE TRAF"`

'switches the mobile station into standard mode - voice and data transmission.

*RST value	Resolution	Options	SCPI
TRAFfic	-	B10/B11 and B13 K46 SOURce2 only with second option B9/B10/B11	Device-specific

**[SOURce<[1]|2>:]BB:C2K:MSTation:PRESet**

The command produces a standardized default for all the mobile stations. The settings correspond to the \*RST values specified for the commands. An overview is provided by Table in Chapter 4.

This command triggers an action and therefore has no \*RST value and no query form. The numerical suffix for MSTation has no significance.

**Example:**

`"BB:C2K:MST:PRESet"`

'resets all the mobile station settings to default values.

*RST value	Resolution	Options	Dependencies	SCPI
-	-	B10/B11 and B13 K46 SOURce2 only with second option B9/B10/B11	All mobile station settings are preset.	Device-specific

**[SOURce<[1]|2>:]BB:C2K:MSTation<[1]|2|3|4>:RCONfiguration 1 | 2 | 3 | 4**

The command selects the radio configuration for the traffic channel.

The settings of the channel table parameters are specific for the selected radio configuration.

**Example:** "BB:C2K:MST2:MODE TRAF"  
 'switches mobile station 2 into standard mode - voice and data transmission.

"BB:C2K:MST2:RCON 3"  
 'selects radio configuration 3. With RC3, the traffic channel includes five sub channels.

*RST value	Resolution	Options	Dependencies	SCPI
1	-	B10/B11 and B13 K46 SOURce2 only with second option B9/B10/B11	The R&S Vector Signal Generator provides a separate set of settings of all channel table parameters for each radio configuration. If the radio configuration is changed, the set of channel table values belonging to this RC is automatically activated.	Device-specific

**[SOURce<[1]|2>:]BB:C2K:MSTation<[1]|2|3|4>:STATe ON | OFF**

The command activates and deactivates the specified mobile station.

**Example:** "BB:C2K:MST2:STAT OFF"  
 'deactivates mobile station 2.

*RST value	Resolution	Options	SCPI
OFF	-	B10/B11 and B13 K46 SOURce2 only with second option B9/B10/B11	Device-specific

[SOURce<[1]|2>:]BB:C2K:MSTation<[1]|2|3|4>:TPC:DATA DLIS | ZERO | ONE | PATTErn

The command sets the data source for the power control bits of the traffic channels

**Parameter:** DLIS

A data list is used. The data list is selected with the command  
BB:C2K:MST:TPC:DATA:DSEL

**ZERO | ONE**

Internal 0 and 1 data is used.

**PATTErn**

Internal data is used The bit pattern for the data is defined by the command  
BB:C2K:MST:TPC:DATA:PATTErn. The maximum length is 64 bits.

**Example:**

"BB:C2K:MST2:TPC:DATA PATT"

'selects Pattern data source for the power control bits. The bit pattern is defined with the following command.

"BB:C2K:MST2:TPC:DATA:PATT #H3F,8"

'defines the bit pattern.

*RST value	Resolution	Options	SCPI
ZERO	-	B10/B11 and B13 K46 SOURce2 only with second option B9/B10/B11	Device-specific

[SOURce<[1]|2>:]BB:C2K:MSTation<[1]|2|3|4>:TPC:DATA:DSElect <data list name>

The command selects the data list for the DLIS data source selection.

The lists are stored as files with the fixed file extensions \*.dm\_iqd in a directory of the user's choice. The directory applicable to the following commands is defined with the command MMEMoRY:CDIR. To access the files in this directory, you only have to give the file name, without the path and the file extension.

**Example:**

"BB:C2K:MST2:TPC:DATA DLIS"

'selects the DLIS data source.

"MMEM:CDIR 'D:\Lists\DM\IqData'"

'selects the directory for the data lists.

"BB:C2K:MST2:TPC:DATA:DSEL 'cdma\_ch4'"

"selects the file 'cdma\_ch4' as the data source. This file must be in the directory D:\Lists\DM\IqData and have the file extension \*.dm\_iqd.

*RST value	Resolution	Options	SCPI
-	-	B10/B11 and B13 K46 SOURce2 only with second option B9/B10/B11	Device-specific

[SOURce<[1]|2>:]BB:C2K:MSTation<[1]|2|3|4>:TPC:DATA:PATTern #B0,1 ... #B11..1, 64

The command determines the bit pattern for the PATTern selection. The maximum bit pattern length is 64 bits.

**Example:** "BB:C2K:MST2:TPC:DATA:PATT #H3F, 8"  
'defines the bit pattern for the power control-bits.

*RST value	Resolution	Options	SCPI
#H0,1	-	B10/B11 and B13 K46 SOURce2 only with second option B9/B10/B11	Device-specific

[SOURce<[1]|2>:]BB:C2K:MSTation<[1]|2|3|4>:TPC:MISuse ON | OFF

The command activates/deactivates the use of the power control data for controlling the mobile station output power. In the uplink, the power control bits are used exclusively for controlling the mobile station output power. Power control puncturing is not defined for controlling the base station power.

The bit pattern (see commands :BB:C2K:MSTation<n>:TPC... ) of the power control bits w is used to control the channel power. A "1" leads to an increase of channel powers, a "0" to a reduction of channel powers. Channel power is limited to the range 0 dB to -80 dB. The step width of the change is defined with the command :BB:C2K:MSTation<n>:TPC:PSTep.

**Example:** "BB:C2K:MST2:TPC:MIS ON"  
'activates regulation of channel power for mobile station 2 via the power control bit pattern.

"BB:C2K:MST2:TPC:PST 1 dB"  
'sets the step width for the change of channel powers to 1 dB.

*RST value	Resolution	Options	SCPI
OFF	-	B10/B11 and B13 K46 SOURce2 only with second option B9/B10/B11	Device-specific

[SOURce<[1]|2>:]BB:C2K:MSTation<[1]|2|3|4>:TPC:PSTep -10.0 ... 10.0 dB

The command defines the step width for the change of channel powers in the case of "mis-" use of the power control bits.

**Example:** "BB:C2K:MST2:TPC:PST 0.1 dB"  
'sets the step width for the change of channel powers to 1 dB.

*RST value	Resolution	Options	SCPI
0	0.01 dB	B10/B11 and B13 K46 SOURce2 only with second option B9/B10/B11	Device-specific



**[SOURce<[1]|2>:]BB:C2K:MSTation<[1]|2|3|4>:TPC:READ**

CONTInuous | S0A | S1A | S01A | S10A

The command sets the read out mode for the bit pattern of the power control bits.

The bit pattern is defined with the commands :BB:C2K:MST<n>:TPC . . .

**Parameter:**       **CONTInuous**  
                           The bit pattern is used cyclically.

**S0A**  
                           The bit pattern is used once, then the power control bit sequence continues with 0 bits.

**S1A**  
                           The bit pattern is used once, then the power control bit sequence continues with 1 bits.

**S01A**  
                           The bit pattern is used once and then the power control bit sequence is continued with 0 and 1 bits alternately.

**S10A**  
                           The bit pattern is used once and then the power control bit sequence is continued with 1 and 0 bits alternately.

**Example:**           "BB:C2K:MST2:TPC:READ S0A"  
                           'the bit pattern is used once, after which a 0 sequence is generated (applies to R-DCCH of mobile station 2).

*RST value	Resolution	Options	SCPI
CONTInuous		B10/B11 and B13 K46 SOURce2 only with second option B9/B10/B11	Device-specific

# SOURce:BB:DM Subsystem

## DM General Remote-Control Commands

The commands in the Source:BB:DM subsystem are described in two sections, separated into configuring digital modulation and lists for digital modulation.

The following section contains the commands for generating the digital modulation signal.

The keyword SOURce is optional and can be omitted.

The numeric suffix to SOURce distinguishes between signal generation for path A and path B in the case of two-path instruments:

[SOURce<1>] = path A

SOURce2 = path B

The keyword SOURce is optional in the case of commands for path A and can be omitted. For path B the command must contain the keyword with suffix 2.

Command	Parameter	Default unit	Note
[SOURce<[1] 2>:]BB:DM:ASK:DEPT	0 ... 100	PCT	
[SOURce<[1] 2>:]BB:DM:CLOCK			Query only
[SOURce<[1] 2>:]BB:DM:CLOCK:MODE	SYMBOL   BIT   MSYMBOL		
[SOURce<[1] 2>:]BB:DM:CLOCK:MULTIPLIER	1 ... 64		
[SOURce<[1] 2>:]BB:DM:CLOCK:SOURce	COUPled   INTernal   EXTernal		
[SOURce<[1] 2>:]BB:DM:CODing	OFF   APCO25   APCO25FSK   CDMA2000   DIFF   DPHS   DGRay   EDGE   GRAY   GSM   ICO   NADC   PDC   PHS   TETRA   PWT   TFTS   INmarsat   VDL   WCDMa		
[SOURce<[1] 2>:]BB:DM:FILTer:PARAmeter:APCO25	0.15 ... 2.5		
[SOURce<[1] 2>:]BB:DM:FILTer:PARAmeter:COSSine	0.05 ... 0.99		
[SOURce<[1] 2>:]BB:DM:FILTer:PARAmeter:GAUSSs	0.15 ... 2.5		
[SOURce<[1] 2>:]BB:DM:FILTer:PARAmeter:PGAus	0.15 ... 2.5		
[SOURce<[1] 2>:]BB:DM:FILTer:PARAmeter:RCOSSine	0.05 ... 0.99		
[SOURce<[1] 2>:]BB:DM:FILTer:PARAmeter:SPHase	0.15 ... 2.5		
[SOURce<[1] 2>:]BB:DM:FILTer:TYPE	RCOSSine   COSSine   GAUSSs   LGAuss   CONE   COF705   COEQUALizer   COFEQUALizer   C2K3x   APCO25   SPHase   RECTangle   PGAuss		

Command	Parameter	Default unit	Note
[SOURce<[1]>:]BB:DM:FORMat	ASK   BPSK   P2DBpsk   QPSK   QPSK45   OQPSK   P4QPSk   P4DQpsk   PSK8   P8D8psk   P8EDge   QAM16   QAM32   QAM64   QAM256   QAM1024   MSK   FSK2   FSK4   FSKVar		
[SOURce<[1]>:]BB:DM:FSK:DEVIation	0.1 x Symbol Rate ... 1.5 x Symbol Rate	Hz	
[SOURce<[1]>:]BB:DM:FSK:VARIable:TYPE	4FSK   8FSK   16 FSK		
[SOURce<[1]>:]BB:DM:FSK:VARIable:SYMBOL<0...15>:DEVIation	-1.5 x Symbol Rate ... 1.5 x Symbol Rate (max 10 MHz)	Hz	
[SOURce<[1]>:]BB:DM:MDELay?			Query only
[SOURce<[1]>:]BB:DM:PATTern	#B0 ... #B111...1, 1...64		
[SOURce<[1]>:]BB:DM:PRAMP:ATTenuation	0.0 ... 50	dB	
[SOURce<[1]>:]BB:DM:PRAMP:BBONLY[:STATe]	ON   OFF		
[SOURce<[1]>:]BB:DM:PRAMP:FDELay	-4.0 ... +4.0 symbols		
[SOURce<[1]>:]BB:DM:PRAMP:RDELay	-4.0 ... +4.0 symbols		
[SOURce<[1]>:]BB:DM:PRAMP:SHAPE	LINear   COSine		
[SOURce<[1]>:]BB:DM:PRAMP:SOURce	INTernal   EXTernal		
[SOURce<[1]>:]BB:DM:PRAMP[:STATe]	ON   OFF		
[SOURce<[1]>:]BB:DM:PRAMP:TIME	0.25 ... 32 symbols		
[SOURce<[1]>:]BB:DM:PRBS[:LENGth]	9   11   15   16   20   21   23		
[SOURce<[1]>:]BB:DM:PRESet			
[SOURce<[1]>:]BB:DM:SEQuence	AUTO   RETRigger   AAUTO   ARETrigger   SINGLE		
[SOURce<[1]>:]BB:DM:SOURce	ZERO   ONE   PRBS   PATTern   DLIST   SERIAL   PARAllel   LAN   USB		
[SOURce<[1]>:]BB:DM:SRATe	400 Hz ... 15 MHz (FSK) / 27 MHz	Hz	
[SOURce<[1]>:]BB:DM:STANdard	USER   BLUetooth   CFORward   CREVerse   DECT   ETC   GSM   GSMEdge   NADC   PDC   PHS   TDSCdma   TETRA   TFTS   W3GPP   WORLdspace		
[SOURce<[1]>:]BB:DM:STATe	ON   OFF		
[SOURce<[1]>:]BB:DM:SWITChing:SOURce	INTernal   EXTernal		
[SOURce<[1]>:]BB:DM:SWITChing:STATe	ON   OFF		
[SOURce<[1]>:]BB:DM:TRIGGer:ARM:EXECute	-		No query
[SOURce<[1]>:]BB:DM:TRIGGer:EXECute	-		No query
[SOURce<[1]>:]BB:DM:TRIGGer[:EXTernal<[1]>]:DELay	0 ... 2 <sup>16</sup> - 1 Symbols		
[SOURce<[1]>:]BB:DM:TRIGGer[:EXTernal<[1]>]:INHibit	0 ... 2 <sup>26</sup> - 1 Symbols		
[SOURce<[1]>:]BB:DM:TRIGGer:OBASeband:DELay	0 ... 2 <sup>16</sup> - 1 Symbols		
[SOURce<[1]>:]BB:DM:TRIGGer:OBASeband:INHibit	0 ... 2 <sup>26</sup> - 1 Symbols		
[SOURce<[1]>:]BB:DM:TRIGGer:OUTPut<[1]...4>:DELay	0 ... 2 <sup>20</sup> - 1 Symbols		

Command	Parameter	Default unit	Note
[SOURce<[1] 2>:]BB:DM:TRIGger:OUTPut:DELAy:FIXed	ON   OFF	Hz	
[SOURce<[1] 2>:]BB:DM:TRIGger:OUTPut<[1]...4>:DELAy:MAX?			Query only
[SOURce<[1] 2>:]BB:DM:TRIGger:OUTPut<[1]...4>:DELAy:MIN?			Query only
[SOURce<[1] 2>:]BB:DM:TRIGger:OUTPut<[1]...4>:MODE	CLISt   PULSe   PATTeRn   RATIo		
[SOURce<[1] 2>:]BB:DM:TRIGger:OUTPut<[1]...4>:OFFTime	1 ... (2 <sup>20</sup> - 1) symbols		
[SOURce<[1] 2>:]BB:DM:TRIGger:OUTPut<[1]...4>:ONTime	1 ... (2 <sup>20</sup> - 1) symbols		
[SOURce<[1] 2>:]BB:DM:TRIGger:OUTPut<[1]...4>:PATTeRn	#B0, 1 ... #B111...1,32		
[SOURce<[1] 2>:]BB:DM:TRIGger:OUTPut<[1]...4>:PULSe:DIVider	2 ... 2 <sup>10</sup>		
[SOURce<[1] 2>:]BB:DM:TRIGger:OUTPut<[1]...4>:PULSe:FREQ?			Query only
[SOURce<[1] 2>:]BB:DM:TRIGger:RMODe			Query only
[SOURce<[1] 2>:]BB:DM:TRIGger:SLENgth	1 ... 2 <sup>32</sup> -1 symbols		
[SOURce<[1] 2>:]BB:DM:TRIGger:SOURce	INTernal   EXTernal   BEXTernal   OBASeband		

**[SOURce<[1]|2>:]BB:DM:ASK:DEPT 0 ... 100 PCT**

The command sets the ASK modulation depth when modulation type ASK is selected.

**Example:** "BB:DM:FORM ASK"  
'selects the ASK modulation type.

"BB:DM:ASK:DEPT 50 PCT"  
'sets a modulation depth of 50 percent.

*RST value	Resolution	Options	SCPI
100 PCT	0.1 PCT	B10/B11 and B13 SOURce2 only with second option B9/B10/B11	Device-specific

[SOURce<[1]|2>:]BB:DM:CLOCK:MODE SYMBOL | BIT | MSYMBOL

The command enters the type of externally supplied clock (:BB:DM:CLOCK:SOURce EXTERNAL) . The bit clock and the symbol clock differ only in the case of modulations that have more than two states, i.e. that require more than one bit for encoding each state. When MSYMBOL is used, a multiple of the symbol clock is supplied via the CLOCK connector and the symbol clock is derived internally from this. The multiplier is entered with the command :BB:DM:CLOCK:MULTIPLIER.

With this command the only numerical suffix allowed for SOURce is 1, since the external clock source is permanently allocated to path A.

**Example:** "BB:DM:CLOCK:MODE SYMBOL"  
'selects clock type **Symbols**, i.e. the supplied clock is a symbol clock.

*RST value	Resolution	Options	Dependencies	SCPI
SYMBOL	-	B10/B11 and B13 SOURce2 only with second option B9/B10/B11	It is not possible to select BIT and MSYMBOL in the case of an external serial or external parallel data source (not available) (SOUR:BB:DM:SOUR SER and PAR).	Device-specific

[SOURce<[1]|2>:]BB:DM:CLOCK:MULTIPLIER 1 ... 64

The command specifies the multiplier for clock type **Multiple Symbols** (:BB:DM:CLOCK:MODE MSYM) in the case of an external clock source.

With this command the only numerical suffix allowed for SOURce is 1, since the external clock source is permanently allocated to path A.

**Example:** "BB:DM:CLOCK:SOUR EXT"  
'selects the external clock source. The clock is supplied via the CLOCK connector.

"BB:DM:CLOCK:MODE MSYM"  
'selects clock type **Multiple Symbols**, i.e. the supplied clock has a rate which is a multiple of the symbol rate.

"BB:DM:CLOCK:MULT 12"  
'the multiplier for the external clock rate is 12.

*RST value	Resolution	Options	SCPI
4	1	B10/B11 and B13 SOURce2 only with second option B9/B10/B11	Device-specific

[SOURce<[1]|2>:]BB:DM:CLOCK:SOURce COUPled | INTernal | EXTernal

The command selects the source for the digital modulation clock.

Selecting COUPled and EXTernal is only possible for path A, since the external clock source is permanently allocated to path A.

**Parameter: IINTernal**  
The internal clock reference is used.

**EXTernal**  
The external clock reference is supplied to the CLOCK connector.

**COUPled**  
The clock reference (internal or external) is selected automatically according to the selected data source.

**Example:** "BB:DM:CLOC:SOUR INT"  
'selects the internal clock reference.

*RST value	Resolution	Options	Dependencies	SCPI
INTernal	-	B10/B11 and B13 SOURce2 only with second option B9/B10/B11	When COUPled is selected and the data source is changed (:BB:DM:DATA:SOUR) the clock source is automatically changed correspondingly as well	Device-specific

[SOURce<[1]|2>:]BB:DM:CODing OFF| APCO25 | APCO25FSK | CDMA2000 | DIFF| DPHS| DGRay | EDGE | GRAY| GSM| ICO| NADC| PDC| PHS| TETRa | PWT| TFTS| INMarsat | VDL | WCDMa

The command selects the modulation coding.

**Parameter: DPHS**  
Phase Difference

**DGRay**  
Difference + Gray

...

**Example:** "BB:DM:COD GRAY"  
'selects GRAY coding. This coding is valid for all modulation types.

*RST value	Resolution	Options	Dependencies	SCPI
INTernal	-	B10/B11 and B13 SOURce2 only with second option B9/B10/B11	If the modulation type selected (:BB:DM:FORM) is not possible with the coding that has been set, it is automatically set to OFF (:BB:DM:COD OFF). When a standard is selected (:BB:DM:STAN), the coding is set to the default value.	Instrument-specific

**[SOURce<[1]>:]BB:DM:FILTer:PARAmeter:APCO25 0.05 ... 0.99**

The command sets the roll-off factor for filter type APCO25.

**Example:** "BB:DM:FILT:PAR:APCO25 0.2"  
'sets the roll-off factor to 0.2 for filter type APCO25.

*RST value	Resolution	Options	Dependencies	SCPI
0.20	0.01	B10/B11 and B13 SOURce2 only with second option B9/B10/B11	On selecting filter APCO25, the filter parameter is set to the default value.	Device-specific

**[SOURce<[1]>:]BB:DM:FILTer:PARAmeter:COSSine 0.05 ... 0.99**

The command sets the roll-off factor for the Cosine filter type.

**Example:** "BB:DM:FILT:PAR:COSS 0.35"  
'sets the roll-off factor to 0.35 for filter type Cosine.

*RST value	Resolution	Options	Dependencies	SCPI
0.35	0.01	B10/B11 and B13 SOURce2 only with second option B9/B10/B11	On selecting the Cosine filter , the filter parameter is set to the default value.	Device-specific

**[SOURce<[1]>:]BB:DM:FILTer:PARAmeter:GAUSS 0.15 ... 2.5**

The command sets the roll-off factor for the Gauss filter type.

**Example:** "BB:DM:FILT:PAR:GAUSS 0.5"  
'sets B x T to 0.5 for the Gauss filter type.

*RST value	Resolution	Options	Dependencies	SCPI
0.3	0.01	B10/B11 and B13 SOURce2 only with second option B9/B10/B11	On selecting the GAUSS filter or a standard (:BB:DM:STAN) which uses the GAUSS filter, the filter parameter is set to the default value.	Device-specific

**[SOURce<[1]>:]BB:DM:FILTer:PARAmeter:PGAuss 0.15 ... 2.5**

The command sets the roll-off factor for the Pure Gauss filter type.

**Example:** "BB:DM:FILT:PAR:PGA 0.5"  
'sets B x T to 0.5 for the Pure Gauss filter type.

*RST value	Resolution	Options	Dependencies	SCPI
0.5	0.01	B10/B11 and B13 SOURce2 only with second option B9/B10/B11	On selecting the Pure GAUSS filter the filter parameter is set to the default value.	Device-specific

[SOURce<[1]>:]BB:DM:FILTer:PARAmeter:RCOSine 0.05 ... 0.99

The command sets the roll-off factor for the Root Cosine filter type.

**Example:** "BB:DM:FILT:PAR:RCOS 0.22"  
'sets the roll-off factor to 0.22 for filter type Root Cosine.

*RST value	Resolution	Options	Dependencies	SCPI
0.35	0.01	B10/B11 and B13 SOURce2 only with second option B9/B10/B11	On selecting the Root Cosine filter or a standard (:BB:DM:STAN) which uses the Root Cosine filter, the filter parameter is set to the default value.	Device-specific

[SOURce<[1]>:]BB:DM:FILTer:PARAmeter:SPHase 0.15 ... 2.5

The command sets B x T for the Split Phase filter type.

**Example:** "BB:DM:FILT:PAR:SPH 0.5"  
'sets B x T to 0.5 for the Split Phase filter type.

*RST value	Resolution	Options	Dependencies	SCPI
0.35	0.01	B10/B11 and B13 SOURce2 only with second option B9/B10/B11	On selecting the Split Phase filter or a standard (:BB:DM:STAN) which uses the Split Phase filter, the filter parameter is set to the default value.	Device-specific

[SOURce<[1]>:]BB:DM:FILTer:TYPE RCOSine | COSine | GAUSSs | LGAuss | CONE | COF705 | COEqualizer | COFequalizer | C2K3x | APCO25 | SPHase | RECTangle | PGAuss

The command selects the filter type.

**Example:** "BB:DM:FILT:TYPE COS"  
'selects the Cosine filter type.

*RST value	Resolution	Options	Dependencies	SCPI
GAUSSs	-	B10/B11 and B13 SOURce2 only with second option B9/B10/B11	When a standard is selected (:BB:DM:STAN), the filter type and filter parameter are set to the default value.	Device-specific



[SOURce<[1]|2>:]BB:DM:FORMat ASK | BPSK | QPSK | QPSK45 | OQPSk | P4QPsK | P2DBpsk | P4DQpsk | P8D8psk | PSK8 | P8EDge | QAM16 | QAM32 | QAM64 | QAM256 | QAM1024 | MSK | FSK2 | FSK4 | FSKVar

The command selects the modulation type.

**Example:** "BB:DM:FORM QPSK"  
'selects modulation type QPSK.

*RST value	Resolution	Options	Dependencies	SCPI
MSK	-	B10/B11 and B13 SOURce2 only with second option B9/B10/B11	If the coding that is set (:BB:DM:COD) is not possible with the modulation type selected, it is automatically set to OFF (:BB:DM:COD OFF). When a standard is selected (:DM:STAN), the modulation type is set to the default value.	Device-specific

[SOURce<[1]|2>:]BB:DM:FSK:DEVIation <numeric\_value>

The command sets the frequency deviation when FSK modulation is selected. The range of values depends on the symbol rate that is set (see data sheet) and the maximum deviation is 10 MHz.

**Example:** "BB:DM:FORM FSK"  
'selects FSK modulation.  
"BB:DM:FSK:DEV 10 MHz"  
'sets the frequency deviation to 10 MHz.

*RST value	Resolution	Options	Dependencies	SCPI
Symbol rate/2	0.5 Hz	B10/B11 and B13 SOURce2 only with second option B9/B10/B11	If the symbol rate that is set exceeds the maximum possible value for the chosen frequency deviation, it is suitably adapted (:BB:DM:SRAT).	Device-specific

[SOURce<[1]|2>:]BB:DM:FSK:VARiable:SYMBOL<0...15>:DEVIation <numeric\_value>

The command sets the deviation of the selected symbol for variable FSK modulation mode. The number of symbols (and therefore the suffix range) depends on the selected FSK modulation type. The range of values depends on the symbol rate that is set (see data sheet) and the maximum deviation is 10 MHz.

**Example:** "BB:DM:FORM FSKV"  
'selects Variable FSK modulation.  
"BB:DM:FSK:VAR:TYPE FSK16"  
'selects 16FSK modulation.  
"BB:DM:FSK:VAR:SYMB0:DEV 135000"  
'sets the frequency deviation of the least significant symbol to 135 kHz.

*RST value	Resolution	Options	SCPI
-	0.5 Hz	B10/B11 and B13 SOURce2 only with second option B9/B10/B11	Device-specific

[SOURce<[1]>:]BB:DM:FSK:VARiable:TYPE FSK4 | FSK8 | FSK16

The command selects the modulation type for Variable FSK.

**Example:** "BB:DM:FORM FSKV"  
'selects Variable FSK modulation.  
  
"BB:DM:FSK:VAR:TYPE FSK16"  
'selects 16FSK modulation.

*RST value	Resolution	Options	SCPI
-	-	B10/B11 and B13 SOURce2 only with second option B9/B10/B11	Device-specific

[SOURce<[1]>:]BB:DM:MDELay?

The command queries the digital modulation delay from the data input to the I/Q output in the case of external modulation.

This command is a query and therefore has no \*RST value.

**Example:** "BB:DM:MDEL?"  
'queries the delay in the case of external modulation.

*RST value	Resolution	Options	SCPI
-	-	B10/B11 and B13 SOURce2 only with second option B9/B10/B11	Device-specific

[SOURce<[1]>:]BB:DM:PATTern #B0 ... #B11...1, 1...64

The command selects the data pattern for the internal data when PATTern is selected as the data source. The maximum length is 64 bits.

**Example:** "BB:DM:SOUR PATT"  
'selects Pattern as the data source for digital modulation.  
  
"BB:DM:PATT #B01110111010101010,17"  
'generates the user-defined sequence of 0/1 data.

*RST value	Resolution	Options	SCPI
#B0,1	-	B10/B11 and B13 SOURce2 only with second option B9/B10/B11	Device-specific

[SOURce<[1]>:]BB:DM:PRAMP:ATTenuation 0.0 ... 70 dB

The command sets the level attenuation for signal ranges that are flagged with level attribute **attenuated** by the LEV\_ATT control signal.

**Example:** "BB:DM:PRAM:ATT 15 dB"  
'sets a level attenuation of 15 dB.

*RST value	Resolution	Options	SCPI
15 dB	0.01 dB	B10/B11 and B13 SOURce2 only with second option B9/B10/B11	Device-specific

**[SOURce<[1]|2>:]BB:DM:PRAMP:BBONly[:STATe] ON | OFF**

This command selects power ramping in the baseband only or mixed power ramping in the baseband and the RF section. The **ON** setting is mandatory if, with power ramping active, only the baseband signal is output (I/Q outputs), or if a baseband signal is applied to two RF paths (RF A and RF B).

Only then can a signal with a defined, predictable level be output.

**Example:** "BB:DM:PRAMP:BBON ON"  
'selects power ramping in the baseband only.

*RST value	Resolution	Options	SCPI
OFF		B10/B11 and B13 SOURce2 only with second option B9/B10/B11	Device-specific

**[SOURce<[1]|2>:]BB:DM:PRAMP:FDElay - 4.0 ... + 4.0 Symbols**

The command sets the delay in the falling edge. A positive value gives rise to a delay and a negative value causes an advance. The setting is expressed in symbols.

**Example:** "BB:DM:PRAMP:FDEL 1"  
'the falling edge starts 1 symbol later.

*RST value	Resolution	Options	SCPI
0 symbols	0.1 symbol	B10/B11 and B13 SOURce2 only with second option B9/B10/B11	Device-specific

**[SOURce<[1]|2>:]BB:DM:PRAMP:RDElay - 4.0 ... + 4.0 Symbols**

The command sets the delay in the rising edge. A positive value gives rise to a delay and a negative value causes an advance. The setting is expressed in symbols.

**Example:** "BB:DM:PRAMP:RDEL 1"  
'the rising edge starts 1 symbol later.

*RST value	Resolution	Options	SCPI
0 symbols	0.1 symbol	B10/B11 and B13 SOURce2 only with second option B9/B10/B11	Device-specific

**[SOURce<[1]|2>:]BB:DM:PRAMP:SHAPE LINear | COSine**

The command sets the edge shape of the ramp envelope.

**Example:** "BB:DM:PRAMP:SHAP COS"  
'selects a cosine-shaped rise and fall for the transmitted power edge.

*RST value	Resolution	Options	SCPI
COSine	-	B10/B11 and B13 SOURce2 only with second option B9/B10/B11	Device-specific

**[SOURce<[1]|2>:]BB:DM:PRAMP:SOURce INTernal | EXTernal**

The command sets the source for the power ramp control signals.

**Parameter:**       **INTernal**  
                           'the internal control signals LEV\_ATT and BURST are used. Control signals are stored in dedicated lists. When remote control is in use, the list to be used is selected and enabled with the aid of `SOURce:BB:DM:CLIST:...` commands.

**EXTernal**  
                           'the digital control signals LEV\_ATT and BURST are supplied via the control signal inputs on the AUX I/O connector.

**Example:**        "`BB:DM:PRAM:SOUR EXT`"  
                           'enables the use of external control signals for power ramp control. The signals must be supplied via the AUX I/O interface.

*RST value	Resolution	Options	SCPI
INTernal	-	B10/B11 and B13 SOURce2 only with second option B9/B10/B11	Device-specific

**[SOURce<[1]|2>:]BB:DM:PRAMP[::STATe] ON | OFF**

The command enables or disables power ramping.

**Example:**        "`BB:DM:PRAM:STAT ON`"  
                           'switches power ramping on.

*RST value	Resolution	Options	SCPI
OFF		B10/B11 and B13 SOURce2 only with second option B9/B10/B11	Device-specific

**[SOURce<[1]|2>:]BB:DM:PRAMP:TIME 0.25 ... 16 Symbols**

The command sets the power ramping rise time and fall time for a burst.

**Example:**        "`BB:DM:PRAM:TIME 2`"  
                           'sets a time of 2 symbols for the edges to rise and fall.

*RST value	Resolution	Options	SCPI
1 symbol	0.1 symbol	B10/B11 and B13 SOURce2 only with second option B9/B10/B11	Device-specific

[SOURce<[1]|2>:]BB:DM:PRBS[:LENGth] 9 | 11 | 15 | 16 | 20 | 21 | 23

The command defines the length of the pseudo-random sequence in accordance with the following equation:

$$\text{Length} = (2^{\text{LENGth}}) - 1$$

**Example:** "BB:DM:SOUR PRBS"  
 'the internal pseudo-random generator is used as the data source.  
 "BB:DM:PRBS 9"  
 'an internal pseudo-random sequence of 511 bits will be generated.

*RST value	Resolution	Options	SCPI
9	-	B10/B11 and B13 SOURce2 only with second option B9/B10/B11	Device-specific

[SOURce<[1]|2>:]BB:DM:PRESet

The command calls the default settings for digital modulation.

The command triggers an action and therefore has no \*RST value and no query form.

**Example:** "BB:DM:PRESet"  
 'calls the default settings for DM.

*RST value	Options	Dependencies	SCPI
-	B10/B11 and B13 SOURce2 only with second option B9/B10/B11	:BB:DM:CLOC:DEL 0 :BB:DM:CLOC:MODE SYMB :BB:DM:CLOC:SOUR INT :BB:DM:CLOC:COD GSM :BB:DM:FILT:PAR:APC 0.2 :BB:DM:FILT:PAR:COS 0.35 :BB:DM:FILT:PAR:GAUS 0.5 :BB:DM:FILT:PAR:RCOS 0.22 :BB:DM:FILT:PAR:SPH 0.1 :BB:DM:FILT:TYPE RCOS :BB:DM:FORM MSK :BB:DM:FSK:DEV 135.417kHz :BB:DM:PATT #H0,1 :BB:DM:PRAM:ATT 15 dB :BB:DM:PRAM:ROFF 0 :BB:DM:PRAM:FOFF 0 :BB:DM:PRAM:SHAP COS :BB:DM:PRAM:SOUR INT :BB:DM:PRAM OFF :BB:DM:PRAM:TIME 1 Symb :BB:DM:PRBS 9 :BB:DM:SEQ AUTO :BB:DM:SOUR PRBS :BB:DM:SRAT 270.833 kHz :BB:DM:STAN GSM :BB:DM:TRIG:DEL 0 :BB:DM:TRIG:INH 0 :BB:DM:TRIG:OUTP:DEL 0 :BB:DM:TRIG:OUTP:MODE FRAM :BB:DM:TRIG:OUTP:PER 1 :BB:DM:TRIG:SOUR INT	Device-specific

**[SOURce<[1]>:]BB:DM:SEQuence** AUTO | RETRigger | AAUTo | ARETrigger | SINGle

The command selects the trigger mode.

**Parameter: AUTO**

The modulation signal is generated continuously.

**RETRigger**

The modulation signal is generated continuously. A trigger event (internal or external) causes a restart.

**AAUTo**

The modulation signal is generated only when a trigger event occurs. After the trigger event the signal is generated continuously. Signal generation is stopped with command `SOUR:BB:DM:TRIG:ARM:EXEC` and started again when a trigger event occurs.

**ARETrigger**

The modulation signal is generated only when a trigger event occurs. The device automatically toggles to RETRIG mode. Every subsequent trigger event causes a restart. Signal generation is stopped with command `SOUR:BB:DM:TRIG:ARM:EXEC` and started again when a trigger event occurs.

**SINGle**

The modulation signal is generated only when a trigger event occurs. After the trigger event the signal is generated once to the set sequence length (`SOUR:BB:DM:TRIG:SLEN`). Every subsequent trigger event causes a restart.

**Example:**

`"BB:DM:SEQ AAUT"`

'sets the **Armed\_auto** trigger mode; the device waits for the first trigger (e.g. with `*TRG`) and then generates the signal continuously.

*RST value	Resolution	Options	SCPI
AUTO	-	B10/B11 and B13 SOURce2 only with second option B9/B10/B11	Device-specific

[SOURce<[1]|2>:]BB:DM:SOURce ZERO | ONE | PRBS | PATtern | DLIS | SERial | PARallel

The command selects the data source.

**Parameter:** ZERO

An internally generated 0 data sequence is used.

**ONE**

An internally generated 1 data sequence is used.

**PRBS**

The pseudo-random sequence generator is used as the data source. The length of the random sequence is defined with the aid of command SOURce:BB:DM:PRBS.

**PATtern**

Internally generated data with a fixed pattern is used. The data pattern is defined using command SOURce:BB:DM:PATtern.

**DLIS**

Data from the selected data list is used.

**SERial**

External data from the serial interface is used (path A).

**PARallel**

External data from the parallel interface is used (path A).

**Example:**

"BB:DM:SOUR DLIS"  
'the internal data generator is used.

"BB:DM:DLIS:SEL 'test'"  
'the data list 'test.dm\_iqd' is used.

*RST value	Resolution	Options	SCPI
PRBS	-	B10/B11 and B13 SOURce2 only with second option B9/B10/B11	Device-specific

[SOURce<[1]|2>:]BB:DM:SRATe 400 Hz ... 15 MHz (FSK) / 25 MHz

The command sets the symbol rate. The value range is dependent on the selected modulation type. On changing to an FSK modulation type, excessively high values are automatically limited to the maximum value that can be set for FSK (see data sheet). The symbol rate can be entered in Hz/kHz/MHz or Symb/s / kSymb/s and MSymb/s.

When a standard is selected (DM:STANdard), the symbol rate is automatically set to the appropriate default value.

**Example:**

"BB:DM:SRAT 10 MHz"  
'sets a symbol rate of 10 MHz.

*RST value	Resolution	Options	Dependencies	SCPI
270.833 kHz	0.001 Hz	B10/B11 and B13 SOURce2 only with second option B9/B10/B11	The value range is dependent on the selected modulation type (:BB:DM:FORM). When a standard is selected (:BB:DM:STAN), the symbol rate is set to the default value.	Device-specific

[SOURce<[1]>:]BB:DM:STANdard USER | BLUetooth | CFORward | CREVerse | DECT | ETC | GSM | GSMEdge | NADC | PDC | PHS | TDSCdma | TETRa | TFTS | W3GPP | WORLdspace

The command selects the standard. After selection, modulation parameters **Modulation Type**, **Symbol Rate**, **Filter** and **Coding** are automatically set in accordance with the standard. The USER parameter cannot be set. A query returns this value if a user-defined Custom Dig Mod setting was loaded or if one of the associated settings was changed subsequent to the selection of a standard. The user defined settings are stored and loaded with commands :BB:DM:STAN:ULIS:... (see following section "[DM Lists - Remote-Control Commands](#)").

**Example:** "BB:DM:STAN DECT"  
'selects digital modulation according to the DECT standard.

*RST value	Resolution	Options	Dependency	SCPI
GSM	-	B10/B11 and B13 SOURce2 only with second option B9/B10/B11	Each selection sets the parameters :BB:DM:FORMat :BB:DM:SRATe :BB:DM:FILTer:TYPE :BB:DM:FILTer:PARAmeter:... :BB:DM:CODing and if necessary :BB:DM:FSK:DEV to the appropriate default values.	Device-specific

[SOURce<[1]>:]BB:DM:STATe ON | OFF

The command enables or disables digital modulation. Switching on digital modulation turns off all the other digital standards on the same path (SOURce1 or SOURce2).

**Example:** "BB:DM:STAT ON"  
'switches digital modulation on.

*RST value	Resolution	Options	Dependency	SCPI
OFF	-	B10/B11 and B13 SOURce2 only with second option B9/B10/B11	:BB:DM:STAT ON turns off all the other standards on the same path".	Device-specific

[SOURce<[1]>:]BB:DM:SWITChing:SOURce INTernal | EXTernal

The command selects the source of the CW control signal for switching between a modulated and an unmodulated RF signal.

**Parameter:** **INTernal**  
The CW signal in the control list is used for the control. The internal signal can be output on one of the user interfaces.

**EXTernal**  
The control signal on the CW pin of the AUX I/Q connector is used (path A and B).

**Example:** "BB:DM:SWIT INT"  
'the CW signal in the control list is used for the control.

*RST value	Resolution	Options	SCPI
INTernal	-	B10/B11 and B13 SOURce2 only with second option B9/B10/B11	Device-specific



[SOURce<[1]|2>:]BB:DM:SWITching:STATe ON | OFF

The command enables switching between a modulated and an unmodulated RF signal.

**Example:** "BB:DM:SWIT:STAT INT"  
'CW switching is active.

*RST value	Resolution	Options	SCPI
OFF	-	B10/B11 and B13 SOURce2 only with second option B9/B10/B11	Device-specific

[SOURce<[1]|2>:]BB:DM:TRIGger:ARM:EXECute

The command stops signal generation for trigger modes Armed\_Auto and Armed\_Retrigger. A subsequent internal or external trigger event restart signal generation.

This command triggers an event and therefore has no \*RST value and no query form.

**Example:** "BB:DM:TRIG:SOUR INT"  
'sets internal triggering.  
"BB:DM:TRIG:SEQ ARET"  
'sets Armed\_Retrigger mode, i.e. every trigger event causes signal generation to restart.  
"BB:DM:TRIG:EXEC"  
'executes a trigger, signal generation is started.  
"BB:DM:TRIG:ARM:EXEC"  
'signal generation is stopped.  
"BB:DM:TRIG:EXEC"  
'executes a trigger, signal generation is started again.

*RST value	Resolution	Options	SCPI
-	1	B10/B11 and B13 SOURce2 only with second option B9/B10/B11	Device-specific

[SOURce<[1]|2>:]BB:DM:TRIGger:EXECute

The command executes a trigger. The internal trigger source must be selected using the command :BB:DM:TRIG:SOUR INT and a trigger mode other than AUTO must be selected using the command :BB:DM:TRIG:SEQ.

This command triggers an event and therefore has no \*RST value and no query form.

**Example:** "BB:DM:TRIG:SOUR INT"  
'sets internal triggering.  
"BB:DM:TRIG:SEQ RETR"  
'sets Retrigger mode, i.e. every trigger event causes signal generation to restart.  
"BB:DM:TRIG:EXEC"  
'executes a trigger.

*RST value	Resolution	Options	SCPI
-	1	B10/B11 and B13 SOURce2 only with second option B9/B10/B11	Device-specific

**[SOURce<[1]|2>:]BB:DM:TRIGger[:EXTErnal<[1]|2>]:DELay 0 ... 2<sup>16</sup>-1 Symbols**

The command specifies the trigger delay (expressed as a number of symbols) for external triggering. The numeric suffix to EXTErnal distinguishes between the external trigger via the TRIGGER 1 (suffix 1) and TRIGGER 2 (suffix 2) connector.

**Example:** "BB:DM:TRIG:SOUR EXT"  
'selects an external trigger via the TRIGGER 1 connector.  
"BB:DM:TRIG:DEL 50"  
'sets a delay of 50 symbols for the trigger.

*RST value	Resolution	Options	SCPI
0 symbols	1 symbol for :BB:DM:CLOC:SOUR EXT  0.01 symbols for :BB:DM:CLOC:SOUR INT	B10/B11 and B13 SOURce2 only with second option B9/B10/B11	Device-specific

**[SOURce<[1]|2>:]BB:DM:TRIGger[:EXTErnal<[1]|2>]:INHibit 0 ... 2<sup>26</sup>-1 Symbols**

The command specifies the number of symbols by which a restart is to be inhibited following a trigger event. This command applies only in the case of external triggering. The numeric suffix to EXTErnal distinguishes between the external trigger via the TRIGGER 1 (suffix 1) and TRIGGER 2 (suffix 2) connector.

**Example:** "BB:DM:TRIG:SOUR EXT"  
'selects an external trigger via the TRIGGER 1 connector.  
"BB:DM:TRIG:INH 200"  
'sets a restart inhibit for 200 symbols following a trigger event.

*RST value	Resolution	Options	SCPI
0 symbols	1 symbol	B10/B11 and B13 SOURce2 only with second option B9/B10/B11	Device-specific

**[SOURce<[1]|2>:]BB:DM:TRIGger:OBASeband:DELay 0 ... 2<sup>16</sup>-1 Symbols**

The command specifies the trigger delay (expressed as a number of symbols) for triggering by the trigger signal from the second path (two-path instruments only).

**Example:** "BB:DM:TRIG:SOUR OBAS"  
'sets for path A the internal trigger executed by the trigger signal from the second path (path B).  
"BB:DM:TRIG:OBAS:DEL 50"  
sets a delay of 50 symbols for the trigger.

*RST value	Resolution	Options	SCPI
0 symbols	1 symbol for :BB:DM:CLOC:SOUR EXT  0.01 symbols for :BB:DM:CLOC:SOUR INT	B10/B11 and B13 SOURce2 only with second option B9/B10/B11	Device-specific

**[SOURce<[1]|2>:]BB:DM:TRIGger:OBASeband:INHibit 0 ... 2<sup>26</sup>-1 Symbols**

The command specifies the number of symbols by which a restart is to be inhibited following a trigger event. This command applies only for triggering by the second path (two-path instruments only).

**Example:**           "BB:DM:TRIG:SOUR OBAS"  
                          'sets for path A the internal trigger executed by the trigger signal from the second path (path B).

"BB:DM:TRIG:INH 200"  
                          'sets a restart inhibit for 200 symbols following a trigger event.

*RST value	Resolution	Options	SCPI
0 symbols	1 symbol	B10/B11 and B13 SOURce2 only with second option B9/B10/B11	Device-specific

**[SOURce<[1]|2>:]BB:DM:TRIGger:OUTPut<[1]...4>:DELay 0 ... 100 000 Symbols**

The command defines the delay between the signal on the marker outputs and the start of the signal, expressed in terms of symbols. Command :BB:DM:TRIGger:OUTPut:DELay:FIXed can be used to restrict the range of values to the dynamic range, i.e. the range within which a delay of the marker signals can be set without restarting the marker and signal.

**Example:**           "BB:DM:TRIG:OUTP2:DEL 16"  
                          'sets a delay of 16 symbols for the signal on connector MARKER 2.

*RST value	Resolution	Options	SCPI
0 symbols	1 symbol	B10/B11 and B13 SOURce2 only with second option B9/B10/B11	Device-specific

**[SOURce<[1]|2>:]BB:DM:TRIGger:OUTPut:DELay:FIXed ON | OFF**

The command restricts the marker delay setting range to the dynamic range. In this range the delay can be set without restarting the marker and signal. If a delay is entered in setting ON but is outside this range, the maximum possible delay is set and an error message is generated.

The numeric suffix in OUTPut has no significance for this command, since the setting always affects every marker.

**Example:**           "BB:DM:TRIG:OUTP:DEL:FIX ON"  
                          'restricts the marker signal delay setting range to the dynamic range.

*RST value	Resolution	Options	SCPI
OFF	-	B10/B11 and B13 SOURce2 only with second option B9/B10/B11	Device-specific

**[SOURce<[1]>:]BB:DM:TRIGger:OUTPut<[1]...4>:DELay:MAXimum**

The command queries the maximum marker delay for setting :BB:DM:TRIG:OUTP:DEL:FIX ON.

The command is a query only and therefore has no \*RST value.

**Example:** "BB:DM:TRIG:OUTP:DEL:FIX ON"  
 'restricts the marker signal delay setting range to the dynamic range.

"BB:DM:TRIG:OUTP:DEL:MAX"  
 'queries the maximum of the dynamic range.

Response: "2000"  
 'the maximum for the marker delay setting is 2000 symbols.

*RST value	Resolution	Options	SCPI
-	-	B10/B11 and B13 SOURce2 only with second option B9/B10/B11	Device-specific

**[SOURce<[1]>:]BB:DM:TRIGger:OUTPut<[1]...4>:DELay:MINimum**

The command queries the minimum marker delay for setting :BB:DM:TRIGger:OUTPut:DELay:FIXed ON.

The command is a query only and therefore has no \*RST value.

**Example:** "BB:DM:TRIG:OUTP:DEL:FIX ON"  
 'restricts the marker signal delay setting range to the dynamic range.

"BB:DM:TRIG:OUTP:DEL:MIN"  
 'queries the minimum of the dynamic range.

Response: "0"  
 'the minimum for the marker delay setting is 0 symbols.

*RST value	Resolution	Options	SCPI
-	-	B10/B11 and B13 SOURce2 only with second option B9/B10/B11	Device-specific

**[SOURce<[1]|2>:]BB:DM:TRIGger:OUTPut<[1]...4>:MODE** CLISt | PULSe | PATTern | RATio

The command defines the signal for the selected marker output.

- Parameter:**      **CLISt**  
                          A marker signal that is defined in the selected control list is generated.
- PULSe**  
                          A pulsed marker signal is generated. The pulse frequency  
                          (= symbol rate/divider) is defined with the  
                          SOUR:BB:DM:TRIG:OUTP:PULSe:DIVider command and can be queried  
                          with the SOUR:BB:DM:TRIG:OUTP:PULSe:FREQuency? command.
- PATTern**  
                          A marker signal is generated with the aid of a user-definable bit pattern. The  
                          bit pattern is entered with the aid of command  
                          SOURce:BB:DM:TRIGger:OUTPut:PATTern . The bit pattern is a  
                          maximum of 32 bits long.
- RATio**  
                          A regular marker signal corresponding to the Time Off / Time On  
                          specifications in the commands SOURce:BB:DM:TRIGger:OUTPut:OFFT  
                          and SOURce:BB:DM:TRIGger:OUTPut:ONT is generated.

**Example:**            "BB:DM:TRIG:OUTP2:MODE PULS"  
                          'selects the pulsed marker signal on output MARKER 2.

*RST value	Resolution	Options	SCPI
RATio	-	B10/B11 and B13 SOURce2 only with second option B9/B10/B11	Device-specific

**[SOURce<[1]|2>:]BB:DM:TRIGger:OUTPut<[1]...4>:OFFTime** 1 ... 2<sup>20</sup> -1 symbol

The command sets the number of symbols in a period (ON time + OFF time) during which the marker signal in setting SOURce:BB:DM:TRIGger:OUTPut:MODE RATio on the marker outputs is OFF.

**Example:**            "BB:DM:TRIG:OUTP2:OFFT 20"  
                          'sets an OFF time of 20 symbols for marker signal 2 on path A.

*RST value	Resolution	Options	SCPI
1	1	B10/B11 and B13 SOURce2 only with second option B9/B10/B11	Device-specific

**[SOURce<[1]|2>:]BB:DM:TRIGger:OUTPut<[1]...4>:ONTime 1 ... 2^20 -1 symbol**

The command sets the number of symbols in a period (ON time + OFF time) during which the marker signal in setting SOURce:BB:DM:TRIGger:OUTPut:MODE RATIO on the marker outputs is ON.

**Example:** "BB:DM:TRIG:OUTP2:ONT 20"  
'sets an ON time of 20 symbols for marker 2 on path A.

*RST value	Resolution	Options	SCPI
1	1	B10/B11 and B13 SOURce2 only with second option B9/B10/B11	Device-specific

**[SOURce<[1]|2>:]BB:DM:TRIGger:OUTPut<[1]...4>:PATTern #B0,1 ... #B111...1, 2**

The command defines the bit pattern used to generate the marker signal in the setting SOURce:BB:DM:TRIGger:OUTPut:MODE PATTern. 0 is marker off, 1 is marker on

**Example:** "BB:DM:TRIG:OUTP2:PATT #B000000011111111,15"  
'sets a bit pattern.

"BB:DM:TRIG:OUTP2:MODE PATT"  
'activates the marker signal according to a bit pattern on output MARKER 2.

*RST value	Resolution	Options	SCPI
#B,1	-	B10/B11 and B13 SOURce2 only with second option B9/B10/B11	Device-specific

**[SOURce<[1]|2>:]BB:DM:TRIGger:OUTPut<[1]...4>:PULSe:DIVider 2 ... 2^10**

The command sets the divider for Pulse marker mode (SOUR:BB:DM:TRIGr:OUTP:MODE PULSE.). The resulting pulse frequency is derived by dividing the symbol rate by the divider.

**Example:** "BB:DM:TRIG:OUTP2:PULS:DIV 2"  
'sets the divider to 2 for the path A marker signal on output MARKER 2.

"BB:DM:TRIG:OUTP2:FREQ?"  
'queries the resulting pulse frequency of the marker signal.

Response: "66 000"  
'the resulting pulse frequency is 66 kHz.

*RST value	Resolution	Options	SCPI
2	1	B10/B11 and B13 SOURce2 only with second option B9/B10/B11	Device-specific

**[SOURce<[1]|2>:]BB:DM:TRIGger:OUTPut<[1]...4>:PULSe:FREQuency?**

The command queries the pulse frequency of the pulsed marker signal in the setting SOURce:BB:DM:TRIGger:OUTPut:MODE PULSe. The pulse frequency is derived by dividing the symbol rate by the divider.

The command is a query command and therefore has no \*RST value.

**Example:** "BB:DM:TRIG:OUTP2:PULS:DIV 2"  
 'sets the divider for the path A marker signal on output MARKER 2 to the value 2.

"BB:DM:TRIG:OUTP2:MODE PULS"  
 'enables the pulsed marker signal.

"BB:DM:TRIG:OUTP2:PULS:FREQ?"  
 'queries the pulse frequency of the marker signal.

Response: "33 000"  
 'the resulting pulse frequency is 33 kHz.

*RST value	Resolution	Options	SCPI
-	-	B10/B11 and B13 SOURce2 only with second option B9/B10/B11	Device-specific

**[SOURce<[1]|2>:]BB:DM:TRIGger:RMODE**

The command displays the status of signal generation for all trigger modes with digital modulation on.

The command is a query command and therefore has no \*RST value.

**Parameter:** **RUN**  
 the signal is generated. A trigger event occurred in the triggered mode.

**STOP**  
 the signal is not generated. A trigger event did not occur in the triggered modes, or signal generation was stopped by the command  
 :BB:DM:TRIG:ARM:EXECute (armed trigger modes only).

**Example:** "SOUR2:BB:DM:TRIG:SOUR EXT"  
 'sets external triggering via the TRIGGER 1 connector for path B of a two-path instrument.

"SOUR2:BB:DM:TRIG:MODE ARET"  
 'selects the Armed\_Retrigger mode.

"SOUR2:BB:DM:TRIG:RMODE?"  
 'queries the current status of signal generation.

Response: "RUN"  
 'the signal is generated, an external trigger was executed.

*RST value	Resolution	Options	SCPI
-	-	B10/B11 and B13 SOURce2 only with second option B9/B10/B11	Device-specific

**[SOURce<[1]|2>:]BB:DM:TRIGger:SLENgth 1 ... (2^32-1) Symbols**

The command defines the length of the signal sequence to be output in the **Single** trigger mode.

**Example:** "SOUR2:BB:DM:SEQ SING"  
'sets trigger mode Single.

"SOUR2:BB:DM:TRIG:SLEN 200"  
'sets a sequence length of 200 symbols. 200 symbols will be output after the next trigger event.

*RST value	Resolution	Options	SCPI
1000 Symbols	-	B10/B11 and B13 SOURce2 only with second option B9/B10/B11	Device-specific

**[SOURce<[1]|2>:]BB:DM:TRIGger:SOURce INTernal | EXTernal | BEXTernal | OBASeband**

The command selects the trigger source.

**Parameter: INTernal**  
Triggering is executed by means of the Trigger command  
SOURce<[1]|2>:BB:DM:TRIGger:EXECute,  
TRIGger:BB:DM:IMMEDIATE or \*TRG in the case of remote control and by means of **Execute Trigger** in the case of manual operation.

**EXTernal**  
Triggering is executed by means of the signal on the TRIGGER 1 connector.

**BEXTernal**  
Triggering is executed by means of the signal on the TRIGGER 2 connector.

**OBASeband**  
Triggering is executed by means of the trigger signal from the second path (two-path instruments only).

**Example:** "SOUR2:BB:DM:TRIG:SOUR EXT"  
'sets external triggering via the TRIGGER 1 connector for path B of a two-path instrument.

*RST value	Resolution	Options	SCPI
INTernal	-	B10/B11 and B13 SOURce2 only with second option B9/B10/B11	Device-specific



## DM Lists - Remote-Control Commands

The following section brings together the commands for defining and managing the data lists and control lists for digital modulation.

Lists are stored as files with specific file extensions in a user-definable directory (see table). The directory which applies to the commands that follow is defined using the command `MMEMoRY:CDIR`. Files in this directory can be accessed by quoting the file name. The path and extension are not needed.

List type	Content	File extension
Data List	Digital modulation data	*.dm_iqd
Control List	Digital modulation control data	*.dm_iqc
User Standards	User settings of digital modulation	*.dm_stu

It is not possible to use other file extensions with the commands. Attempting to do so will cause an error message. If the file extension is changed in any other way (e.g. by directly accessing the file system) the lists are no longer recognized and therefore invalid.

Command	Parameter	Default unit	Note
[SOURCE<[1]>:]BB:DM:CLIST:CATalog?			Query only
[SOURCE<[1]>:]BB:DM:CLIST:CoPY	<new_control_list_name>		No query
[SOURCE<[1]>:]BB:DM:CLIST:DATA	0   1, {0   1}   block data		No query
[SOURCE<[1]>:]BB:DM:CLIST:DELeTe	<control_list_name>		No query
[SOURCE<[1]>:]BB:DM:CLIST:POINts			Query only
[SOURCE<[1]>:]BB:DM:CLIST:SELeCt	<control_list_name>		Query only
[SOURCE<[1]>:]BB:DM:CLIST:TAG?	<control_list_name>, <tag_name>		Query only
[SOURCE<[1]>:]BB:DM:DLIST:CATalog?			Query only
[SOURCE<[1]>:]BB:DM:DLIST:CoPY	<new_data_list_name>		No query
[SOURCE<[1]>:]BB:DM:DLIST:DATA	0   1, {0   1}   block data		
[SOURCE<[1]>:]BB:DM:DLIST:DATA:APPend	0   1, {0   1}   block data		
[SOURCE<[1]>:]BB:DM:DLIST:DELeTe	<data_list_name>		No query
[SOURCE<[1]>:]BB:DM:DLIST:POINts			
[SOURCE<[1]>:]BB:DM:DLIST:SELeCt	<data_list_name>		
[SOURCE<[1]>:]BB:DM:DLIST:TAG?	<data_list_name>, <tag_name>		Query only
[SOURCE<[1]>:]BB:DM:SETTING:CATalog?			Query only
[SOURCE<[1]>:]BB:DM:SETTING:DELeTe	"setting_file"		No query
[SOURCE<[1]>:]BB:DM:SETTING:LOAD	"setting_file"		No query
[SOURCE<[1]>:]BB:DM:DMSETTING:STORe	"setting_file"		No query
[SOURCE<[1]>:]BB:DM:STANDARD:ULIST:CATalog?			Query only
[SOURCE<[1]>:]BB:DM:STANDARD:ULIST:DELeTe	"user_list"		No query
[SOURCE<[1]>:]BB:DM:STANDARD:ULIST:LOAD	"user_list"		No query
[SOURCE<[1]>:]BB:DM:STANDARD:ULIST:STORe	"user_list"		No query

**[SOURce<[1]|2>:]BB:DM:CLIS:CATalog?**

The command queries the control lists present in the default directory. The default directory is set using command `MMEM:CDIRectory`. A path can also be specified, in which case the files in the specified directory are read. When the names of the lists are returned they are separated by commas. The command only reads out files with the `*.dm_iqc` extension.

The control lists contain the control signals for digital modulation.

The command is a query command and therefore has no \*RST value.

**Example:**           `"BB:DM:CLIS:CAT?"`  
                   'queries which control lists are present in the default directory.  
                   Response: `"c_list1","c_list2","c_list3"`  
                   'control lists `c_list1`, `c_list2`, and `c_list3` are present.

*RST value	Resolution	Options	SCPI
-	-	B10/B11 and B13 SOURce2 only with second option B9/B10/B11	Device-specific

**[SOURce<[1]|2>:]BB:DM:CLIS:COPY <list name>**

The command copies the selected control list into the control list specified by `<list_name>`. If a control list with the specified name does not yet exist, it is created.

The source file has to be available in the default directory. The default directory is set using command `MMEM:CDIRectory`. A path can be specified, in which case the source file is copied into the file `<list_name>` in the specified directory. The file extension may be omitted. Only files with the file extension `*.dm_iqc` will be copied.

The command triggers an action and therefore has no \*RST value and no query form.

**Example:**           `"BB:DM:CLIS:SEL 'c_list1'"`  
                   'selects control list `c_list1`.  
                   `"BB:DM:CLIS:COPY 'c_list4'"`  
                   'copies the content of control list `c_list1` into control list `c_list4`. If this list already exists, its content is overwritten. If the list does not yet exist, it is created.

*RST value	Resolution	Options	SCPI
-	-	B10/B11 and B13 SOURce2 only with second option B9/B10/B11	Device-specific

**[SOURce<[1]>:]BB:DM:CLIS:DATA 0...255 | block data**

The command sends the data to the currently selected control list. If the list already contains data, it is overwritten. This command only writes data into the data section of the file. For a description of the general file format and the tags that are automatically generated see section "[R&S Vector Signal Generator Waveform and List Format](#)", page 6.88.

The values for the control signals are sent, arranged in a 8-bit value as follows:

Signal	Order	Decimal value of bits
Marker 1	LSBit	1
Marker 2		2
Marker 3		4
Marker 4		8
Burst =		16
LevAtt1		32
CWMod		64
Hop	MSBit	128

The data can also be sent as a binary block, each binary block being a 2-byte value in which the 16 bits represent the binary values (16-bit unsigned integer, 2 bytes, LSByte first). When binary data transmission is in use, command :SYSTEM:COMMunicate:GPIB:LTERminator EOI should be used to set the termination character mode to 'EOI control data message only' so that a random LF in the data sequence is not interpreted as End, thereby prematurely terminating the data transmission. The command ...LTER STANdard resets the mode.

\*RST has no effect on data lists. This command is without query-

**Example:** "BB:DM:CLIS:SEL 'c\_list1'"  
'selects the control list.  
"BB:DM:CLIS:DATA 0,0,0,0,8,8,8,0,0,0,0..."  
'enters the control values in list c\_list1. In the example, only ramps for marker 4 are set.

*RST value	Resolution	Options	SCPI
-	-	B10/B11 and B13 SOURce2 only with second option B9/B10/B11	Device-specific

**[SOURce<[1]>:]BB:DM:CLIS:DELeTe <list name>**

The command deletes the specified control list from the default directory. The default directory is set using command MMEM:CDIRectory. A path can also be specified, in which case the files in the specified directory are deleted. The file extension may be omitted. Only files with the file extension \*.dm\_iqc will be deleted.

The command triggers an action and therefore has no \*RST value and no query form.

**Example:** "BB:DM:CLIS:DEL 'c\_list3'"  
'deletes control list c\_list3.

*RST value	Resolution	Options	SCPI
-	-	B10/B11 and B13 SOURce2 only with second option B9/B10/B11	Device-specific

**[SOURce<[1]|2>:]BB:DM:CLIS:POINTs?**

The command queries the number of lines (2 bytes) in the currently selected list.

The command is a query command and therefore has no \*RST value.

**Example:**           "BB:DM:CLIS:SEL "c\_list1""  
                      'selects control list c\_list1.  
  
                      "BB:DM:CLIS:POIN?"  
                      'queries the number of lines in the control list.  
  
Response:        "20"  
                      'the control list consists of 20 lines.

*RST value	Resolution	Options	SCPI
-	-	B10/B11 and B13 SOURce2 only with second option B9/B10/B11	Device-specific

**[SOURce<[1]|2>:]BB:DM:CLIS:TAG? <control\_list\_name>, <tag\_name>**

The command queries the content of the specified tag in the selected file (for information on the tags used in the R&S Vector Signal Generator see section "[R&S Vector Signal Generator Waveform and List Format](#)", page 6.88).

The command is a query command and therefore has no \*RST value.

**Example:**           "BB:DM:CLIS:TAG 'c\_list1', 'date'"  
                      'queries the Date tag in control list c\_list1.  
  
Response:        "10.10.2003"  
                      'the control list was created on 10.10.2003.

*RST value	Resolution	Options	SCPI
-	-	B10/B11 and B13 SOURce2 only with second option B9/B10/B11	Device-specific

**[SOURce<[1]|2>:]BB:DM:CLIS:SElect <list name>**

The command selects the control list in the default directory. The default directory is set using command `MMEM:CDIRectory`. A path can also be specified, in which case the files in the specified directory are selected. If a control list with the specified name does not yet exist, it is created. The file extension may be omitted. Only files with the file extension `*.dm_iqc` will be selected or created.

The command triggers an action and therefore has no \*RST value and no query form.

**Example:**           "BB:DM:CLIS:SEL 'c\_list1'"  
                      'selects control list c\_list1.

*RST value	Resolution	Options	SCPI
-	-	B10/B11 and B13 SOURce2 only with second option B9/B10/B11	Device-specific

**[SOURce<[1]2>:]BB:DM:DLIS:CATalog?**

The command queries the data lists present in the default directory. The default directory is set using command `M MEM:CDIRectory`. A path can also be specified, in which case the files in the specified directory are read. When the names of the lists are returned they are separated by commas. The command only reads out files with the `*.dm_iqd` extension.

The data lists contain the modulation data for digital modulation.

The command is a query command and therefore has no `*RST` value. The numeric suffix on `SOURce<[1]2>` is ignored in this command.

**Example:** `"BB:DM:DLIS:CAT?"`  
'queries which data lists are present.

**Response:** `"d_list1","d_list2","d_list3"`  
'data lists d\_list1, d\_list2, d\_list3 are present.

*RST value	Resolution	Options	SCPI
-	-	B10/B11 and B13 SOURce2 only with second option B9/B10/B11	Device-specific

**[SOURce<[1]2>:]BB:DM:DLIS:COPY <list name>**

The command copies the selected data list into the data list specified by `<list_name>`. If a data list with the specified name already exists, it is overwritten. If it does not yet exist, it is created.

The source file has to be available in the default directory. The default directory is set using command `M MEM:CDIRectory`. A path can be specified, in which case the source file is copied into the file `<list_name>` in the specified directory. The file extension may be omitted. Only files with the file extension `*.dm_iqc` will be copied.

The command triggers an action and therefore has no `*RST` value and no query form.

**Example:** `"BB:DM:DLIS 'd_list1'"`  
'selects data list d\_list1.  
`"BB:DM:DLIS:COPY 'd_list2'"`  
'copies the content of data list d\_list1 into data list d\_list2. Any existing content in data list d\_list2 is overwritten.

*RST value	Resolution	Options	SCPI
-	-	B10/B11 and B13 SOURce2 only with second option B9/B10/B11	Device-specific

[SOURce<[1]|2>:]BB:DM:DLIS:DATA 0 | 1 {,0 | 1}.| block data

[SOURce<[1]|2>:]BB:DM:DLIS:DATA? [<start>[,<length>]]

The setting command sends the bit data to the data list selected with the aid of :BB:DM:DLIS:SELEct. Any existing content in the data list is overwritten. This command only writes data into the data section of the file. For a description of the general file format and the tags that are automatically generated see section "R&S Vector Signal Generator Waveform and List Format", page 6.88.

This command sends the bit data to the selected data list, which is overwritten. The data can also be sent as block data in binary or PACKed format (see section Parameters, block data), each byte being interpreted as 8 data bits. In this case, command :SYSTEM:COMMunicate:GPIB:LTERminator EOI should be used to set the termination character mode to 'EOI control data message only' so that a random LF in the data sequence is not interpreted as End, thereby prematurely terminating the data transmission. The command ...LTER STAN resets the mode.

**Example:** "BB:DM:DLIS:SEL 'dlist1'"  
 'selects data list dlist1. If the file does not yet exist, it is created.  
 "BB:DM:DLIS:DATA 1,1,1,0,0,0,1,1,0,1..."  
 'sends the specified data to file dlist1. Any data already present is overwritten.

The query reads out the data part of the data list. If the query is expanded by using the two parameters <start> and <length>, the list is read out in smaller sections. Start and Length are expressed in bits. Without the parameters the total length is always read out starting from address 1. The command :FORMat ASCii | PACKed can be used to select the data format. The byte sequence is defined in the IEC bus standard (read/write most significant byte first).

**Example:** "BB:DM:DLIS:SEL 'dlist1'"  
 'selects data list dlist1.  
 "FORM ASCII"  
 'selects ASCII data transmission format.  
 "BB:DM:DLIS:DATA? 2048,1024"  
 'queries the data starting at bit 2048 for 1024 bits.

\*RST has no effect on data lists.

*RST value	Resolution	Options	SCPI
-	-	B10/B11 and B13 SOURce2 only with second option B9/B10/B11	Device-specific

**[SOURce<[1]>:]BB:DM:DLIS:DATA:APPend 0 | 1 {,0 | 1}.| block data**

The command appends the bit data onto the end of the existing data in the selected data list. This means that existing content in the data list is not overwritten. By this means very long data lists can be built up piecemeal. The data format is as specified in command SOURce:BB:DM:DLIS:DATA.

The command cannot be used with an empty data list, such as one that has just been created, for example. In this case the command SOURce:BB:DM:DLIS:DATA must first be used to enter modulation data in the list.

\*RST has no effect on data lists.

**Example 1:**       "BB:DM:DLIS:SEL ' d\_list2'"  
                  'selects data list d\_list2.'  
  
                  "FORM ASC"  
                  'selects ASCII data transmission format.'  
  
                  "BB:DM:DLIS:DATA:APP 1,1,1,0,0,0,1,1,0,1..."  
                  'adds the specified numeric data to the existing data in data list d\_list2.'

*RST value	Resolution	Options	SCPI
-	-	B10/B11 and B13 SOURce2 only with second option B9/B10/B11	Device-specific

**[SOURce<[1]>:]BB:DM:DLIS:DELeTe <list name>**

The command deletes the specified data list. from the default directory. The default directory is set using command MMEM:CDIRectory. A path can also be specified, in which case the files in the specified directory are deleted. The file extension may be omitted. Only files with the file extension \*.dm\_iqd will be deleted.

The command triggers an action and therefore has no \*RST value and no query form. The numeric suffix on SOURce<[1]> is ignored in this command.

**Example:**       "BB:DM:DLIS:DEL ' d\_list2'"  
                  'deletes data list d\_list2.'

*RST value	Resolution	Options	SCPI
-	-	B10/B11 and B13 SOURce2 only with second option B9/B10/B11	Device-specific

**[SOURce<[1]>:]BB:DM:DLIS:POINTs <n>**

The command defines the number of bits in the selected data list to be utilized. When a list is being filled with block data, this data is only ever sent in multiples of 8 bits. However the exact number of bits to be exploited can be set to a different figure. The superfluous bits in the list are then ignored.

The command triggers an action and therefore has no \*RST value and no query form.

**Example:**       "BB:DM:DLIS:POIN 234"  
                  'defines the number of bits in the data list to be utilized as 234 bits. If the list was filled with block data, at least the last 6 bits will be ignored.'

*RST value	Resolution	Options	SCPI
-	-	B10/B11 and B13 SOURce2 only with second option B9/B10/B11	Device-specific

**[SOURce<[1]>:]BB:DM:DLIS:SELect <list name>**

The command selects the data list in the default directory. The default directory is set using command `MMEM:CDIRectory`. A path can also be specified, in which case the files in the specified directory are selected. If a data list with the specified name does not yet exist, it is created. The file extension may be omitted. Only files with the file extension `*.dm_iqd` will be selected or created.

The modulation data in this data list is used when the data source is selected using the command `"SOURce:BB:DM:SOURce DLIS"`.

The command triggers an action and therefore has no `*RST` value and no query form.

**Example:** `"BB:DM:DLIS:SEL ' d_list2'"`  
 'selects data list d\_list2.'

*RST value	Resolution	Options	SCPI
-	-	B10/B11 and B13 SOURce2 only with second option B9/B10/B11	Device-specific

**[SOURce<[1]>:]BB:DM:DLIS:TAG? <control\_list\_name>, <tag\_name>**

The command queries the content of the specified tag in the selected file (for information on the tags used in the R&S Vector Signal Generator see section ["R&S Vector Signal Generator Waveform and List Format"](#), page 6.88).

The command is a query command and therefore has no `*RST` value.

**Example:** `"BB:DM:DLIS:TAG 'D_list1', 'date'"`  
 'queries the Date tag in control list D\_list1.'

Response: `"10.10.2003"`  
 'the data list was created on 10.10.2003.'

*RST value	Resolution	Options	SCPI
-	-	B10/B11 and B13 SOURce2 only with second option B9/B10/B11	Device-specific

**[SOURce<[1]>:]BB:DM:SETTing:CATalog?**

This command reads out the files with Custom Digital Modulation settings in the default directory. The default directory is set using command `MMEM:CDIRectory`. A path can also be specified, in which case the files in the specified directory are read. Only files with the file extension `*.dm` will be listed.

The command is a query command and therefore has no `*RST` value.

**Example:** `"MMEM:CDIR 'D:\user\dig_mod'"`  
 'sets the default directory to D:\user\dig\_mod.'

`"BB:DM:SETT:CAT?"`  
 'reads out all the files with Custom Digital Modulation settings in the default directory.'

Response: `"'DM_1'"`  
 'the file 'DM\_1' with Custom Digital Modulation settings is available.'

*RST value	Resolution	Options	SCPI
	-	B10/B11 and B13 SOURce2 only with second option B9/B10/B11	Device-specific



**[SOURce<[1]2>:]BB:DM:SETTING:DELete <file\_name>**

This command deletes the selected file with Custom Digital Modulation settings. The directory is set using command `MMEM:CDIRectory`. A path can also be specified, in which case the files in the specified directory are read. The file extension may be omitted. Only files with the file extension `*.dm` will be deleted.

This command triggers an event and therefore has no `*RST` value and no query form.

**Example:**           `"BB:DM:STAN:ULIS:DEL 'DM_1'"`  
                           ' deletes file 'DM\_1'.

*RST value	Resolution	Options	SCPI
	-	B10/B11 and B13 SOURce2 only with second option B9/B10/B11	Device-specific

**[SOURce<[1]2>:]BB:DM:SETTING:LOAD <file\_name>**

This command loads the selected file with Custom Digital Modulation settings. The directory is set using command `MMEM:CDIRectory`. A path can also be specified, in which case the files in the specified directory are read. The file extension may be omitted. Only files with the file extension `*.dm` will be loaded.

This command triggers an event and therefore has no `*RST` value and no query form.

**Example:**           `"BB:DM:STAN:ULIS:LOAD 'DM_1'"`  
                           ' loads file 'DM\_1'.

*RST value	Resolution	Options	SCPI
	-	B10/B11 and B13 SOURce2 only with second option B9/B10/B11	Device-specific

**[SOURce<[1]2>:]BB:DM:SETTING:STORe <file\_name>**

This command stores the current Custom Digital Modulation settings into the selected file. The directory is set using command `MMEM:CDIRectory`. A path can also be specified, in which case the files in the specified directory are read. Only the file name has to be entered. User Standards are stored as files with the specific file extensions `*.dm`.

This command triggers an event and therefore has no `*RST` value and no query form.

**Example:**           `"BB:DM:STAN:ULIS:STOR 'DM_QAM'"`  
                           ' stores the current Custom Digital Modulation settings into file 'DM\_QAM'.

*RST value	Resolution	Options	SCPI
	-	B10/B11 and B13 SOURce2 only with second option B9/B10/B11	Device-specific

**[SOURce<[1]>:]BB:DM:STANDARD:ULIST:CATalog?**

This command reads out the files with Digital Standard settings in the default directory. The default directory is set using command `MMEM:CDIRectory`. A path can also be specified, in which case the files in the specified directory are read. Only files with the file extension `*.dm_stu` will be listed.

The command is a query command and therefore has no \*RST value.

**Example:** `"MMEM:CDIR 'D:\user\dig_mod"`  
                   'sets the default directory to D:\user\dig\_mod.  
`"BB:DM:STAN:ULIS:CAT?"`  
                   'reads out all the files with Digital Standard settings in the default directory.  
**Response:** `" 'DM_QAM' "`  
                   'the file 'DM\_QAM' with Digital Standard settings is available.

*RST value	Resolution	Options	SCPI
	-	B10/B11 and B13 SOURce2 only with second option B9/B10/B11	Device-specific

**[SOURce<[1]>:]BB:DM:STANDARD:ULIST:DELeTe <file\_name>**

This command deletes the selected file with Digital Standard settings. The directory is set using command `MMEM:CDIRectory`. A path can also be specified, in which case the files in the specified directory are read. The file extension may be omitted. Only files with the file extension `*.dm_stu` will be deleted.

This command triggers an event and therefore has no \*RST value and no query form.

**Example:** `"BB:DM:STAN:ULIS:DEL 'DM_QAM' "`  
                   'deletes file 'DM\_QAM'.

*RST value	Resolution	Options	SCPI
	-	B10/B11 and B13 SOURce2 only with second option B9/B10/B11	Device-specific

**[SOURce<[1]>:]BB:DM:STANDARD:ULIST:LOAD <file\_name>**

This command loads the selected file with Digital Standard settings. The directory is set using command `MMEM:CDIRectory`. A path can also be specified, in which case the files in the specified directory are read. The file extension may be omitted. Only files with the file extension `*.dm_stu` will be loaded.

This command triggers an event and therefore has no \*RST value and no query form.

**Example:** `"BB:DM:STAN:ULIS:LOAD 'DM_QAM' "`  
                   'loads file 'DM\_QAM'.

*RST value	Resolution	Options	SCPI
	-	B10/B11 and B13 SOURce2 only with second option B9/B10/B11	Device-specific

[SOURce<[1]|2>:]BB:DM:STANdard:ULIS:STORe <file\_name>

This command stores the current Digital Standard settings into the selected file. The directory is set using command `MMEM:CDIRectory`. A path can also be specified, in which case the files in the specified directory are read. Only the file name has to be entered. User Standards are stored as files with the specific file extensions `*.dm_stu`.

This command triggers an event and therefore has no \*RST value and no query form.

**Example:**           `"BB:DM:STAN:ULIS:STOR 'DM_QAM'"`  
                           'stores the current Digital Standard settings into file 'DM\_QAM'.

*RST value	Resolution	Options	SCPI
	-	B10/B11 and B13 SOURce2 only with second option B9/B10/B11	Device-specific

# SOURce:BB:GPS Subsystem

## SOURce-GPS - Primary Commands

This subsystem contains commands for the primary and general settings of the GPS standard. These settings concern activation and deactivation of the standard, setting the filter, clock, trigger and clipping settings, defining the frame duration and the sequence length, as well as the preset setting.

The commands for defining the satellite signal are described in the next section.

The numerical suffix at SOURce distinguishes between path A and path B for two-path instruments:

SOURce<1> = path A

SOURce2 = path B

The keyword SOURce is optional with commands for path A and can be omitted. For path B, the command must include the keyword with the suffix 2.

Command	Parameters	Default unit	Comments
[SOURce<[1] 2>:]BB:GPS:CLOCK:MODE	CHIP   MCHip		
[SOURce<[1] 2>:]BB:GPS:CLOCK:MULTIplier	1... 64		
[SOURce<[1] 2>:]BB:GPS:CLOCK:SOURce	EXTernal   INTernal		
[SOURce<[1] 2>:]BB:GPS:LOCation:ALTititude	-10.000 m... 10.000 m	m	
[SOURce<[1] 2>:]BB:GPS:LOCation	User Defined   Munich   New York   Sydney		
[SOURce<[1] 2>:]BB:GPS:LOCation:LATitude:DEGREes	0.0...90.0		
[SOURce<[1] 2>:]BB:GPS:LOCation:LATitude:DIRection	NORTTh   SOUTH		
[SOURce<[1] 2>:]BB:GPS:LOCation:LATitude:MINutes	0.0...59.0		
[SOURce<[1] 2>:]BB:GPS:LOCation:LATitude:SEConds	0.0...59.0		
[SOURce<[1] 2>:]BB:GPS:LOCation:LONGitude:DEGREes	0.0...180		
[SOURce<[1] 2>:]BB:GPS:LOCation:LONGitude:DIRection	EAST   WEST		
[SOURce<[1] 2>:]BB:GPS:LOCation:LONGitude:MINutes	0.0...59.0		
[SOURce<[1] 2>:]BB:GPS:LOCation:LONGitude:SEConds	0.0...59.0		
[SOURce<[1] 2>:]BB:GPS:POWER:ADJust			No query
[SOURce<[1] 2>:]BB:GPS:POWER[TOTal]			No query
[SOURce<[1] 2>:]BB:GPS:PRESet			No query
[SOURce<[1] 2>:]BB:GPS:PRFLevel			No query
[SOURce<[1] 2>:]BB:GPS:SEQUence	AUTO   RETRigger   AAUTO   ARETrigger   SINGle		
[SOURce<[1] 2>:]BB:GPS:SETTING:CATalog?			Query only
[SOURce<[1] 2>:]BB:GPS:SETTING:DELeTe	<file_name>		

Command	Parameters	Default unit	Comments
[SOURce<[1] 2>:]BB:GPS:SETTing:LOAD	<file_name>		
[SOURce<[1] 2>:]BB:GPS:SETTing:STORe	<file_name>		
[SOURce<[1] 2>:]BB:GPS:SMODe	GENERIC   LOCALization		
[SOURce<[1] 2>:]BB:GPS:SPRReading[:STATe]	ON   OFF		
[SOURce<[1] 2>:]BB:GPS:STATe	ON   OFF		
[SOURce<[1] 2>:]BB:GPS:TRIGger:ARM:EXECute			No query
[SOURce<[1] 2>:]BB:GPS:TRIGger:EXECute			No query
[SOURce<[1] 2>:]BB:GPS:TRIGger[:EXTernal<[1] 2>]:DELay	0 ... (2 <sup>32</sup> - 1) chips		
[SOURce<[1] 2>:]BB:GPS:TRIGger[:EXTernal<[1] 2>]:INHibit	0 ... (2 <sup>32</sup> - 1) chips		
[SOURce<[1] 2>:]BB:GPS:TRIGger:OBASeband:DELay	0 ... (2 <sup>32</sup> - 1) chips		
[SOURce<[1] 2>:]BB:GPS:TRIGger:OBASeband:INHibit	0 ... (2 <sup>32</sup> - 1) chips		
[SOURce<[1] 2>:]BB:GPS:TRIGger:OUTPut<[1]...4>:DELay	0 ... (2 <sup>32</sup> - 1) chips		
[SOURce<[1] 2>:]BB:GPS:TRIGger:OUTPut:DELay:FIXed	ON   OFF	Hz	
[SOURce<[1] 2>:]BB:GPS:TRIGger:OUTPut<[1]...4>:DELay:MAXimum			Query only
[SOURce<[1] 2>:]BB:GPS:TRIGger:OUTPut<[1]...4>:DELay:MINimum			Query only
[SOURce<[1] 2>:]BB:GPS:TRIGger:OUTPut<[1]...4>:MODE	NBIT   WORD   SFRame   PAGE   MESSage   PULSe   PATTErn   RATio		
[SOURce<[1] 2>:]BB:GPS:TRIGger:OUTPut<[1]...4>:OFFTime	2 ... (2 <sup>24</sup> - 1) chips		
[SOURce<[1] 2>:]BB:GPS:TRIGger:OUTPut<[1]...4>:ONTime	2 ... (2 <sup>24</sup> - 1) chips		
[SOURce<[1] 2>:]BB:GPS:TRIGger:OUTPut<[1]...4>:PATTErn	#B0,1...#B111..1,32		
[SOURce<[1] 2>:]BB:GPS:TRIGger:OUTPut<[1]...4>:PULSe:DIVider	2 ... 1024		
[SOURce<[1] 2>:]BB:GPS:TRIGger:OUTPut<[1]...4>:PULSe:FREQuency			Query only
[SOURce<[1] 2>:]BB:GPS:TRIGger:RMODE			Query only
[SOURce<[1] 2>:]BB:GPS:TRIGger:SLENgth	0 ... (2 <sup>32</sup> - 1) chips		
[SOURce<[1] 2>:]BB:GPS:TRIGger:SLENgth:UNIT	SFRame   CHIP   NBIT   CNMessage		
[SOURce<[1] 2>:]BB:GPS:TRIGger:SOURce	EXTernal   INTernal   BEXTernal   OBASeband		

**[SOURce<[1]|2>:]BB:GPS:CLOCK:MODE CHIP | MCHip**

The command enters the type of externally supplied clock (:BB:GPS:CLOCK:SOURce EXTernal).

When MCHip is used, a multiple of the chip clock is supplied via the CLOCK connector and the chip clock is derived internally from this. The multiplier is entered with the command

:BB:GPS:CLOCK:MULTiplier.

With this command the only numerical suffix allowed for SOURce is 1, since the external clock source is permanently allocated to path A.

**Example:** "BB:GPS:CLOC:MODE CHIP"  
'selects clock type **Chip**, i.e. the supplied clock is a chip clock.

*RST value	Resolution	Options	SCPI
CHIP	-	B10/B11 and B13 K44 SOURce2 only with second option B9/B10/B11	Device-specific

**[SOURce<[1]|2>:]BB:GPS:CLOCK:MULTiplier 1 ... 64**

The command specifies the multiplier for clock type **Multiplied** (:BB:GPS:CLOCK:MODE MCHip) in the case of an external clock source.

With this command the only numerical suffix allowed for SOURce is 1, since the external clock source is permanently allocated to path A.

**Example:** "BB:GPS:CLOC:SOUR EXT"  
'selects the external clock source. The clock is supplied via the CLOCK connector.

"BB:GPS:CLOC:MODE MCH"  
'selects clock type **Multiplied**, i.e. the supplied clock has a rate which is a multiple of the chip rate.

"BB:GPS:CLOC:MULT 12"  
'the multiplier for the external clock rate is 12.

*RST value	Resolution	Options	SCPI
4	1	B10/B11 and B13 K44 SOURce2 only with second option B9/B10/B11	Device-specific

[SOURce<[1]]2>:]BB:GPS:CLOCK:SOURce INTernal | EXTernal

The command selects the clock source.

Selecting EXTernal is only possible for path A, since the external clock source is permanently allocated to path A.

**Parameter:**     **INTernal**  
                           The internal clock reference is used.

**EXTernal**  
                           The external clock reference is supplied to the CLOCK connector.

**Example:**        "BB:GPS:CLOC:SOUR EXT"  
                           'selects an external clock reference for path A. The clock is supplied via the  
                           CLOCK connector.

"BB:GPS:CLOC:MODE CHIP"  
                           'specifies that a chip clock is supplied via the CLOCK connector.

*RST value	Resolution	Options	SCPI
INTernal	-	B10/B11 and B13 K44 SOURce2 only with second option B9/B10/B11	Device-specific

[SOURce<[1]]2>:]BB:GPS:LOCation:ALTitude -10.000 m...10.000 m

The command sets the geographic altitude.

This field is only available for user defined geographic locations. If a value other than **User Defined** is selected in the **Geographic Location** field, the **Altitude** field is read only.

**Example:**        "SOUR:BB:GPS:LOC ALT 500"  
                           'sets the geographic altitude to 500 m.

*RST value	Resolution	Options	SCPI
0.0	-	B10/B11 and B13 K44 SOURce2 only with second option B9/B10/B11	Device-specific

[SOURce<[1]]2>:]BB:GPS:LOCation User Defined | Munich | New York | Sydney

The command sets the geographic location.

**Example:**        "SOUR:BB:GPS:LOC "Munich"  
                           'sets the geographic location to Munich.

*RST value	Resolution	Options	SCPI
User Defined	-	B10/B11 and B13 K44 SOURce2 only with second option B9/B10/B11	Device-specific

**[SOURce<[1]|2>:]BB:GPS:LOCation:LATitude:DEGRees 0.0...90.0**

The command sets the latitude of the geographic location in ° (degrees).

**Example:** "SOUR:BB:GPS:LOC:LAT:DEGR 48"  
 'sets the latitude of the geographic location to 48° (degrees).

*RST value	Resolution	Options	SCPI
0.0	-	B10/B11 and B13 K44 SOURce2 only with second option B9/B10/B11	Device-specific

**[SOURce<[1]|2>:]BB:GPS:LOCation:LATitude:DIRection NORTH | SOUTH**

The command sets the direction of the geographic location related to the latitude.

**Example:** "SOUR:BB:GPS:LOC:LAT:DIR NORT"  
 'sets the direction of the geographic location to NORTH.

*RST value	Resolution	Options	SCPI
NORTH	-	B10/B11 and B13 K44 SOURce2 only with second option B9/B10/B11	Device-specific

**[SOURce<[1]|2>:]BB:GPS:LOCation:LATitude:MINutes 0.0...59.0**

The command sets the latitude of the geographic location in ' (minutes).

**Example:** "SOUR:BB:GPS:LOC:LAT:MIN 9"  
 'sets the latitude of the geographic location to 9'.

*RST value	Resolution	Options	SCPI
0.0	-	B10/B11 and B13 K44 SOURce2 only with second option B9/B10/B11	Device-specific

**[SOURce<[1]|2>:]BB:GPS:LOCation:LATitude:SECConds 0.0...59.0**

The command sets the latitude of the geographic location in " (seconds).

**Example:** "SOUR:BB:GPS:LOC:LAT:SEC 0"  
 'sets the latitude of the geographic location to 0".'

*RST value	Resolution	Options	SCPI
0.0	-	B10/B11 and B13 K44 SOURce2 only with second option B9/B10/B11	Device-specific



**[SOURce<[1]>:]BB:GPS:LOCation:LONGitude:DEGRees 0.0...180.0**

The command sets the longitude of the geographic location in ° (degrees).

**Example:** "SOUR:BB:GPS:LOC:LONG:DEGR 11"  
 'sets the longitude of the geographic location to 11° (degrees).

*RST value	Resolution	Options	SCPI
0.0	-	B10/B11 and B13 K44 SOURce2 only with second option B9/B10/B11	Device-specific

**[SOURce<[1]>:]BB:GPS:LOCation:LONGitude:DIRection EAST | WEST**

The command sets the direction of the geographic location related to the longitude.

**Example:** "SOUR:BB:GPS:LOC:LONG:DIR EAST"  
 'sets the direction of the geographic location to EAST.

*RST value	Resolution	Options	SCPI
EAST	-	B10/B11 and B13 K44 SOURce2 only with second option B9/B10/B11	Device-specific

**[SOURce<[1]>:]BB:GPS:LOCation:LONGitude:MINutes 0.0...59.0**

The command sets the longitude of the geographic location in ' (minutes).

**Example:** "SOUR:BB:GPS:LOC:LONG:MIN 35"  
 'sets the longitude of the geographic location to 35'.

*RST value	Resolution	Options	SCPI
0.0	-	B10/B11 and B13 K44 SOURce2 only with second option B9/B10/B11	Device-specific

**[SOURce<[1]>:]BB:GPS:LOCation:LONGitude:SECConds 0.0...59.0**

The command sets the longitude of the geographic location in " (seconds).

**Example:** "SOUR:BB:GPS:LOC:LONG:SEC 0"  
 'sets the latitude of the geographic location to 0"'.  
 (Note: The original text contains a typo 'latitude' which has been corrected to 'longitude' in this transcription.)

*RST value	Resolution	Options	SCPI
0.0	-	B10/B11 and B13 K44 SOURce2 only with second option B9/B10/B11	Device-specific

**[SOURce<[1]|2>:]BB:GPS:POWER[:TOTal]?**

The command queries the total power of all satellites. After **Power Adjust**, this power corresponds to 0 dB.

The command is a query command and therefore does not have an \*RST value.

**Example:** "BB:GPS:POW?"  
'queries the total power of all satellites.

Response: "-22.5"  
'the total power is -25 dB.

*RST value	Resolution	Options	SCPI
-	-	B10/B11 and B13 K44 SOURce2 only with second option B9/B10/B11	Device-specific

**[SOURce<[1]|2>:]BB:GPS:POWER:ADJust**

The command calculates the power level of each satellite so that the sum of all levels results in 0 dB.

The command triggers an action and therefore has no \*RST value and no query form.

**Example:** "BB:GPS:POW:ADJ"  
'the total power of all satellites is set to 0 dB.

*RST value	Resolution	Options	SCPI
-	-	B10/B11 and B13 K44 SOURce2 only with second option B9/B10/B11	Device-specific

**[SOURce<[1]|2>:]BB:GPS:PRESet**

The command produces a standardized default for all GPS settings. The settings correspond to the \*RST values specified for the commands.

This command triggers an action and therefore has no \*RST value and no query form.

**Example:** "BB:GPS:PRES"  
'resets all the GPS settings to default values.

*RST value	Resolution	Options	Dependencies	SCPI
-	-	B10/B11 and B13 K44 SOURce2 only with second option B9/B10/B11	All GPS settings are preset.	Device-specific

**[SOURce<[1]|2>:]BB:GPS:PRFLevel**

The command sets the RF to GPS standard L1 (1.575420 GHz) and the power level to -115.0 dBm. The affected RF path depends on the signal routing of the selected baseband.

This command triggers an action and therefore has no \*RST value and no query form.

**Example:** "BB:GPS:PRFL"  
 'sets the RF level to 1.575420 GHz and the level to -115.0 dBm.

*RST value	Resolution	Options	Dependencies	SCPI
-	-	B10/B11 and B13 K44 SOURce2 only with second option B9/B10/B11	Sets commands SOUR:FREQ and SOUR:POW	Device-specific

**[SOURce<[1]|2>:]BB:GPS:SEQuence** AUTO | RETRigger | AAUTo | ARETrigger | SINGle

The command selects the trigger mode.

**Parameter:** **AUTO**  
 The modulation signal is generated continuously.

**RETRigger**  
 The modulation signal is generated continuously. A trigger event (internal or external) causes a restart.

**AAUTo**  
 The modulation signal is generated only when a trigger event occurs. After the trigger event the signal is generated continuously. Signal generation is stopped with command SOUR:BB:GPS:TRIG:ARM:EXEC and started again when a trigger event occurs.

**ARETrigger**  
 The modulation signal is generated only when a trigger event occurs. The device automatically toggles to RETRIG mode. Every subsequent trigger event causes a restart.  
 Signal generation is stopped with command SOUR:BB:GPS:TRIG:ARM:EXEC and started again when a trigger event occurs.

**SINGle**  
 The modulation signal is generated only when a trigger event occurs. Then the signal is generated once to the length specified with command SOUR:BB:GPS:TRIG:SLen. Every subsequent trigger event causes a restart.

**Example:** "BB:GPS:SEQ AAUT"  
 'sets the **Armed\_auto** trigger mode; the device waits for the first trigger (e.g. with \*TRG) and then generates the signal continuously.

*RST value	Resolution	Options	SCPI
AUTO	-	B10/B11 and B13 K44 SOURce2 only with second option B9/B10/B11	Device-specific

**[SOURce<[1]>:]BB:GPS:SETTing:CATalog?**

This command reads out the files with IEEE 802.16 settings in the default directory. The default directory is set using command `MMEM:CDIRectory`. A path can also be specified, in which case the files in the specified directory are read. Only files with the file extension `*.gps` will be listed.

The command is a query command and therefore has no `*RST` value.

**Example:** `"MMEM:CDIR 'D:\user\gps"`  
 'sets the default directory to D:\user\gps.  
`"BB:GPS:SETT:CAT?"`  
 'reads out all the files with GPS settings in the default directory.  
 Response: `"'gps_generic', 'gps_gen2'"`  
 'the files `'gps_generic'` and `'gps_gen2'` are available.

*RST value	Resolution	Options	SCPI
	-	B10/B11 and B13 K44 SOURce2 only with second option B9/B10/B11	Device-specific

**[SOURce<[1]>:]BB:GPS:SETTing:DELete <file\_name>**

This command deletes the selected file with GPS settings The directory is set using command `MMEM:CDIRectory`. A path can also be specified, in which case the files in the specified directory are read. The file extension may be omitted. Only files with the file extension `*.gps` will be deleted.

This command triggers an event and therefore has no `*RST` value and no query form.

**Example:** `"BB:GPS:SETT:DEL 'gps'"`  
 'deletes file 'gps'.

*RST value	Resolution	Options	SCPI
	-	B10/B11 and B13 K44 SOURce2 only with second option B9/B10/B11	Device-specific

**[SOURce<[1]>:]BB:GPS:SETTing:LOAD <file\_name>**

This command loads the selected file with GPS settings The directory is set using command `MMEM:CDIRectory`. A path can also be specified, in which case the files in the specified directory are read. The file extension may be omitted. Only files with the file extension `*.gps` will be loaded.

This command triggers an event and therefore has no `*RST` value and no query form.

**Example:** `"BB:GPS:SETT:LOAD 'gps'"`  
 'loads file 'gps'.

*RST value	Resolution	Options	SCPI
	-	B10/B11 and B13 K44 SOURce2 only with second option B9/B10/B11	Device-specific

[SOURce<[1]>:]BB:GPS:SETTing:STORe <file\_name>

This command stores the current GPS settings into the selected file. The directory is set using command `MMEM:CDIRectory`. A path can also be specified, in which case the files in the specified directory are read. Only the file name has to be entered. GPS settings are stored as files with the specific file extensions `*.gps`.

This command triggers an event and therefore has no `*RST` value and no query form.

**Example:** `"BB:GPS:SETT:STOR 'gps_sem299'"`  
 'stores the current settings into file 'gps\_sem299'.

*RST value	Resolution	Options	SCPI
	-	B10/B11 and B13 K44 SOURce2 only with second option B9/B10/B11	Device-specific

[SOURce<[1]>:]BB:GPS:SMODe GENeric | LOCalization

The command sets the simulation mode.

**Example:** `"BB:GPS:SMOD GEN"`  
 'generic satellite signals are generated.

*RST value	Resolution	Options	Dependencies	SCPI
GENeric	-	B10/B11 and B13 K44 SOURce2 only with second option B9/B10/B11	BB:GPS:STAT ON deactivates the other standards and digital modulation.	Device-specific

[SOURce<[1]>:]BB:GPS:SPReading[:STATe] ON | OFF

The command activates/deactivates spreading. When spreading is deactivated the pure navigation data is modulated onto the RF carrier.

**Example:** `"BB:GPS:SPR ON"`  
 'activates spreading of simulated GPS satellite signals.

*RST value	Resolution	Options	SCPI
ON	-	B10/B11 and B13 K44 SOURce2 only with second option B9/B10/B11	Device-specific

[SOURce<[1]|2>:]BB:GPS:STATe ON | OFF

The command activates the signal generation of a simulated GPS satellite. Activating this standard deactivates all the other digital standards and digital modulation modes on the same path.

**Example:** "BB:GPS:STAT ON"  
'activates signal generation of a simulated GPS satellite.

*RST value	Resolution	Options	Dependencies	SCPI
OFF	-	B10/B11 and B13 K44 SOURce2 only with second option B9/B10/B11	BB:GPS:STAT ON deactivates the other standards and digital modulation.	Device-specific

[SOURce<[1]|2>:]BB:GPS:TRIGger:ARM:EXECute

The command stops signal generation for trigger modes Armed\_Auto and Armed\_Retrigger. A subsequent internal or external trigger event restart signal generation.

This command triggers an event and therefore has no \*RST value and no query form.

**Example:** "BB:GPS:TRIG:SOUR INT"  
'sets internal triggering.

"BB:GPS:TRIG:SEQ ARET"  
'sets Armed\_Retrigger mode, i.e. every trigger event causes signal generation to restart.

"BB:GPS:TRIG:EXEC"  
'executes a trigger, signal generation is started.

"BB:GPS:TRIG:ARM:EXEC"  
'signal generation is stopped.

"BB:GPS:TRIG:EXEC"  
'executes a trigger, signal generation is started again.

*RST value	Resolution	Options	SCPI
		B10/B11 and B13 K44 SOURce2 only with second option B9/B10/B11	Device-specific

**[SOURce<[1]|2>:]BB:GPS:TRIGger:EXECute**

The command executes a trigger. The internal trigger source must be selected using the command :BB:GPS:TRIG:SOUR INT and a trigger mode other than AUTO must be selected using the command :BB:GPS:TRIG:SEQ.

This command triggers an event and therefore has no \*RST value and no query form.

**Example:** "BB:GPS:TRIG:SOUR INT"  
'sets internal triggering.

"BB:GPS:TRIG:SEQ RETR"  
'sets Retrigger mode, i.e. every trigger event causes signal generation to restart.

"BB:GPS:TRIG:EXEC"  
'executes a trigger.

*RST value	Resolution	Options	SCPI
		B10/B11 and B13 K44 SOURce2 only with second option B9/B10/B11	Device-specific

**[SOURce<[1]|2>:]BB:GPS:TRIGger[:EXTernal<[1]|2>]:DELay 0 ... 2^32-1**

The command specifies the trigger delay (expressed as a number of chips) for external triggering. The numeric suffix to EXTernal distinguishes between the external trigger via the TRIGGER 1 (suffix 1) and TRIGGER 2 (suffix 2) connector.

**Example:** "BB:GPS:TRIG:SOUR EXT"  
'sets an external trigger via the TRIGGER 1 connector.

"BB:GPS:TRIG:DEL 50"  
'sets a delay of 50 chips for the trigger.

*RST value	Resolution	Options	SCPI
0 chips	1 chip	B10/B11 and B13 K44 SOURce2 only with second option B9/B10/B11	Device-specific

**[SOURce<[1]|2>:]BB:GPS:TRIGger[:EXTernal<[1]|2>]:INHibit 0 ... 2^32-1**

The command specifies the number of chips by which a restart is to be inhibited following a trigger event. This command applies only in the case of external triggering. The numeric suffix to EXTernal distinguishes between the external trigger via the TRIGGER 1 (suffix 1) and TRIGGER 2 (suffix 2) connector.

**Example:** "BB:GPS:TRIG:SOUR EXT"  
'selects an external trigger via the TRIGGER 1 connector.

"BB:GPS:TRIG:INH 200"  
'sets a restart inhibit for 200 chips following a trigger event.

*RST value	Resolution	Options	SCPI
0 chips	1 chip	B10/B11 and B13 K44 SOURce2 only with second option B9/B10/B11	Device-specific

[SOURce<[1]|2>:]BB:GPS:TRIGger:OBASband:DELay 0 ... 2<sup>32</sup>-1

The command specifies the trigger delay (expressed as a number of chips) for triggering by the trigger signal from the second path (two-path instruments only).

**Example:** "BB:GPS:TRIG:SOUR OBAS"  
 'sets for path A the internal trigger executed by the trigger signal from the second path (path B).

"BB:GPS:TRIG:OBAS:DEL 50"  
 'sets a delay of 50 chips for the trigger.

*RST value	Resolution	Options	SCPI
0 chips	1 chips	B10/B11 and B13 K44 Only with second option B13	Device-specific

[SOURce<[1]|2>:]BB:GPS:TRIGger:OBASband:INHibit 0 ... 2<sup>32</sup>-1

The command specifies the number of chips by which a restart is to be inhibited following a trigger event. This command applies only for triggering by the second path (two-path instruments only).

**Example:** "BB:GPS:TRIG:SOUR OBAS"  
 'sets for path A the internal trigger executed by the trigger signal from the second path (path B).

"BB:GPS:TRIG:INH 200"  
 'sets a restart inhibit for 200 chips following a trigger event.

*RST value	Resolution	Options	SCPI
0 chips	1 chip	B10/B11 and B13 K44 Only with second option B13	Device-specific

[SOURce<[1]|2>:]BB:GPS:TRIGger:OUTPut<[1]...4>:DELay 0 ... 2<sup>32</sup> - 1 Chips

The command defines the delay between the signal on the marker outputs and the start of the signal, expressed in terms of chips. Command :BB:GPS:TRIGger:OUTPut:DELay:FIXed can be used to restrict the range of values to the dynamic range, i.e. the range within which a delay of the marker signals can be set without restarting the marker and signal.

**Example:** "BB:GPS:TRIG:OUTP2:DEL 1600"  
 'sets a delay of 1600 chips for the signal on connector MARKER 2.

*RST value	Resolution	Options	SCPI
0	1 chip	B10/B11 and B13 K44 SOURce2 only with second option B9/B10/B11	Device-specific



[SOURce<[1]>:]BB:GPS:TRIGger:OUTPut:DELay:FIXed ON | OFF

The command restricts the marker delay setting range to the dynamic range. In this range the delay can be set without restarting the marker and signal. If a delay is entered in setting ON but is outside this range, the maximum possible delay is set and an error message is generated.

**Example:** "BB:GPS:TRIG:OUTP:DEL:FIX ON"  
'restricts the marker signal delay setting range to the dynamic range.

*RST value	Resolution	Options	SCPI
OFF	-	B10/B11 and B13 K44 SOURce2 only with second option B9/B10/B11	Device-specific

[SOURce<[1]>:]BB:GPS:TRIGger:OUTPut<[1]...4>:DELay:MAXimum

The command queries the maximum marker delay for setting :BB:GPS:TRIG:OUTP:DEL:FIX ON. The command is a query only and therefore has no \*RST value.

**Example:** "BB:GPS:TRIG:OUTP:DEL:FIX ON"  
'restricts the marker signal delay setting range to the dynamic range.

"BB:GPS:TRIG:OUTP:DEL:MAX?"  
'queries the maximum of the dynamic range.

Response: "2000"  
'the maximum for the marker delay setting is 2000 chips.

*RST value	Resolution	Options	SCPI
-	-	B10/B11 and B13 K44 SOURce2 only with second option B9/B10/B11	Device-specific

[SOURce<[1]>:]BB:GPS:TRIGger:OUTPut<[1]...4>:DELay:MINimum

The command queries the minimum marker delay for setting :BB:GPS:TRIGger:OUTPut:DELay:FIXed ON.

The command is a query only and therefore has no \*RST value.

**Example:** "BB:GPS:TRIG:OUTP:DEL:FIX ON"  
'restricts the marker signal delay setting range to the dynamic range.

"BB:GPS:TRIG:OUTP:DEL:MIN?"  
'queries the minimum of the dynamic range.

Response: "0"  
'the minimum for the marker delay setting is 0 chips.

*RST value	Resolution	Options	SCPI
-	-	B10/B11 and B13 K44 SOURce2 only with second option B9/B10/B11	Device-specific

**[SOURce<[1]|2>:]BB:GPS:TRIGger:OUTPut<[1]...4>:MODE**  
 NBIT | WORD | SFRame | PAGE | MESSage | PULSe | PATTern | RATio

The command defines the signal for the selected marker output.

- Parameter: NBIT**  
 A marker signal is generated for every navigation data bit (20460 C/A chips).
- WORD**  
 A marker signal is generated for every navigation data word (30 navigation bits).
- SFRame**  
 A marker signal is generated for every navigation subframe (corresponds to 10 words).
- PAGE**  
 A marker signal is generated for every navigation page (corresponds to 5 subframes).
- MESSage**  
 A marker signal is generated for every complete navigation message (corresponds to 25 pages).
- PULSe**  
 A pulsed marker signal is generated. The pulse frequency (= symbol rate/divider) is defined with the `SOUR:BB:GPS:TRIG:OUTP:PULSe:DIVider` command and can be queried with the `SOUR:BB:GPS:TRIG:OUTP:PULSe:FREQuency?` command.
- PATTern**  
 A marker signal is generated according to the user defined pattern (command `SOURce:BB:GPS:TRIGger:OUTPut:PATTern`).
- RATio**  
 A marker signal corresponding to the Time Off / Time On specifications in the commands `SOURce:BB:GPS:TRIGger:OUTPut:OFFT` and `SOURce:BB:GPS:TRIGger:OUTPut:ONT` is generated.

**Example:** `"BB:GPS:TRIG:OUTP2:MODE WORD"`  
 'selects the word marker signal on output MARKER 2. A marker signal is generated for every navigation data word (30 navigation bits, 20460 C/A chips each).

*RST value	Resolution	Options	SCPI
NBIT	-	B10/B11 and B13 K44 SOURce2 only with second option B9/B10/B11	Device-specific

**[SOURce<[1]|2>:]BB:GPS:TRIGger:OUTPut<[1]...4>:OFFTime** 1.. 2<sup>24</sup> - 1 (1..16 777 215) chips

The command sets the number of chips in a period (ON time + OFF time) during which the marker signal in setting SOURce:BB:GPS:TRIGger:OUTPut:MODE RATio on the marker outputs is OFF.

**Example:** "BB:GPS:TRIG:OUTP2:OFFT 200"  
'sets an OFF time of 200 chips for marker signal 2 on path A.

*RST value	Resolution	Options	SCPI
1	1	B10/B11 and B13 K44 SOURce2 only with second option B9/B10/B11	Device-specific

**[SOURce<[1]|2>:]BB:GPS:TRIGger:OUTPut<[1]...4>:ONTime** 1.. 2<sup>24</sup> - 1 (1..16 777 215) chips

The command sets the number of chips in a period (ON time + OFF time) during which the marker signal in setting SOURce:BB:GPS:TRIGger:OUTPut:MODE RATio on the marker outputs is ON.

**Example:** "BB:GPS:TRIG:OUTP2:ONT 200"  
'sets an ON time of 200 chips for marker 2 on path A.

*RST value	Resolution	Options	SCPI
1	1	B10/B11 and B13 K44 SOURce2 only with second option B9/B10/B11	Device-specific

**[SOURce<[1]|2>:]BB:GPS:TRIGger:OUTPut<[1]...4>:PATTern** #B0,1 ... #B111...1, 2

The command defines the bit pattern used to generate the marker signal in the setting SOURce:BB:GPS:TRIGger:OUTPut:MODE PATTern. 0 is marker off, 1 is marker on

**Example:** "BB:GPS:TRIG:OUTP2:PATT #B000000011111111,15"  
'sets a bit pattern.  
"BB:GPS:TRIG:OUTP2:MODE PATT"  
'activates the marker signal according to a bit pattern on output MARKER 2.

*RST value	Resolution	Options	SCPI
#B,1	-	B10/B11 and B13 K44 SOURce2 only with second option B9/B10/B11	Device-specific

[SOURce<[1]>:]BB:GPS:TRIGger:OUTPut<[1]...4>:PULSe:DIVider 2 ... 2^10

The command sets the divider for Pulse marker mode (SOUR:BB:GPS:TRIG:OUTP:MODE PULSe.). The resulting pulse frequency is derived by dividing the symbol rate by the divider.

**Example:** "BB:GPS:TRIG:OUTP2:PULS:DIV 2"  
'sets the divider to 2 for the path A marker signal on output MARKER 2.

"BB:GPS:TRIG:OUTP2:FREQ?"  
'queries the resulting pulse frequency of the marker signal.

Response: "511511.038"  
'the resulting pulse frequency is 511.511 kHz.

*RST value	Resolution	Options	SCPI
2	1	B10/B11 and B13 K44 SOURce2 only with second option B9/B10/B11	Device-specific

[SOURce<[1]>:]BB:GPS:TRIGger:OUTPut<[1]...4>:PULSe:FREQuency?

The command queries the pulse frequency of the pulsed marker signal in the setting SOURce:BB:GPS:TRIGger:OUTPut:MODE PULSe. The pulse frequency is derived by dividing the symbol rate by the divider.

The command is a query command and therefore has no \*RST value.

**Example:** "BB:GPS:TRIG:OUTP2:PULS:DIV 2"  
'sets the divider for the path A marker signal on output MARKER 2 to the value 2.

"BB:GPS:TRIG:OUTP2:MODE PULS"  
'enables the pulsed marker signal.

"BB:GPS:TRIG:OUTP2:PULS:FREQ?"  
'queries the pulse frequency of the marker signal.

Response: "511511.038"  
'the resulting pulse frequency is 511.511 kHz.

*RST value	Resolution	Options	SCPI
-	-	B10/B11 and B13 K44 SOURce2 only with second option B9/B10/B11	Device-specific

**[SOURce<[1]|2>:]BB:GPS:TRIGger:RMODE**

The command queries the current status of signal generation for all trigger modes with GPS modulation on.

The command is a query command and therefore has no \*RST value.

**Parameter: RUN**

the signal is generated. A trigger event occurred in the triggered mode.

**STOP**

the signal is not generated. A trigger event did not occur in the triggered modes, or signal generation was stopped by the command

:BB:GPS:TRIG:ARM:EXECute (armed trigger modes only).

**Example:**

SOUR2:BB:GPS:TRIG:MODE ARET"

'selects the Armed\_Retrigger mode.

SOUR2:BB:GPS:TRIG:SOUR EXT"

'sets external triggering via the TRIGGER 1 connector for path B of a two-path instrument.

SOUR2:BB:GPS:TRIG:RMODE?"

'queries the current status of signal generation.

Response: "RUN"

'the signal is generated, an external trigger was executed.

*RST value	Resolution	Options	SCPI
-	-	B10/B11 and B13 K44 SOURce2 only with second option B9/B10/B11	Device-specific

**[SOURce<[1]|2>:]BB:GPS:TRIGger:SLENgth 1 ... (2^32-1) chips**

The command defines the length of the signal sequence to be output in the **Single** trigger mode (SOUR:BB:GPS:SEQ SING). The input is made in terms of chips.

It is possible to output deliberately just part of the frame, an exact sequence of the frame, or a defined number of repetitions of the frame.

**Example:**

SOUR2:BB:GPS:SEQ SING"

'sets trigger mode Single.

SOUR2:BB:GPS:TRIG:SLEN 200"

'sets a sequence length of 200 chips. The first 200 chips of the current frame will be output after the next trigger event.

*RST value	Resolution	Options	SCPI
32 768 chips	1 chip	B10/B11 and B13 K44 SOURce2 only with second option B9/B10/B11	Device-specific

[SOURce<[1]]2>:]BB:GPS:TRIGger:SLUNit SFRame | CHIP | NBIT | CNMessage

The command defines the unit for the entry of the length of the signal sequence (SOUR:BB:GPS:TRIG:SLEN) to be output in the **Single** trigger mode (SOUR:BB:GPS:SEQ SING).

- Parameter:**     **SFRame**  
Unit subframe. A single subframe is generated after a trigger event.
- CHIP**  
Unit Chip. A single chip is generated after a trigger event.
- NBIT**  
Unit Navigation Bit. A single Navigation Bit is generated after a trigger event.
- CNMessage**  
Unit Complete Navigation Message. A single Complete Navigation Message is generated after a trigger event.

**Example:**       "BB:GPS:SEQ SING"  
                  'sets trigger mode Single.

                  "BB:GPS:TRIG:SLUN SFR"  
                  'sets unit Subframe for the entry of signal duration.

                  "BB:GPS:TRIG:SLEN 2"  
                  'sets a signal duration of 2 subframes. The current subframe will be output twice after the next trigger event.

*RST value	Resolution	Options	SCPI
CHIP	-	B10/B11 and B13 K44 SOURce2 only with second option B9/B10/B11	

[SOURce<[1]|2>:]BB:GPS:TRIGger:SOURce INTernal | EXTernal | BEXTernal | OBASeband

The command selects the trigger source.

**Parameter:**

**INTernal**

Triggering is executed by means of the Trigger command  
 SOURce<[1]|2>:BB:GPS:TRIGger:EXECute or \*TRG in the case of  
 remote control and by means of **Execute Trigger** in the case of manual  
 operation.

Triggering is executed by means of the Trigger command  
 SOURce:BB:GPS:TRIGger:EXECute or \*TRG in the case of remote control  
 and by means of **Execute Trigger** in the case of manual operation.

Triggering is executed by means of the Trigger command  
 SOURce:BB:GPS:TRIGger:EXECute or \*TRG in the case of remote control  
 and by means of **Execute Trigger** in the case of manual operation.

**EXTernal**

Triggering is executed by means of the signal on the TRIGGER 1 connector.

**BEXTernal**

Triggering is executed by means of the signal on the TRIGGER 2 connector.

**OBASeband**

Triggering is executed by means of the trigger signal from the second path  
 (two-path instruments only).

**Example:**

SOUR2:BB:GPS:TRIG:SING"

'selects a trigger mode that requires a trigger.

SOUR2:BB:GPS:TRIG:SOUR EXT"

'sets external triggering via the TRIGGER 1 connector for path B of a two-path  
 instrument.

*RST value	Resolution	Options	SCPI
INTernal	-	B10/B11 and B13 K44 SOURce2 only with second option B9/B10/B11	Device-specific

## SOURce:GPS - Satellite Signal Settings

The SOURce:BB:GPS:SATellite and SOURce:BB:GPS:NAVigation systems contain commands for setting the characteristics of the satellite signals.

Command	Parameters	Default unit	Comments
[SOURce<[1] 2>:]BB:GPS:NAVigation:ALManac	<file name>		
[SOURce<[1] 2>:]BB:GPS:NAVigation:ALManac:BEgin:DAY	1 ... 31		
[SOURce<[1] 2>:]BB:GPS:NAVigation:ALManac:BEgin:MONTH	1 ... 12		
[SOURce<[1] 2>:]BB:GPS:NAVigation:ALManac:BEgin:WNUMBER	1 ... 5		
[SOURce<[1] 2>:]BB:GPS:NAVigation:ALManac:BEgin:YEAR	-9999 ... 9999		
[SOURce<[1] 2>:]BB:GPS:NAVigation:ALManac:END:DAY	1 ... 31		
[SOURce<[1] 2>:]BB:GPS:NAVigation:ALManac:END:MONTH	1 ... 12		
[SOURce<[1] 2>:]BB:GPS:NAVigation:ALManac:END:YEAR	-9999 ... 9999		
[SOURce<[1] 2>:]BB:GPS:NAVigation:ALManac:TOEPheris			Query only
[SOURce<[1] 2>:]BB:GPS:NAVigation:DATA	ZERO   ONE   PATtern   PN9   PN11   PN15   PN16   PN20   PN21   PN23   DLISt   RNData		
[SOURce<[1] 2>:]BB:GPS:NAVigation:DATA:DSElect	<dlist_name>		
[SOURce<[1] 2>:]BB:GPS:NAVigation:DATA:PATtern	#B0,1...B11..1,64		
[SOURce<[1] 2>:]BB:GPS:SATellite<1 2 3 4>:CACRate			Query only
[SOURce<[1] 2>:]BB:GPS:SATellite<1 2 3 4>:DSHift	-100.0 kHz ... 100.0 kHz	Hz	
[SOURce<[1] 2>:]BB:GPS:SATellite<1 2 3 4>:FREQency			Query only
[SOURce<[1] 2>:]BB:GPS:SATellite<1 2 3 4>:PCRate			Query only
[SOURce<[1] 2>:]BB:GPS:SATellite<1 2 3 4>:POWER	-10.0 dB ... 10.0 dB	dB	
[SOURce<[1] 2>:]BB:GPS:SATellite<1 2 3 4>:RCODE	CACode		
[SOURce<[1] 2>:]BB:GPS:SATellite<1 2 3 4>:STATE	ON   OFF		
[SOURce<[1] 2>:]BB:GPS:SATellite<1 2 3 4>:TSHips	0 ... 10 000 000		
[SOURce<[1] 2>:]BB:GPS:SATellite<1 2 3 4>:TSSeconds		s	Query only
[SOURce<[1] 2>:]BB:GPS:SATellite<1 2 3 4>:VID	0 ... 37		



**[SOURce<[1]]2>:]BB:GPS:NAVigation:ALManac <text file name>**

The command selects the almanac providing the navigation information). Current almanac data can be downloaded via the Internet. The files are provided as text files (\*.txt).

The directory applicable to the following command is defined with the command MMEMory:CDIR. To access the files in this directory, only the file name is required, without the path and the file extension.

**Example:** "MMEM:CDIR 'D:\Lists\gps'"  
 'selects the directory for the almanac files.  
 "BB:GPS:NAV:ALM 'SEM269'"  
 'the file 'SEM269' is used for retrieving navigation information.

*RST value	Resolution	Options	SCPI
-	-	B10/B11 and B13 K44 SOURce2 only with second option B9/B10/B11	Device-specific

**[SOURce<[1]]2>:]BB:GPS:NAVigation:ALManac:BEGin:DAY?**

The command queries the start day of the week in which the almanac was published. The command is only available if data source Real Navigation Data is selected (SOURce:BB:GPS:NAVigation:DATA RND). The almanac is loaded with command SOURce:BB:GPS:NAVigation:ALManac.

The command is a query command and therefore has no \*RST value.

**Example:** "BB:GPS:NAV:ALM:BEG:DAY?"  
 'queries the start day of the GPS week.  
 Response: "12"  
 'the GPS week starts on the 12<sup>th</sup> of the month.

*RST value	Resolution	Options	SCPI
-	-	B10/B11 and B13 K44 SOURce2 only with second option B9/B10/B11	Device-specific

**[SOURce<[1]|2>:]BB:GPS:NAVigation:ALManac:BEgin:MONTh?**

The command queries the start month of the week in which the almanac was published. The command is only available if data source Real Navigation Data is selected (SOURce:BB:GPS:NAVigation:DATA RND). The almanac is loaded with command SOURce:BB:GPS:NAVigation:ALMananc.

The command is a query command and therefore has no \*RST value.

**Example:** "BB:GPS:NAV:ALM:BEG:MONT?"  
'queries the start month of the GPS week.

Response: "4"  
'the week starts in April.

*RST value	Resolution	Options	SCPI
-	-	B10/B11 and B13 K44 SOURce2 only with second option B9/B10/B11	Device-specific

**[SOURce<[1]|2>:]BB:GPS:NAVigation:ALManac:BEgin:WNUMber?**

The command queries the GPS week number of the almanac. The command is only available if data source Real Navigation Data is selected (SOURce:BB:GPS:NAVigation:DATA RND). The almanac is loaded with command SOURce:BB:GPS:NAVigation:ALMananc.

The command is a query command and therefore has no \*RST value.

**Example:** "BB:GPS:NAV:ALM:BEG:WNUM?"  
'queries the GPS week number of almanac.

Response: "1233"  
'the week number is 1233.

*RST value	Resolution	Options	SCPI
-	-	B10/B11 and B13 K44 SOURce2 only with second option B9/B10/B11	Device-specific

**[SOURce<[1]>:]BB:GPS:NAVigation:ALManac:BEgin:YEAR?**

The command queries the year of the week in which the almanac was published. The command is only available if data source Real Navigation Data is selected (SOURce:BB:GPS:NAVigation:DATA RND). The almanac is loaded with command SOURce:BB:GPS:NAVigation:ALMananc.

The command is a query command and therefore has no \*RST value.

**Example:** "BB:GPS:NAV:ALM:BEG:YEAR?"  
'queries the year of the GPS week.

Response: "2005"  
'the year is 2005.

*RST value	Resolution	Options	SCPI
-	-	B10/B11 and B13 K44 SOURce2 only with second option B9/B10/B11	Device-specific

**[SOURce<[1]>:]BB:GPS:NAVigation:ALManac:END:DAY?**

The command queries the final day of the week in which the almanac was published. The command is only available if data source Real Navigation Data is selected (SOURce:BB:GPS:NAVigation:DATA RND). The almanac is loaded with command SOURce:BB:GPS:NAVigation:ALMananc.

The command is a query command and therefore has no \*RST value.

**Example:** "BB:GPS:NAV:ALM:END:DAY?"  
'queries the final day of the GPS week.

Response: "19"  
'the GPS week ends on the 19<sup>th</sup> of the month.

*RST value	Resolution	Options	SCPI
-	-	B10/B11 and B13 K44 SOURce2 only with second option B9/B10/B11	Device-specific

**[SOURce<[1]>:]BB:GPS:NAVigation:ALManac:END:MONTH?**

The command queries the final month of the week in which the almanac was published. The command is only available if data source Real Navigation Data is selected (SOURce:BB:GPS:NAVigation:DATA RND). The almanac is loaded with command SOURce:BB:GPS:NAVigation:ALMananc.

The command is a query command and therefore has no \*RST value.

**Example:** "BB:GPS:NAV:ALM:END:MONTH?"  
'queries the final month of the GPS week.

Response: "4"  
'the GPS week ends in April.

*RST value	Resolution	Options	SCPI
-	-	B10/B11 and B13 K44 SOURce2 only with second option B9/B10/B11	Device-specific

**[SOURce<[1]>:]BB:GPS:NAVigation:ALManac:END:YEAR?**

The command queries the year of the week in which the almanac was published. The command is only available if data source Real Navigation Data is selected (SOURce:BB:GPS:NAVigation:DATA RND). The almanac is loaded with command SOURce:BB:GPS:NAVigation:ALMananc.

The command is a query command and therefore has no \*RST value.

**Example:** "BB:GPS:NAV:ALM:END:YEAR?"  
'queries the year of the GPS week.

Response: "2005"  
'the year is 2005.

*RST value	Resolution	Options	SCPI
-	-	B10/B11 and B13 K44 SOURce2 only with second option B9/B10/B11	Device-specific

**[SOURce<[1]]2>:]BB:GPS:NAVigation:ALManac:TOEPheris?**

The command queries the time of ephemeris, i.e the exact time in seconds to which the navigation data refers. The command is only available if data source Real Navigation Data is selected (SOURce:BB:GPS:NAVigation:DATA RND). The almanac is loaded with command SOURce:BB:GPS:NAVigation:ALMananc.

The command is a query command and therefore has no \*RST value.

**Example:** "BB:GPS:NAV:ALM:TOEP?"  
'queries the time of ephemeris.

Response: "589824"  
'the value is returned in seconds. Counting starts at 0.00 a.m. on sunday of the GPS week.

*RST value	Resolution	Options	SCPI
-	-	B10/B11 and B13 K44 SOURce2 only with second option B9/B10/B11	Device-specific

**[SOURce<[1]]2>:]BB:GPS:NAVigation:DATA**

RNDData | PN9 | PN15 | PN16 | PN20 | PN21 | PN23 | DLISt | ZERO | ONE | PATTErn

The command determines the data source for the navigation information.

**Parameters:** **RNDData**  
Real navigation data provided by an almanac file is used. The file is loaded with command SOURce:BB:GPS:NAVigation:ALMananc.

**DLISt**  
A data list is used. The data list is selected with the command :BB:GPS:NAVigation:DATA:DSElect.

**PNxx**  
The pseudo-random sequence generator is used as the data source. Different random sequence lengths can be selected.

**ZERO | ONE**  
Internal 0 and 1 data is used.

**PATTErn**  
Internal data is used The bit pattern for the data is defined by the command :BB:GPS:NAVigation:DATA:PATTErn

**Example:** "BB:GPS:NAV:DATA PATT"  
'selects as the data source for the data fields of burst 0, the bit pattern defined with the following command.

"BB:GPS:NAV:DATA:PATT #H3F,8"  
'defines the bit pattern.

*RST value	Resolution	Options	SCPI
RNDData	-	B10/B11 and B13 K44 SOURce2 only with second option B9/B10/B11	Device-specific

[SOURce<[1]|2>:]BB:GPS:NAVigation:DATA:DSElect <data list name>

The command selects the data list for the DLIS data source selection.

The lists are stored as files with the fixed file extensions \*.dm\_iqd in a directory of the user's choice. The directory applicable to the following commands is defined with the command MMEMoRY:CDIR. To access the files in this directory, you only have to give the file name, without the path and the file extension.

**Example:** "BB:GPS:NAV:DATA DLIS"  
 'selects the Data Lists data source.  
 "MMEM:CDIR 'D:\Lists\DM\IqData'"  
 'selects the directory for the data lists.  
 "BB:GPS:NAV:DATA:DLIS 'GPS\_list1'"  
 'selects file 'GPS\_list1' as the data source. This file must be in the directory D:\Lists\DM\IqData and have the file extension \*.dm\_iqd.

*RST value	Resolution	Options	SCPI
-	-	B10/B11 and B13 K44 SOURce2 only with second option B9/B10/B11	Device-specific

[SOURce<[1]|2>:]BB:GPS:NAVigation:DATA:PATtern

#B0,1... #B111..1,64

The command determines the bit pattern for the PATtern selection. The maximum length is 64 bits.

**Example:** "BB:GPS:NAV:DATA:PATT #H3F,8"  
 'defines the bit pattern.

*RST value	Resolution	Options	SCPI
0	-	B10/B11 and B13 K44 SOURce2 only with second option B9/B10/B11	Device-specific

[SOURce<[1]|2>:]BB:GPS:NAVigation:SIMulation[:BEGin]:DAY 1... 31

The command sets the day for the simulation in Greenwich Mean Time. The command is only available if data source Real Navigation Data is selected (SOURce:BB:GPS:NAV:DATA RND).

**Example:** "BB:GPS:NAV:SIM:DAY 12"  
 'sets day 12 for the exact time of the simulation.

*RST value	Resolution	Options	SCPI
10	-	B10/B11 and B13 K44 SOURce2 only with second option B9/B10/B11	Device-specific

**[SOURce<[1]>:]BB:GPS:NAVigation:SIMulation[:BEGin]:HOUR 0 ... 11**

The command sets the hour for the simulation in Greenwich Mean Time. The command is only available if data source Real Navigation Data is selected (SOURce:BB:GPS:NAV:DATA RND).

**Example:** "BB:GPS:NAV:SIM:HOUR 4"  
'set hour 4 for the exact time of the simulation.

*RST value	Resolution	Options	SCPI
0	-	B10/B11 and B13 K44 SOURce2 only with second option B9/B10/B11	Device-specific

**[SOURce<[1]>:]BB:GPS:NAVigation:SIMulation[:BEGin]:MINute 0 ... 59**

The command sets the minute for the simulation in Greenwich Mean Time. The command is only available if data source Real Navigation Data is selected (SOURce:BB:GPS:NAV:DATA RND).

**Example:** "BB:GPS:NAV:SIM:MIN 4"  
'set minute 4 for the exact time of the simulation.

*RST value	Resolution	Options	SCPI
0	-	B10/B11 and B13 K44 SOURce2 only with second option B9/B10/B11	Device-specific

**[SOURce<[1]>:]BB:GPS:NAVigation:SIMulation[:BEGin]:MONTH 1 ... 12**

The command sets the month for the simulation in Greenwich Mean Time. The command is only available if data source Real Navigation Data is selected (SOURce:BB:GPS:NAV:DATA RND).

**Example:** "BB:GPS:NAV:SIM:MONT 4"  
'set April for the exact time of the simulation.

*RST value	Resolution	Options	SCPI
10	-	B10/B11 and B13 K44 SOURce2 only with second option B9/B10/B11	Device-specific

**[SOURce<[1]>:]BB:GPS:NAVigation:SIMulation[:BEGin]:SECond 0 ... 59**

The command sets the second for the simulation in Greenwich Mean Time. The command is only available if data source Real Navigation Data is selected (SOURce:BB:GPS:NAV:DATA RND).

**Example:** "BB:GPS:NAV:SIM:SEC 23"  
'sets the second 23 for the exact time of the simulation.

*RST value	Resolution	Options	SCPI
0	-	B10/B11 and B13 K44 SOURce2 only with second option B9/B10/B11	Device-specific

**[SOURce<[1]|2>:]BB:GPS:NAVigation:SIMulation[:BEGin]:YEAR -9999 ... 9999**

The command sets the year for the simulation.. The command is only available if data source Real Navigation Data is selected (SOURce:BB:GPS:NAV:DATA RND).

**Example:** "BB:GPS:NAV:SIM:YEAR 2005"  
'sets the year 2005 for the exact time of the simulation.

*RST value	Resolution	Options	SCPI
2004	-	B10/B11 and B13 K44 SOURce2 only with second option B9/B10/B11	Device-specific

**[SOURce<[1]|2>:]BB:GPS:SATellite<1|2|3|4>CACRate?**

The command queries the currently valid values for the chip rate of the C/A code.The chip rate depends on the set doppler shift.

The command is a query command and therefore has no \*RST value.

**Example:** "BB:GPS:SAT4:CACR?"  
'queries the chip rate of the C/A code of satellite 4.

Response: "1023022.077"  
'the chip rate is 1. 023022 08 MHz.

*RST value	Resolution	Options	SCPI
-		B10/B11 and B13 K44 SOURce2 only with second option B9/B10/B11	Device-specific

**[SOURce<[1]|2>:]BB:GPS:SATellite<1|2|3|4>DSHift -100 kHz ... 100 kHz**

The command sets the doppler shift of the simulated signal of the selected satellite. The relevant change to the chip rate of the C/A code is carried out automatically. The currently valid values for Doppler-shifted carrier frequency and chip rates are queried with commands

SOURce:BB:GPS:SATellite:CACRate, SOURce:BB:GPS:SATellite:PCRate and SOURce:BB:GPS:SATellite:FREquency

**Example:** "BB:GPS:SAT2:DSH 5 kHz"  
'sets a doppler shift of 5 kHz for satellite 2.

*RST value	Resolution	Options	SCPI
0	0.01 Hz	B10/B11 and B13 K44 SOURce2 only with second option B9/B10/B11	Device-specific



**[SOURce<[1]|2>:]BB:GPS:SATellite<1|2|3|4>CACRate?**

The command queries the resulting C/A chip rate.

The command is a query command and therefore has no \*RST value.

**Example:** "BB:GPS:SAT4:CACR?"  
'queries the resulting C/A chip rate of satellite 4.

Response: "1023000.0067142857"  
'the resulting C/A chip rate is 11.023 MHz.

*RST value	Resolution	Options	SCPI
-		B10/B11 and B13 K44 SOURce2 only with second option B9/B10/B11	Device-specific

**[SOURce<[1]|2>:]BB:GPS:SATellite<1|2|3|4>FREQUency?**

The command queries the currently valid value for the doppler-shifted carrier frequency.

The command is a query command and therefore has no \*RST value.

**Example:** "BB:GPS:SAT4:FREQ?"  
'queries the resulting carrier frequency of satellite 4.

Response: "1575421111"  
'the resulting carrier frequency is 1.57542 GHz.

*RST value	Resolution	Options	SCPI
-		B10/B11 and B13 K44 SOURce2 only with second option B9/B10/B11	Device-specific

**[SOURce<[1]|2>:]BB:GPS:SATellite<1|2|3|4>PCRate?**

The command queries the currently valid value for the resulting P-chip rate.

The command is a query command and therefore has no \*RST value.

**Example:** "BB:GPS:SAT4:PCR?"  
'queries the resulting P-chip rate of satellite 4.

Response: "10230007.214285715"  
'the resulting P-chip rate is 10.230007 MHz.

*RST value	Resolution	Options	SCPI
-		B10/B11 and B13 K44 SOURce2 only with second option B9/B10/B11	Device-specific

[SOURce<[1]|2>:]BB:GPS:SATellite<1|2|3|4>:POWER -10 dB ... +10 dB

The command sets the power offset of the satellite.

**Example:** "BB:GPS:SAT4:POW -2 dB"  
'sets a power offset of 2 dB.

*RST value	Resolution	Options	SCPI
0 dB	0.1 dB	B10/B11 and B13 K44 SOURce2 only with second option B9/B10/B11	Device-specific

[SOURce<[1]|2>:]BB:GPS:SATellite<1|2|3|4>:RCODE?

The command queries the ranging code.

The command is a query command and therefore has no \*RST value.

**Example:** "BB:GPS:SAT:RCOD?"  
'queries the ranging code.

Response: "CAC"  
'the C/A code (f<sub>ca</sub> = 1.023 MHz) is used. It is provided for civilian purposes.

*RST value	Resolution	Options	SCPI
0	-	B10/B11 and B13 K44 SOURce2 only with second option B9/B10/B11	Device-specific

[SOURce<[1]|2>:]BB:GPS:SATellite<1|2|3|4>:STATe ON | OFF

The command enables/disables generation of the signal of the selected satellite.

**Example:** "BB:GPS:SAT4:STAT ON"  
'enables generation of the signal of satellite 4

*RST value	Resolution	Options	SCPI
SAT1: ON SAT<2 3 4>: OFF		B10/B11 and B13 K44 SOURce2 only with second option B9/B10/B11	Device-specific

[SOURce<[1]|2>:]BB:GPS:SATellite<1|2|3|4>:TSCHips 0 ...10 000 000

The command sets a delay of the selected satellite relative to the other satellites.

**Example:** "BB:GPS:SAT4:TSCH 100232"  
'sets a time shift of 100232 .

*RST value	Resolution	Options	SCPI
0		B10/B11 and B13 K44 SOURce2 only with second option B9/B10/B11	Device-specific

[SOURce<[1]|2>:]BB:GPS:SATellite<1|2|3|4>:TSSSeconds?

The command queries the time shift of the code sequence in seconds.

The command is a query command and therefore has no \*RST value.

**Example:** "BB:GPS:SAT4:TSS?"  
'queries the time shift in seconds.

Response: "0.00979"  
'the time shift is 9.799 ms.

*RST value	Resolution	Options	SCPI
		B10/B11 and B13 K44 SOURce2 only with second option B9/B10/B11	Device-specific

[SOURce<[1]|2>:]BB:GPS:SATellite<1|2|3|4>:VID 1 ... 37

The command sets the id of the satellite to be simulated. This value is used to generate the corresponding C/A code. If **Real Navigation Data** is used, only the valid Ids which are listed in the almanac are settable. For arbitrary data, all Ids can be selected.

**Example:** "BB:GPS:SAT2:VID 4"  
'sets id 4 for the second satellite.

*RST value	Resolution	Options	SCPI
SAT1: 1 SAT2: 2 SAT3: 3 SAT4: 4	-	B10/B11 and B13 K44 SOURce2 only with second option B9/B10/B11	Device-specific

## SOURce:BB:GSM Subsystem

This subsystem contains the commands for setting the GSM/EDGE standards.

### Note:

*The R&S Vector Signal Generator can be used to define multiframe signals. This requires the inclusion of the keyword FRAME in the commands concerned. However, this keyword is optional in the case of single-frame signals. When the keyword is not specified the commands are compatible with the corresponding commands in the R&S SMIQ generator family (see also the list comparing R&S SMATE/R&S SMIQ commands).*

The numeric suffix to SOURce distinguishes between multicarrier generation for path A and path B in the case of two-path instruments:

SOURce<1> = path A

SOURce2 = path B

The keyword SOURce is optional in the case of commands for path A and can be omitted. For path B the command must contain the keyword with suffix 2.

In Frame (Double) mode (SOURce:BB:GSM:MODE DOUBle) the suffix to FRAME defines the frame to which the setting applies. In Frame (Single) mode the keyword FRAME is ignored and can be omitted.

The suffix to SLOT defines the slot to which the setting applies. The 8 slots of which a frame is composed can be selected.

### Important:

*In case of remote control, suffix counting for slots corresponds to the suffix counting with GSM (slot 0 to slot 7). SCPI prescribes that suffix 1 is the default state and used when no specific suffix is specified. Therefore, slot 1 (and not slot 0) is selected when no suffix is specified.*

When burst type HALF is selected, the suffix to USER defines the half rate user to which the setting applies. For all other burst types the keyword USER is ignored and can be omitted.

Command	Parameter	Default unit	Note
[SOURce<[1]2>:]BB:GSM:CLOCK:DIVider	1 ... 65536		
[SOURce<[1]2>:]BB:GSM:CLOCK:MODE	BIT   SYMBol   MSYMBol   FSYMBol		
[SOURce<[1]2>:]BB:GSM:CLOCK:MULTiplier	0 ... 64		
[SOURce<[1]2>:]BB:GSM:CLOCK:SOURce	INTernal   EXTernal		
[SOURce<[1]2>:]BB:GSM:EDGE:FORMat?			
[SOURce<[1]2>:]BB:GSM:FILTer:EDGE:TYPE	LGAuss		
[SOURce<[1]2>:]BB:GSM:FILTer:PARAmeter	0.15 ... 2.5		
[SOURce<[1]2>:]BB:GSM:FILTer:TYPE	GAUSSs		
[SOURce<[1]2>:]BB:GSM:FORMat	MSK   FSK2		
[SOURce<[1]2>:]BB:GSM[:FRAME<[1]2>:]MULTiSlot<0[1]...7>:COUNT	1 ... 8		

Command	Parameter	Default unit	Note
[SOURCE<[1]>:]BB:GSM[:FRAME<[1]>]:MULTIslot<0[[1]...7>:STATe	ON   OFF		
[SOURCE<[1]>:]BB:GSM[:FRAME<[1]>]:PREDEfined:CATalog?			Query only
[SOURCE<[1]>:]BB:GSM[:FRAME<[1]>]:PREDEfined:LOAD	"slot_name"		No query
[SOURCE<[1]>:]BB:GSM:FRAME:REPetitions	0 ... 500		
[SOURCE<[1]>:]BB:GSM[:FRAME<[1]>]:SLOT<0[[1]...7>:TYPE	NORMAL   HALF   EDGE   SYNC   FCORrection   DUMMY   ACCess   ADATa   AEDge		
[SOURCE<[1]>:]BB:GSM[:FRAME<[1]>]:SLOT<0[[1]...7>[:USER<[1]>]:ATTenuation	A1 ... A7		
[SOURCE<[1]>:]BB:GSM[:FRAME<[1]>]:SLOT<0[[1]...7>[:USER<[1]>]:DUMMY:MIXed:PATtern			Query only
[SOURCE<[1]>:]BB:GSM[:FRAME<[1]>]:SLOT<0[[1]...7>[:USER<[1]>]:ETSC	STANDARD   CTS   COMPact   USER		
[SOURCE<[1]>:]BB:GSM[:FRAME<[1]>]:SLOT<0[[1]...7>[:USER<[1]>]:FCORrection:FIXed	STANDARD   COMPact   USER		
[SOURCE<[1]>:]BB:GSM[:FRAME<[1]>]:SLOT<0[[1]...7>[:USER<[1]>]:FCORrection:FIXed:PATtern	#B000...,142 .... #B111...,142		
[SOURCE<[1]>:]BB:GSM[:FRAME<[1]>]:SLOT<0[[1]...7>[:USER<[1]>]:LEVel	ATT   FULL   OFF		
[SOURCE<[1]>:]BB:GSM[:FRAME<[1]>]:SLOT<0[[1]...7>[:USER<[1]>]:PREDEfined:CATalog?			Query only
[SOURCE<[1]>:]BB:GSM[:FRAME<[1]>]:SLOT<0[[1]...7>[:USER<[1]>]:PREDEfined:LOAD	"slot_name"		No query
[SOURCE<[1]>:]BB:GSM[:FRAME<[1]>]:SLOT<0[[1]...7>[:USER<[1]>]:SFLag	0   1		
[SOURCE<[1]>:]BB:GSM[:FRAME<[1]>]:SLOT<0[[1]...7>[:USER<[1]>]:SFLag:USE	ON   OFF		
[SOURCE<[1]>:]BB:GSM[:FRAME<[1]>]:SLOT<0[[1]...7>[:USER<[1]>][:SOURCE]:DATA	PN9   PN11   PN15   PN16   PN16I   PN20   PN21   PN23   DLISt   ZERO   ONE   PATtern		
[SOURCE<[1]>:]BB:GSM[:FRAME<[1]>]:SLOT<0[[1]...7>[:USER<[1]>][:SOURCE]:DATA:DLISt	<dlist_name>		
[SOURCE<[1]>:]BB:GSM[:FRAME<[1]>]:SLOT<0[[1]...7>[:USER<[1]>][:SOURCE]:DATA:DLISt:CATalog?			Query only
[SOURCE<[1]>:]BB:GSM[:FRAME<[1]>]:SLOT<0[[1]...7>[:USER<[1]>][:SOURCE]:DATA:PATtern	#B0,1...#B111...,64		
[SOURCE<[1]>:]BB:GSM[:FRAME<[1]>]:SLOT<0[[1]...7>[:USER<[1]>][:SOURCE]:TSC:USER	#B0,1...#B111...,26/78		
[SOURCE<[1]>:]BB:GSM[:FRAME<[1]>]:SLOT<0[[1]...7>[:USER<[1]>]:SYNC:SElect	T0   T1   USER		
[SOURCE<[1]>:]BB:GSM[:FRAME<[1]>]:SLOT<0[[1]...7>[:USER<[1]>]:SYNC:USER	#B0,1...#B111...,41		
[SOURCE<[1]>:]BB:GSM[:FRAME<[1]>]:SLOT<0[[1]...7>[:USER<[1]>]:TSC:SElect	T0 ... T7   USER		
[SOURCE<[1]>:]BB:GSM[:FRAME<[1]>]:SLOT<0[[1]...7>[:USER<[1]>]:ULISt:CATalog?			Query only
[SOURCE<[1]>:]BB:GSM[:FRAME<[1]>]:SLOT<0[[1]...7>[:USER<[1]>]:ULISt:DELeTe	"slot_name"		No query
[SOURCE<[1]>:]BB:GSM[:FRAME<[1]>]:SLOT<0[[1]...7>[:USER<[1]>]:ULISt:LOAD	"slot_name"		No query

Command	Parameter	Default unit	Note
[SOURce<[1] 2>:]BB:GSM[:FRAMe<[1] 2>]:SLOT<0 [1]...7>[:USER<[1] 2>]:ULISt:StORe	"slot_name"		No query
[SOURce<[1] 2>:]BB:GSM:FRAMe:ULISt:CATalog?			Query only
[SOURce<[1] 2>:]BB:GSM:FRAMe:ULISt:DELeTe	"frame_name"		No query
[SOURce<[1] 2>:]BB:GSM:FRAMe:ULISt:LOAD	"frame_name"		No query
[SOURce<[1] 2>:]BB:GSM:FRAMe:ULISt:StORe	"frame_name"		No query
[SOURce<[1] 2>:]BB:GSM:FSK:DEViation	0.1x f(symb) ... 1.5 xf(symb)	Hz	
[SOURce<[1] 2>:]BB:GSM:ISLength	ON   OFF		
[SOURce<[1] 2>:]BB:GSM:MODE	UNFRamed   SINGLE   DOUBle   MULTIframe		
[SOURce<[1] 2>:]BB:GSM:PRAMp:BBONly[:STATe]	ON   OFF		
[SOURce<[1] 2>:]BB:GSM:PRAMp:FDELay	-9 ... +9 Symbols		
[SOURce<[1] 2>:]BB:GSM:PRAMp:RDELay	-9 ... +9 Symbols		
[SOURce<[1] 2>:]BB:GSM:PRAMp:SHAPE	LINear   COSine		
[SOURce<[1] 2>:]BB:GSM:PRAMp:TIME	0.3 ... 16 Symbols		
[SOURce<[1] 2>:]BB:GSM:PRESet			No query
[SOURce<[1] 2>:]BB:GSM:SATTenuation<n>	0 ... 60 dB	dB	
[SOURce<[1] 2>:]BB:GSM:SETTing:CATalog?			Query only
[SOURce<[1] 2>:]BB:GSM:SETTing:DELeTe	<file_name>		
[SOURce<[1] 2>:]BB:GSM:SETTing:LOAD	<file_name>		
[SOURce<[1] 2>:]BB:GSM:SETTing:StORe	<file_name>		
[SOURce<[1] 2>:]BB:GSM:SEQUence	AUTO   RETRigger   AAUTO   ARETrigger   SINGLE		
[SOURce<[1] 2>:]BB:GSM:SMODE	GSM   EDGE		
[SOURce<[1] 2>:]BB:GSM:SRATE	400 Hz ... 25 MHz	Hz	
[SOURce<[1] 2>:]BB:GSM:STATe	ON   OFF		
[SOURce<[1] 2>:]BB:GSM:TRIGger:ARM:EXECute			No query
[SOURce<[1] 2>:]BB:GSM:TRIGger:EXECute			No query
[SOURce<[1] 2>:]BB:GSM:TRIGger:EXTernal:CLOCK:DELay	0 ... 2 <sup>32</sup> -1 Symbols		
[SOURce<[1] 2>:]BB:GSM:TRIGger:EXTernal:CLOCK:INHibit	0 ... 2 <sup>32</sup> -1 Symbols		
[SOURce<[1] 2>:]BB:GSM:TRIGger[:EXTernal<[1] 2>]:DELay	0 ... 2 <sup>32</sup> -1 Symbols		
[SOURce<[1] 2>:]BB:GSM:TRIGger[:EXTernal<[1] 2>]:INHibit	0 ... 2 <sup>32</sup> -1 Symbols		
[SOURce<[1] 2>:]BB:GSM:TRIGger:OBASeband:DELay	0 ... 2 <sup>32</sup> -1	Hz	
[SOURce<[1] 2>:]BB:GSM:TRIGger:OBASeband:INHibit	0 ... 2 <sup>32</sup> -1	Hz	
[SOURce<[1] 2>:]BB:GSM:TRIGger:OUTPut<[1]...4>:DELay	0 ... 1249 Symbols		
[SOURce<[1] 2>:]BB:GSM:TRIGger:OUTPut:DELay:FIXed	ON   OFF	Hz	
[SOURce<[1] 2>:]BB:GSM:TRIGger:OUTPut<[1]...4>:DELay:MAXimum?			Query only
[SOURce<[1] 2>:]BB:GSM:TRIGger:OUTPut<[1]...4>:DELay:MINimum?			Query only

Command	Parameter	Default unit	Note
[SOURce<[1]>:]BB:GSM:TRIGger:OUTPut<[1]...4>MODE	SDEF   FRAMe   SLOt   PULSe   PATTeRn   RATIo		
[SOURce<[1]>:]BB:GSM:TRIGger:OUTPut<[1]...4>OFFTime	1 ... 2 <sup>24</sup> -1		
[SOURce<[1]>:]BB:GSM:TRIGger:OUTPut<[1]...4>ONTime	1 ... 2 <sup>24</sup> -1		
[SOURce<[1]>:]BB:GSM:TRIGger:OUTPut<[1]...4>PATTeRn	#B0,1...#B111...1,64		
[SOURce<[1]>:]BB:GSM:TRIGger:OUTPut<[1]...4>PERiod[:FRAMe]	1 ... 2 <sup>26</sup> -1 Frames		
[SOURce<[1]>:]BB:GSM:TRIGger:OUTPut<[1]...4>PERiod:SLOt	1 ... 2 <sup>26</sup> -1 Slots		
[SOURce<[1]>:]BB:GSM:TRIGger:OUTPut<[1]...4>PULSe:DIVider	1 ... 2 <sup>10</sup>		
[SOURce<[1]>:]BB:GSM:TRIGger:OUTPut<[1]...4>PULSe:FREQ?			Query only
[SOURce<[1]>:]BB:GSM:TRIGger:RMODe			Query only
[SOURce<[1]>:]BB:GSM:TRIGger:SLENgth	1 ...2 <sup>32</sup> -1 symbols		
[SOURce<[1]>:]BB:GSM:TRIGger:SLUNit	FRAMe   SYMBol		
[SOURce<[1]>:]BB:GSM:TRIGger:SOURce	INTernal   EXTernal   BEXTernal   OBASeband   ECLock		

**[SOURce<[1]>:]BB:GSM:CLOCK:DIVider 1 ... 65536**

The command specifies the divider for clock type **Fractional Symbols** (:BB:GSM:CLOCK:MODE FSYM) in the case of an external clock source.

With this command the only numerical suffix allowed for SOURce is 1, since the external clock source is permanently allocated to path A.

- Example:**
- "BB:GSM:CLOC:SOUR EXT"  
'selects the external clock source. The clock is supplied via the CLOCK connector.
  - "BB:GSM:CLOC:MODE FSYM"  
'selects clock type **Fractional Symbols**, i.e. the supplied clock has a rate which is a fraction of the symbol rate.
  - "BB:GSM:CLOC:DIV 2"  
'the divider for the external clock rate is 2.

*RST value	Resolution	Options	SCPI
4	1	B10/B11 and B13 K40 SOURce2 only with second option B9/B10/B11	Device-specific

[SOURce<[1]2>:]BB:GSM:CLOCK:MODE BIT | SYMBol | MSYMBol | FSYMBol

The command enters the type of externally supplied clock (:BB:GSM:CLOCK:SOURce EXT) .

When MSYMBol is used, a multiple of the symbol clock is supplied via the CLOCK connector and the symbol clock is derived internally from this. The multiplier is entered with the command :BB:GSM:CLOCK:MULTiplier.

When FSYMBol is used, a fraction of the symbol clock is supplied via the CLOCK connector and the symbol clock is derived internally from this. The divisor is entered with the command :BB:GSM:CLOCK:DIVider. This selection is only possible for external signals with a clock rate of at least 200 Hz.

With this command the only numerical suffix allowed for SOURce is 1, since the external clock source is permanently allocated to path A.

**Example:** "BB:GSM:CLOC:MODE SYMB"  
'selects clock type **Symbols**, i.e. the supplied clock is a symbol clock.

*RST value	Resolution	Options	SCPI
SYMBol	-	B10/B11 and B13 K40 SOURce2 only with second option B9/B10/B11	Device-specific

[SOURce<[1]2>:]BB:GSM:CLOCK:MULTiplier 1 ... 64

The command specifies the multiplier for clock type **Multiple Symbols** (:BB:GSM:CLOCK:MODE MSYM) in the case of an external clock source.

With this command the only numerical suffix allowed for SOURce is 1, since the external clock source is permanently allocated to path A.

**Example:** "BB:GSM:CLOC:SOUR EXT"  
'selects the external clock source. The clock is supplied via the CLOCK connector.

"BB:GSM:CLOC:MODE MSYM"  
'selects clock type **Multiple Symbols**, i.e. the supplied clock has a rate which is a multiple of the symbol rate.

"BB:GSM:CLOC:MULT 12"  
'the multiplier for the external clock rate is 12.

*RST value	Resolution	Options	SCPI
4	1	B10/B11 and B13 K40 SOURce2 only with second option B9/B10/B11	Device-specific



[SOURce<[1]>:]BB:GSM:CLOCK:SOURce INTernal | EXTernal

The command selects the clock source.

Selecting EXTernal is only possible for path A, since the external clock source is permanently allocated to path A.

**Parameter:**     **INTernal**  
                           The internal clock reference is used.

**EXTernal**  
                           The external clock reference is supplied to the CLOCK connector.

**Example:**        "BB:GSM:CLOC:SOUR EXT"  
                           'selects an external clock reference for path A. The clock is supplied via the  
                           CLOCK connector.

"BB:GSM:CLOC:MODE SYMB"  
                           'specifies that a symbol clock is supplied via the CLOCK connector.

*RST value	Resolution	Options	SCPI
INTernal	-	B10/B11 and B13 K40 SOURce2 only with second option B9/B10/B11	Device-specific

[SOURce<[1]>:]BB:GSM:EDGE:FORMat?

The command queries the modulation type in the case of EDGE. The modulation type is permanently set to 8PSK.

The command is a query command and therefore has no \*RST value.

**Example:**        "BB:GSM:EDGE:FORM?"  
                           'queries the modulation type.

Response:    "P8ED"

*RST value	Resolution	Options	SCPI
-	-	B10/B11 and B13 K40 SOURce2 only with second option B9/B10/B11	Device-specific

[SOURce<[1]>:]BB:GSM:FILTer:EDGE:TYPE LGAuss

The command sets the filter type LGAuss. This is the only possible selection in the case of digital standard GSM EDGE.

**Example:**        "BB:GSM:FILT:EDGE:TYPE LGA"  
                           'sets the filter type Gauss linearized.

*RST value	Resolution	Options	SCPI
LGAuss	-	B10/B11 and B13 K40 SOURce2 only with second option B9/B10/B11	Device-specific

**[SOURce<[1]|2>:]BB:GSM:FILTer:PARAmeter 0.15 ... 2.5**

The command sets the filter parameter. For Gaussian filter the BxT is the product of the bandwidth and the symbol duration. The default value for GSM modulation is 0.3 and for Gauss Linearized (EDGE), BT = 0.3.

**Example:**           "BB:GSM:FILT:PAR 0.4"  
                          'sets the BT value to 0.4.

*RST value	Resolution	Options	SCPI
0.3	0.01	B10/B11 and B13 K40 SOURce2 only with second option B9/B10/B11	Device-specific

**[SOURce<[1]|2>:]BB:GSM:FILTer:TYPE GAUSSs**

The command sets the filter type GAUSSs. This is the only possible selection in the case of digital standard GSM.

**Example:**           "BB:GSM:FILT:TYPE GAUS"  
                          'sets the filter type GAUSS.

*RST value	Resolution	Options	SCPI
GAUSSs	-	B10/B11 and B13 K40 SOURce2 only with second option B9/B10/B11	Device-specific

**[SOURce<[1]|2>:]BB:GSM:FORMat MSK | FSK2**

The command selects the modulation type.

**Example:**           "BB:GSM:FORM FSK2"  
                          'selects the GSM modulation type FSK.

*RST value	Resolution	Options	SCPI
MSK	-	B10/B11 and B13 K40 SOURce2 only with second option B9/B10/B11	Device-specific

**[SOURce<[1]|2>:]BB:GSM[:FRAMe<[1]|2>]:MULTIslot<0|[1]...7>:COUNT 1 ... 8**

The command defines the number of slots combined in a multislot. Since multislot involves connecting multiple slots to a single user channel, this configuration is possible only for Normal (Full Rate) bursts and EDGE bursts (SOUR:BB:GSM:FRAM:SLOT:TYPE NORM|EDGE).

The suffix in MULTIslot defines the first slot in a multislot group. In a multiframe configuration this setting applies to the slots in all frames.

```

Example:      "BB:GSM:MODE SING"
                  'selects GSM mode Frame (Single).

                  "BB:GSM:SLOT0:TYPE NORM"
                  'selects the NORMAl burst type for slot 0.

                  ... SLOT1 ... SLOT7
                  'selects burst type for slots 1 to 7 correspondingly.

                  "BB:GSM:MULT0:COUN 8"
                  'defines a multislot from all 8 slots.

                  "BB:GSM:MULT0:STAT ON"
                  'switches the multislot configuration on.
    
```

*RST value	Resolution	Options	SCPI
1	-	B10/B11 and B13 K40 SOURce2 only with second option B9/B10/B11	Device-specific

**[SOURce<[1]|2>:]BB:GSM[:FRAMe<[1]|2>]:MULTIslot<0|[1]...7>:STATE ON | OFF**

The command switches the multislot configuration on.

The suffix in MULTIslot defines the first slot in a multislot group. In a multiframe configuration this setting applies to the slots in all frames.

```

Example:      "BB:GSM:MODE DOUB"
                  'selects GSM mode Frame (Double).

                  "BB:GSM:SLOT0:TYPE NORM"
                  'selects the NORMAl burst type for slot 0.

                  ... SLOT1 ... SLOT7
                  'selects burst type for slots 1 to 7 correspondingly.

                  "BB:GSM:MULT0:COUN 8"
                  'defines a multislot from all 8 slots.

                  "BB:GSM:MULT0:STAT ON"
                  'switches the multislot configuration on.
    
```

*RST value	Resolution	Options	SCPI
OFF	-	B10/B11 and B13 K40 SOURce2 only with second option B9/B10/B11	Device-specific

**[SOURce<[1]>:]BB:GSM[:FRAMe<[1]>]:PREDefined:CATalog?**

This command reads out the files with predefined frame settings. The directory is preset, therefore a path cannot be specified.

The command is a query command and therefore has no \*RST value.

**Example:** "BB:GSM:FRAM:PRED:CAT?"  
'reads out all the files with predefined frame settings.

Response:

"Edge0, EdgeAll, GsmEdge, NormalBurst0, NormalBurstAll"  
'the file names of the files with the predefined frame settings are returned.

*RST value	Resolution	Options	SCPI
	-	B10/B11 and B13 K40 SOURce2 only with second option B9/B10/B11	Device-specific

**[SOURce<[1]>:]BB:GSM[:FRAMe<[1]>]:PREDefined:LOAD <file\_name>**

This command loads the selected file with predefined frame settings. The directory is pre-set, therefore a path cannot be specified.

This command triggers an event and therefore has no \*RST value and no query form.

**Example:** "BB:GSM:FRAM:PRED:LOAD 'Edge0'"  
'loads file 'Edge0' with the predefined frame setting 'Edge Burst in Slot 0'.

*RST value	Resolution	Options	SCPI
	-	B10/B11 and B13 K40 SOURce2 only with second option B9/B10/B11	Device-specific

**[SOURce<[1]>:]BB:GSM:FRAMe<[1]>:REPetitions 1 ... 500**

The command defines the number of repetitions for the selected frame in GSM mode Frame (Double).

**Example:** "BB:GSM:MODE DOUB"  
'selects GSM mode Frame (Double).

"BB:GSM:FRAM2:REP 10"  
'sets 10 repetitions for frame 2.

*RST value	Resolution	Options	SCPI
1 / 1	-	B10/B11 and B13 K40 SOURce2 only with second option B9/B10/B11	Device-specific

**[SOURce<[1]|2>:]BB:GSM[:FRAMe<[1]|2>]:SLOT<0|[1]...7>:TYPE**  
 NORMal | HALF | EDGE | SYNC | FCORrection | DUMMy | ACCess | ADATa | AEDGe

The command selects the burst (slot) type. The types All Data GSM (ADATa) and All Data EDGE (AEDGe) are not defined in the standard.

**Example:** "BB:GSM:SLOT:TYPE DUMM"  
 'selects DUMMY burst type for slot 1.

*RST value	Resolution	Options	SCPI
NORMal	-	B10/B11 and B13 K40 SOURce2 only with second option B9/B10/B11	Device-specific

**[SOURce<[1]|2>:]BB:GSM[:FRAMe<[1]|2>]:SLOT<0|[1]...7>[:USER<[1]|2>]:ATTenuation A1...A7**

The command selects one of seven possible values for the level attenuation. This value defines by how much the power of the selected slot with power control level :BB:GSM:SLOT:LEV ATT will be reduced in relation to the normal output power (attribute ...:LEVEL FULL). The seven possible values are set using the command :SOURce:BB:GSM:SATTenuation<n>.

**Example:** "BB:GSM:MODE SING"  
 'selects GSM mode Frame (Single).  
 "BB:GSM:SLOT1:LEV ATT"  
 'sets level attenuation mode for slot 1.  
 "BB:GSM:SATT1 12dB"  
 'sets the level attenuation for selection A1 to 12 dB.  
 "BB:GSM:SLOT1:ATT A1"  
 'sets the level attenuation for slot 0 to 12 dB.

*RST value	Resolution	Options	SCPI
0 dB	0.01 dB	B10/B11 and B13 K40 SOURce2 only with second option B9/B10/B11	Device-specific

**[SOURce<[1]|2>:]BB:GSM[:FRAMe<[1]|2>]:SLOT<0|[1]...7>[:USER<[1]|2>]:DUMMy:MIXed:PATTern?**

This command outputs the bit pattern of the Mixed field of the Dummy burst. The contents of the Mixed field is fixed and specified by the standard, the length is 142 bits.

The command is a query command and therefore has no \*RST value.

**Example:** "BB:GSM:SLOT1:TYPE DUMM"  
 'selects Dummy burst for slot 1.  
 "BB:GSM:SLOT1:DUMM:MIX:PATT?"  
 'outputs the bit pattern of the Mixed field.

*RST value	Resolution	Options	SCPI
-	-	B10/B11 and B13 K40 SOURce2 only with second option B9/B10/B11	Device-specific

**[SOURce<[1]|2>:]BB:GSM[:FRAMe<[1]|2>]:SLOT<0|[1]...7>[:USER<[1]|2>]:ETSC**  
 STANdard | CTS | COMPact | USER

The command selects an extended training sequence for the Synchronization burst. There is a choice of three predefined sequences STANdard | CTS | COMPact and, if defined, a USER sequence (only for selection of burst type :BB:GSM:SLOT:TYPE SYNC).

**Example:** "BB:GSM:SLOT:TYPE SYNC"  
 'selects Synchronization burst for slot 1.

"BB:GSM:SLOT:ETSC CTS"  
 'selects the extended training sequence CTS.

*RST value	Resolution	Options	SCPI
STANdard	-	B10/B11 and B13 K40 SOURce2 only with second option B9/B10/B11	Device-specific

**[SOURce<[1]|2>:]BB:GSM[:FRAMe<[1]|2>]:SLOT<0|[1]...7>[:USER<[1]|2>]:FCORrection:FIXed**  
 STANdard | COMPact | USER

The command selects the content of the FIXED field for the Frequency Correction burst. There is a choice of two predefined sequences STANdard and COMPact and, if defined, a USER sequence (only for burst type selection :BB:GSM:SLOT:TYPE FCORrection).

**Example:** "BB:GSM:SLOT:TYPE FCOR"  
 'selects Frequency Correction burst for slot 1.

"BB:GSM:SLOT:FCOR:FIX COMP"  
 'selects content type COMPact for the Fixed field.

*RST value	Resolution	Options	SCPI
STANdard	-	B10/B11 and B13 K40 SOURce2 only with second option B9/B10/B11	Device-specific

[SOURce<[1]|2>]:BB:GSM[:FRAMe<[1]|2>]:SLOT<0|[1]...7>[:USER<[1]|2>]:FCORrection:FIXed:PATTern  
#B000...0,142 .... #B111...1,142

The command enters the bit pattern of the FIXED field for the Frequency Correction burst. The length is 142 bits. Superfluous bits are truncated on input. Missing bits are filled with 0. The command is valid only for the selection :BB:GSM:SLOT:FCOR:FIX USER and for burst type selection :BB:GSM:SLOT:TYPE FCOR.

**Example:** "BB:GSM:SLOT:TYPE FCOR"  
'selects Synchronization burst for slot 1.

"BB:GSM:SLOT:FCOR:FIX USER"  
'selects content type USER for the Fixed field.

"BB:GSM:SLOT:FCOR:FIX:PATT #B0,142"  
'enters the content of the field.

*RST value	Resolution	Options	SCPI
Bit pattern from the STANdard	-	B10/B11 and B13 K40 SOURce2 only with second option B9/B10/B11	Device-specific

[SOURce<[1]|2>]:BB:GSM[:FRAMe<[1]|2>]:SLOT<0|[1]...7>[:USER<[1]|2>]:LEVeL OFF|ATT|FULL

The command defines the power control level of the selected slot.

**Parameter:** **OFF**  
The slot is inactive.

**ATT**  
The power is reduced by the amount defined using :BB:GSM:SLOT:ATT.

**FULL**  
Full power as specified by the level setting.

**Example:** "BB:GSM:SLOT2:LEV FULL"  
'selects power control level Full Power for slot 2.

*RST value	Resolution	Options	SCPI
Slot 0: FULL Slots 1...7: OFF	-	B10/B11 and B13 K40 SOURce2 only with second option B9/B10/B11	Device-specific

**[SOURce<[1]|2>:]BB:GSM[:FRAMe<[1]|2>]:SLOT<0|[1]...7>[:USER<[1]|2>]:PREDeFined:CATalog?**

This command reads out the files with predefined slot settings. The directory is pre-set, therefore a path cannot be specified.

The command is a query command and therefore has no \*RST value. The numeric suffixes in all key words are irrelevant for this command.

**Example:** "BB:GSM:SLOT:PRED:CAT?"  
 'reads out all the files with predefined frame settings.

Response: "GSM\_NB\_PN9\_TSC0,EDGE\_NB\_PN9\_TSC0"  
 'the files 'GSM\_NB\_PN9\_TSC0' and 'EDGE\_NB\_PN9\_TSC0' are available.

*RST value	Resolution	Options	SCPI
	-	B10/B11 and B13 K40 SOURce2 only with second option B9/B10/B11	Device-specific

**[SOURce<[1]|2>:]BB:GSM[:FRAMe<[1]|2>]:SLOT<0|[1]...7>[:USER<[1]|2>]:PREDeFined:LOAD <file\_name>**

This command loads the selected file with predefined slot settings. The directory is pre-set, therefore a path cannot be specified.

This command triggers an event and therefore has no \*RST value and no query form.

**Example:** "BB:GSM:SLOT:PRED:LOAD 'GSM\_NB\_PN9\_TSC0' "  
 'loads the settings of file 'GSM\_NB\_PN9\_TSC0' for slot 1 in frame 1.

*RST value	Resolution	Options	SCPI
	-	B10/B11 and B13 K40 SOURce2 only with second option B9/B10/B11	Device-specific

**[SOURce<[1]|2>:]BB:GSM[:FRAMe<[1]|2>]:SLOT<0|[1]...7>[:USER<[1]|2>]:SFLag 0 | 1**

The command sets the Stealing Flag state (only for Normal burst :BB:GSM:SLOT:TYPE NORM).

**Example:** "BB:GSM:SLOT2:TYPE NORM"  
 'selects NORMAL burst type for slot 2.  
 "BB:GSM:SLOT2:SF 1"  
 'sets the Stealing Flag for slot 2 to value 1.

*RST value	Resolution	Options	SCPI
0	-	B10/B11 and B13 K40 SOURce2 only with second option B9/B10/B11	Device-specific



[SOURce<[1]|2>:]BB:GSM[:FRAMe<[1]|2>]:SLOT<0|[1]...7>[:USER<[1]|2>]:SFLag:USE ON | OFF

The command enables or disables the use of Stealing Flags. If not used, the Stealing Flags bits are allocated to the DATA fields (only for Normal burst :BB:GSM:SLOT:TYPE NORM).

**Example:** "BB:GSM:SLOT2:TYPE NORM"  
'selects NORMAL burst type for slot 2.

"BB:GSM:SLOT2:SFL 1"  
'sets Stealing Flags for slot 2 to the value 1.

"BB:GSM:SLOT2:SFL:USE ON"  
'enables the use of Stealing Flags for slot 2.

*RST value	Resolution	Options	SCPI
ON	-	B10/B11 and B13 K40 SOURce2 only with second option B9/B10/B11	Device-specific

[SOURce<[1]|2>:]BB:GSM[:FRAMe<[1]|2>]:SLOT<0|[1]...7>[:USER<[1]|2>][:SOURce]:DATA  
PN9| PN11| PN15| PN16| PN16| PN20| PN21| PN23| USB| DLISt| ALL0| ALL1| PATTErn

The command defines the data source for the DATA fields in the burst. This command is valid only when burst types that contain data fields are selected. If a burst contains multiple DATA fields, these are treated as a continuous field, and for instance data such as a pseudo-random sequence is continued without interruption from one DATA field to the next.

In **GSM Mode Unframed**, this command defines the data source for the unframed signal. The suffix in :SLOT has to be set to 0 (BB:GSM:SLOT0:DATA).

**Parameter:** **PNxx**  
The pseudo-random sequence generator is used as the data source. There is a choice of different lengths of random sequence.

**DLISt**  
A data list is used. The data list is selected with the aid of command  
SOURce:BB:GSM:SLOT:DATA:DLISt.

**ALL0 | ALL1**  
Internal 0 or 1 data is used.

**PATTErn**  
Internal data is used. The bit pattern for the data is defined with the aid of command :SOURce:BB:GSM:SLOT:DATA:PATTErn.

**Example:** "BB:GSM:SLOT2:TYPE NORM"  
'selects NORMAL burst type for slot 2.

"BB:GSM:SLOT2:DATA PN15"  
'selects internal PRBS data with period length  $2^{15}-1$  as the data source for the DATA fields in the burst. The pseudo-random sequence is continued without interruption from one DATA field to the next.

*RST value	Resolution	Options	SCPI
PN9	-	B10/B11 and B13 K40 SOURce2 only with second option B9/B10/B11	Device-specific

[SOURce<[1]|2>:]BB:GSM[:FRAMe<[1]|2>]:SLOT<0|[1]...7>[:USER<[1]|2>][:SOURce]:DATA:DLIS <data list name>

The command selects a data list. This command is only valid for bursts with DATA fields. This data list is only used if it is set as the data source with the aid of command :BB:GSM:SLOT:DATA:DLIS.

This command triggers an event and therefore has no \*RST value.

**Example:** "BB:GSM:SLOT2:TYPE NORM"  
 'selects NORMAL burst type for slot 2.  
 "BB:GSM:SLOT2:DATA DLIS"  
 'selects internal data lists as the data source for DATA fields.  
 "BB:GSM:SLOT2:DATA:DLIS 'test'"  
 'selects the 'test' data list. The data list is continued without interruption from one DATA field to the next.

*RST value	Resolution	Options	SCPI
-	-	B10/B11 and B13 K40 SOURce2 only with second option B9/B10/B11	Device-specific

[SOURce<[1]|2>:]BB:GSM[:FRAMe<[1]|2>]:SLOT<0|[1]...7>[:USER<[1]|2>][:SOURce]:DATA:DLIS:CATalog?

This command reads out the data list files in the default directory. The default directory is set using command MMEM:CDIRectory. A path can also be specified, in which case the files in the specified directory are read. Only files with the file extension \*.dm\_iqd will be listed.

The command is a query and therefore has no \*RST value.

**Example:** "MMEM:CDIR 'D:\user\dlist\_gsm"  
 'sets the default directory to D:\user\dlist\_gsm.  
 "BB:GSM:SLOT2:DATA:DLIS:CAT?"  
 'queries the available data lists in D:\user\dlist\_gsm.  
 Response: "'test\_01', "test\_02"  
 'data lists "test\_01' and 'test\_02' are available in D:\user\dlist\_gsm.

*RST value	Resolution	Options	SCPI
-	-	B10/B11 and B13 K40 SOURce2 only with second option B9/B10/B11	Device-specific

[SOURce<[1]|2>:]BB:GSM[:FRAMe<[1]|2>]:SLOT<0|[1]...7>[:USER<[1]|2>][:SOURce]:DATA:PATTern  
#B0,1 .... #B111...1,64

The command selects the data pattern for the internal data when PATTern is selected as the data source. The length depends on the length of the data fields in the selected burst type.

**Example:** "BB:GSM:SLOT2:TYPE ACC"  
'selects the Access burst type for slot 2. This burst type contains a 36-bit data field.

"BB:GSM:SLOT2:DATA PATT"  
'selects Pattern as the data source.

"BB:GSM:SLOT2:DATA:PATT #H801FA,20"  
'generates the data for the data field in the burst.

*RST value	Resolution	Options	SCPI
0	-	B10/B11 and B13 K40 SOURce2 only with second option B9/B10/B11	Device-specific

[SOURce<[1]|2>:]BB:GSM[:FRAMe<[1]|2>]:SLOT<0|[1]...7>[:USER<[1]|2>][:SOURce]:TSC:USER  
#B0...#B111 ,1...26/78 bits

The command specifies the user-defined training sequence code. This code is used if the USER parameter is set with the aid of the :BB:GSM:SLOT:TSC:SEL command described above. The length is 26 bits for :BB:GSM:SLOT:TYPE NORMAl and 78 bits for :BB:GSM:SLOT:TYPE EDGE.

**Example:** "BB:GSM:SLOT3:TSC:USER #H3FFFFFFF"  
'enters the user-defined training sequence for slot 3.

*RST value	Resolution	Options	SCPI
#H0970897	-	B10/B11 and B13 K40 SOURce2 only with second option B9/B10/B11	Device-specific

[SOURce<[1]|2>:]BB:GSM[:FRAMe<[1]|2>]:SLOT<0|[1]...7>[:USER<[1]|2>]:SYNC:SELEct  
T0 | T1 | USER

The command selects a training sequence (SYNC sequence) for the Access burst (only for burst type selection :BB:GSM:SLOT:TYPE ACC).

**Example:** "BB:GSM:SLOT1:TYPE ACC"  
'selects Access burst for slot 1.

"BB:GSM:SLOT1:SYNC:SEL T1"  
'selects Sync sequence T1.

*RST value	Resolution	Options	SCPI
T0	-	B10/B11 and B13 K40 SOURce2 only with second option B9/B10/B11	Device-specific

[SOURce<[1]|2>:]BB:GSM[:FRAMe<[1]|2>]:SLOT<0|[1]...7>[:USER<[1]|2>]:SYNC:USER  
#B0,1...#B111...,41

The command outputs the bit pattern of the User Sync sequence for the Access burst. The length is 64 bits. Superfluous bits are truncated on input. Missing bits are filled with 0. The command is valid only for selection :BB:GSM:SLOT:SYNC:SEL USER and for burst type selection :BB:GSM:SLOT:TYPE ACC.

**Example:** "BB:GSM:SLOT1:TYPE ACC"  
'selects Access burst for slot 1.

"BB:GSM:SLOT1:SYNC:SEL USER"  
'selects the User Sync sequence.

"BB:GSM:SLOT1:SYNC:USER #HFFFFFFF0,41"  
'enters the User Sync sequence.

*RST value	Resolution	Options	SCPI
Bit pattern from T0	-	B10/B11 and B13 K40 SOURce2 only with second option B9/B10/B11	Device-specific

[SOURce<[1]|2>:]BB:GSM[:FRAMe<[1]|2>]:SLOT<0|[1]...7>[:USER<[1]|2>]:TSC:SElect  
T0 ... T7 | USER

The command selects the training sequence code. The values specified in GSM 5.02 are T0...T7. When USER is selected, the value specified with the aid of the . . . :TSC:USER command described next is used.

**Example:** "BB:GSM:MODE SING"  
'selects Single Frame mode.

"BB:GSM:SLOT2:TYPE NORM"  
'selects Normal burst for slot 2.

"BB:GSM:SLOT2:TSC:SEL T3"  
'selects training sequence code T3 for slot 2.

*RST value	Resolution	Options	SCPI
T0	-	B10/B11 and B13 K40 SOURce2 only with second option B9/B10/B11	Device-specific

**[SOURce<[1]>:]BB:GSM[:FRAMe<[1]>]:SLOT<0[1]...7>[:USER<[1]>]:ULIS:CATalog?**

This command reads out the files with user defined slot settings in the default directory. The default directory is set using command `MMEM:CDIRectory`. A path can also be specified, in which case the files in the specified directory are read. Only files with the file extension `*.gsm_slu` will be listed.

The command is a query command and therefore has no \*RST value.

**Example:** `"MMEM:CDIR 'D:\user\slots"`  
 'sets the default directory to D:\user\slots.  
`"BB:GSM:SLOT:ULIS:CAT?"`  
 'reads out all the files with user defined slot settings in the default directory.  
 Response: `"'test_01'"`  
 'the file 'test\_01' with a user defined slot setting is available.

*RST value	Resolution	Options	SCPI
	-	B10/B11 and B13 K40 SOURce2 only with second option B9/B10/B11	Device-specific

**[SOURce<[1]>:]BB:GSM[:FRAMe<[1]>]:SLOT<0[1]...7>[:USER<[1]>]:ULIS:DELeTe <file\_name>**

This command deletes the selected file with user defined slot settings. The directory is set using command `MMEM:CDIRectory`. A path can also be specified, in which case the files in the specified directory are read. The file extension may be omitted. Only files with the file extension `*.gsm_slu` will be deleted.

This command triggers an event and therefore has no \*RST value and no query form.

**Example:** `"BB:GSM:SLOT:ULIS:DEL 'NB'"`  
 'deletes file 'NB'.

*RST value	Resolution	Options	SCPI
	-	B10/B11 and B13 K40 SOURce2 only with second option B9/B10/B11	Device-specific

**[SOURce<[1]|2>:]BB:GSM[:FRAMe<[1]|2>]:SLOT<0|[1]...7>[:USER<[1]|2>]:ULIS:LOAD**  
 <file\_name>

This command loads the selected file with user defined slot settings. The directory is set using command `MMEM:CDIRectory`. A path can also be specified, in which case the files in the specified directory are read. The file extension may be omitted. Only files with the file extension `*.gsm_slu` will be loaded.

This command triggers an event and therefore has no \*RST value and no query form.

**Example:**           "BB:GSM:SLOT:ULIS:LOAD 'NB'"  
                       'loads file 'NB'.

*RST value	Resolution	Options	SCPI
	-	B10/B11 and B13 K40 SOURce2 only with second option B9/B10/B11	Device-specific

**[SOURce<[1]|2>:]BB:GSM[:FRAMe<[1]|2>]:SLOT<0|[1]...7>[:USER<[1]|2>]:ULIS:STORE**  
 <file\_name>

This command stores the current slot settings into the selected file. The directory is set using command `MMEM:CDIRectory`. A path can also be specified, in which case the files in the specified directory are read. Only the file name has to be entered. User slots are stored as files with the specific file extensions `*.gsm_slu`.

This command triggers an event and therefore has no \*RST value and no query form.

**Example:**           "BB:GSM:SLOT:ULIS:STOR 'EDGE'"  
                       'stores the current slot settings into file 'EDGE'.

*RST value	Resolution	Options	SCPI
	-	B10/B11 and B13 K40 SOURce2 only with second option B9/B10/B11	Device-specific

**[SOURce<[1]]2>:]BB:GSM:FRAMe:ULIS:CATalog?**

This command reads out the files with user defined frame settings in the default directory. The default directory is set using command `M MEM:CDIRectory`. A path can also be specified, in which case the files in the specified directory are read. Only files with the file extension `*.gsm_fu` will be listed.

The command is a query command and therefore has no `*RST` value.

**Example:** `"M MEM:CDIR 'D:\user\frames"`  
 'sets the default directory to D:\user\frames.  
`"BB:GSM:FRAM:ULIS:CAT?"`  
 'reads out all the files with user defined frame settings in the default directory.  
**Response:** `"NB_all"`  
 'the file 'NB\_all' with a user defined frame setting is available.

*RST value	Resolution	Options	SCPI
	-	B10/B11 and B13 K40 SOURce2 only with second option B9/B10/B11	Device-specific

**[SOURce<[1]]2>:]BB:GSM:FRAMe:ULIS:DELete <file\_name>**

This command deletes the selected file with user defined frame settings. The directory is set using command `M MEM:CDIRectory`. A path can also be specified, in which case the files in the specified directory are read. The file extension may be omitted. Only files with the file extension `*.gsm_fu` will be deleted.

This command triggers an event and therefore has no `*RST` value and no query form.

**Example:** `"BB:GSM:FRAM:ULIS:DEL 'NB_all'"`  
 'deletes file 'NB\_all'.

*RST value	Resolution	Options	SCPI
	-	B10/B11 and B13 K40 SOURce2 only with second option B9/B10/B11	Device-specific

**[SOURce<[1]]2>:]BB:GSM:FRAMe:ULIS:LOAD <file\_name>**

This command loads the selected file with user defined frame settings. The directory is set using command `M MEM:CDIRectory`. A path can also be specified, in which case the files in the specified directory are read. The file extension may be omitted. Only files with the file extension `*.gsm_fu` will be loaded.

This command triggers an event and therefore has no `*RST` value and no query form.

**Example:** `"BB:GSM:FRAM:ULIS:LOAD 'NB_all'"`  
 'loads file 'NB\_all'.

*RST value	Resolution	Options	SCPI
	-	B10/B11 and B13 K40 SOURce2 only with second option B9/B10/B11	Device-specific

**[SOURce<[1]>:]BB:GSM:FRAMe:ULIS:STORe <file\_name>**

This command stores the current frame settings into the selected file. The directory is set using command `MMEM:CDIRectory`. A path can also be specified, in which case the files in the specified directory are read. Only the file name has to be entered. User Standards are stored as files with the specific file extensions `*.gsm_fu`.

This command triggers an event and therefore has no `*RST` value and no query form.

**Example:** `"BB:GSM:FRAM:ULIS:STOR 'EDGE_all'"`  
 'stores the current frame settings into file 'EDGE\_all'.

*RST value	Resolution	Options	SCPI
	-	B10/B11 and B13 K40 SOURce2 only with second option B9/B10/B11	Device-specific

**[SOURce<[1]>:]BB:GSM:FSK:DEVIation <numeric\_value>**

The command sets the modulation deviation when `:BB:GSM:FORMat FSK2` is selected. The range of values depends on the symbol rate (`:BB:GSM:SRATe`):  $0.1 \times f_{\text{Symb}} \dots 1.5 \times f_{\text{Symb}}$  (max. 10 MHz)

The maximum deviation is 10 MHz.

**Example:** `"BB:GSM:FORM FSK2"`  
 'selects the GSM modulation type GFSK.  
`"BB:GSM:FSK:DEV 37.6 kHz"`  
 'sets the FSK deviation to 37.6 kHz.

*RST value	Resolution	Options	SCPI
67.708 kHz	-	B10/B11 and B13 K40 SOURce2 only with second option B9/B10/B11	Device-specific

**[SOURce<[1]>:]BB:GSM:ISLength ON | OFF**

The command selects whether the 1/4 symbol of a GSM slot (length = 156.25 symbols) will be ignored (ON) or compensated for by an extra symbol every 4th slot (OFF). When ON is selected, all slots are 156 symbols long. When OFF is selected, some slots are 157 symbols long..

**Example:** `"BB:GSM:ISL ON"`  
 'selects a constant length of 156 symbols for all slots.

*RST value	Resolution	Options	SCPI
OFF	-	B10/B11 and B13 K40 SOURce2 only with second option B9/B10/B11	Device-specific



[SOURce<[1]2>:]BB:GSM:MODE UNFRamed | SINGle | DOUBle

The command selects GSM mode.

**Parameter:**       **UNFRamed**  
                           Modulation signal without slot and frame structure.

**SINGle**  
                           Modulation signal consisting of one frame.

**DOUBle**  
                           Modulation signal in which two frames are defined and then combined by some method into a single multiframe signal.

**MULTiframe**  
                           Multiframe signal.

**Example:**           "BB:GSM:MODE SING"  
                           'sets the **Single Frame** GSM mode. Only the commands for defining a single frame are valid.

*RST value	Resolution	Options	SCPI
SINGle	-	B10/B11 and B13 K40 SOURce2 only with second option B9/B10/B11	Device-specific

[SOURce<[1]2>:]BB:GSM:PRAMP:BBONly[:STATe] ON | OFF

This command selects power ramping in the baseband only or mixed power ramping in the baseband and the RF section. The **ON** setting is mandatory if, with power ramping active, only the baseband signal is output (I/Q outputs), or if a baseband signal is applied to two RF paths (RF A and RF B).

Only then can a signal with a defined, predictable level be output.

**Example:**           "BB:GSM:PRAMP:BBON ON"  
                           'selects power ramping in the baseband only.

*RST value	Resolution	Options	SCPI
OFF		B10/B11 and B13 K40 SOURce2 only with second option B9/B10/B11	Device-specific

[SOURce<[1]2>:]BB:GSM:PRAMP:FDELay - 9 ... +9 Symbols

The command sets the offset in the Falling edge of the ramp envelope at the end of a slot. A positive value gives rise to a ramp delay and a negative value advances the ramp. The setting is expressed in symbols.

**Example:**           "BB:GSM:PRAMP:FDEL -1"  
                           'sets an advance of 1 symbol in the falling edge of the envelope at the end of the slot.

*RST value	Resolution	Options	SCPI
0 symbols	1 symbol	B10/B11 and B13 K40 SOURce2 only with second option B9/B10/B11	Device-specific

[SOURce<[1]|2>:]BB:GSM:PRAMp:RDElay -9 ... +9 Symbols

The command sets the offset in the Rising edge of the ramp envelope at the start of a slot. A positive value gives rise to a ramp delay and a negative value advances the ramp. The setting is expressed in symbols.

**Example:** "BB:GSM:PRAM:RDEL -1"  
 'sets an advance of 1 symbol in the rising edge of the envelope at the start of the slot.

*RST value	Resolution	Options	SCPI
0 symbols	1 symbol	B10/B11 and B13 K40 SOURce2 only with second option B9/B10/B11	Device-specific

[SOURce<[1]|2>:]BB:GSM:PRAMp:SHApe LINear | COSine

The command sets the edge shape of the ramp envelope.

**Parameter:** **LINear**  
 The transmitted power rises and falls linear fashion.

**COSine**  
 The transmitted power rises and falls in the shape of a cosine.

**Example:** "BB:GSM:PRAM:SHAP LIN"  
 'sets a cosine-shaped rise and fall to the edge.

*RST value	Resolution	Options	SCPI
COS	-	B10/B11 and B13 K40 SOURce2 only with second option B9/B10/B11	Device-specific

[SOURce<[1]|2>:]BB:GSM:PRAMp:TIME 0.3 ... 16.0 Symbols

The command sets the edge slope of the ramp envelope. This specifies the number of symbols over which the switching operation should be stretched when the transmitted power is turned on and off.

**Example:** "BB:GSM:PRAM:TIME 6"  
 'sets the duration of the switching operation to 6 symbols.

*RST value	Resolution	Options	SCPI
5.0 symbols	0.1	B10/B11 and B13 K40 SOURce2 only with second option B9/B10/B11	Device-specific

**[SOURce<[1]]2>:]BB:GSM:PRESet**

The command sets all modulation parameters, including slot settings, to their GSM default values. The ON status (SOURce:BB:GSM:STATe ON | OFF) is not affected by this command.

This command triggers an event and therefore has no \*RST value and no query form.

**Example:** "BB:GSM:PRESet"  
'resets all GSM settings to default values.

*RST value	Resolution	Options	Dependency	SCPI
-	-	B10/B11 and B13 K40 SOURce2 only with second option B9/B10/B11	:BB:GSM:CLOC:DEL 0 :BB:GSM:CLOC:MODE SYMB :BB:GSM:CLOC:SOUR INT :BB:GSM:FILT:EDGE:TYPE GAUSSs :BB:GSM:FILT:TYPE GAUSSs :BB:GSM:FILT:PAR 0.3 :BB:GSM:FORM MSK :BB:GSM:FSK:DEV 67.708kHz :BB:GSM:ISL OFF :BB:GSM:MODE SING :BB:GSM:MULT:STAT OFF :BB:GSM:PRAM:DEL 0 :BB:GSM:PRAM:ROFF 0 :BB:GSM:PRAM:FOFF 0 :BB:GSM:PRAM:SHAP COS :BB:GSM:PRAM:TIME 5 :BB:GSM:SEQ AUTO :BB:GSM:SLOT0:LEV FULL :BB:GSM:SLOT<1...7>:LEV OFF :BB:GSM:SLOT<1...7>:TYPE NORM :BB:GSM:SLOT<1...7>:SFL 0 :BB:GSM:SLOT<1...7>:DATA PN9 :BB:GSM:SLOT<1...7>:TSC 0 :BB:GSM:SMOD GSM :BB:GSM:SRAT 270.833 kHz :BB:GSM:TRIG:DEL 0 :BB:GSM:TRIG:INH 0 :BB:GSM:TRIG:OUTP:DEL 0 :BB:GSM:TRIG:OUTP:MODE FRAM :BB:GSM:TRIG:OUTP:PER 1 :BB:GSM:TRIG:SOUR INT	Device-specific

**[SOURce<[1]]2>:]BB:GSM:SATTenuation A1...A7**

The command sets up to seven different values for level attenuation. The various values are defined by the suffix to SATTenuation. These values are used when defining the level attenuation of individual slots with the aid of the command SOUR:BB:GSM:FRAM:SLOT:USER:ATTenuation.

**Example:** "BB:GSM:MODE SING"  
'selects GSM mode Frame (Single).  
"BB:GSM:SLOT1:LEV ATT"  
'sets level attenuation mode for slot 1.  
"BB:GSM:SATT1 12dB"  
'sets the level attenuation for selection A1 to 12 dB.  
"BB:GSM:SLOT1:ATT A1"  
'sets the level attenuation for slot 1 to 12 dB.

*RST value	Resolution	Options	SCPI
0 dB	0.01 dB	B10/B11 and B13 K40 SOURce2 only with second option B9/B10/B11	Device-specific

**[SOURce<[1]>:]BB:GSM:SETting:CATalog?**

This command reads out the files with GSM settings in the default directory. The default directory is set using command `MMEM:CDIRectory`. A path can also be specified, in which case the files in the specified directory are read. Only files with the file extension `*.gsm` will be listed.

The command is a query command and therefore has no `*RST` value.

**Example:** `"MMEM:CDIR 'D:\user\dig_mod"`  
`'sets the default directory to D:\user\dig_mod.`  
`"BB:GSM:SETT:CAT?"`  
`'reads out all the files with GSM settings in the default directory.`  
 Response: `"'gsm_1'`

*RST value	Resolution	Options	SCPI
	-	B10/B11 and B13 K40 SOURce2 only with second option B9/B10/B11	Device-specific

**[SOURce<[1]>:]BB:GSM:SETting:DELeTe <file\_name>**

This command deletes the selected file with GSM settings. The directory is set using command `MMEM:CDIRectory`. A path can also be specified, in which case the files in the specified directory are read. The file extension may be omitted. Only files with the file extension `*.gsm` will be deleted.

This command triggers an event and therefore has no `*RST` value and no query form.

**Example:** `"BB:GSM:SETT:DEL 'gsm_1'"`  
`'deletes file 'gsm_1'.`

*RST value	Resolution	Options	SCPI
	-	B10/B11 and B13 K40 SOURce2 only with second option B9/B10/B11	Device-specific

**[SOURce<[1]>:]BB:GSM:SETting:LOAD <file\_name>**

This command loads the selected file with GSM settings. The directory is set using command `MMEM:CDIRectory`. A path can also be specified, in which case the files in the specified directory are read. The file extension may be omitted. Only files with the file extension `*.gsm` will be loaded.

This command triggers an event and therefore has no `*RST` value and no query form.

**Example:** `"BB:GSM:SETT:LOAD 'gsm_1'"`  
`'loads file 'gsm_1'.`

*RST value	Resolution	Options	SCPI
	-	B10/B11 and B13 K42 SOURce2 only with second option B9/B10/B11	Device-specific

**[SOURce<[1]>:]BB:GSM:SETTing:STORe <file\_name>**

This command stores the current GSM settings into the selected file. The directory is set using command `MMEM:CDIRectory`. A path can also be specified, in which case the files in the specified directory are read. Only the file name has to be entered. GSM settings are stored as files with the specific file extensions `*.gsm`.

This command triggers an event and therefore has no `*RST` value and no query form.

**Example:** `"BB:GSM:SETT:STOR 'gsm_1'"`  
'stores the current GSM settings into file 'gsm\_1'.

*RST value	Resolution	Options	SCPI
	-	B10/B11 and B13 K42 SOURce2 only with second option B9/B10/B11	Device-specific

**[SOURce<[1]>:]BB:GSM:SEQUence AUTO | RETRigger | AAUTo | ARETrigger | SINGle**

The command selects the trigger mode.

**Parameter:** **AUTO**  
The frames are generated continuously.

**RETRigger**  
The frames are generated continuously. A trigger event (internal or external) causes a restart.

**AAUTo**  
The frames are generated only when a trigger event occurs. After the trigger event the signal is generated continuously. Signal generation is stopped with command `SOUR:BB:GSM:TRIG:ARM:EXEC` and started again when a trigger event occurs.

**ARETrigger**  
The frames are generated only when a trigger event occurs. The device automatically toggles to RETRIG mode. Every subsequent trigger event causes a restart. Signal generation is stopped with command `SOUR:BB:GSM:TRIG:ARM:EXEC` and started again when a trigger event occurs.

**SINGle**  
The signal is generated only when a trigger event occurs. After the trigger event the signal is generated once to the set sequence length (`SOUR:BB:GSM:TRIG:SLEN`). Every subsequent trigger event causes a restart.

**Example:** `"BB:GSM:SEQ AAUT"`  
'sets the **Armed\_auto** trigger mode; the device waits for the first trigger (e.g. with `*TRG`) and then generates the frames continuously.

*RST value	Resolution	Options	SCPI
AUTO	-	B10/B11 and B13 K40 SOURce2 only with second option B9/B10/B11	Device-specific

[SOURce<[1]>:]BB:GSM:SMODe GSM | EDGE

The command selects the modulation signal for the mode Unframed (:BB:GSM:MODE UNFR). The modulation type and filter type are set in accordance with the selection.

**Example:** "BB:GSM:SMOD GSM"  
'selects a GSM modulation signal for the Unframed mode.

RST value	Resolution	Options	SCPI
GSM	-	B10/B11 and B13 K40 SOURce2 only with second option B9/B10/B11	Device-specific

[SOURce<[1]>:]BB:GSM:SRATe 400 Hz ... 25 MHz

The command sets the symbol clock. Possible units are Hz, kHz, MHz, Sym/s, kSym/s, MSym/s..

**Example:** "BB:GSM:SRAT 270.9 kHz"  
'sets the symbol clock to 270.9 kHz.

RST value	Resolution	Options	SCPI
270.833 kHz	0.001	B10/B11 and B13 K40 SOURce2 only with second option B9/B10/B11	Device-specific

[SOURce<[1]>:]BB:GSM:STATe ON | OFF

The command switches on the modulation in accordance with the GSM standard. Any other standards or digital modulation that may be in the ON state will be automatically turned OFF.

**Example:** "BB:GSM:STAT ON"  
'switches GSM modulation on.

RST value	Resolution	Options	Dependencies	SCPI
OFF	-	B10/B11 and B13 K40 SOURce2 only with second option B9/B10/B11	GSM:STAT ON switches off other standards and digital modulation on the same path (SOURce1 or SOURce2).	Device-specific

**[SOURce<[1]]2>:]BB:GSM:TRIGger:ARM:EXECute**

The command stops signal generation for trigger modes Armed\_Auto and Armed\_Retrigger. A subsequent internal or external trigger event restart signal generation.

This command triggers an event and therefore has no \*RST value and no query form.

**Example:** "BB:GSM:TRIG:SOUR INT"  
 'sets internal triggering.

"BB:GSM:TRIG:SEQ ARET"  
 'sets Armed\_Retrigger mode, i.e. every trigger event causes signal generation to restart.

"BB:GSM:TRIG:EXEC"  
 'executes a trigger, signal generation is started.

"BB:GSM:TRIG:ARM:EXEC"  
 'signal generation is stopped.

"BB:GSM:TRIG:EXEC"  
 'executes a trigger, signal generation is started again.

*RST value	Resolution	Options	SCPI
-	-	B10/B11 and B13 K40 SOURce2 only with second option B9/B10/B11	Device-specific

**[SOURce<[1]]2>:]BB:GSM:TRIGger:EXECute**

The command executes a trigger. The internal trigger source must be selected using the command :BB:GSM:TRIGger:SOURce INTernal and a trigger mode other than AUTO must be selected using the command :BB:GSM:SEQ.

This command triggers an event and therefore has no \*RST value and no query form.

**Example:** "BB:GSM:TRIG:SOUR INT"  
 'sets internal triggering.

"BB:GSM:SEQ RETR"  
 'sets Retrigger mode, i.e. every trigger event causes signal generation to restart.

"BB:GSM:TRIG:EXEC"  
 'executes a trigger.

*RST value	Resolution	Options	SCPI
-	-	B10/B11 and B13 K40 SOURce2 only with second option B9/B10/B11	Device-specific

[SOURce<[1]]2>:]BB:GSM:TRIGger:EXTErnal:CLOCK:DELay 0 ... 2<sup>16</sup>-1 Symbols

The command specifies the trigger delay (expressed as a number of symbols) for external triggering via the clock input. This command applies only for baseband path A and if external clock source (BB:GSM:CLOC:SOUR EXT) and trigger source external clock (BB:GSM:TRIG:SOUR CLOC) are selected.

**Example:** "BB:GSM:CLOC:SOUR EXT"  
 'selects the external clock source. The clock signal must be provided at the CLOCK connector.

"BB:GSM:TRIG:SOUR ECL"  
 'selects an external trigger by means of the external clock.

"BB:GSM:TRIG:EXT:CLOC:DEL 200"  
 'sets a delay of 200 symbols for the trigger.

*RST value	Resolution	Options	SCPI
0 symbols	1 symbol	B10/B11 and B13 K40 SOURce2 only with second option B9/B10/B11	Device-specific

[SOURce<[1]]2>:]BB:GSM:TRIGger:EXTErnal:CLOCK:INHibit 0 ... 2<sup>26</sup>-1 Symbols

The command specifies the number of symbols by which a restart is to be inhibited following a trigger event. This command applies only for baseband path A and if external clock source (BB:GSM:CLOC:SOUR EXT) and trigger source external clock (BB:GSM:TRIG:SOUR CLOC) are selected.

**Example:** "BB:GSM:CLOC:SOUR EXT"  
 'selects the external clock source. The clock signal must be provided at the CLOCK connector.

"BB:GSM:TRIG:SOUR ECL"  
 'selects an external trigger by means of the external clock.

"BB:GSM:TRIG:EXT:CLOC:INH 200"  
 'sets a restart inhibit for 200 symbols following a trigger event.

*RST value	Resolution	Options	SCPI
0 symbols	1	B10/B11 and B13 K40 SOURce2 only with second option B9/B10/B11	Device-specific



**[SOURce<[1]|2>:]BB:GSM:TRIGger[:EXTErnal<[1]|2>]:DELay 0 ... 2<sup>16</sup>-1 Symbols**

The command specifies the trigger delay (expressed as a number of symbols) for external triggering. The numeric suffix to EXTErnal distinguishes between the external trigger via the TRIGGER 1 (suffix 1) and TRIGGER 2 (suffix 2) connector.

**Example:** "BB:GSM:TRIG:SOUR EXT"  
 'selects an external trigger via the TRIGGER 1 connector.  
 "BB:GSM:TRIG:DEL 200"  
 'sets a delay of 200 symbols for the trigger.

*RST value	Resolution	Options	SCPI
0 symbols	1 symbol for CLOCK:SOURce EXT 0.01 symbols for CLOCK:SOURce INT	B10/B11 and B13 K40 SOURce2 only with second option B9/B10/B11	Device-specific

**[SOURce<[1]|2>:]BB:GSM:TRIGger[:EXTErnal<[1]|2>]:INHibit 0 ... 2<sup>26</sup>-1 Symbols**

The command specifies the number of symbols by which a restart is to be inhibited following a trigger event. This command applies only in the case of external triggering. The numeric suffix to EXTErnal distinguishes between the external trigger via the TRIGGER 1 (suffix 1) and TRIGGER 2 (suffix 2) connector.

**Example:** "BB:GSM:TRIG:SOUR EXT"  
 'selects an external trigger via the TRIGGER 1 connector.  
 "BB:GSM:TRIG:INH 200"  
 'sets a restart inhibit for 200 symbols following a trigger event.

*RST value	Resolution	Options	SCPI
0 symbols	1	B10/B11 and B13 K40 SOURce2 only with second option B9/B10/B11	Device-specific

**[SOURce<[1]|2>:]BB:GSM:TRIGger:OBASeband:DELay 0 ... 2<sup>32</sup>-1 Symbols**

The command specifies the trigger delay (expressed as a number of symbols) for triggering by the signal from the second path (two-path instruments only).

**Example:** "BB:GSM:TRIG:SOUR OBAS"  
 'sets for path A the internal trigger executed by the signal from the second path (path B).  
 "BB:GSM:TRIG:OBAS:DEL 200"  
 'sets a delay of 200 symbols for the trigger.

*RST value	Resolution	Options	SCPI
0 symbols	1 symbol for CLOCK:SOURce EXT 0.01 symbols for CLOCK:SOURce INT	B10/B11 and B13 K40 SOURce2 only with second option B9/B10/B11	Device-specific

[SOURce<[1]>:]BB:GSM:TRIGger:OBASeband:INHibit 0 ... 2<sup>32</sup>-1 Symbols

The command specifies the number of symbols by which a restart is to be inhibited following a trigger event. This command applies only for triggering by the second path (two-path instruments only).

**Example:**            "`BB:GSM:TRIG:SOUR OBAS`"  
                           'sets for path A the internal trigger executed by the signal from the second path (path B).  
                           "`BB:GSM:TRIG:OBAS:INH 200`"  
                           'sets a restart inhibit for 200 symbols following a trigger event.

*RST value	Resolution	Options	SCPI
0 symbols	1	B10/B11 and B13 K40 SOURce2 only with second option B9/B10/B11	Device-specific

[SOURce<[1]>:]BB:GSM:TRIGger:OUTPut<[1]...4>:DELay 0 ... 2<sup>24</sup>-1 Symbols

The command defines the delay between the signal on the marker outputs and the start of the frame/slot, expressed in terms of symbols.

Command `:BB:GSM:TRIGger:OUTPut:DELay:FIXed` can be used to restrict the range of values to the dynamic range, i.e. the range within which a delay of the marker signals can be set without restarting the marker and signal.

**Example:**            "`BB:GSM:TRIG:OUTP2:DEL 16`"  
                           'sets a delay of 16 symbols for the signal on connector MARKER 2.

*RST value	Resolution	Options	SCPI
0 symbols	1 symbol	B10/B11 and B13 K40 SOURce2 only with second option B9/B10/B11	Device-specific

[SOURce<[1]>:]BB:GSM:TRIGger:OUTPut:DELay:FIXed ON | OFF

The command restricts the marker delay setting range to the dynamic range. In this range the delay can be set without restarting the marker and signal.

The numeric suffix in `OUTPut` has no significance for this command, since the setting always affects every marker.

**Example:**            "`BB:GSM:TRIG:OUTP:DEL:FIX ON`"  
                           'restricts the marker signal delay setting range to the dynamic range.

*RST value	Resolution	Options	SCPI
OFF	-	B10/B11 and B13 K40 SOURce2 only with second option B9/B10/B11	Device-specific

**[SOURce<[1]2>:]BB:GSM:TRIGger:OUTPut<[1]...4>:DELay:MAXimum**

The command queries the maximum marker delay for setting :BB:GSM:TRIGger:OUTPut:DELay:FIXed ON.

The command is a query only and therefore has no \*RST value.

**Example:** "BB:GSM:TRIG:OUTP:DEL:FIX ON"  
 'restricts the marker signal delay setting range to the dynamic range.  
 "BB:GSM:TRIG:OUTP:DEL:MAX"  
 'queries the maximum of the dynamic range.

Response: "2000"  
 'the maximum for the marker delay setting is 2000 symbols.

*RST value	Resolution	Options	SCPI
-	-	B10/B11 and B13 K40 SOURce2 only with second option B9/B10/B11	Device-specific

**[SOURce<[1]2>:]BB:GSM:TRIGger:OUTPut<[1]...4>:DELay:MINimum**

The command queries the minimum marker delay for setting :BB:GSM:TRIGger:OUTPut:DELay:FIXed ON..

The command is a query only and therefore has no \*RST value.

**Example:** "BB:GSM:TRIG:OUTP:DEL:FIX ON"  
 'restricts the marker signal delay setting range to the dynamic range.  
 "BB:GSM:TRIG:OUTP:DEL:MIN"  
 'queries the minimum of the dynamic range.

Response: "0"  
 'the minimum for the marker delay setting is 0 symbols.

*RST value	Resolution	Options	SCPI
-	-	B10/B11 and B13 K40 SOURce2 only with second option B9/B10/B11	Device-specific

[SOURce<[1]2>:]BB:GSM:TRIGger:OUTPut<[1]...4>:MODE SDEF | FRAMe | SLOt | PULSe | PATtern | RATio

The command defines the signal for the selected marker output.

**Parameter:** As defined in slots  
The marker defined in the burst editor is used.

**SLOt**

A slot clock with the slot period specified using command SOUR:BB:GSM:TRIG:OUTP:PER:SLOt is generated on the output connector. The marker signal is generated after every specified number of slots. It is important to be aware of the variation in the GSM/EDGE slot length between 156 and 157 symbols. At a slot length of 156 symbols, a period of 1 symbol and a symbol rate of 270.833 ksymb/s the clock is 0.577 ms, and at 157 symbols it is 0.580 ms.

**FRAMe**

A frame clock with the frame period specified using command SOUR:BB:GSM:TRIG:OUTP:PER:FRAM is generated on the output connector. The marker signal is generated after every specified number of frames. A GSM/EDGE frame has 1250 symbols. At a symbol rate of 270.833 ksymb/s and a period of 1 the clock is 4.615 ms.

**PULSe**

A pulsed marker signal is generated. The pulse frequency (= symbol rate/divider) is defined with the SOUR:BB:GSM:TRIG:OUTP:PULS:DIV command and can be queried with the SOUR:BB:GSM:TRIG:OUTP:PULS:FREQ? command.

**PATtern**

A marker signal is generated with the aid of a user-definable bit pattern. The bit pattern is entered with the aid of command SOURce:BB:GSM:TRIGg:OUTP:PATT. The bit pattern is a maximum of 32 bits long.

**RATio**

A regular marker signal corresponding to the Time Off / Time On specifications in the commands SOUR:BB:GSM:TRIGge:OUTP:OFFT and SOUR:BB:GSM:TRIGg:OUTP:ONT is generated.

**Example:** "BB:GSM:TRIG:OUTP2:MODE PULS"  
'selects the pulsed marker signal on output MARKER 2.

*RST value	Resolution	Options	SCPI
FRAMe	-	B10/B11 and B13 K40 SOURce2 only with second option B9/B10/B11	Device-specific

**[SOURce<[1]>:]BB:GSM:TRIGger:OUTPut<[1]...4>:OFFTime 1 ... 2<sup>24</sup>-1 symbols**

The command sets the number of symbols in a period (ON time + OFF time) during which the marker signal in setting `SOURce:BB:GSM:TRIGger:OUTPut:MODE RATio` on the marker outputs is OFF.

**Example:** `"BB:GSM:TRIG:OUTP2:OFFT 20"`  
'sets an OFF time of 20 symbols for marker signal 2 on path A.

*RST value	Resolution	Options	SCPI
1 Symbol	1	B10/B11 and B13 K40 SOURce2 only with second option B9/B10/B11	Device-specific

**[SOURce<[1]>:]BB:GSM:TRIGger:OUTPut<[1]...4>:ONTime 1 ... 2<sup>24</sup>-1 symbols**

The command sets the number of symbols in a period (ON time + OFF time) during which the marker signal in setting `SOURce:BB:GSM:TRIGger:OUTPut:MODE RATio` on the marker outputs is ON.

**Example:** `"BB:GSM:TRIG:OUTP2:ONT 20"`  
'sets an ON time of 20 symbols for marker 2 on path A.

*RST value	Resolution	Options	SCPI
1 Symbol	1	B10/B11 and B13 K40 SOURce2 only with second option B9/B10/B11	Device-specific

**[SOURce<[1]>:]BB:GSM:TRIGger:OUTPut<[1]...4>:PATTern #B0,1... #B111...1,64**

The command defines the bit pattern used to generate the marker signal in the setting `SOURce:BB:GSM:TRIGger:OUTPut:MODE PATTern` 0 is marker off, 1 is marker on.

**Example:** `"BB:GSM:TRIG:OUTP2:PATT #H81,8"`  
'sets a bit pattern.  
`"BB:GSM:TRIG:OUTP2:MODE PATT"`  
'activates the marker signal according to a bit pattern on output MARKER 2.

*RST value	Resolution	Options	SCPI
0		B10/B11 and B13 K40 SOURce2 only with second option B9/B10/B11	Device-specific

**[SOURce<[1]|2>:]BB:GSM:TRIGger:OUTPut<[1]...4>:PERiod[:FRAMe] 1... 2^26-1**

The command sets the repetition rate for the frame clock at the marker outputs.

**Example:** "BB:GSM:TRIG:OUTP2:MODE FRAM"  
 'sets the frame clock for the signal on connector MARKER 2.

"BB:GSM:TRIG:OUTP2:PER 16"  
 'sets a period of 16 frames, i.e. the marker signal is repeated every 16th frame.

*RST value	Resolution	Options	SCPI
1	1	B10/B11 and B13 K40 SOURce2 only with second option B9/B10/B11	Device-specific

**[SOURce<[1]|2>:]BB:GSM:TRIGger:OUTPut<[1]...4>:PERiod:SLOT 1... 2^26-1**

The command sets the repetition rate for the slot clock at the marker outputs.

**Example:** "BB:GSM:TRIG:OUTP2:MODE SLOT"  
 'sets the slot clock for the signal on connector MARKER 2.

"BB:GSM:TRIG:OUTP2:PER:SLOT 16"  
 'sets a period of 16 slots, i.e. the marker signal is repeated every 16th slot.

*RST value	Resolution	Options	SCPI
1	1	B10/B11 and B13 K40 SOURce2 only with second option B9/B10/B11	Device-specific

**[SOURce<[1]|2>:]BB:GSM:TRIGger:OUTPut<[1]...4>:PULSe:DIVider 2 ... 2^10**

The command sets the divider for the pulsed marker signal in the setting SOURce:BB:GSM:TRIGger:OUTPut:MODE PULSe. The pulse frequency is derived by dividing the symbol rate by the divider.

**Example:** "BB:GSM:TRIG:OUTP2:PULS:DIV 2"  
 'sets the divider for the path A marker signal on output MARKER 2 to the value 2.

"BB:GSM:TRIG:OUTP2:FREQ?"  
 'queries the resulting pulse frequency of the marker signal

Response: "66 000"  
 'the resulting pulse frequency is 66 kHz.

*RST value	Resolution	Options	SCPI
2	1	B10/B11 and B13 K40 SOURce2 only with second option B9/B10/B11	Device-specific

**[SOURce<[1]|2>:]BB:GSM:TRIGger:OUTPut<[1]...4>:PULSe:[FREQuency]?**

The command queries the pulse frequency of the pulsed marker signal in the setting SOUR:BB:GSM:TRIG:OUTP:MODE PULS. The pulse frequency is derived by dividing the symbol rate by the divider. The divider is defined with command SOUR:BB:GSM:TRIG:OUTP:PULS:DIV.

The command is a query only and therefore has no \*RST value.

**Example:** "BB:GSM:TRIG:OUTP2:PULS:DIV 4"  
'sets the divider for the path A marker signal on output MARKER 2 to the value 4.

"BB:GSM:TRIG:OUTP2:MODE PULS"  
'enables the pulsed marker signal

"BB:GSM:TRIG:OUTP2:PULS:FREQ?"  
'queries the resulting pulse frequency for the marker signal.

Response: "33 000"  
'the resulting pulse frequency is 33 kHz.

*RST value	Resolution	Options	SCPI
-	-	B10/B11 and B13 K40 SOURce2 only with second option B9/B10/B11	Device-specific

**[SOURce<[1]|2>:]BB:GSM:TRIGger:RMODE**

The command queries the status of frame generation for all trigger modes with GSM/EDGE modulation on.

The command is a query command and therefore has no \*RST value.

**Parameter: RUN**  
the GSM/EDGE signal is generated. A trigger event occurred in the triggered mode.

**STOP**  
the GSM/EDGE signal is not generated. A trigger event did not occur in the triggered modes, or signal generation was stopped by the command :BB:GSM:TRIG:ARM:EXECute (armed trigger modes only).

**Example:** "SOUR2:BB:GSM:TRIG:SOUR EXT"  
'sets external triggering via the TRIGGER 1 connector for path B of a two-path instrument.

"SOUR2:BB:GSM:TRIG:MODE ARET"  
'selects the Armed\_Retrigger mode.

"SOUR2:BB:GSM:TRIG:RMODE?"  
'queries the status of frame generation.

Response: "RUN"  
'the frame is generated, an external trigger was executed.

*RST value	Resolution	Options	SCPI
-	-	B10/B11 and B13 K40 SOURce2 only with second option B9/B10/B11	Device-specific

[SOURce<[1]|2>:]BB:GSM:TRIGger:SLENgth 1 ... (2^32-1) Symbols

The command defines the length of the signal sequence to be output in the **Single** trigger mode. The unit is defined with command SOUR:BB:GSM:TRIG:SLUNit. It is possible to output deliberately just part of a frame, an exact sequence of a frame, or a defined number of repetitions of a frame.

**Example:**        "SOUR2:BB:GSM:SEQ SING"  
                       'sets trigger mode Single.

                      "SOUR2:BB:GSM:TRIG:SLUN SYMB"  
                       'sets unit symbol for the entry of signal duration.

                      "SOUR2:BB:GSM:TRIG:SLEN 200"  
                       'sets a signal duration of 200 symbols. 200 symbols will be output after the next trigger event.

*RST value	Resolution	Options	SCPI
1 Frame	-	B10/B11 and B13 K40 SOURce2 only with second option B9/B10/B11	Device-specific

[SOURce<[1]|2>:]BB:GSM:TRIGger:SLUNit FRAME | SYMBol

The command defines the unit for the entry of the length of the signal sequence (SOUR:BB:GSM:TRIG:SLEN) to be output in the **Single** trigger mode (SOUR:BB:GSM:SEQ SING).

**Example:**        "SOUR2:BB:GSM:SEQ SING"  
                       'sets trigger mode Single.

                      "SOUR2:BB:GSM:TRIG:SLUN FRAM"  
                       'sets unit frame for the entry of signal duration.

                      "SOUR2:BB:GSM:TRIG:SLEN 2"  
                       'sets a signal duration of 2 frames. The current frame will be output twice after the next trigger event.

*RST value	Resolution	Options	SCPI
FRAMe	-	B10/B11 and B13 K40 SOURce2 only with second option B9/B10/B11	Device-specific



[SOURce<[1]|2>:]BB:GSM:TRIGger:SOURce INTernal | EXTernal | BEXTernal | OBASeband | ECLock

The command selects the trigger source.

- Parameter:**     **INTernal**  
Triggering is executed by means of the Trigger command in the case of remote control, and by means of **Execute Trigger** in the case of manual operation.
- EXTernal**  
Triggering is executed by means of the signal on the TRIGGER 1 connector.
- BEXTernal**  
Triggering is executed by means of the signal on the TRIGGER 2 connector.
- OBASeband**  
Triggering is executed by means of the signal from the second path (two-path instruments only).
- ECLock**  
Triggering is executed by means of the signal on the CLOCK connector. This signal is also used as clock. The selection is only available for baseband path A and if external clock source (:BB:GSM:CLOC:SOUR EXT) is selected.

**Example:**     "BB:GSM:TRIG:SOUR INT"  
                  'sets internal triggering.

*RST value	Resolution	Options	SCPI
INTernal	-	B10/B11 and B13 K40 SOURce2 only with second option B9/B10/B11	Device-specific

# SOURce:BB:IMPairment Subsystem

This subsystem contains the commands for the digital I/Q impairments. Included in this section is also the description of command `SOURce:BB:IQOutput:SOURce` that determined the source for the I/Q output connectors.

Digital I/Q impairments can be activated in the case of two-path instruments with a second R&S SMATE-B13 option (Baseband Main Module) and one of the options R&S SMATE-B10/B11 (Baseband Generator), R&S SMATE-B17 (External Baseband Input) or R&S SMATE-K62 (Noise Generator).

SOURce[1] = Path A

SOURce2 = Path B

Command	Parameters	Default unit	Remark
[SOURce<[1] 2>:]BB:IMPairment:IQRatio	-1 dB ... +1 dB	dB	
[SOURce<[1] 2>:]BB:IMPairment:LEAKage:I	0 ... 50.0 PCT	PCT	
[SOURce<[1] 2>:]BB:IMPairment:LEAKage:Q	0 ... 50.0 PCT	PCT	
[SOURce<[1] 2>:]BB:IMPairment:OPTimization:STATe	ON   OFF		
[SOURce<[1] 2>:]BB:IMPairment:QUADrature[:ANGLE]	-10.0...10.0 DEG	DEG	
[SOURce<[1] 2>:]BB:IMPairment:STATe	ON   OFF		
[SOURce<[1] 2>:]BB:IQGain	AUTO   DBM3   DB0   DB3   DB6		
[SOURce:]BB:IQOutput:SOURce	A   B		

## [SOURce<[1]|2>:]BB:IMPairment:IQRatio -1 dB ... +1 dB

This command sets the ratio of I modulation to Q modulation (amplification “imbalance”). The input may be either in dB or %. The resolution is 0.001 dB, an input in percent is rounded to the closest valid value in dB. A query returns the value in dB.

**Examples:**       "BB:IMP:IQR 3 PCT"  
                      'sets the imbalance to 3 percent.

"BB:IMP:IQR?"  
                      'queries the imbalance

Response: "0.259000"  
                      'the value is returned in dB

"BB:IMP:IQR 1"  
                      'sets the imbalance to 1 dB.

*RST value	Resolution	Options	SCPI
0 dB	0.001 dB	B13 SOURce2 only with second B13 option and at least one of options B10/B11, B17 or K62.	Device-specific

**[SOURce<[1]|2>:]BB:IMPairment:LEAKage:I 0 ... 50 PCT**

This command sets the carrier leakage amplitude for the I-signal component.

**Example:** "BB:IMP:LEAK:I 3 PCT"  
'sets the leakage for the I-component to 3 percent'.

*RST value	Resolution	Options	SCPI
0 PCT	0.05 PCT	B13 SOURce2 only with second B13 option and at least one of options B10/B11, B17 or K62.	Device-specific

**[SOURce<[1]|2>:]BB:IMPairment:LEAKage:Q 0 ... 50 PCT**

This command sets the carrier leakage amplitude for the Q-signal component.

**Example:** "BB:IMP:LEAK:Q 3 PCT"  
'sets the leakage for the Q-component to 3 percent'.

*RST value	Resolution	Options	SCPI
0 PCT	0.05 PCT	B13 SOURce2 only with second B13 option and at least one of options B10/B11, B17 or K62.	Device-specific

**[SOURce<[1]|2>:]BB:IMPairment:OPTimization:STATe ON | OFF**

This command activates and deactivates internal compensation of signal distortions by the I/Q modulator.

**Example:** "BB:IMP:OPT:STAT ON"  
'activates internal compensation of signal distortions for Path A'.

*RST value	Resolution	Options	SCPI
OFF	-	B13 SOURce2 only with second B13 option and at least one of options B10/B11, B17 or K62.	Device-specific

**[SOURce<[1]|2>:]BB:IMPairment:QUADrature[:ANGLe] -10.0 ... 10.0 DEG**

This command sets the quadrature offset for the digital I/Q signal.

**Example:** "BB:IMP:QUAD:ANGL -5DEG"  
'sets the quadrature offset to -5 degrees.

*RST value	Resolution	Options	SCPI
0 DEG	0.02 DEG	B13 SOURce2 only with second B13 option and at least one of options B10/B11, B17 or K62.	Device-specific

[SOURce<[1]|2>:]BB:IMPairment:STATe ON | OFF

The command activates (ON) and deactivates (OFF) the three impairment or correction values LEAKage, QUADrature and IQRatio for the digital baseband signal prior to input into the I/Q modulator

**Example:** "BB:IMP:STAT OFF"  
'deactivates digital impairment.

*RST value	Resolution	Options	SCPI
OFF	-	B13 SOURce2 only with second B13 option and at least one of options B10/B11, B17 or K62.	Device-specific

[SOURce<[1]|2>:]BB:IQGain AUTO | DBM3 | DB0 | DB3 | DB6

This command specifies the baseband gain for the internal or external baseband signal.

Thus, the modulation of the I/Q modulator can be optimized for any measurement requirement. The gain settings for an external analog wideband signal (**Analog Wideband I/Q In**) are performed with command :SOURce:IQ:GAIN

**Parameters:** **AUTO**  
Activates automatic setting. The modulation is automatically optimized for the internally set baseband signal.

**DBM3**  
Activates -3 dB gain. With this setting, signal distortions are minimized.

**DB0**  
Activates 0 dB gain (standard settings).

**DB3**  
Activates 3 dB gain. This setting is recommended for high 3GPP ACLR.

**DB6**  
Activates 6 dB gain. With this setting, signal noise is minimized.

**Example:** "IQ:SOUR BAS"  
'selects the internal baseband signal as the input signal of the I/Q modulator.

"BB:IQG DB6"  
'sets gain 6dB (best for low noise).

*RST value	Resolution	Options	SCPI
Auto	0.01 dB	SOURce2 only with second B13 option and at least one of options B10/B11, B17 or K62.	Device-specific

[SOURce:]BB:IQOutput:SOURce A | B

This command selects the output signal at the I/Q OUT connectors for a two-path instrument.

**Example:** "BB:IQO:SOUR A"  
 'the I/Q components of path A baseband signal are output at the I/Q OUT connectors.

*RST value	Resolution	Options	SCPI
A		Two B13 options and at least one of options B10/B11, B17 or K62.	Device-specific

# SOURce:BB:MCCW Subsystem

This subsystem contains the commands for setting the Multicarrier CW signals.

The numeric suffix to SOURce distinguishes between multicarrier generation for path A and path B in the case of two-path instruments:

SOURce<1> = path A

SOURce2 = path B

The keyword SOURce is optional in the case of commands for path A and can be omitted. For path B the command must contain the keyword with suffix 2.

Command	Parameter	Default unit	Note
[SOURce<[1] 2>:]BB:MCCW:CARRier:COUNT	1 ... 8192	-	
[SOURce<[1] 2>:]BB:MCCW:CARRier:LIST:PHASe	0° ... 360°, 0° ... 360°, ...	RAD	
[SOURce<[1] 2>:]BB:MCCW:CARRier:LIST:POWer	-80... 0 dB , -80 ... 0 dB, ...	dB	
[SOURce<[1] 2>:]BB:MCCW:CARRier:LIST:STATe	ON   OFF, ON   OFF, ...		
[SOURce<[1] 2>:]BB:MCCW:CARRier:PHASe	<index>, 0...360DEG	RAD	
[SOURce<[1] 2>:]BB:MCCW:CARRier:POWer	<index>, -80 ... 0 dB	dB	
[SOURce<[1] 2>:]BB:MCCW:CARRier:SPACing	0 Hz...50 MHz	Hz	
[SOURce<[1] 2>:]BB:MCCW:CARRier:STATe	<index>, ON   OFF		
[SOURce<[1] 2>:]BB:MCCW:CFACTOR	0 ... 100 dB	dB	
[SOURce<[1] 2>:]BB:MCCW:CFACTOR:ACTual	0 ... 100 dB	dB	
[SOURce<[1] 2>:]BB:MCCW:CFACTOR:MODE	OFF   CHIRp   SLOW		
[SOURce<[1] 2>:]BB:MCCW:CLOCK			Query only
[SOURce<[1] 2>:]BB:MCCW:CLOCK:MODE	SAMPlE   MSAMPlE		
[SOURce<[1] 2>:]BB:MCCW:CLOCK:MULTIplier	1 ... 64		
[SOURce<[1] 2>:]BB:MCCW:CLOCK:SOURce	INTernal   EXTernal		
[SOURce<[1] 2>:]BB:MCCW:EDIT:CARRier:EXECute			No query
[SOURce<[1] 2>:]BB:MCCW:EDIT:CARRier:PHASe[:START]	0...360DEG	RAD	
[SOURce<[1] 2>:]BB:MCCW:EDIT:CARRier:PHASe:STEP	-360...360DEG	RAD	
[SOURce<[1] 2>:]BB:MCCW:EDIT:CARRier:POWer[:START]	-80 ... 0 dB	dB	
[SOURce<[1] 2>:]BB:MCCW:EDIT:CARRier:POWer:STEP	-80 ... 80 dB	dB	
[SOURce<[1] 2>:]BB:MCCW:EDIT:CARRier:START	<carrier_index>		
[SOURce<[1] 2>:]BB:MCCW:EDIT:CARRier:STATe	ON   OFF		
[SOURce<[1] 2>:]BB:MCCW:EDIT:CARRier:STOP	<carrier_index>		
[SOURce<[1] 2>:]BB:MCCW:PRESet	-		
[SOURce<[1] 2>:]BB:MCCW:SEquence	AUTO / RETRigger / AAUTO / ARETrigger / SINGLE		
[SOURce<[1] 2>:]BB:MCCW:STATe	ON   OFF		
[SOURce<[1] 2>:]BB:MCCW:TRIGger:ARM:EXECute			No query

Command	Parameter	Default unit	Note
[SOURce<[1]>:]BB:MCCW:TRIGger:EXECute			No query
[SOURce<[1]>:]BB:MCCW:TRIGger[:EXTernal<[1]>]:DELay	0 ... 2 <sup>32</sup> -1 Samples	-	
[SOURce<[1]>:]BB:MCCW:TRIGger[:EXTernal<[1]>]:INHibit	0 ... 2 <sup>32</sup> -1 Samples	-	
[SOURce<[1]>:]BB:MCCW:TRIGger:OBASeband:DELay	0 ... 2 <sup>32</sup> -1 Samples	-	
[SOURce<[1]>:]BB:MCCW:TRIGger:OBASeband:INHibit	0 ... 2 <sup>32</sup> -1 Samples	-	
[SOURce<[1]>:]BB:MCCW:TRIGger:OUTPut<[1]...4>:DELay	0 ... 2 <sup>20</sup> -1 Samples		
[SOURce<[1]>:]BB:MCCW:TRIGger:OUTPut:DELay:FIXed	ON   OFF		
[SOURce<[1]>:]BB:MCCW:TRIGger:OUTPut<[1]...4>:DELay:MAX?			Query only
[SOURce<[1]>:]BB:MCCW:TRIGger:OUTPut<[1]...4>:DELay:MIN?			Query only
[SOURce<[1]>:]BB:MCCW:TRIGger:OUTPut<[1]...4>:MODE	REStart   PULSe   PATTErn   RATio		
[SOURce<[1]>:]BB:MCCW:TRIGger:OUTPut<[1]...4>:OFFTime	1 ... max. wavelength -1 sample		
[SOURce<[1]>:]BB:MCCW:TRIGger:OUTPut<[1]...4>:ONTIME	1 ... max. wavelength -1 sample		
[SOURce<[1]>:]BB:MCCW:TRIGger:OUTPut<[1]...4>:PATTErn	#B0,1 ... #B111...1,32		
[SOURce<[1]>:]BB:MCCW:TRIGger:OUTPut<[1]...4>:PULSe:DIVider	2...2 <sup>10</sup>		
[SOURce<[1]>:]BB:MCCW:TRIGger:OUTPut<[1]...4>:PULSe:FREQ			Query only
[SOURce<[1]>:]BB:MCCW:TRIGger:RMODE			Query only
[SOURce<[1]>:]BB:MCCW:TRIGger:SLENgth	1 ... 2 <sup>32</sup> -1 Samples		
[SOURce<[1]>:]BB:MCCW:TRIGger:SOURce	INTernal   EXTernal   BEXTernal   OBASeband		

**[SOURce<[1]>:]BB:MCCW:CARRier:COUNT 1 ... 8192**

The command sets the number of carriers in the Multicarrier CW signal. The total bandwidth (*Number of carriers - 1*) \* *Carrier spacing* is 80 MHz. The number of carriers entered therefore defines the maximum carrier spacing (:BB:MCCW:CARRier:SPACing).

**Example:** "BB:MCCW:CARR:COUNT 10"  
'sets 10 CW carriers for the multicarrier signal.

*RST value	Resolution	Options	Dependencies	SCPI
64	1	B10/B11 and B13 K61 SOURce2 only with second option B9/B10/B11	The carrier spacing (:BB:MCCW:CARRier:SPACing) is reduced if the total bandwidth of 80 MHz is not respected when entering the number of carriers.	Device-specific

**[SOURce<[1]>:]BB:MCCW:CARRier:LIST:PHASe 0 ... 360 DEG[, 0 ... 360 DEG].**

The command sets the start phase of the carrier with the aid of a value list. The first value in the list is assigned to the carrier with index 0, the second value to the carrier with index 1, etc. The maximum length corresponds to the maximum number of multicarriers. There is no need to enter all the values every time. Values not set by the value list are set with the default values provided they have already been explicitly set by a previous command. If this is the case, the values continue to apply until overwritten.

If the query is expanded by using the two parameters <start> and <count>, the value list is read out in smaller sections. Start is expressed in position of bit, count in number of values. Without the parameters all values are always read out starting from the first value.

**Example:** "BB:MCCW:CARR:LIST:PHAS 90 DEG, 90 DEG, 90 DEG, 80 DEG"  
 'sets a start phase for carriers 0, 1, 2 and 3.  
 "BB:MCCW:CARR:LIST:PHAS 2, 3"  
 'queries the phase of carrier 1, 2 and 3.  
 Response: "90,90,80"

*RST value	Resolution	Options	SCPI
0 DEG	0.01 DEG	B10/B11 and B13 K61 SOURce2 only with second option B9/B10/B11	Device-specific

**[SOURce<[1]>:]BB:MCCW:CARRier:LIST:POWer - 80 dB ... 0 dB[, - 80 dB ... 0 dB]**

The command sets the power of the carrier with the aid of a value list. The first value in the list is assigned to the carrier with index 0, the second value to the carrier with index 1, etc. The maximum length corresponds to the maximum number of multicarriers. There is no need to enter all the values every time. Values not set by the value list are set with the default values provided they have already been explicitly set by a previous command. If this is the case, the values continue to apply until overwritten.

If the query is expanded by using the two parameters <start> and <count>, the value list is read out in smaller sections. Start is expressed in position of bit, count in number of values. Without the parameters all values are always read out starting from the first value.

**Example:** "BB:MCCW:CARR:LIST:POW -65 dB, -30 dB, -50 dB, ..."  
 'sets the power of carrier 0 to -65 dB, carrier 1 to -30 dB and so on.  
 "BB:MCCW:CARR:LIST:POW 2, 2"  
 'queries the power of carrier 1 and 2.  
 Response: "-30, -50"

*RST value	Resolution	Options	SCPI
0 dB	0.01 dB	B10/B11 and B13 K61 SOURce2 only with second option B9/B10/B11	Device-specific



**[SOURce<[1]]2>:]BB:MCCW:CARRier:LIST:STATe** ON | OFF, ON | OFF, ...

The command switches the carrier on or off with the aid of a value list. The first value in the list is assigned to the carrier with index 0, the second value to the carrier with index 1, etc. The maximum length corresponds to the maximum number of multicarriers. There is no need to enter all the values every time. Values not set by the value list are set with the default values provided they have already been explicitly set by a previous command. If this is the case, the values continue to apply until overwritten..

If the query is expanded by using the two parameters <start> and <count>, the value list is read out in smaller sections. Start is expressed in position of bit, count in number of values. Without the parameters all values are always read out starting from the first value.

**Example:** "BB:MCCW:CARR:LIST:STAT ON, OFF, ON, . . . ."  
'switches carrier 0 on, carrier 1 off, etc.

"BB:MCCW:CARR:LIST:POW 2, 2"  
'queries the states of carrier 1 and 2.

Response: "0, 1"

*RST value	Resolution	Options	SCPI
ON	-	B10/B11 and B13 K61 SOURce2 only with second option B9/B10/B11	Device-specific

**[SOURce<[1]]2>:]BB:MCCW:CARRier:PHASe** <carrier\_index>, 0 ... 360 DEG.

The command sets the start phase of the selected carrier. The carrier is selected by the numerical parameter <carrier\_index>.

The phase settings are only valid if optimization of the crest factor is disabled  
(:SOURce:BB:MCCW:CFACTOR:MODE OFF).

**Example:** "BB:MCCW:CARR:PHAS 15, 90 DEG"  
'sets a start phase of 90° for carrier 15.

*RST value	Resolution	Options	SCPI
0 DEG	0.01 DEG	B10/B11 and B13 K61 SOURce2 only with second option B9/B10/B11	Device-specific

**[SOURce<[1]]2>:]BB:MCCW:CARRier:POWer** <carrier\_index>, 80 dB ... 0 dB

The command sets the power of the selected carrier. The carrier is selected by the numerical parameter <carrier\_index>.

**Example:** "BB:MCCW:CARR:POW 15, -50 dB"  
'sets the power of carrier 15 to -50 dB.

*RST value	Resolution	Options	SCPI
0 dB	0.01 dB	B10/B11 and B13 K61 SOURce2 only with second option B9/B10/B11	Device-specific

[SOURCE<[1]>:]BB:MCCW:CARRIER:SPACING 0 Hz ... 50 MHz

The command sets the carrier spacing. The carriers are generated symmetrically around the RF carrier. The total bandwidth (*Number of carriers - 1*) \* *Carrier spacing* is 80 MHz. The maximum carrier spacing that can be set is dependent on the chosen number of carriers

**Example:** "BB:MCCW:CARR:SPAC 10 MHz"  
'sets a carrier spacing of 10 MHz.

*RST value	Resolution	Options	Dependencies	SCPI
10 kHz	0.01 Hz	B10/B11 and B13 K61 SOURCE2 only with second option B9/B10/B11	The maximum carrier spacing is automatically reduced so that the maximum total bandwidth of 80 MHz is not exceeded on entering the number of carriers (:BB:MCCW:CARRIER:COUNT).	Device-specific

[SOURCE<[1]>:]BB:MCCW:CARRIER:STATE <carrier\_index>, ON | OFF

The command switches the selected carrier on or off. The carrier is selected by the numerical parameter <carrier\_index>. The counting in remote control differs from the numbers in the carrier table. Index 0 corresponds to number 1 (first line) in the table. Therefore, switching the state of the channel via remote control always switches the state of channel index + 1 in the table.

**Example:** "BB:MCCW:CARR:STAT 15, ON"  
'switches carrier 16 on.

*RST value	Resolution	Options	SCPI
ON	-	B10/B11 and B13 K61 SOURCE2 only with second option B9/B10/B11	Device-specific

[SOURCE<[1]>:]BB:MCCW:CFACTOR 0 ... 100 dB

The command sets the desired crest factor for the multicarrier signal on selection of the command SOURCE:BB:MCCW:CFACTOR:MODE SLOW.

**Example:** "BB:MCCW:CFAC:MODE SLOW"  
'sets the Target Crest optimization mode.  
"BB:MCCW:CFAC 10 dB"  
'sets the desired crest factor to 10 dB.

*RST value	Resolution	Options	SCPI
3 dB	0.01 dB	B10/B11 and B13 K61 SOURCE2 only with second option B9/B10/B11	Device-specific

[SOURce<[1]|2>:]BB:MCCW:CFACtor:ACTual 0 ... 100 dB

The command queries the current crest factor for the multicarrier signal.

Optimization (SOURce:BB:MCCW:CFACtor:MODE SLOW) can be cancelled at any time (SOURce:BB:MCCW:CFACtor:MODE OFF), and the current value at that moment is then used.

The command is a query only and therefore has no \*RST value.

**Example:** "BB:MCCW:CFAC:MODE SLOW"  
'sets the Target Crest optimization mode.

"BB:MCCW:CFAC 10 dB"  
'sets the desired crest factor to 10 dB.

"BB:MCCW:CFAC:ACT?"  
'queries the current crest factor.

Response: "14 dB"  
'the current value of the crest factor is 14 dB.

*RST value	Resolution	Options	SCPI
-	-	B10/B11 and B13 K61 SOURce2 only with second option B9/B10/B11	Device-specific

[SOURce<[1]|2>:]BB:MCCW:CFACtor:MODE OFF | CHIRp | SLOW

The command sets the mode by which automatic settings will minimize the crest factor or hold it at a chosen value.

**Parameter:** OFF  
Crest factor optimization is switched off. The carrier PHASE setting has an effect.

**CHIRp**  
The crest factor is very rapidly optimized to < 3 dB for multicarrier signals so that all carriers are switched on and have the same amplitude. The computation time is independent of the number of carriers. In other carrier configurations the achievable crest factor is worse.

**SLOW**  
The crest factor entered using SOURce:BB:MCCW:CFACtor is maintained for all carrier configurations by means of automatic settings. The computation time depends on the number of carriers and on the crest factor that has been set. Computation time increases only when the number of carriers exceeds 256 and the crest factor is above 4 dB.

**Example:** "BB:MCCW:CFAC:MODE OFF"  
'switches off automatic crest factor optimization. The setting SOUR:BB:MCCW:CARR:PHAS has an effect.

*RST value	Resolution	Options	SCPI
FAST	-	B10/B11 and B13 K61 SOURce2 only with second option B9/B10/B11	Device-specific

[SOURce<[1]|2>:]BB:MCCW:CLOCK?

The command queries the output clock rate. The output clock rate depends on the number of carriers and the selected carrier spacing.

The command is a query only and therefore has no \*RST value.

**Example:** "BB:MCCW:CLOC?"  
'queries the output clock rate.

Response: "256 000 000"  
'the output clock rate is 256 MHz.

*RST value	Resolution	Options	SCPI
-	-	B10/B11 and B13 K61 SOURce2 only with second option B9/B10/B11	Device-specific

[SOURce<[1]|2>:]BB:MCCW:CLOCK:MODE SAMPLE | MSAMPLE

The command enters the type of externally supplied clock (:BB:MCCW:CLOCK:SOURCE EXTERNAL) .. When MSAMPLE is used, a multiple of the sample clock is supplied via the CLOCK connector and the sample clock is derived internally from this. The multiplier is entered with the command BB:MCCW:CLOCK:MULTIPLIER.

With this command the only numerical suffix allowed for SOURCE is 1, since the external clock source is permanently allocated to path A.

**Example:** "BB:MCCW:CLOCK:MODE SAMP"  
'selects clock type **Sample**, i.e. the supplied clock is a sample clock.

*RST value	Resolution	Options	SCPI
SAMPLE	-	B10/B11 and B13 K61 SOURce2 only with second option B9/B10/B11	Device-specific

[SOURce<[1]|2>:]BB:MCCW:CLOCK:MULTIplier 1 ... 64

The command specifies the multiplier for clock type **Multiple Samples** (:BB:MCCW:CLOCK:MODE MSAM) in the case of an external clock source.

With this command the only numerical suffix allowed for SOURce is 1, since the external clock source is permanently allocated to path A.

**Example:** "BB:MCCW:CLOC:SOUR EXT"  
 'selects the external clock source. The clock is supplied via the CLOCK connector.

"BB:MCCW:CLOC:MODE MSAM"  
 'selects clock type **Multiple Samples**, , i.e. the supplied clock has a rate which is a multiple of the sample rate.

"BB:MCCW:CLOC:MULT 12"  
 'the multiplier for the external clock rate is 12.

*RST value	Resolution	Options	SCPI
4	1	B10/B11 and B13 K61 SOURce2 only with second option B9/B10/B11	Device-specific

[SOURce<[1]|2>:]BB:MCCW:CLOCK:SOURce INTernal | EXTernal

The command selects the source for the digital modulation clock.

Selecting EXTernal is only possible for path A, since the external clock source is permanently allocated to path A.

**Parameter:** **INTernal**  
 The internal clock reference is used.

**EXTernal**  
 The external clock reference is supplied to the CLOCK connector.

**Example:** "BB:MCCW:CLOC:SOUR EXT"  
 'selects an external clock reference for path A. The clock is supplied via the CLOCK connector.

*RST value	Resolution	Options	SCPI
INTernal		B10/B11 and B13 K61 SOURce2 only with second option B9/B10/B11	Device-specific

[SOURce<[1]|2>:]BB:MCCW:EDIT:CARRier:EXECute

The command adopts the settings for the carrier range which has been defined using the :BB:MCCW:EDIT:CARR: commands.

**Example:** "BB:MCCW:EDIT:CARR:STAR 4"  
 'the carrier range starts at carrier 4.  
 "BB:MCCW:EDIT:CARR:STOP 400"  
 'the carrier range stops at carrier 400.  
 "BB:MCCW:EDIT:CARR:STAT ON"  
 'sets all the carriers in the carrier range to ON.  
 "BB:MCCW:EDIT:CARR:EXEC"  
 'adopts the settings for all the carriers in the carrier range.  
 "BB:MCCW:STAT"  
 'starts generation of the multicarrier signal. Carriers 4 to 400 are in the ON state.

RST value	Resolution	Options	SCPI
		B10/B11 and B13 K61 SOURce2 only with second option B9/B10/B11	Device-specific

[SOURce<[1]|2>:]BB:MCCW:EDIT:CARRier:PHASe[:START] 0 ... 360 DEG.

The command sets the start phase for the individual carriers in the defined carrier range. If the command :BB:MCCW:EDIT:CARR:PHAS:STEP is used to define a step width, the phase entered here applies only to the starting carrier. The phases of the remaining carriers are stepped up or down by the phase value specified in the :BB:MCCW:EDIT:CARR:PHAS:STEP command.

The phase settings are only valid if optimization of the crest factor is disabled (:SOURce:BB:MCCW:CFACTOR:MODE OFF).

**Example:** "BB:MCCW:EDIT:CARR:PHAS 90 DEG"  
 'sets a start phase of 90° for the carriers in the carrier range.

RST value	Resolution	Options	SCPI
0 DEG	0.01 DEG	B10/B11 and B13 K61 SOURce2 only with second option B9/B10/B11	Device-specific

**[SOURce<[1]|2>:]BB:MCCW:EDIT:CARRIER:PHAS:STEP 0 ... 360 DEG.**

The command sets the step width by which the start phases of the carriers in the defined carrier range will be incremented.

The phase settings are only valid if optimization of the crest factor is disabled (:SOURce:BB:MCCW:CFACTOR:MODE OFF).

**Example:** "BB:MCCW:EDIT:CARR:PHAS 90 DEG"  
'sets a start phase of 90° for the carriers in the carrier range.

"BB:MCCW:EDIT:CARR:PHAS:STEP 1 DEG"  
'the start phase is incremented by 1° for each carrier, i.e. the first carrier has a start phase of 90°, the second a start phase of 91°, etc.

*RST value	Resolution	Options	SCPI
0 DEG	0.01 DEG	B10/B11 and B13 K61 SOURce2 only with second option B9/B10/B11	Device-specific

**[SOURce<[1]|2>:]BB:MCCW:EDIT:CARRIER:POWer[:START] 80 dB ... 0 dB**

The command sets the power for the individual carriers in the defined carrier range. If the command :BB:MCCW:EDIT:CARR:POW:STEP is used to define a step width, the power entered here applies only to the starting carrier. The power of the remaining carriers is stepped up or down by the power specified in the :BB:MCCW:EDIT:CARR:POW:STEP command.

**Example:** "BB:MCCW:EDIT:CARR:POW -50 dB"  
'sets the power of the carrier to -50 dB.

*RST value	Resolution	Options	SCPI
0 dB	0.01 dB	B10/B11 and B13 K61 SOURce2 only with second option B9/B10/B11	Device-specific

**[SOURce<[1]|2>:]BB:MCCW:EDIT:CARRIER:POWer:STEP - 80 dB ... +80 dB.**

The command sets the step width by which the starting power of the carriers in the defined carrier range will be incremented.

**Example:** "BB:MCCW:EDIT:CARR:POW -80dB"  
'sets a power of -80 dB for the carriers in the carrier range.

"BB:MCCW:EDIT:CARR:POW:STEP 1 dB"  
'the power phase is incremented by 1dB for each carrier, i.e. the first carrier has -80dB, the second -79dB, etc.

*RST value	Resolution	Options	SCPI
0 dB	0.01 dB	B10/B11 and B13 K61 SOURce2 only with second option B9/B10/B11	Device-specific

**[SOURce<[1]|2>:]BB:MCCW:EDIT:CARRier:STARt <carrier\_index>**

The command selects the first carrier in the carrier range to which the settings with the :BB:MCCW:EDIT:CARR: . . commands shall apply.

**Example:** "BB:MCCW:EDIT:CARR:STAR 4"  
'the carrier range starts at carrier 4.

*RST value	Resolution	Options	SCPI
0		B10/B11 and B13 K61 SOURce2 only with second option B9/B10/B11	Device-specific

**[SOURce<[1]|2>:]BB:MCCW:EDIT:CARRier:STATe ON | OFF**

The command switches all the carriers in the selected carrier range on or off.

**Example:** "BB:MCCW:EDIT:CARR:STAT ON"  
'sets all the carriers in the carrier range to ON.

*RST value	Resolution	Options	SCPI
OFF	-	B10/B11 and B13 K61 SOURce2 only with second option B9/B10/B11	Device-specific

**[SOURce<[1]|2>:]BB:MCCW:EDIT:CARRier:STOP <carrier\_index>**

The command selects the last carrier in the carrier range to which the settings with the :BB:MCCW:EDIT:CARR: . . commands shall apply.

**Example:** "BB:MCCW:EDIT:CARR:STOP 40"  
'the carrier range stops at carrier 40.

*RST value	Resolution	Options	SCPI
0		B10/B11 and B13 K61 SOURce2 only with second option B9/B10/B11	Device-specific



[SOURce<[1]|2>:]BB:MCCW:PRESet

The command sets all multicarrier signal parameters to their default values

This command triggers an event and therefore has no \*RST value and no query form.

**Example:** "BB:MCCW:PRESet"  
 'resets the Multicarrier settings to default values.

*RST value	Options	Dependencies	SCPI
-	B10/B11 and B13 K61 SOURce2 only with second option B9/B10/B11	:BB:MCCW:CARR:COUN 64 :BB:MCCW:CARR:PHAS 0 :BB:MCCW:CARR:POW 0 :BB:MCCW:CARR:SPAC 10 kHz :BB:MCCW:CARR:STAT ON :BB:MCCW:CLOC:SOUR INT :BB:MCCW:CFAC 3 dB :BB:MCCW:CFAC:MODE FAST :BB:MCCW:STAT OFF :BB:MCCW:TRIG:EXT:DEL 0 :BB:MCCW:TRIG:EXT:INH 0 :BB:MCCW:TRIG:OBAS:DEL 0 :BB:MCCW:TRIG:OBAS:INH 0 :BB:MCCW:TRIG:OUTP<[1] 2 3 4>:MODE REST :BB:MCCW:TRIG:OUTP<[1] 2 3 4>:PFR 1MHz :BB:MCCW:TRIG:OUTP<[1] 2 3 4>:PATT #H0,1 :BB:MCCW:TRIG:OUTP<[1] 2 3 4>:OFFT 0 :BB:MCCW:TRIG:OUTP<[1] 2 3 4>:ONT 0 :BB:MCCW:TRIG:SEQ AUTO :BB:MCCW:TRIG:SOUR INT	Device-specific

[SOURce<[1]|2>:]BB:MCCW:SEQuence AUTO | RETRigger | AAUTo | ARETrigger | SINGle

The command selects the trigger mode.

**Parameter:**       **AUTO**  
                           The multicarrier signal is generated continuously.

**RETRigger**  
                           The multicarrier signal is generated continuously. A trigger event (internal or external) causes a restart.

**AAUTo**  
                           The multicarrier signal is generated only when a trigger event occurs. After the trigger event the signal is generated continuously. Signal generation is stopped with command `SOUR:BB:MCCW:TRIG:ARM:EXEC` and started again when a trigger event occurs.

**ARETrigger**  
                           The multicarrier signal is generated only when a trigger event occurs. The device automatically toggles to RETRIG mode. Every subsequent trigger event causes a restart. Signal generation is stopped with command `SOUR:BB:MCCW:TRIG:ARM:EXEC` and started again when a trigger event occurs.

**SINGle**  
                           The multicarrier signal is output only when a trigger event occurs. After the trigger event the signal is output once to the set sequence length (`SOUR:BB:MCCW:TRIG:SLEN`). Every subsequent trigger event causes a restart.

**Example:**           `"BB:MCCW:SEQ AAUT"`  
                           'sets the **Armed\_auto** trigger mode; the device waits for the first trigger (e.g. with `*TRG`) and then generates the signal continuously.

*RST value	Resolution	Options	SCPI
RETRigger	-	B10/B11 and B13 K61 SOURce2 only with second option B9/B10/B11	Device-specific

[SOURce<[1]|2>:]BB:MCCW:STATe ON | OFF

The command turns on the Multicarrier CW signal. Any other digital standards or digital modulation that may be in the ON state will be automatically turned OFF.

**Example:**           `"BB:MCCW:STAT ON"`  
                           'switches on generation of the Multicarrier CW signal.

*RST value	Resolution	Options	Dependencies	SCPI
OFF	-	B10/B11 and B13 K61 SOURce2 only with second option B9/B10/B11	:BB:MCCW:STAT ON switches off all the digital standards and digital modulation on the same path.	Device-specific

[SOURce<[1]|2>:]BB:MCCW:TRIGger:ARM:EXECute

The command stops signal generation for trigger modes Armed\_Auto and Armed\_Retrigger. A subsequent internal or external trigger event restart signal generation.

This command triggers an event and therefore has no \*RST value and no query form.

**Example:** "BB:MCCW:TRIG:SOUR INT"  
 'sets internal triggering.

"BB:MCCW:TRIG:SEQ ARET"  
 'sets Armed\_Retrigger mode, i.e. every trigger event causes signal generation to restart.

"BB:MCCW:TRIG:EXEC"  
 'executes a trigger, signal generation is started.

"BB:MCCW:TRIG:ARM:EXEC"  
 'signal generation is stopped.

"BB:MCCW:TRIG:EXEC"  
 'executes a trigger, signal generation is started again.

*RST value	Resolution	Options	SCPI
-	-	B10/B11 and B13 K61 SOURce2 only with second option B9/B10/B11	Device-specific

[SOURce<[1]|2>:]BB:MCCW:TRIGger:EXECute

The command executes a trigger. The internal trigger source must be selected using the command MCCW:TRIGger:SOURce INTernal and a trigger mode other than AUTO must be selected using the command :BB:MCCW:TRIGger:MODE.

This command triggers an event and therefore has no \*RST value and no query form.

**Example:** "BB:MCCW:TRIG:SOUR INT"  
 'sets internal triggering.

"BB:MCCW:TRIG:SEQ RETR"  
 'sets Retrigger mode, i.e. every trigger event causes signal generation to restart.

"BB:MCCW:TRIG:EXEC"  
 'executes a trigger.

*RST value	Resolution	Options	SCPI
-	-	B10/B11 and B13 K61 SOURce2 only with second option B9/B10/B11	Device-specific

**[SOURce<[1]|2>:]BB:MCCW:TRIGger[:EXtErnal<[1]|2>]:DELay 0 ... 2<sup>32</sup>-1 samples**

The command specifies the trigger delay (expressed as a number of samples) for external triggering. The numeric suffix to EXtErnal distinguishes between the external trigger via the TRIGGER 1 (suffix 1) and TRIGGER 2 (suffix 2) connector.

**Example:** "BB:MCCW:TRIG:SOUR EXT"  
 'selects an external trigger via the TRIGGER 1 connector.  
 "BB:MCCW:TRIG:DEL 200"  
 'sets a delay of 200 samples for the trigger.

*RST value	Resolution	Options	SCPI
0	1	B10/B11 and B13 K61 SOURce2 only with second option B9/B10/B11	Device-specific

**[SOURce<[1]|2>:]BB:MCCW:TRIGger[:EXtErnal<[1]|2>]:INHibit 0 ... 2<sup>26</sup>-1 samples**

The command specifies the number of samples by which a restart is to be inhibited following a trigger event. This command applies only in the case of external triggering. The numeric suffix to EXtErnal distinguishes between the external trigger via the TRIGGER 1 (suffix 1) and TRIGGER 2 (suffix 2) connector.

**Example:** "BB:MCCW:TRIG:SOUR EXT"  
 'selects an external trigger via the TRIGGER 1 connector.  
 "BB:MCCW:TRIG:INH 200"  
 'sets a restart inhibit for 200 samples following a trigger event.

*RST value	Resolution	Options	SCPI
0	1	B10/B11 and B13 K61 SOURce2 only with second option B9/B10/B11	Device-specific

**[SOURce<[1]|2>:]BB:MCCW:TRIGger:OBASeband:DELay 0 ... 2<sup>32</sup>-1 samples**

The command specifies the trigger delay (expressed as a number of samples) for triggering by the signal from the second path (two-path instruments only).

**Example:** "BB:MCCW:TRIG:SOUR OBAS"  
 'sets for path A the internal trigger executed by the signal from the second path (path B).  
 "BB:MCCW:TRIG:DEL 200"  
 'sets a delay of 200 samples for the trigger.

*RST value	Resolution	Options	SCPI
0	1	B10/B11 and B13 K61 SOURce2 only with second option B9/B10/B11	Device-specific

**[SOURce<[1]>:]BB:MCCW:TRIGger:OBASband:INHibit 0 ... 2<sup>32</sup>-1 samples**

The command specifies the number of samples by which a restart is to be inhibited following a trigger event. This command applies only for triggering by the second path (two-path instruments only).

**Example:** "BB:MCCW:TRIG:SOUR OBAS"  
'sets for path A the internal trigger executed by the signal from the second path (path B).

"BB:MCCW:TRIG:INH 200"  
'sets a restart inhibit for 200 samples following a trigger event.

*RST value	Resolution	Options	SCPI
0	1	B10/B11 and B13 K61 SOURce2 only with second option B9/B10/B11	Device-specific

**[SOURce<[1]>:]BB:MCCW:TRIGger:OUTPut<[1]...4>:DELay 0 ... 2<sup>20</sup>-1 Symbols**

The command defines the delay between the signal on the marker outputs and the start of the signals, expressed in terms of samples. Command :BB:MCCW:TRIGger:OUTPut:DELay:FIXed ON can be used to restrict the range of values to the dynamic range, i.e. the range within which a delay of the marker signals can be set without restarting the marker and signal.

**Example:** "BB:MCCW:TRIG:OUTP2:DEL 16"  
'sets a delay of 16 samples for the signal on connector MARKER 2.

*RST value	Resolution	Options	SCPI
0 Symbols	1	B10/B11 and B13 K61 SOURce2 only with second option B9/B10/B11	Device-specific

**[SOURce<[1]>:]BB:MCCW:TRIGger:OUTPut:DELay:FIXed ON | OFF**

The command restricts the marker delay setting range to the dynamic range. In this range the delay can be set without restarting the marker and signal. If a delay is entered in setting ON but is outside this range, the maximum possible delay is set and an error message is generated.

The numeric suffix in OUTPut has no significance for this command, since the setting always affects every marker.

**Example:** "BB:MCCW:TRIG:OUTP:DEL:FIX ON"  
'restricts the marker signal delay setting range to the dynamic range.

*RST value	Resolution	Options	SCPI
OFF	-	B10/B11 and B13 K61 SOURce2 only with second option B9/B10/B11	Device-specific

**[SOURce<[1]2>:]BB:MCCW:TRIGger:OUTPut<[1]...4>:DELay:MAXimum**

The command queries the maximum marker delay for setting :BB:MCCW:TRIGger:OUTPut:DELay:FIXed ON.

The command is a query only and therefore has no \*RST value.

**Example:** "BB:MCCW:TRIG:OUTP:DEL:FIX ON"  
'restricts the marker signal delay setting range to the dynamic range.

"BB:MCCW:TRIG:OUTP:DEL:MAX"  
'queries the maximum of the dynamic range.

Response: "2000"  
'the maximum for the marker delay setting is 2000 samples.

*RST value	Resolution	Options	SCPI
-	-	B10/B11 and B13 K61 SOURce2 only with second option B9/B10/B11	Device-specific

**[SOURce<[1]2>:]BB:MCCW:TRIGger:OUTPut<[1]...4>:DELay:MINimum**

The command queries the minimum marker delay for setting :BB:MCCW:TRIGger:OUTPut:DELay:FIXed ON..

The command is a query only and therefore has no \*RST value.

**Example:** "BB:MCCW:TRIG:OUTP:DEL:FIX ON"  
'restricts the marker signal delay setting range to the dynamic range.

"BB:MCCW:TRIG:OUTP:DEL:MIN"  
'queries the minimum of the dynamic range.

Response: "0"  
'the minimum for the marker delay setting is 0 samples.

*RST value	Resolution	Options	SCPI
-	-	B10/B11 and B13 K61 SOURce2 only with second option B9/B10/B11	Device-specific

**[SOURce<[1]|2>:]BB:MCCW:TRIGger:OUTPut<[1]...4>:MODE REStart | PULSe | PATtern | RATio**

The command defines the signal for the selected marker output.

**Parameter: REStart**

A marker signal is generated at every signal start.

**PULSe**

A pulsed marker signal is generated. The pulse frequency (= symbol rate/divider) is defined with the SOUR:BB:MCCW:TRIG:OUTP:PULS:DIVider command and can be queried with the SOUR:BB:MCCW:TRIG:OUTP:PULS:FREQ? command.

**PATtern**

A marker signal is generated with the aid of a user-definable bit pattern. The bit pattern is entered with the aid of command SOURce:BB:MCCW:TRIGger:PATtern. The bit pattern is a maximum of 32 bits long.

**RATio**

A regular marker signal corresponding to the Time Off / Time On specifications in the commands SOURce:BB:MCCW:TRIGger:OFFT and SOURce:BB:MCCW:TRIGger:ONT is generated.

**Example:** "BB:MCCW:TRIG:OUTP2:MODE PULS"  
'selects the pulsed marker signal on output MARKER 2.

*RST value	Resolution	Options	SCPI
REStart	-	B10/B11 and B13 K61 SOURce2 only with second option B9/B10/B11	Device-specific

**[SOURce<[1]|2>:]BB:MCCW:TRIGger:OUTPut<[1]...4>:OFFTime 1 ... max. wave length -1 sample**

The command sets the number of samples in a period (ON time + OFF time) during which the marker signal in setting SOURce:BB:MCCW:TRIGger:OUTPut:MODE RATio on the marker outputs is OFF.

**Example:** "BB:MCCW:TRIG:OUTP2:OFFT 20"  
'sets an OFF time of 20 samples for marker signal 2 on path A.

*RST value	Resolution	Options	SCPI
1 Sample	1	B10/B11 and B13 K61 SOURce2 only with second option B9/B10/B11	Device-specific

**[SOURce<[1]|2>:]BB:MCCW:TRIGger:OUTPut<[1]...4>:ONTime 1 ... max. wavelength -1 sample**

The command sets the number of samples in a period (ON time + OFF time) during which the marker signal in setting SOURce:BB:MCCW:TRIGger:OUTPut:MODE RATIO on the marker outputs is ON.

**Example:** "BB:MCCW:TRIG:OUTP2:ONT 20"  
'sets an ON time of 20 samples for marker 2 on path A.

*RST value	Resolution	Options	SCPI
1 Sample	1	B10/B11 and B13 K61 SOURce2 only with second option B9/B10/B11	Device-specific

**[SOURce<[1]|2>:]BB:MCCW:TRIGger:OUTPut<[1]...4>:PATTern #B0,1 ... #B111...1,32**

The command defines the bit pattern used to generate the marker signal in the setting SOURce:BB:MCCW:TRIGger:OUTPut:MODE PATTern 0 is marker off, 1 is marker on.

**Example:** "BB:MCCW:TRIG:OUTP2:PATT #HE0F52,20"  
'sets a bit pattern.  
"BB:MCCW:TRIG:OUTP2:MODE PATT"  
'activates the marker signal according to a bit pattern on output MARKER 2.

*RST value	Resolution	Options	SCPI
0		B10/B11 and B13 K61 SOURce2 only with second option B9/B10/B11	Device-specific

**[SOURce<[1]|2>:]BB:MCCW:TRIGger:OUTPut<[1]...4>:PULSe:DIVider 2 ... 2^10**

The command sets the divider for Pulse marker mode (SOUR:BB:MCCW:TRIG:OUTP:MODE PULSe). The resulting pulse frequency is derived by dividing the symbol rate by the divider.

**Example:** "BB:MCCW:TRIG:OUTP2:PULS:DIV 2"  
'sets the divider for the path A marker signal on output MARKER 2 to the value 2.  
"BB:MCCW:TRIG:OUTP2:FREQ?"  
'queries the resulting pulse frequency of the marker signal.  
Response: "66 000"  
'the resulting pulse frequency is 66 kHz.

*RST value	Resolution	Options	SCPI
2	1	B10/B11 and B13 K61 SOURce2 only with second option B9/B10/B11	Device-specific



**[SOURce<[1]|2>:]BB:MCCW:TRIGger:OUTPut<[1]...4>:PULSe:FREQuency?**

The command queries the pulse frequency of the pulsed marker signal in the setting SOUR:BB:MCCW:TRIG:OUTP:MODE PULS. The pulse frequency is derived by dividing the symbol rate by the divider. The divider is defined with command SOUR:BB:MCCW:TRIG:OUTP:PULS:DIV.

The command is a query only and therefore has no \*RST value.

**Example:** "BB:MCCW:TRIG:OUTP2:PULS:DIV 4"  
'sets the divider for the path A marker signal on output MARKER 2 to the value 4.

"BB:MCCW:TRIG:OUTP2:MODE PULS"  
'enables the pulsed marker signal.

"BB:MCCW:TRIG:OUTP2:PULS:FREQ?"  
'queries the pulse frequency for the marker signal.

Response: "33 000"  
'the resulting pulse frequency is 33 kHz.

*RST value	Resolution	Options	SCPI
-	-	B10/B11 and B13 K61 SOURce2 only with second option B9/B10/B11	Device-specific

**[SOURce<[1]|2>:]BB:MCCW:TRIGger:RMODE**

The command queries the current status of signal generation for all trigger modes with Multicarrier CW on.

The command is a query command and therefore has no \*RST value.

**Parameter:** **RUN**  
the signal is generated. A trigger event occurred in the triggered mode.

**STOP**  
the signal is not generated. A trigger event did not occur in the triggered modes, or signal generation was stopped by the command  
:BB:MCCW:TRIG:ARM:EXECute (armed trigger modes only).

**Example:** "SOUR2:BB:MCCW:TRIG:SOUR EXT"  
'sets external triggering via the TRIGGER 1 connector for path B of a two-path instrument.

"SOUR2:BB:MCCW:TRIG:MODE ARET"  
'selects the Armed\_Retrigger mode.

"SOUR2:BB:MCCW:TRIG:RMODE?"  
'queries the current status of signal generation.

Response: "RUN"  
'the signal is generated, an external trigger was executed.

*RST value	Resolution	Options	SCPI
-	-	B10/B11 and B13 K61 SOURce2 only with second option B9/B10/B11	Device-specific

[SOURce<[1]|2>:]BB:MCCW:TRIGger:SLENgth 1 ... (2^32-1) Samples

The command defines the length of the signal sequence to be output in the **Single** trigger mode. The input is to be expressed in samples. It is then possible to output deliberately just part of the waveform, an exact sequence of the waveform, or a defined number of repetitions of the waveform.

**Example:** "SOUR2:BB:MCCW:SEQ SING"  
'sets trigger mode Single.

"SOUR2:BB:MCCW:TRIG:SLEN 200"  
'sets a sequence length of 200 samples. The first 200 samples of the current waveform will be output after the next trigger event.

*RST value	Resolution	Options	SCPI
1 Waveform length	-	B10/B11 and B13 K61 SOURce2 only with second option B9/B10/B11	Device-specific

[SOURce<[1]|2>:]BB:MCCW:TRIGger:SOURce INTernal | EXTernal | BEXTernal | OBASeband

The command selects the trigger source.

**Parameter: INTernal**  
Triggering is executed by means of the Trigger command :BB:MCCW:TRIG:EXECute in the case of remote control, and by means of **Execute Trigger** in the case of manual operation.

**EXTernal**  
Triggering is executed by means of the signal on the TRIGGER 1 connector.

**BEXTernal**  
Triggering is executed by means of the signal on the TRIGGER 2 connector.

**OBASeband**  
Triggering is executed by means of the signal from the second path (two-path instruments only).

**Example:** "BB:MCCW:TRIG:SOUR INT"  
'sets internal triggering.

*RST value	Resolution	Options	SCPI
INTernal	-	B10/B11 and B13 K61 SOURce2 only with second option B9/B10/B11	Device-specific

## SOURce:BB:POWer Subsystem

This subsystem contains the commands for retrieving the level values of the digital baseband signal.

The numeric suffix to SOURce distinguishes between the signal for path A and path B in the case of two-path instruments:

SOURce[1] = Path A

SOURce2 = path B

The keyword SOURce is optional in the case of commands for path A and can be omitted. For path B the command must contain the keyword with suffix 2.

The keyword SOURce is optional and can be omitted.

Command	Parameters	Default unit	Remark
[SOURce<[1] 2>:]BB:CFACtor		dB	Query only
[SOURce<[1] 2>:]BB:POWer:PEAK		dBfs	Query only
[SOURce<[1] 2>:]BB:POWer:RMS		dBfs	Query only

### [SOURce<[1]|2>:]BB:CFACtor?

This command queries the crest factor of the baseband signal .

The command is a query command and therefore has no \*RST value.

**Example:** "BB:CFAC?"  
'queries the crest factor of the baseband signal.

*RST value	Resolution	Options	SCPI
-	-	B13 and B10/B11 SOURce2 only with second B13 option	Device-specific

### [SOURce<[1]|2>:]BB:POWer:PEAK?

This command queries the peak level of the baseband signal relative to full scale of 0.5 V (in terms of dB full scale).

The command is a query command and therefore has no \*RST value.

**Example:** "BB:POW:PEAK?"  
'queries the peak level of the baseband signal.

*RST value	Resolution	Options	SCPI
-	-	B13 and B10/B11 SOURce2 only with second B13 option	Device-specific

**[SOURce<[1]|2>:]BB:POWer:RMS?**

This command queries the rms level of the baseband signal relative to full scale of 0.5 V (in terms of dB full scale).

The command is a query command and therefore has no \*RST value.

**Example:**           "BB:POW:RMS?"  
                          'queries the rms level of the baseband signal.

*RST value	Resolution	Options	SCPI
-	-	B13 and B10/B11 SOURce2 only with second B13 option	Device-specific

## SOURce:BB:TDSCdma-Subsystem

The commands in the SOURce:BB:TDSCdma subsystem are described in three sections, separated into general remote commands, commands for cell settings and commands for slot settings.

This subsystem contains commands for the primary and general settings of the TD-SCDMA standard. These settings concern activation and deactivation of the standard, setting the transmission direction, filter, clock, trigger and clipping settings, defining the chip rate and the sequence length, as well as the preset and power adjust setting.

The commands for setting the cells and the slots are described in separate sections. The commands are divided up in this way to make the extremely comprehensive SOURce:BB:TDSCdma subsystem clearer.

The numerical suffix at SOURce distinguishes between path A and path B for two-path instruments:

SOURce<1> = path A

SOURce<2> = path B

The keyword SOURce is optional with commands for path A and can be omitted. For path B, the command must include the keyword with the suffix 2.

Command	Parameter	Default Unit	Comments
[SOURce<[1] 2>:]BB:TDSCdma:CLIPping:LEVel	1...100	PCT	
[SOURce<[1] 2>:]BB:TDSCdma:CLIPping:MODE	VECTor   SCALar		
[SOURce<[1] 2>:]BB:TDSCdma:CLIPping:STATe	ON   OFF		
[SOURce<[1] 2>:]BB:TDSCdma:CLOCK:MODE	CHIP   MCHip		
[SOURce<[1] 2>:]BB:TDSCdma:CLOCK:MULTIplier	1... 64		
[SOURce<[1] 2>:]BB:TDSCdma:CLOCK:SOURce	EXTernal   INTernal		
[SOURce<[1] 2>:]BB:TDSCdma:COPY:DESTination	1...4		
[SOURce<[1] 2>:]BB:TDSCdma:COPY:EXECute	-		
[SOURce<[1] 2>:]BB:TDSCdma:COPY:SOURce	1...4		
[SOURce<[1] 2>:]BB:TDSCdma:CRATe?			Query only
[SOURce<[1] 2>:]BB:TDSCdma:CRATe:VARiation	1 MHz ... 5 MHz	Hz (c/s)	
[SOURce<[1] 2>:]BB:TDSCdma:FILTer:PARAmeter:APCO25	0.15 ... 2.5		
[SOURce<[1] 2>:]BB:TDSCdma:FILTer:PARAmeter:COSine	0.05 ... 0.99		
[SOURce<[1] 2>:]BB:TDSCdma:FILTer:PARAmeter:GAUSS	0.15 ... 2.50		
[SOURce<[1] 2>:]BB:TDSCdma:FILTer:PARAmeter:PGAus	0.15 ... 2.5		
[SOURce<[1] 2>:]BB:TDSCdma:FILTer:PARAmeter:RCOSine	0.05 ... 0.99		
[SOURce<[1] 2>:]BB:TDSCdma:FILTer:PARAmeter:SPHase	0.15 ... 2.5		
[SOURce<[1] 2>:]BB:TDSCdma:FILTer:TYPE	RCOSine   COSine   GAUSS   LGAuss   PGAuss   CONE   COF705   COEQualizer   COFequalizer   C2K3x   APCO25   SPHase   RECTangle		
[SOURce<[1] 2>:]BB:TDSCdma:LINK	FORWard   REVERSE (Alias DOWN   UP)		
[SOURce<[1] 2>:]BB:TDSCdma:POWER:ADJust	-		No query

Command	Parameter	Default Unit	Comments
[SOURce<[1]2>:]BB:TDSCdma:POWer[:TOTal]?			Query only
[SOURce<[1]2>:]BB:TDSCdma:PRAMp:BBONly	OFF   ON		
[SOURce<[1]2>:]BB:TDSCdma:PRAMp:FDELay	-9.0...9.0		
[SOURce<[1]2>:]BB:TDSCdma:PRAMp:RDELay	-9.0...9.0		
[SOURce<[1]2>:]BB:TDSCdma:PRAMp:SHAPE	LINear   COSine		
[SOURce<[1]2>:]BB:TDSCdma:PRAMp:TIME	0.3...16.0		
[SOURce<[1]2>:]BB:TDSCdma:PRESet			No query
[SOURce<[1]2>:]BB:TDSCdma:RESet			No query
[SOURce<[1]2>:]BB:TDSCdma:SEQuence	AUTO   RETRigger   AAUTO   ARETRigger   SINGLE		
[SOURce<[1]2>:]BB:TDSCdma:SETTing:CATalog?			Query only
[SOURce<[1]2>:]BB:TDSCdma:SETTing:DELeTe	<file_name>		
[SOURce<[1]2>:]BB:TDSCdma:SETTing:LOAD	<file_name>		
[SOURce<[1]2>:]BB:TDSCdma:SETTing:STORe	<file_name>		
[SOURce<[1]2>:]BB:TDSCdma:SLENgth	1 ... 511 frames		
[SOURce<[1]2>:]BB:TDSCdma:STATe	ON   OFF		
[SOURce<[1]2>:]BB:TDSCdma:TRIGger:ARM:EXECute			No query
[SOURce<[1]2>:]BB:TDSCdma:TRIGger:EXECute			No query
[SOURce<[1]2>:]BB:TDSCdma:TRIGger[:EXTernal<[1]2>]:DELay	0 ...65 535 chips		
[SOURce<[1]2>:]BB:TDSCdma:TRIGger[:EXTernal<[1]2>]:INHibit	0 ... (2 <sup>26</sup> - 1) chips		
[SOURce<[1]2>:]BB:TDSCdma:TRIGger:OBASeband:DELay	0 ...65 535 chips		
[SOURce<[1]2>:]BB:TDSCdma:TRIGger:OBASeband:INHibit	0 ... (2 <sup>26</sup> - 1) chips		
[SOURce<[1]2>:]BB:TDSCdma:TRIGger:OUTPut<[1]...4>:DELay	0 ... (2 <sup>24</sup> - 1) chips		
[SOURce<[1]2>:]BB:TDSCdma:TRIGger:OUTPut:DELay:FIXed	ON   OFF		
[SOURce<[1]2>:]BB:TDSCdma:TRIGger:OUTPut<[1]...4>:DELay:MAXImum?			Query only
[SOURce<[1]2>:]BB:TDSCdma:TRIGger:OUTPut<[1]...4>:DELay:MINImum?			Query only
[SOURce<[1]2>:]BB:TDSCdma:TRIGger:OUTPut<[1]...4>:MODE	RFRame   SFNR   CSPeriod   USER   RATio		
[SOURce<[1]2>:]BB:TDSCdma:TRIGger:OUTPut<[1]...4>:OFFTime	0 ... (2 <sup>24</sup> - 1) chips		
[SOURce<[1]2>:]BB:TDSCdma:TRIGger:OUTPut<[1]...4>:ONTTime	0 ... (2 <sup>24</sup> - 1) chips		
[SOURce<[1]2>:]BB:TDSCdma:TRIGger:OUTPut<[1]...4>:PERiod	2 ... (2 <sup>32</sup> - 1) chips		
[SOURce<[1]2>:]BB:TDSCdma:TRIGger:RMODE			Query only
[SOURce<[1]2>:]BB:TDSCdma:TRIGger:SLENgth	0 ... (2 <sup>32</sup> - 1) chips		
[SOURce<[1]2>:]BB:TDSCdma:TRIGger:SLUNit	FRAMe   CHIP   SEQuence		
[SOURce<[1]2>:]BB:TDSCdma:TRIGger:SOURce	EXTernal   INTernal   BEXTernal   OBASeband		
[SOURce<[1]2>:]BB:TDSCdma:VERSion?			Query only
[SOURce<[1]2>:]BB:TDSCdma:WAVeform:CREate			No query

## SOURce:TDSCdma - Primary Commands

### [SOURce<[1]|2>:]BB:TDSCdma:CLIPping:LEVel 1 ... 100 PCT

The command sets the limit for level clipping (Clipping). This value indicates at what point the signal is clipped. It is specified as a percentage, relative to the highest level. 100% indicates that clipping does not take place.

**Example:** "BB:TDSC:CLIP:LEV 80"  
'sets the limit for level clipping to 80% of the maximum level.

"BB:TDSC:CLIP:STAT ON"  
'activates level clipping.

*RST value	Resolution	Options	SCPI
100 PCT	1	B10/B11 and B13 K50 SOURce2 only with second option B9/B10/B11	Device-specific

### [SOURce<[1]|2>:]BB:TDSCdma:CLIPping:MODE VECTor | SCALar

The command sets the method for level clipping (Clipping).

**Parameters:** **VECTor**  
The reference level is the amplitude  $|i+jq|$ .

**SCALar**  
The reference level is the absolute maximum of the I and Q values.

**Example:** "BB:TDSC:CLIP:MODE VECT"  
'sets the amplitude as reference level.

*RST value	Resolution	Options	SCPI
VECTor	-	B10/B11 and B13 K50 SOURce2 only with second option B9/B10/B11	Device-specific

### [SOURce<[1]|2>:]BB:TDSCdma:CLIPping:STATe ON | OFF

The command activates level clipping (Clipping). The value is defined with the command [SOURce<[1]|2>:]BB:TDSCdma:CLIPping:LEVel, the mode of calculation with the command [SOURce<[1]|2>:]BB:TDSCdma:CLIPping:MODE.

**Example:** "BB:TDSC:CLIP:STAT ON"  
'activates level clipping.

*RST value	Resolution	Options	SCPI
OFF		B10/B11 and B13 K50 SOURce2 only with second option B9/B10/B11	Device-specific

[SOURce<[1]]2>:]BB:TDSCdma:CLOCK:MODE CHIP | MCHip

The command enters the type of externally supplied clock (BB:TDSCdma:CLOCK:SOURce EXTERNAL). When MCHip is used, a multiple of the chip clock is supplied via the CLOCK connector and the chip clock is derived internally from this. The multiplier is entered with the command :BB:TDSCdma:CLOCK:MULTIPLIER.

With this command the only numerical suffix allowed for SOURce is 1, since the external clock source is permanently allocated to path A.

**Example:** "BB:TDSC:CLOC:MODE MCH"  
'sets the type of externally supplied clock.

*RST value	Resolution	Options	SCPI
CHIP	-	B10/B11 and B13 K50	Device-specific

[SOURce<[1]]2>:]BB:TDSCdma:CLOCK:MULTIPLIER 1 ... 64

The command specifies the multiplier for clock type **Multiplied** (:BB:TDSCdma:CLOCK:MODE MCHip) in the case of an external clock source.

With this command the only numerical suffix allowed for SOURce is 1, since the external clock source is permanently allocated to path A.

**Example:** "BB:TDSC:CLOC:SOUR EXT"  
'selects the external clock source. The clock is supplied via the CLOCK connector.

"BB:TDSC:CLOC:MODE MCH"  
'selects clock type **Multiplied**, i.e. the supplied clock has a rate which is a multiple of the chip rate.

"BB:TDSC:CLOC:MULT 12"  
'the multiplier for the external clock rate is 12.

*RST value	Resolution	Options	SCPI
4	1	B10/B11 and B13 K50	Device-specific



[SOURce<[1]|2>:]BB:TDSCdma:CLOCK:SOURce INTernal | EXTernal

The command selects the clock source.

Selecting EXTernal is only possible for path A, since the external clock source is permanently allocated to path A.

**Parameters:**     **INTernal**

The internal clock reference is used.

**EXTernal**

The external clock reference is supplied to the CLOCK connector. Commands :BB:TDSC:CLOCK:MODE and :MULTIplier are used to enter the type of the external clock.

**Example:**

"BB:TDSC:CLOC:SOUR EXT"

'selects the external clock source. The clock is supplied via the CLOCK connector.

"BB:TDSC:CLOC:MODE MCH"

'selects clock type **Multiplied**, i.e. the supplied clock has a rate which is a multiple of the chip rate.

"BB:TDSC:CLOC:MULT 12"

'the multiplier for the external clock rate is 12.

*RST value	Resolution	Options	SCPI
INTernal	-	B10/B11 and B13 K50 SOURce2 only with second option B10/11	Device-specific

[SOURce<[1]|2>:]BB:TDSCdma:COPY:DESTination 1 ...4

The command selects the cell whose settings are to be overwritten.

**Example:**

"BB:TDSC:LINK DOWN"

'selects the downlink/forward transmit direction (base station to mobile station)

"BB:TDSC:COPY:SOUR 1"

'selects cell 1 as the source.

"BB:TDSC:COPY:DEST 4"

'selects cell 4 as the destination.

"BB:TDSC:COPY:EXEC"

'starts copying the parameter set of cell 1 to cell 4.

*RST value	Resolution	Options	SCPI
2	-	B10/B11 and B13 K50 SOURce2 only with second option B10/11	Device-specific

[SOURce<[1]|2>:]BB:TDSCdma:COPY:EXECute

The command starts the copy process. The dataset of the selected source cell is copied to the destination cell .

This command triggers an event and therefore has no \*RST value and no query form.

**Example:** "BB:TDSC:COPY:EXEC"  
 'starts copying the parameter set of the selected source cell to the selected destination cell.

*RST value	Resolution	Options	SCPI
-	-	B10/B11 and B13 K50 SOURce2 only with second option B10/11	Device-specific

[SOURce<[1]|2>:]BB:TDSCdma:COPY:SOURce 1 ...4

The command selects the cell whose settings are to be copied.

**Example:** "BB:TDSC:LINK UP"  
 'selects the uplink transmit direction (mobile station to base station)  
 "BB:TDSC:COPY:SOUR 1"  
 'selects cell 1 as the source.  
 "BB:TDSC:COPY:DEST 4"  
 'selects cell 4 as the destination.  
 "BB:TDSC:COPY:EXEC"  
 'starts copying the parameter set of cell 1 to cell 4.

*RST value	Resolution	Options	SCPI
1	-	B10/B11 and B13 K50 SOURce2 only with second option B10/11	Device-specific

[SOURce<[1]|2>:]BB:TDSCdma:CRATe?

The command queries the system chip rate. The output chip rate which determines the rate of the spread symbols as is used for signal output can be set with the command

SOUR:BB:TDSC:CRAT:VAR.

The command is a query command and therefore does not have an \*RST value.

**Example:** "BB:TDSC:CRAT?"  
 'queries the system chip rate.

Response: "R1M2"  
 'the system chip rate is 1.2288 Mcps.

*RST value	Resolution	Options	SCPI
-	-	B10/B11 and B13 K50 SOURce2 only with second option B10/11	Device-specific

**[SOURce<[1]>:]BB:TDSCdma:CRATe:VARiation** 1 Mcps ... 5 Mcps

The command enters the output chip rate.

The output chip rate changes the output clock and the modulation bandwidth, as well as the synchronization signals that are output. It does not affect the calculated chip sequence.

**Example:** "BB:TDSC:CRAT:VAR 4086001"  
'sets the chip rate to 4.08 Mcps.

*RST value	Resolution	Options	SCPI
1.28	1 Hz	B10/B11 and B13 K50 SOURce2 only with second option B10/11	Device-specific

**[SOURce<[1]>:]BB:TDSCdma:FILTer:PARAMeter:APCO25** 0.05 ... 0.99

The command sets the roll-off factor for filter type APCO25.

**Example:** "BB:TDSC:FILT:PAR:APCO25 0.2"  
'sets the roll-off factor to 0.2 for filter type APCO25.

*RST value	Resolution	Options	SCPI
0.20	0.01	B10/B11 and B13 K50 SOURce2 only with second option B10/11	Device-specific

**[SOURce<[1]>:]BB:TDSCdma:FILTer:PARAMeter:COSSine** 0.05 ... 0.99

The command sets the roll-off factor for the Cosine filter type.

**Example:** "BB:TDSC:FILT:PAR:COS 0.35"  
'sets the roll-off factor to 0.35 for filter type Cosine.

*RST value	Resolution	Options	SCPI
0.35	0.01	B10/B11 and B13 K50 SOURce2 only with second option B10/11	Device-specific

**[SOURce<[1]>:]BB:TDSCdma:FILTer:PARAMeter:GAUSS** 0.15 ... 2.5

The command sets the B x T for the Gauss filter type.

**Example:** "BB:TDSC:FILT:PAR:GAUS 0.5"  
'sets B x T to 0.5 for the Gauss filter type.

*RST value	Resolution	Options	SCPI
0.5	0.01	B10/B11 and B13 K50 SOURce2 only with second option B10/11	Device-specific

[SOURce<[1]>:]BB:TDSCdma:FILTer:PARAmeter:PGAuss 0.15 ... 2.5

The command sets the B x T for the Pure Gauss filter type.

**Example:** "BB:TDSC:FILT:PAR:GAUS 0.5"  
'sets B x T to 0.5 for the Pure Gauss filter type.

*RST value	Resolution	Options	SCPI
0.5	0.01	B10/B11 and B13 K50 SOURce2 only with second option B10/11	Device-specific

[SOURce<[1]>:]BB:TDSCdma:FILTer:PARAmeter:RCOSine 0.05 ... 0.99

The command sets the roll-off factor for the Root Cosine filter type.

**Example:** "BB:TDSC:FILT:PAR:RCOS 0.22"  
'sets the roll-off factor to 0.22 for filter type Root Cosine.

*RST value	Resolution	Options	SCPI
0.22	0.01	B10/B11 and B13 K50 SOURce2 only with second option B10/11	Device-specific

[SOURce<[1]>:]BB:TDSCdma:FILTer:PARAmeter:SPHase 0.15 ... 2.5

The command sets the B x T for the Split Phase filter type.

**Example:** "BB:TDSC:FILT:PAR:SPH 0.5"  
'sets B x T to 0.5 for the Split Phase filter type.

*RST value	Resolution	Options	SCPI
2.00	0.01	B10/B11 and B13 K50 SOURce2 only with second option B10/11	Device-specific

[SOURce<[1]>:]BB:TDSCdma:FILTer:TYPE RCOSine | COSine | GAUSSs | LGAuss | PGAuss | CONE | COF705 | COEqualizer | COFequalizer | C2K3x | APCO25 | SPHase | RECTangle

The command selects the filter type. The filter types are described in Chapter 4, Section "[Baseband Filter - Custom Digital Mod](#)".

**Example:** "BB:TDSC:FILT:TYPE RCOS"  
'sets the filter type RCOSine.

*RST value	Resolution	Options	SCPI
RCOS	-	B10/B11 and B13 K50 SOURce2 only with second option B10/11	Device-specific

**[SOURce<[1]|2>:]BB:TDSCdma:LINK FORWard|DOWN | REVerse|UP**

The command defines the transmission direction. The signal either corresponds to that of a base station (FORWard | DOWN) or that of a mobile station (REVerse | UP).

**Example:** "BB:TDSC:LINK DOWN"  
'the transmission direction selected is base station to mobile station. The signal corresponds to that of a base station.

*RST value	Resolution	Options	SCPI
DOWN	-	B10/B11 and B13 K50 SOURce2 only with second option B9/B10/B11	Device-specific

**[SOURce<[1]|2>:]BB:TDSCdma:POWER:TOTAL?**

The command queries the total power of the active channels. After **Power Adjust**, this power corresponds to 0 dB.

The command is a query command and therefore does not have an \*RST value.

**Example:** "BB:TDSC:POW:TOT?"  
'queries the total power of the active channels.

Response: "-22.5"  
'the total power is -25 dB.

*RST value	Resolution	Options	SCPI
-	-	B10/B11 and B13 K50 SOURce2 only with second option B9/B10/B11	Device-specific

**[SOURce<[1]|2>:]BB:TDSCdma:POWER:ADJust**

The command sets the power of the active channels in such a way that the total power of the active channels is 0 dB. This will not change the power ratio among the individual channels.

The command triggers an action and therefore has no \*RST value and no query form.

**Example:** "BB:TDSC:POW:ADJ"  
'the total power of the active channels is set to 0 dB, the power ratio among the individual channels is unchanged.

*RST value	Resolution	Options	SCPI
-	-	B10/B11 and B13 K50 SOURce2 only with second option B9/B10/B11	Device-specific

**[SOURce<[1]|2>:]BB:TDSCdma:PRAMp:BBONly ON | OFF**

The command activates or deactivates power ramping for the baseband signals.

**Example:** "SOUR:BB:TDSC:PRAM:BBON ON"  
'activates power ramping for the baseband signals.

*RST value	Resolution	Options	SCPI
OFF	-	B10/B11 and B13 K50 SOURce2 only with second option B9/B10/B11	Device-specific

**[SOURce<[1]|2>:]BB:TDSCdma:PRAMp:FDElay -9.0...9.0**

The command sets the offset in the falling edge of the envelope at the end of a burst. A positive value gives a rise to a delay and a negative value causes an advance.

**Example:** "SOUR:BB:TDSC:PRAM:FDEL 8.0"  
'sets the offset in the falling edge of the envelope to 8.0 chips.

*RST value	Resolution	Options	SCPI
0.0	-	B10/B11 and B13 K50 SOURce2 only with second option B9/B10/B11	Device-specific

**[SOURce<[1]|2>:]BB:TDSCdma:PRAMp:RDElay -9.0...9.0**

The command sets the offset in the falling edge of the envelope at the end of a burst. A positive value gives a rise to a delay and a negative value causes an advance.

**Example:** "SOUR:BB:TDSC:PRAM:RDEL 8.0"  
'sets the offset in the rising edge of the envelope to 8.0 chips.

*RST value	Resolution	Options	SCPI
0.0	-	B10/B11 and B13 K50 SOURce2 only with second option B9/B10/B11	Device-specific

[SOURce<[1]>:]BB:TDSCdma:PRAMP:SHAPE LINear | COSine

The command selects the form of the transmitted power, i.e. the shape of the rising and falling edges during power ramp control.

**Example:** "SOUR:BB:TDSC:PRAM:SHAP LIN"  
 'sets linear shape for the rising and falling edges during power ramp control.

*RST value	Resolution	Options	SCPI
COSine	-	B10/B11 and B13 K50 SOURce2 only with second option B9/B10/B11	Device-specific

[SOURce<[1]>:]BB:TDSCdma:PRAMP:TIME 0.3...16.0

The command sets the power ramping rise time and fall time for a burst.

**Example:** "SOUR:BB:TDSC:PRAM:TIME 2.0"  
 'sets the power ramping rise time and fall time for a burst to 2 chips.

*RST value	Resolution	Options	SCPI
2.0	-	B10/B11 and B13 K50 SOURce2 only with second option B9/B10/B11	Device-specific

[SOURce<[1]>:]BB:TDSCdma:PRESet

The command produces a standardized default for the TD-SCDMA standard. The settings correspond to the \*RST values specified for the commands.

This command triggers an action and therefore has no \*RST value and no query form.

**Example:** "BB:TDSC:PRES"  
 'resets all the TD-SCDMA settings to default values.

*RST value	Resolution	Options	Options	SCPI
-	-	B10/B11 and B13 K50 SOURce2 only with second option B9/B10/B11	All TD-SCDMA settings are preset. An overview is provided by Table in Chapter 4, Section "General Settings for TD-SCDMA Signals".	Device-specific

[SOURce<[1]|2>:]BB:TDSCdma:RESet

The command resets all cells to the predefined settings. The reset applies to the selected link direction..

This command triggers an action and therefore has no \*RST value and no query form.

**Example:** "BB:TDSC:RES"  
'resets all the cells to the predefined settings.

*RST value	Resolution	Options	Options	SCPI
-	-	B10/B11 and B13 K50 SOURce2 only with second option B9/B10/B11	All cells are reset. An overview is provided by Table in Chapter 4, Section "General Settings for TD-SCDMA Signals".	Device-specific

[SOURce<[1]|2>:]BB:TDSCdma:SEquence AUTO | RETRigger | AAUTo | ARETrigger | SINGle

The command selects the trigger mode.

**Parameters:** **AUTO**  
The modulation signal is generated continuously.

**RETRigger**  
The modulation signal is generated continuously. A trigger event (internal or external) causes a restart.

**AAUTo**  
The modulation signal is generated only when a trigger event occurs. After the trigger event the signal is generated continuously, signal generation is stopped with command SOUR:BB:TDSC:TRIG:ARM:EXEC and started again when a trigger event occurs.

**ARETrigger**  
The modulation signal is generated only when a trigger event occurs. The device automatically toggles to RETRIG mode. Every subsequent trigger event causes a restart.  
Signal generation is stopped with command SOUR:BB:TDSC:TRIG:ARM:EXEC and started again when a trigger event occurs.

**SINGle**  
The modulation signal is generated only when a trigger) event occurs. After the trigger event, the signal is generated once to the set sequence length (SOUR:BB:TDSC:TRIG:SLEN). Every subsequent trigger event causes a restart.

**Example:** "BB:TDSC:SEQ AAUT"  
'sets the **Armed\_auto** trigger mode; the device waits for the first trigger (e.g. with \*TRG) and then generates the signal continuously.

*RST value	Resolution	Options	SCPI
AUTO	-	B10/B11 and B13 K50 SOURce2 only with second option B9/B10/B11	Device-specific



**[SOURce<[1]>:]BB:TDSCdma:SETting:CATalog?**

This command reads out the files with TD-SCDMA settings in the default directory. The default directory is set using command `M MEM:CDIRectory`. A path can also be specified, in which case the files in the specified directory are read. Only files with the file extension `*.tdscdma` will be listed.

The command is a query command and therefore has no `*RST` value.

**Example:** `"M MEM:CDIR 'D:\user\tdscdma'"`  
 'sets the default directory to D:\user\tdscdma.  
`"BB:TDSC:SETT:CAT?"`  
 'reads out all the files with TD-SCDMA settings in the default directory.  
 Response: `"'TDSCDMA_UP', 'TDSCDMA_DN'"`  
 'the files 'TDSCDMA\_UP' and 'TDSCDMA\_DN' are available.

*RST value	Resolution	Options	SCPI
-	-	B10/B11 and B13 K50 SOURce2 only with second option B9/B10/B11	Device-specific

**[SOURce<[1]>:]BB:TDSCdma:SETting:DELeTe <file\_name>**

This command deletes the selected file with TD-SCDMA settings. The directory is set using command `M MEM:CDIRectory`. A path can also be specified, in which case the files in the specified directory are read. The file extension may be omitted. Only files with the file extension `*.tdscdma` will be deleted.

This command triggers an event and therefore has no `*RST` value and no query form.

**Example:** `"BB:TDSC:SETT:DEL 'D:\user\tdscdma'"`  
 'deletes the specified file with TD-SCDMA settings.

*RST value	Resolution	Options	SCPI
-	-	B10/B11 and B13 K50 SOURce2 only with second option B9/B10/B11	Device-specific

**[SOURce<[1]>:]BB:TDSCdma:SETting:LOAD <file\_name>**

This command loads the selected file with TD-SCDMA settings. The directory is set using command `M MEM:CDIRectory`. A path can also be specified, in which case the files in the specified directory are read. The file extension may be omitted. Only files with the file extension `*.tdscdma` will be loaded.

This command triggers an event and therefore has no `*RST` value and no query form.

**Example:** `"BB:TDSC:SETT:LOAD 'tdscdma_1'"`  
 'loads file 'tdscdma\_1'.

*RST value	Resolution	Options	SCPI
-	-	B10/B11 and B13 K50 SOURce2 only with second option B9/B10/B11	Device-specific

[SOURce<[1]|2>:]BB:TDSCdma:SETting:STORe <file\_name>

This command stores the current TD-SCDMA settings into the selected file. The directory is set using command `MMEM:CDIRectory`. A path can also be specified, in which case the files in the specified directory are read. Only the file name has to be entered. TD-SCDMA settings are stored as files with the specific file extensions `*.tdscdma`.

This command triggers an event and therefore has no `*RST` value and no query form.

**Example:** `"BB:TDSC:SETT:STOR 'tdscdma_1'"`  
 'stores the current TD-SCDMA settings into file 'tdscdma\_1'.

*RST value	Resolution	Options	SCPI
-	-	B10/B11 and B13 K50 SOURce2 only with second option B9/B10/B11	Device-specific

[SOURce<[1]|2>:]BB:TDSCdma:SLENgth 1 ... 5000 frames

The command sets the sequence length of the arbitrary waveform component of the TD-SCDMA signal in the number of frames. This component is calculated in advance and output in the arbitrary waveform generator. It is added to the realtime signal components.

**Example:** `"BB:TDSC:SLEN 10"`  
 'sets the sequence length to 10 frames.

*RST value	Resolution	Options	SCPI
1	-	B10/B11 and B13 K50 SOURce2 only with second option B9/B10/B11	Device-specific

[SOURce<[1]|2>:]BB:TDSCdma:STATe ON | OFF

The command activates modulation in accordance with the TD-SCDMA standard. Activating this standard deactivates all the other digital standards and digital modulation modes on the same path.

**Example:** `"BB:TDSC:STAT ON"`  
 'activates modulation in accordance with the TD-SCDMA standard.

*RST value	Resolution	Options	Dependencies	SCPI
OFF	-	B10/B11 and B13 K50 SOURce2 only with second option B9/B10/B11	BB:TDSC:STAT ON deactivates the other standards and digital modulation.	Device-specific

**[SOURce<[1]]2>:]BB:TDSCdma:TRIGger:ARM:EXECute**

The command stops signal generation for trigger modes **Armed Auto** and **Armed Retrigger**. A subsequent internal or external trigger event restart signal generation.

This command triggers an event and therefore has no \*RST value and no query form.

**Example:** "BB:TDSC:TRIG:ARM:EXEC"  
'stops signal generation for trigger modes **Armed Auto** and **Armed Retrigger**.

*RST value	Resolution	Options	SCPI
		B10/B11 and B13 K50 SOURce2 only with second option B9/B10/B11	Device-specific

**[SOURce<[1]]2>:]BB:TDSCdma:TRIGger:EXECute**

The command executes a trigger. The internal trigger source must be selected using the command SOUR:BB:TDSC:TRIG:SOUR INT and a trigger mode other than **AUTO** must be selected using the command SOUR:BB:TDSC:TRIG:SEQ.

This command triggers an event and therefore has no \*RST value and no query form.

**Example:** "BB:TDSC:TRIG:SOUR INT"  
'sets internal triggering.  
"BB:TDSC:TRIG:SEQ RETR"  
'sets Retrigger mode, i.e. every trigger event causes signal generation to restart.  
"BB:TDSC:TRIG:EXEC"  
'executes a trigger.

*RST value	Resolution	Options	SCPI
-		B10/B11 and B13 K50 SOURce2 only with second option B9/B10/B11	Device-specific

**[SOURce<[1]]2>:]BB:TDSCdma:TRIGger[:EXTErnal<[1]]2>:DELay 0 ... 65 535 chips**

The command specifies the trigger delay (expressed as a number of chips) for external triggering. The numeric suffix to EXTErnal distinguishes between the external trigger via the TRIGGER 1 (suffix 1) and TRIGGER 2 (suffix 2) connector.

**Example:** "BB:TDSC:TRIG:SOUR EXT"  
'sets an external trigger via the TRIGGER 1 connector.  
"BB:TDSC:TRIG:DEL 50"  
'sets a delay of 50 symbols for the trigger.

*RST value	Resolution	Options	SCPI
0 chips	1 chip	B10/B11 and B13 K50 SOURce2 only with second option B9/B10/B11	Device-specific

**[SOURce<[1]|2>:]BB:TDSCdma:TRIGger[:EXTErnal<[1]|2>]:INHibit 0 ...67 108 863 chips**

The command specifies the number of chips by which a restart is to be inhibited following a trigger event. This command applies only in the case of external triggering. The numeric suffix to EXTErnal distinguishes between the external trigger via the TRIGGER 1 (suffix 1) and TRIGGER 2 (suffix 2) connector.

**Example:** "BB:TDSC:TRIG:SOUR EXT1"  
 'selects an external trigger via the TRIGGER 1 connector.  
 "BB:TDSC:TRIG:INH 200"  
 'sets a restart inhibit for 200 chips following a trigger event.

*RST value	Resolution	Options	SCPI
0 chips	1 chip	B10/B11 and B13 K50 SOURce2 only with second option B9/B10/B11	Device-specific

**SOURce<[1]|2>:]BB:TDSCdma:TRIGger:OBASband:DELay 0 ... 65 535 chips**

The command specifies the trigger delay (expressed as a number of chips) for triggering by the trigger signal from the second path (two-path instruments only).

**Example:** "BB:TDSC:TRIG:SOUR OBAS"  
 'sets for path A the internal trigger executed by the trigger signal from the second path (path B).  
 "BB:TDSC:TRIG:OBAS:DEL 50"  
 'sets a delay of 50 symbols for the trigger.

*RST value	Resolution	Options	SCPI
0 chips	1 chip	B10/B11 and two options B13 K50	Device-specific

**SOURce<[1]|2>:]BB:TDSCdma:TRIGger:OBASband:INHibit 0 ...67 108 863 chips**

The command specifies the number of chips by which a restart is to be inhibited following a trigger event. This command applies only for triggering by the second path (two-path instruments only).

**Example:** "BB:TDSC:TRIG:SOUR OBAS"  
 'sets for path A the internal trigger executed by the trigger signal from the second path (path B).  
 "BB:TDSC:TRIG:INH 200"  
 'sets a restart inhibit for 200 chips following a trigger event.

*RST value	Resolution	Options	SCPI
0 chips	1 chip	B10/B11 and two options B13 K50	Device-specific

**[SOURce<[1]>:]BB:TDSCdma:TRIGger:OUTPut<[1]...4>:DELay 0 .. (2<sup>32</sup> - 1) chips**

The command defines the delay between the signal on the marker outputs and the start of the signal, expressed in terms of chips. Command `BB:TDSCdma:TRIGger:OUTPut:DELay:FIXed` can be used to restrict the range of values to the dynamic range, i.e. the range within which a delay of the marker signals can be set without restarting the marker and signal.

**Example:** `"BB:TDSC:TRIG:OUTP2:DEL 16000"`  
'sets a delay of 16000 chips for the signal on connector MARKER 2.

*RST value	Resolution	Options	SCPI
0	1 Chip	B10/B11 and B13 K50 SOURce2 only for second option B13	Device-specific

**[SOURce<[1]>:]BB:TDSCdma:TRIGger:OUTPut:DELay:FIXed ON | OFF**

The command restricts the marker delay setting range to the current range. In this range the delay can be set without restarting the marker and signal. If a delay is entered in setting ON but is outside this range, the maximum possible delay is set and an error message is generated.

The numeric suffix in `OUTPut` has no significance for this command, since the setting always affects every marker.

**Example:** `"BB:TDSC:TRIG:OUTP:DEL:FIX ON"`  
'restricts the marker signal delay setting range to the current range.

*RST value	Resolution	Options	SCPI
OFF	-	B10/B11 and B13 K50 SOURce2 only with second option B9/B10/B11	Device-specific

**[SOURce<[1]>:]BB:TDSCdma:TRIGger:OUTPut<[1]...4>:DELay:MAXimum?**

The command queries the maximum marker delay for setting `:BB:TDSC:TRIG:OUTP:DEL:FIX ON`.

The command is a query only and therefore has no \*RST value.

**Example:** `"BB:TDSC:TRIG:OUTP:DEL:FIX ON"`  
'restricts the marker signal delay setting range to the dynamic range.

`"BB:TDSC:TRIG:OUTP:DEL:MAX?"`  
'queries the maximum of the dynamic range.

Response: `"20000"`  
'the maximum for the marker delay setting is 20000 chips.

*RST value	Resolution	Options	SCPI
-	-	B10/B11 and B13 K50 SOURce2 only with second option B9/B10/B11	Device-specific

[SOURce<[1]|2>:]BB:TDSCdma:TRIGger:OUTPut<[1]...4>:DELay:MINimum?

The command queries the minimum marker delay for setting :BB:TDSCdma:TRIGger:OUTPut:DELay:FIXed ON.

The command is a query only and therefore has no \*RST value.

**Example:** "BB:TDSC:TRIG:OUTP:DEL:FIX ON"  
'restricts the marker signal delay setting range to the dynamic range.

"BB:TDSC:TRIG:OUTP:DEL:MIN?"  
'queries the minimum of the dynamic range.

Response: "0"  
'the minimum for the marker delay setting is 0 symbols.

*RST value	Resolution	Options	SCPI
-	-	B10/B11 and B13 K50 SOURce2 only with second option B9/B10/B11	Device-specific

[SOURce<[1]|2>:]BB:TDSCdma:TRIGger:OUTPut<[1]...4>:MODE RFRame | SFNR | CSPeriod | USER | RATio

The command defines the signal for the selected marker output

**Parameters:** **RFRame**  
A marker signal is generated every 10 ms (traffic channel clock).

**SFNR**  
A marker signal is generated at the start of every SFN period (every 4096 frames).

**CSPeriod**  
A marker signal is generated at the start of each arbitrary waveform sequence (depending on the set sequence length). The marker signal is also generated if the signal contains no ARB.

**RATio**  
A regular marker signal corresponding to the Time Off / Time On specifications in the commands  
SOURce:BB:TDSCdma:TRIGger:OUTPut:OFFTime and  
SOURce:BB:TDSCdma:TRIGger:OUTPut:ONTime is generated.

**USER**  
A marker signal is generated at the beginning of every user-defined period.  
The period is defined with command SOUR:BB:TDSC:TRIG:OUTP:PERiod

**Example:** "BB:TDSC:TRIG:OUTP2:MODE RFR"  
'selects the traffic channel clock on output MARKER 2.

*RST value	Resolution	Options	SCPI
RFRame	-	B10/B11 and B13 K50 SOURce2 only with second option B9/B10/B11	Device-specific

**[SOURce<[1]2>:]BB:TDSCdma:TRIGger:OUTPut<[1]...4>:OFFTime** 1 ...  $2^{24} - 1$  (16 777 215) chips

The command sets the number of chips in a period (ON time + OFF time) during which the marker signal in setting `SOURce:BB:TDSCdma:TRIGger:OUTPut:MODE RATio` on the marker outputs is OFF.

**Example:**           `"BB:TDSC:TRIG:OUTP2:OFFT 2000"`  
                          'sets an OFF time of 2000 chips for marker signal 2 on path A.

*RST value	Resolution	Options	SCPI
1 chip	1	B10/B11 and B13 K50 SOURce2 only with second option B9/B10/B11	Device-specific

**[SOURce<[1]2>:]BB:TDSCdma:TRIGger:OUTPut<[1]...4>:ONTime** 1 ...  $2^{24} - 1$  (16 777 215) chips

The command sets the number of chips in a period (ON time + OFF time) during which the marker signal in setting `SOURce:BB:TDSCdma:TRIGger:OUTPut:MODE RATio` on the marker outputs is ON.

**Example:**           `"BB:TDSC:TRIG:OUTP2:ONT 2000"`  
                          'sets an ON time of 2000 chips for marker 2 on path A.

*RST value	Resolution	Options	SCPI
1 chip	1	B10/B11 and B13 K50 SOURce2 only with second option B9/B10/B11	Device-specific

**[SOURce<[1]2>:]BB:TDSCdma:TRIGger:OUTPut<[1]...4>:PERiod** 2 ... ( $2^{32}-1$ ) chips

The command sets the repetition rate for the signal at the marker outputs, expressed in terms of chips. The setting is only valid for selection **USER** in `:BB:TDSC:TRIG:OUTP:MODE`.

**Example:**           `"BB:TDSC:TRIG:OUTP2:MODE USER"`  
                          'selects the user marker for the signal on connector MARKER 2.  
  
                          `"BB:TDSC:TRIG:OUTP2:PER 1600"`  
                          'sets a period of 1600 chips, i.e. the marker signal is repeated every 1600th chip.

*RST value	Resolution	Options	SCPI
12800	1 chip	B10/B11 and B13 K50 SOURce2 only with second option B9/B10/B11	Device-specific

[SOURce<[1]|2>:]BB:TDSCdma:TRIGger:RMODE

The command queries the current status of signal generation for all trigger modes with TD-SCDMA modulation on.

The command is a query command and therefore has no \*RST value.

**Parameter:**       **RUN**  
                           the signal is generated. A trigger event occurred in the triggered mode.

**STOP**  
                           the signal is not generated. A trigger event did not occur in the triggered modes, or signal generation was stopped by the command  
                           :BB:TDSC:TRIG:ARM:EXECute (armed trigger modes only).

**Example:**       SOUR2:BB:TDSC:TRIG:SOUR EXT"  
                           'sets external triggering via the TRIGGER 1 connector for path B of a two-path instrument.

SOUR2:BB:TDSC:TRIG:MODE ARET"  
                           'selects the Armed\_Retrigger mode.

SOUR2:BB:TDSC:TRIG:RMODE?"  
                           'queries the current status of signal generation.

Response: "RUN"  
                           'the signal is generated, an external trigger was executed.

*RST value	Resolution	Options	SCPI
-	-	B10/B11 and B13 K50 SOURce2 only with second option B9/B10/B11	Device-specific

[SOURce<[1]|2>:]BB:TDSCdma:TRIGger:SLENgth 1 ... 2^32-1 (4 294 967 295) chips

The command defines the length of the signal sequence to be output in the **Single** trigger mode (SOUR:BB:TDSC:SEQ SING). The unit is defined with command SOUR:BB:TDSC:TRIG:SLUNit. It is then possible to output deliberately just part of the frame, an exact sequence of the frame, or a defined number of repetitions of the frame.

**Example:**       SOUR2:BB:TDSC:SEQ SING"  
                           'sets trigger mode Single.

SOUR2:BB:TDSC:TRIG:SLUN CHIP"  
                           'sets unit chips for the entry of sequence length.

SOUR2:BB:TDSC:TRIG:SLEN 200"  
                           'sets a sequence length of 200 chips. The first 200 chips of the current frame will be output after the next trigger event.

*RST value	Resolution	Options	SCPI
1 frame length	-	B10/B11 and B13 K50 SOURce2 only with second option B9/B10/B11	Device-specific



**[SOURce<[1]|2>:]BB:TDSCdma:TRIGger:SLUNit FRAME | CHIP | SEQUENCE**

The command defines the unit for the entry of the length of the signal sequence (SOUR:BB:TDSC:TRIG:SLEN) to be output in the **Single** trigger mode (SOUR:BB:TDSC:SEQ SING).

**Example:** SOUR2:BB:TDSC:SEQ SING"  
 'sets trigger mode Single.

SOUR2:BB:TDSC:TRIG:SLUN FRAM"  
 'sets unit frames for the entry of sequence length.

SOUR2:BB:TDSC:TRIG:SLEN 2"  
 'sets a sequence length of 2 frames. The current frame will be output twice after the next trigger event.

*RST value	Resolution	Options	SCPI
SEQUence	-	B10/B11 and B13 K50 SOURce2 only with second option B9/B10/B11	Device-specific

**[SOURce<[1]|2>:]BB:TDSCdma:TRIGger:SOURce INTERNAL | EXTERNAL | BEXTERNAL | OBASeband**

The command selects the trigger source.

**Parameter: INTERNAL**  
 Triggering is executed by means of the Trigger command SOURce<[1]|2>:BB:TDSCdma:TRIGger:EXECute or \*TRG in the case of remote control and by means of **Execute Trigger** in the case of manual operation.

**EXTERNAL**  
 Triggering is executed by means of the signal on the TRIGGER 1 connector.

**BEXTERNAL**  
 Triggering is executed by means of the signal on the TRIGGER 2 connector.

**OBASeband**  
 Triggering is executed by means of the trigger signal from the second path (two-path instruments only).

**Example:** "BB:TDSC:TRIG:SOUR EXT"  
 'executes triggering by means of the signal on the TRIGGER 1 connector.

Response: "Release C"  
 'TD-SCDMA Release 6

*RST value	Resolution	Options	SCPI
INTernal	-	B10/B11 and B13 K50 SOURce2 only with second option B9/B10/B11	Device-specific

[SOURce<[1]>:]BB:TDSCdma:VERSion?

The command queries the version of the TD\_SCDMA standard underlying the definitions.

The command is a query command and therefore does not have an \*RST value.

**Example:** "BB:TDSC:VERS?"  
'queries the TD-SCDMA version.

Response: "Release C"  
'TD-SCDMA Release 6

*RST value	Resolution	Options	SCPI
-	-	B10/B11 and B13 K50	Device-specific

[SOURce<[1]>:]BB:TDSCdma:WAVEform:CREate <file\_name>

This command creates a waveform using the current settings of the **TD-SCDMA** menu. The file name is entered with the command. The file is stored with the predefined file extension \*.**wv**. The file name and the directory it is stored in are user-definable.

This command triggers an event and therefore has no \*RST value and no query form.

**Example:** "MMEM:CDIR 'D:\user\waveform'  
'sets the default directory to D:\user\waveform.  
"BB:TDSC:WAV:CRE 'tdscdma\_1'"  
'creates the waveform file tdscdma.wv in the default directory.

*RST value	Resolution	Options	SCPI
-	-	B10/B11 and B13 K50 SOURce2 only with second option B9/B10/B11	device-specific

## SOURce:BB:TDSCdma - Predefined Settings

The R&S Vector Signal Generator gives you the opportunity to generate predefined test settings for cell 1: These predefined settings enable the creation of highly complex scenarios with just a few keystrokes. The settings take effect only after execution of command

[SOURce<[1]|2>:]BB:TDSCdma:PPARameter:EXECute.

Command	Parameter	Default Unit	Comments
[SOURce<[1] 2>:]BB:TDSCdma:DOWN   UP:PPARameter:DPCH:COUNT	1...48		
[SOURce<[1] 2>:]BB:TDSCdma:DOWN   UP:PPARameter:DPCH:CRESt	MINimum   AVERAge   WORSt		
[SOURce<[1] 2>:]BB:TDSCdma:DOWN   UP:PPARameter:DPCH:SFACTOR	1   2   4   8   16		
[SOURce<[1] 2>:]BB:TDSCdma:DOWN   UP:PPARameter:EXECute			No query
[SOURce<[1] 2>:]BB:TDSCdma:DOWN:PPARameter:PCCPch:STATE	ON   OFF		

### [SOURce<[1]|2>:]BB:TDSCdma:DOWN | UP:PPARameter:DPCH:COUNT 1...48

This command sets the number of activated DPCHs. The minimum number is one and the maximum number depends on the spreading factor:

Max. No. DPCH = 3 x Spreading Factor

**Example:** "BB:TDSC:DOWN:PPAR:DPCH:COUN 48"  
'selects if P-CCPCH is used in the scenario or not.

*RST value	Resolution	Options	SCPI
12	-	B10/B11 and B13 K50 SOURce2 only with second option B9/B10/B11	Device-specific

[SOURce<[1]|2>:]BB:TDSCdma:DOWN | UP:PPARameter:DPCH:CRESt MINimum | AVERage | WORSt

This commands selects the desired range for the crest factor of the test scenario. The crest factor of the signal is kept in the desired range by automatically setting appropriate channelization codes and timing offsets. The setting takes effect only after execution of command : SOURce:BB:TDSC:DOWN | UP:PPARameter:EXEC.

**Parameter: MINimum**

The crest factor is minimized. The channelization codes are distributed uniformly over the code domain. The timing offsets are increased by 3 per channel.

**AVERage**

An average crest factor is set. The channelization codes are distributed uniformly over the code domain. The timing offsets are all set to 0.

**WORSt**

The crest factor is set to an unfavorable value (i.e. maximum). The channelization codes are assigned in ascending order. The timing offsets are all set to 0.

**Example:** "BB:TDSC:DOWN:PPAR:DPCH:CRES WORSt"  
'sets the crest factor to an unfavorable value.'

*RST value	Resolution	Options	SCPI
MINimum	-	B10/B11 and B13 K50 SOURce2 only with second option B9/B10/B11	Device-specific

[SOURce<[1]|2>:]BB:TDSCdma:DOWN | UP:PPARameter:DPCH:SFAC 1 | 2 | 4 | 8 | 16

This command sets the the spreading factor for the DPCHs.

Max. No. DPCH = 3 x Spreading Factor

**Example:** "BB:TDSC:DOWN | UP:PPAR:DPCH:SFAC 16"  
'sets the the spreading factor for the DPCH.'

*RST value	Resolution	Options	SCPI
16	-	B10/B11 and B13 K50 SOURce2 only with second option B9/B10/B11	Device-specific

**[SOURce<[1]2>:]BB:TDSCdma:DOWN | UP:PPARameter:EXECute**

This command presets the channel table of cell 1 with the parameters defined by the PPARameter commands. Scrambling Code 0 is automatically selected.

The command triggers an event and therefore has no query form and no \*RST value.

**Example:** "BB:TDSC:DOWN:PPAR:EXEC"  
 'configures the signal sequence as defined by the :BB:TDSC:PPARameter commands.

*RST value	Resolution	Options	SCPI
-	-	B10/B11 and B13 K50 SOURce2 only with second option B9/B10/B11	Device-specific

**[SOURce<[1]2>:]BB:TDSCdma:DOWN:PPARameter:PCCPch:STATE ON | OFF**

This command defines, if P-CCPCH is used in the scenario or not. If P-CCPCH is used, both P-CCPCHs are activated in slot 0 with spreading code 0+1.

**Example:** "BB:TDSC:DOWN:PPAR:PCCP:STAT ON"  
 'selects if P-CCPCH is used in the scenario or not.

*RST value	Resolution	Options	SCPI
ON	-	B10/B11 and B13 K50 SOURce2 only with second option B9/B10/B11	Device-specific

## SOURce:BB:TDSCdma – Cell Settings

Command	Parameter	Default Unit	Comments
[SOURce<[1]>:]BB:TDSCdma:DOWN   UP:CELL<[1]>:DWPTs:POWer	-80 dB...10dB		
[SOURce<[1]>:]BB:TDSCdma:DOWN   UP:CELL<[1]>:MCODe			Query only
[SOURce<[1]>:]BB:TDSCdma:DOWN   UP:CELL<[1]>:SCODe	0...127		
[SOURce<[1]>:]BB:TDSCdma:DOWN   UP:CELL<[1]>:SCODe:STATe	ON   OFF		
[SOURce<[1]>:]BB:TDSCdma:DOWN   UP:CELL<[1]>:SLOT<[0]>	ON   OFF		
[SOURce<[1]>:]BB:TDSCdma:DOWN   UP:CELL<[1]>:SPOInt	1...6		
[SOURce<[1]>:]BB:TDSCdma:DOWN   UP:CELL<[1]>:STATe	ON   OFF		
[SOURce<[1]>:]BB:TDSCdma:DOWN   UP:CELL<[1]>:SYNDI			Query only
[SOURce<[1]>:]BB:TDSCdma:DOWN   UP:CELL<[1]>:SYNUI	0...255		
[SOURce<[1]>:]BB:TDSCdma:DOWN   UP:CELL<[1]>:USERs	2   4   6   8   10   12   14   16		

### [SOURce<[1]>:]BB:TDSCdma:DOWN | UP:CELL<[1]>:DWPTs:POWer -80 dB...10 dB

The command sets the power of the downlink pilot time slot.

**Example:** "BB:TDSC:DOWN:CELL1:DWPT:POW -12.5"  
'sets the power of the downlink pilot slot.

*RST value	Resolution	Options	SCPI
0	-	B10/B11 and B13 K50 SOURce2 only with second option B9/B10/B11	Device-specific

### [SOURce<[1]>:]BB:TDSCdma:DOWN | UP:CELL<[1]>:MCODe?

The command queries the basic midamble code id. The value is set automatically by the change of the scrambling code parameter (it is equal to scrambling code).

The command is a query command and therefore does not have an \*RST value.

**Example:** "BB:TDSC:DOWN:CELL1:SCOD 15"  
'queries the basic midamble code id.

*RST value	Resolution	Options	SCPI
-	-	B10/B11 and B13 K50 SOURce2 only with second option B9/B10/B11	Device-specific

**[SOURce<[1]>:]BB:TDSCdma:DOWN | UP:CELL<[1]>[2]>[3]>[4]>:SCODE 0...127**

The command sets the scrambling code. The scrambling code is used for transmitter-dependent scrambling of the chip sequence.

**Example:** "BB:TDSC:DOWN:CELL1:SCOD 15"  
'sets the scrambling code for cell 1.

*RST value	Resolution	Options	SCPI
0	-	B10/B11 and B13 K50 SOURce2 only with second option B9/B10/B11	Device-specific

**[SOURce<[1]>:]BB:TDSCdma:DOWN | UP:CELL<[1]>[2]>[3]>[4]>:SCODE:STATe ON | OFF**

The command activates or deactivates the scrambling code. The scrambling code is deactivated, for example, for test purposes.

**Example:** "BB:TDSC:DOWN:CELL1:SCOD:STAT ON"  
'activates the scrambling code for cell 1.

*RST value	Resolution	Options	SCPI
ON	-	B10/B11 and B13 K50 SOURce2 only with second option B9/B10/B11	Device-specific

**[SOURce<[1]>:]BB:TDSCdma:DOWN | UP:CELL<[1]>[2]>[3]>[4]>:SLOT<[0] 6> ON | OFF**

The command activates and deactivates the slot in the subframe.

**Example:** "BB:TDSC:DOWN:CELL1:SLOT0:STAT ON"  
'activates slot0.

*RST value	Resolution	Options	SCPI
OFF	-	B10/B11 and B13 K50 SOURce2 only with second option B9/B10/B11	Device-specific

**[SOURce<[1]>:]BB:TDSCdma:DOWN | UP:CELL<[1]>[2]>[3]>[4]>:SPOInt 1...6**

The command sets the switching point between the uplink slots and the the downlink slots in the frame.

**Example:** "BB:TDSC:DOWN:CELL1:SPOI 4"  
'sets the switching point in the frame.

*RST value	Resolution	Options	SCPI
3	-	B10/B11 and B13 K50 SOURce2 only with second option B9/B10/B11	Device-specific

[SOURce<[1]>:]BB:TDSCdma:DOWN | UP:CELL<[1]>|2|3|4>:STATe ON | OFF

The command activates and deactivates the specified cell.

**Example:** "BB:TDSC:DOWN:CELL1:STAT ON"  
'activates cell 1.'

*RST value	Resolution	Options	SCPI
OFF	-	B10/B11 and B13 K50 SOURce2 only with second option B9/B10/B11	Device-specific

[SOURce<[1]>:]BB:TDSCdma:DOWN | UP:CELL<[1]>|2|3|4>:SYNDI?

The command queries the SYNC-DL code. The SYNC-DL code is transmitted in the DwPTS to synchronize the mobile station to the base station. The SYNC-DL code is derived from the scrambling code and the basic midamble code ID.

The command is a query command and therefore does not have an \*RST value.

**Example:** "BB:TDSC:DOWN:CELL1:SYND?"  
'queries the SYNC-DL code.'

*RST value	Resolution	Options	SCPI
-	-	B10/B11 and B13 K50 SOURce2 only with second option B9/B10/B11	Device-specific

[SOURce<[1]>:]BB:TDSCdma:DOWN | UP:CELL<[1]>|2|3|4>:SYNUI 0...255

The command sets the SYNC-UL code. The SYNC-UL code is transmitted in the UpPTS to synchronize the base station to the mobile station.

**Example:** "BB:TDSC:DOWN:CELL1:SYNU 120"  
'sets the SYNC-UL code.'

*RST value	Resolution	Options	SCPI
-	-	B10/B11 and B13 K50 SOURce2 only with second option B9/B10/B11	Device-specific

[SOURce<[1]>:]BB:TDSCdma:DOWN | UP:CELL<[1]>|2|3|4>:USERS 2 | 4 | 6 | 8 | 10 | 12 | 14 | 16

The command sets the total number of users of the cell.

**Example:** "BB:TDSC:DOWN:CELL1:USER 4"  
'sets the total number of users.'

*RST value	Resolution	Options	SCPI
16	-	B10/B11 and B13 K50 SOURce2 only with second option B9/B10/B11	Device-specific



## SOURCE:BB:TDSCdma – Enhanced Channels of Cell 1

Command	Parameter	Default Unit	Comments
[SOURCE<[1]>:]BB:TDSCdma:DOWN   UP:CELL1:ENH:DCH:BIT:LAYer	TRANsport   PHYSical		
[SOURCE<[1]>:]BB:TDSCdma:DOWN   UP:CELL1:ENH:DCH:BIT:RATE	1E-7...5E-1		
[SOURCE<[1]>:]BB:TDSCdma:DOWN   UP:CELL1:ENH:DCH:BIT:STATe	ON   OFF		
[SOURCE<[1]>:]BB:TDSCdma:DOWN   UP:CELL1:ENH:DCH:BLOCK:RATE	10E-4...10E-1		
[SOURCE<[1]>:]BB:TDSCdma:DOWN   UP:CELL1:ENH:DCH:BLOCK:STATe	ON   OFF		
[SOURCE<[1]>:]BB:TDSCdma:DOWN   UP:CELL1:ENH:DCH:BPFRame			Query only
[SOURCE<[1]>:]BB:TDSCdma:DOWN   UP:CELL1:ENH:DCH:DTCH   DCCH:CRCSIZE			Query only
[SOURCE<[1]>:]BB:TDSCdma:DOWN   UP:CELL1:ENH:DCH:DTCH   DCCH:DATA	PN9   PN11   PN15   PN16   PN20   PN21   PN23   DLISt   ZERO   ONE   PATTerN		
[SOURCE<[1]>:]BB:TDSCdma:DOWN   UP:CELL1:ENH:DCH:DTCH   DCCH:DATA:DSElect	<data list name>		
[SOURCE<[1]>:]BB:TDSCdma:DOWN   UP:CELL1:ENH:DCH:DTCH   DCCH:DATA:PATTerN	#B0,1 ... #B111..1,64		
[SOURCE<[1]>:]BB:TDSCdma:DOWN   UP:CELL1:ENH:DCH:DTCH   DCCH:EPROtection			Query only
[SOURCE<[1]>:]BB:TDSCdma:DOWN   UP:CELL1:ENH:DCH:DTCH   DCCH:INTOne			Query only
[SOURCE<[1]>:]BB:TDSCdma:DOWN   UP:CELL1:ENH:DCH:DTCH   DCCH:INTTwo			Query only
[SOURCE<[1]>:]BB:TDSCdma:DOWN   UP:CELL1:ENH:DCH:DTCH   DCCH:RMATtribute			Query only
[SOURCE<[1]>:]BB:TDSCdma:DOWN   UP:CELL1:ENH:DCH:DTCH   DCCH:STATe			Query only
[SOURCE<[1]>:]BB:TDSCdma:DOWN   UP:CELL1:ENH:DCH:DTCH   DCCH:TBCount			Query only
[SOURCE<[1]>:]BB:TDSCdma:DOWN   UP:CELL1:ENH:DCH:DTCH   DCCH:TBSIZE			Query only
[SOURCE<[1]>:]BB:TDSCdma:DOWN   UP:CELL1:ENH:DCH:DTCH   DCCH:TTINterval			Query only
[SOURCE<[1]>:]BB:TDSCdma:DOWN   UP:CELL1:ENH:DCH:HSCH:CVPB			Query only
[SOURCE<[1]>:]BB:TDSCdma:DOWN   UP:CELL1:ENH:DCH:HSCH:PRSR			Query only
[SOURCE<[1]>:]BB:TDSCdma:DOWN   UP:CELL1:ENH:DCH:HSCH:PSBS			Query only
[SOURCE<[1]>:]BB:TDSCdma:DOWN   UP:CELL1:ENH:DCH:HSCH:RVParameter	0...7		
[SOURCE<[1]>:]BB:TDSCdma:DOWN   UP:CELL1:ENH:DCH:RUPLayer			Query only
[SOURCE<[1]>:]BB:TDSCdma:DOWN   UP:CELL1:ENH:DCH:SCSMODE	AUTO   USER		
[SOURCE<[1]>:]BB:TDSCdma:DOWN   UP:CELL1:ENH:DCH:SFOR			Query only

Command	Parameter	Default Unit	Comments
[SOURce<[1]>:]BB:TDSCdma:DOWN   UP:CELL1:ENH:DCH:SLOTstate<[0]...6>			Query only
[SOURce<[1]>:]BB:TDSCdma:DOWN   UP:CELL1:ENH:DCH:STATE	ON   OFF		
[SOURce<[1]>:]BB:TDSCdma:DOWN   UP:CELL1:ENH:DCH:TYPE	RMC12K2   RM64K   RMC144K   RMC384K   RMC2048K   HRMC526K   HRMC730K   UP_RMC12K2   UP_RMC64K   UP_RMC144K		
[SOURce<[1]>:]BB:TDSCdma:DOWN:CELL1:ENH:BCH:BPFFrame			Query only
[SOURce<[1]>:]BB:TDSCdma:DOWN:CELL1:ENH:BCH:DTCH:CRCSize			Query only
[SOURce<[1]>:]BB:TDSCdma:DOWN:CELL1:ENH:BCH:DTCH:DATA	PN9   PN11   PN15   PN16   PN20   PN21   PN23   DLISt   ZERO   ONE   PATTErn		
[SOURce<[1]>:]BB:TDSCdma:DOWN:CELL1:ENH:BCH:DTCH:DATA:DSElect	<data list name>		
[SOURce<[1]>:]BB:TDSCdma:DOWN:CELL1:ENH:BCH:DTCH:DATA:PATTern	#B0,1 ... #B111..1,64		
[SOURce<[1]>:]BB:TDSCdma:DOWN:CELL1:ENH:BCH:DTCH:EPRotection			Query only
[SOURce<[1]>:]BB:TDSCdma:DOWN:CELL1:ENH:BCH:DTCH:INTOne			Query only
[SOURce<[1]>:]BB:TDSCdma:DOWN:CELL1:ENH:BCH:DTCH:INTTwo			Query only
[SOURce<[1]>:]BB:TDSCdma:DOWN:CELL1:ENH:BCH:DTCH:RMATtribute			Query only
[SOURce<[1]>:]BB:TDSCdma:DOWN:CELL1:ENH:BCH:DTCH:STATE			Query only
[SOURce<[1]>:]BB:TDSCdma:DOWN:CELL1:ENH:BCH:DTCH:TBCount			Query only
[SOURce<[1]>:]BB:TDSCdma:DOWN:CELL1:ENH:BCH:DTCH:TBSize			Query only
[SOURce<[1]>:]BB:TDSCdma:DOWN:CELL1:ENH:BCH:DTCH:TTINterval			Query only
[SOURce<[1]>:]BB:TDSCdma:DOWN:CELL1:ENH:BCH:SCSMode			Query only
[SOURce<[1]>:]BB:TDSCdma:DOWN:CELL1:ENH:BCH:SFOR			Query only
[SOURce<[1]>:]BB:TDSCdma:DOWN:CELL1:ENH:BCH:SLOTstate<[0]...6>			Query only
[SOURce<[1]>:]BB:TDSCdma:DOWN:CELL1:ENH:BCH:STATE	ON   OFF		
[SOURce<[1]>:]BB:TDSCdma:DOWN:CELL1:ENH:BCH:TYPE			Query only

**[SOURce<[1]>:]BB:TDSCdma:DOWN | UP:CELL1:ENH:DCH:BIT:LAYer TRANsport | PHYSical)**

The command sets the layer in the coding process at which bit errors are inserted.

**Example:** "BB:TDSC:DOWN:CELL1:ENH:DCH:BIT:LAY TRAN" inserts the bit errors in the transport layer.

*RST value	Resolution	Options	SCPI
TRANsport	-	B10/B11 and B13 K50 SOURce2 only with second option B9/B10/B11	Device-specific

**[SOURce<[1]>:]BB:TDSCdma:DOWN | UP:CELL1:ENH:DCH:BIT:RATE 1E-7...5E-1)**

The command sets the bit error rate.

**Example:** "BB:TDSC:DOWN:CELL1:ENH:DCH:BIT:RATE 5E-1"  
'sets the bit error rate.

*RST value	Resolution	Options	SCPI
5E-1	-	B10/B11 and B13 K50 SOURce2 only with second option B9/B10/B11	Device-specific

**[SOURce<[1]>:]BB:TDSCdma:DOWN | UP:CELL1:ENH:DCH:BIT:STATe ON | OFF)**

The command activates or deactivates bit error generation.

**Example:** "BB:TDSC:DOWN:CELL1:ENH:DCH:BIT:STAT ON"  
'activates the bit error generation.

*RST value	Resolution	Options	SCPI
OFF	-	B10/B11 and B13 K50 SOURce2 only with second option B9/B10/B11	Device-specific

**[SOURce<[1]>:]BB:TDSCdma:DOWN | UP:CELL1:ENH:DCH:BLOCK:RATE 10E-4...10E-1)**

The command sets the block error rate.

**Example:** "BB:TDSC:DOWN:CELL1:ENH:DCH:BLOCK:RATE 10E-1"  
'sets the block error rate.

*RST value	Resolution	Options	SCPI
10E-1	-	B10/B11 and B13 K50 SOURce2 only with second option B9/B10/B11	Device-specific

**[SOURce<[1]>:]BB:TDSCdma:DOWN | UP:CELL1:ENH:DCH:BLOCK:STATe ON | OFF)**

The command activates or deactivates block error generation. The CRC checksum is determined and then the last bit is inverted at the specified error probability in order to simulate an invalid signal.

**Example:** "BB:TDSC:DOWN:CELL1:ENH:DCH:BLOCK:STAT ON"  
'activates block error generation.

*RST value	Resolution	Options	SCPI
OFF	-	B10/B11 and B13 K50 SOURce2 only with second option B9/B10/B11	Device-specific

[SOURce<[1]|2>:]BB:TDSCdma:DOWN | UP:CELL1:ENH:DCH:BPFRame?

The command queries the data bits in the DPDCH component of the DPCH frame at physical level. The value depends on the slot format.

The command is a query command and therefore does not have an \*RST value.

**Example:** "BB:TDSC:DOWN:CELL1:ENH:DCH:BPFR?"  
'queries the data bits in the DPDCH component of the DPCH frame at physical level.

*RST value	Resolution	Options	SCPI
-	-	B10/B11 and B13 K50 SOURce2 only with second option B9/B10/B11	Device-specific

[SOURce<[1]|2>:]BB:TDSCdma:DOWN | UP:CELL1:ENH:DCH:DTCH | DCCH:CRCSize?

The command queries the type (length) of the CRC.

The command is a query command and therefore does not have an \*RST value.

**Example:** "BB:TDSC:DOWN:CELL1:ENH:DCH:DTCH:CRCS?"  
'queries the type (length) of the CRC.

*RST value	Resolution	Options	SCPI
-	-	B10/B11 and B13 K50 SOURce2 only with second option B9/B10/B11	Device-specific

[SOURce<[1]2>:]BB:TDSCdma:DOWN | UP:CELL1:ENH:DCH:DTCH | DCCH:DATA PN9 | PN11 | PN15 | PN16 | PN20 | PN21 | PN23 | DLISt | ZERO | ONE | PATTern

The command selects the data source for the specified channel.

For the traffic channels, this value is specific for the selected radio configuration.

**Parameter:**

**PNxx**

PRBS data as per CCITT with period lengths between  $2^9-1$  and  $2^{23}-1$  is generated internally.

**DLISt**

Internal data from a programmable data list is used. The data list can be generated by the Data Editor or generated externally. Data lists are selected in the **Select Data List** field. The data list is selected with the command

```
BB:TDSC:DOWN:CELL1:ENH:BCH:DTCH:DATA:DSEL <data list name>
```

**ZERO | ONE**

Internal 0 and 1 data is used.

**PATTern**

A user-definable bit pattern with a maximum length of 64 bits is generated internally. The bit pattern is defined in the **Pattern entry field**. The bit pattern is selected with the command

```
BB:TDSC:DOWN:CELL1:ENH:BCH:DTCH:DATA:PATT <bit pattern>
```

**Example:**

```
"BB:TDSC:DOWN:CELL1:ENH:DCH:DTCH:DATA PN9"
```

'selects PN9 as the data source of the transport channel.

*RST value	Resolution	Options	SCPI
PN9	-	B10/B11 and B13 K50 SOURce2 only with second option B9/B10/B11	Device-specific

[SOURce<[1]|2>:]BB:TDSCdma:DOWN | UP:CELL1:ENH:DCH:DTCH | DCCH:DATA:DSElect  
<data list name>

The command selects the data list for the DLIS data source selection.

The lists are stored as files with the fixed file extensions \*.dm\_iqd in a directory of the user's choice. The directory applicable to the following commands is defined with the command MMEMory:CDIR. To access the files in this directory, you only have to give the file name, without the path and the file extension.

For the traffic channels, this value is specific for the selected radio configuration.

**Example:** "SOUR:BB:TDSC:DOWN:CELL1:ENH:DCH:DTCH:DATA DLIS"  
'selects the Data Lists data source for the transport channel.

"MMEM:CDIR 'D:\Lists\DM\IqData'"  
'selects the directory for the data lists.

"SOUR:BB:TDSC:DOWN:CELL1:ENH:DCH:DTCH:DATA:DSEL 'tdscdma\_1'"  
'selects file 'tdscdma\_1' as the data source. This file must be in the directory D:\Lists\DM\IqData and have the file extension \*.dm\_iqd.

*RST value	Resolution	Options	SCPI
-	-	B10/B11 and B13 K50 SOURce2 only with second option B9/B10/B11	Device-specific

[SOURce<[1]|2>:]BB:TDSCdma:DOWN | UP:CELL1:ENH:DCH:DTCH | DCCH:DATA:PATTern  
#B0,1 ... #B111..1,64

The command sets the bit pattern for the PATTern selection. The first parameter determines the bit pattern (choice of hexadecimal, octal, or binary notation). The second specifies the number of bits to use. The maximum length is 64 bits.

For the traffic channels, this value is specific for the selected radio configuration.

**Example:** "SOUR:BB:TDSC:DOWN:CELL1:ENH:DCH:DTCH:DATA:PATT  
#H800FE038,30"  
'defines the bit pattern.

*RST value	Resolution	Options	SCPI
0	-	B10/B11 and B13 K50 SOURce2 only with second option B9/B10/B11	Device-specific

[SOURce<[1]|2>:]BB:TDSCdma:DOWN | UP:CELL1:ENH:DCH:DTCH | DCCH:EPRotectioN?

The command queries the error protection.

The command is a query command and therefore does not have an \*RST value.

**Example:** "BB:TDSC:DOWN:CELL1:ENH:DCH:DTCH:EPR?"  
'queries the error protection.

*RST value	Resolution	Options	SCPI
-	-	B10/B11 and B13 K50 SOURce2 only with second option B9/B10/B11	Device-specific

[SOURce<[1]>:]BB:TDSCdma:DOWN | UP:CELL1:ENH:DCH:DTCH | DCCH:INTOne?

The command activates or deactivates the channel coding interleaver state 1 of the transport channel. Interleaver state 1 can be set independently in each TCH. Activation does not change the symbol rate.

**Example:** "BB:TDSC:DOWN:CELL1:ENH:DCH:DTCH:INTO ON"  
'activates the channel coding interleaver state 1 of the transport channel.

*RST value	Resolution	Options	SCPI
ON	-	B10/B11 and B13 K50 SOURce2 only with second option B9/B10/B11	Device-specific

[SOURce<[1]>:]BB:TDSCdma:DOWN | UP:CELL1:ENH:DCH:DTCH | DCCH:INTTwo?

The command activates or deactivates the channel coding interleaver state 2 off all the transport channels. Interleaver state 2 can only be set for all the TCHs together. Activation does not change the symbol rate.

**Example:** "BB:TDSC:DOWN:CELL1:ENH:DCH:DTCH:INTT ON"  
'activates the channel coding interleaver state 2 of all the transport channel.

*RST value	Resolution	Options	SCPI
ON	-	B10/B11 and B13 K50 SOURce2 only with second option B9/B10/B11	Device-specific

[SOURce<[1]>:]BB:TDSCdma:DOWN | UP:CELL1:ENH:DCH:DTCH | DCCH:RMATtribute?

The command queries the rate matching.

The command is a query command and therefore does not have an \*RST value.

**Example:** "BB:TDSC:DOWN:CELL1:ENH:DCH:DTCH:RMAT?"  
'queries the rate matching.

*RST value	Resolution	Options	SCPI
-	-	B10/B11 and B13 K50 SOURce2 only with second option B9/B10/B11	Device-specific

[SOURce<[1]>:]BB:TDSCdma:DOWN | UP:CELL1:ENH:DCH:DTCH | DCCH:STATe?

The command queries the state of the transport channel.

The command is a query command and therefore does not have an \*RST value.

**Example:** "BB:TDSC:DOWN:CELL1:ENH:DCH:DTCH:STAT?"  
'queries the state of the transport channel.

*RST value	Resolution	Options	SCPI
-	-	B10/B11 and B13 K50 SOURce2 only with second option B9/B10/B11	Device-specific

[SOURce<[1]>:]BB:TDSCdma:DOWN | UP:CELL1:ENH:DCH:DTCH | DCCH:TBCCount?

The command queries the number of transport blocks for the TCH.

The command is a query command and therefore does not have an \*RST value.

**Example:** "BB:TDSC:DOWN:CELL1:ENH:DCH:DTCH:TBC?"  
'queries the number of transport blocks for the TCH.

*RST value	Resolution	Options	SCPI
-	-	B10/B11 and B13 K50 SOURce2 only with second option B9/B10/B11	Device-specific

[SOURce<[1]>:]BB:TDSCdma:DOWN | UP:CELL1:ENH:DCH:DTCH | DCCH:TBSize?

The command queries the size of the transport block at the channel coding input.

The command is a query command and therefore does not have an \*RST value.

**Example:** "BB:TDSC:DOWN:CELL1:ENH:DCH:DTCH:TBS?"  
'queries the size of transport block of the channel coding input.

*RST value	Resolution	Options	SCPI
-	-	B10/B11 and B13 K50 SOURce2 only with second option B9/B10/B11	Device-specific

[SOURce<[1]>:]BB:TDSCdma:DOWN | UP:CELL1:ENH:DCH:DTCH | DCCH:TTINterval?

The command queries the number of frames into which a TCH is divided. This setting also defines the interleaver depth.

The command is a query command and therefore does not have an \*RST value.

**Example:** "BB:TDSC:DOWN:CELL1:ENH:DCH:DTCH:TTIN?"  
'queries the number of frames into which a TCH is divided.

*RST value	Resolution	Options	SCPI
-	-	B10/B11 and B13 K50 SOURce2 only with second option B9/B10/B11	Device-specific

[SOURce<[1]>:]BB:TDSCdma:DOWN | UP:CELL1:ENH:DCH:HSCH:CVPB?

The command queries the constellation version parameter - b. This value depends on the redundancy version parameter.

The command is a query command and therefore does not have an \*RST value.

**Example:** "SOUR:BB:TDSC:DOWN:CELL1:ENH:DCH:HSCH:CVPB?"  
'queries the constellation version parameter - b.

*RST value	Resolution	Options	SCPI
-	-	B10/B11 and B13 K50 SOURce2 only with second option B9/B10/B11	Device-specific



**[SOURce<[1]>:]BB:TDSCdma:DOWN | UP:CELL1:ENH:DCH:HSCH:PRSR?**

The command queries the puncturing and repetition scheme - r. This value depends on the redundancy version parameter.

The command is a query command and therefore does not have an \*RST value.

**Example:** "SOUR:BB:TDSC:DOWN:CELL1:ENH:DCH:HSCH:PRSR?"  
 'queries the puncturing and repetition scheme - r.

*RST value	Resolution	Options	SCPI
-	-	B10/B11 and B13 K50 SOURce2 only with second option B9/B10/B11	Device-specific

**[SOURce<[1]>:]BB:TDSCdma:DOWN | UP:CELL1:ENH:DCH:HSCH:PSBS?**

The command queries the prioritisation of systematic bits – s. This value depends on the redundancy version parameter.

The command is a query command and therefore does not have an \*RST value.

**Example:** "SOUR:BB:TDSC:DOWN:CELL1:ENH:DCH:HSCH:PSBS?"  
 'queries the prioritisation of systematic bits – s.

*RST value	Resolution	Options	SCPI
-	-	B10/B11 and B13 K50 SOURce2 only with second option B9/B10/B11	Device-specific

**[SOURce<[1]>:]BB:TDSCdma:DOWN | UP:CELL1:ENH:DCH:HSCH:RVParameter 0...7**

The command sets the redundancy version parameter. This parameter indicates which redundancy version of the data is sent.

**Example:** "SOUR:BB:TDSC:DOWN:CELL1:ENH:DCH:HSCH:RVParameter 3"  
 'sets the redundancy version parameter to 3.

*RST value	Resolution	Options	SCPI
0	-	B10/B11 and B13 K50 SOURce2 only with second option B9/B10/B11	Device-specific

**[SOURce<[1]>:]BB:TDSCdma:DOWN | UP:CELL1:ENH:DCH:RUPLayer?**

The command queries the resource units on the physical layer needed to generate the selected channel.

The command is a query command and therefore does not have an \*RST value.

**Example:** "BB:TDSC:DOWN:CELL1:ENH:DCH:RUPL?"  
 'queries the resource units on the physical layer needed to generate the selected channel.

*RST value	Resolution	Options	SCPI
-	-	B10/B11 and B13 K50 SOURce2 only with second option B9/B10/B11	Device-specific

**[SOURce<[1]>:]BB:TDSCdma:DOWN | UP:CELL1:ENH:DCH:SCSMMode AUTO | USER**

The command sets the spreading code selection mode for the used transport channels.

**Example:** "BB:TDSC:DOWN:CELL1:ENH:DCH:SCSM AUTO"  
 'queries the spreading code.

*RST value	Resolution	Options	SCPI
AUTO	-	B10/B11 and B13 K50 SOURce2 only with second option B9/B10/B11	Device-specific

**[SOURce<[1]>:]BB:TDSCdma:DOWN | UP:CELL1:ENH:DCH:SFOR?**

The command queries the slot format of the selected channel. A slot format defines the complete structure of a slot made of data and control fields and includes the symbol rate. The slot format (and thus the symbol rate, the pilot length, and the TFCI State) depends on the coding type selected.

The command is a query command and therefore does not have an \*RST value.

**Example:** "BB:TDSC:DOWN:CELL1:ENH:DCH:SFOR?"  
 'queries the channel coding type.

*RST value	Resolution	Options	SCPI
-	-	B10/B11 and B13 K50 SOURce2 only with second option B9/B10/B11	Device-specific

**[SOURce<[1]>:]BB:TDSCdma:DOWN | UP:CELL1:ENH:DCH:SLOTstate<[0]...6>?**

The command queries the state of the slots off cell 1 used to transmit the transport channel.

The command is a query command and therefore does not have an \*RST value.

**Example:** "BB:TDSC:DOWN:CELL1:ENH:DCH:SLOT 3?"  
'queries the state of slot 3.

*RST value	Resolution	Options	SCPI
-	-	B10/B11 and B13 K50 SOURce2 only with second option B9/B10/B11	Device-specific

**[SOURce<[1]>:]BB:TDSCdma:DOWN | UP:CELL1:ENH:DCH:STATE ON | OFF**

The command activates or deactivates the enhanced state for the DCH channel coding.

**Example:** "BB:TDSC:DOWN:CELL1:ENH:DCH:STAT ON"  
'deactivates the enhanced state for the DCH channel.

*RST value	Resolution	Options	SCPI
OFF	-	B10/B11 and B13 K50 SOURce2 only with second option B9/B10/B11	Device-specific

**[SOURce<[1]>:]BB:TDSCdma:DOWN | UP:CELL1:ENH:DCH:TYPE RMC12K2 | RM64K | RMC144K | RMC384K | RMC2048K | HRMC526K | HRMC730K | UP\_RMC12K2 | UP\_RMC64K | UP\_RMC144K**

The command sets the channel coding type.

**Example:** "BB:TDSC:DOWN:CELL1:ENH:DCH:TYPE RMC12K2"  
'sets the channel coding type to RMC12K2.

*RST value	Resolution	Options	SCPI
RMC12K2	-	B10/B11 and B13 K50 SOURce2 only with second option B9/B10/B11	Device-specific

**[SOURce<[1]>:]BB:TDSCdma:DOWN:CELL1:ENH:BCH:BPFRame?**

The command queries the data bits in the DPDCH component of the DPCH frame at physical level.  
The value depends on the slot format.

The command is a query command and therefore does not have an \*RST value.

**Example:** "BB:TDSC:DOWN:CELL1:ENH:BCH:BPFR?"  
'queries the data bits in the DPDCH component of the DPCH frame at physical level.

*RST value	Resolution	Options	SCPI
-	-	B10/B11 and B13 K50 SOURce2 only with second option B9/B10/B11	Device-specific

[SOURce<[1]|2>:]BB:TDSCdma:DOWN:CELL1:ENH:BCH:DTCH:CRCSize?

The command queries the type (length) of the CRC.

The command is a query command and therefore does not have an \*RST value.

**Example:** "BB:TDSC:DOWN:CELL1:ENH:BCH:DTCH:CRCS?"  
'queries the type (length) of the CRC.'

*RST value	Resolution	Options	SCPI
-	-	B10/B11 and B13 K50 SOURce2 only with second option B9/B10/B11	Device-specific

[SOURce<[1]|2>:]BB:TDSCdma:DOWN:CELL1:ENH:BCH:DTCH:DATA PN9 | PN11 | PN15 | PN16 | PN20 | PN21 | PN23 | DLISt | ZERO | ONE | PATTErn

The command selects the data source for the specified channel.

For the traffic channels, this value is specific for the selected radio configuration.

**Parameter:** **PNxx**  
PRBS data as per CCITT with period lengths between  $2^9-1$  and  $2^{23}-1$  is generated internally.

**DLISt**  
Internal data from a programmable data list is used. The data list can be generated by the Data Editor or generated externally. Data lists are selected in the **Select Data List** field. The data list is selected with the command  
BB:TDSC:DOWN:CELL1:ENH:BCH:DTCH:DATA:DSEL <data list name>

**ZERO | ONE**  
Internal 0 and 1 data is used.

**PATTErn**  
A user-definable bit pattern with a maximum length of 64 bits is generated internally. The bit pattern is defined in the **Pattern entry field**. The bit pattern is selected with the command  
BB:TDSC:DOWN:CELL1:ENH:BCH:DTCH:DATA:PATT <bit pattern>

**Example:** "BB:TDSC:DOWN:CELL1:ENH:BCH:DTCH:DATA PN9"  
'selects PN9 as the data source of the transport channel.'

*RST value	Resolution	Options	SCPI
PN9	-	B10/B11 and B13 K50 SOURce2 only with second option B9/B10/B11	Device-specific

**[SOURce<[1]>:]BB:TDSCdma:DOWN:CELL1:ENH:BCH:DTCH:DATA:DSElect <data list name>**

The command selects the data list for the DLIS data source selection.

The lists are stored as files with the fixed file extensions \*.dm\_iqd in a directory of the user's choice. The directory applicable to the following commands is defined with the command `MMEMoRY:CDIR`. To access the files in this directory, you only have to give the file name, without the path and the file extension.

For the traffic channels, this value is specific for the selected radio configuration.

**Example:**       `"SOUR:BB:TDSC:DOWN:CELL1:ENH:BCH:DTCH:DATA DLIS"`  
                  'selects the Data Lists data source for the transport channel.

`"MMEMoRY:CDIR 'D:\Lists\DM\IqData'"`  
                  'selects the directory for the data lists.

`"SOUR:BB:TDSC:DOWN:CELL1:ENH:BCH:DTCH:DATA:DSEL 'tdscdma_1'"`  
                  'selects file 'tdscdma\_1' as the data source. This file must be in the directory  
                  D:\Lists\DM\IqData and have the file extension \*.dm\_iqd.

*RST value	Resolution	Options	SCPI
-	-	B10/B11 and B13 K50 SOURce2 only with second option B9/B10/B11	Device-specific

**[SOURce<[1]>:]BB:TDSCdma:DOWN:CELL1:ENH:BCH:DTCH:DATA:PATtern**

`#B0,1 ... #B111..1,64:`

The command sets the bit pattern for the PATtern selection. The first parameter determines the bit pattern (choice of hexadecimal, octal, or binary notation). The second specifies the number of bits to use. The maximum length is 64 bits.

For the traffic channels, this value is specific for the selected radio configuration.

**Example:**       `"SOUR:BB:TDSC:DOWN:CELL1:ENH:BCH:DTCH:DATA:PATT`  
                  `#H800FE038,30"`  
                  'defines the bit pattern.

*RST value	Resolution	Options	SCPI
0	-	B10/B11 and B13 K50 SOURce2 only with second option B9/B10/B11	Device-specific

**[SOURce<[1]>:]BB:TDSCdma:DOWN:CELL1:ENH:BCH:DTCH:EPRotectioN?**

The command queries the error protection.

The command is a query command and therefore does not have an \*RST value.

**Example:**       `"BB:TDSC:DOWN:CELL1:ENH:BCH:DTCH:EPR?"`  
                  'queries the error protection.

*RST value	Resolution	Options	SCPI
-	-	B10/B11 and B13 K50 SOURce2 only with second option B9/B10/B11	Device-specific

[SOURce<[1]>:]BB:TDSCdma:DOWN:CELL1:ENH:BCH:DTCH:INTOne?

The command activates or deactivates the channel coding interleaver state 1 of the transport channel. Interleaver state 1 can be set independently in each TCH. Activation does not change the symbol rate.

**Example:** "BB:TDSC:DOWN:CELL1:ENH:BCH:DTCH:INTO ON"  
'activates the channel coding interleaver state 1 of the transport channel.

*RST value	Resolution	Options	SCPI
ON	-	B10/B11 and B13 K50 SOURce2 only with second option B9/B10/B11	Device-specific

[SOURce<[1]>:]BB:TDSCdma:DOWN:CELL1:ENH:BCH:DTCH:INTTwo?

The command activates or deactivates the channel coding interleaver state 2 off all the transport channels. Interleaver state 2 can only be set for all the TCHs together. Activation does not change the symbol rate.

**Example:** "BB:TDSC:DOWN:CELL1:ENH:BCH:DTCH:INTT ON"  
'activates the channel coding interleaver state 2 of all the transport channel.

*RST value	Resolution	Options	SCPI
ON	-	B10/B11 and B13 K50 SOURce2 only with second option B9/B10/B11	Device-specific

[SOURce<[1]>:]BB:TDSCdma:DOWN:CELL1:ENH:BCH:DTCH:RMATtribute?

The command queries the rate matching.

The command is a query command and therefore does not have an \*RST value.

**Example:** "BB:TDSC:DOWN:CELL1:ENH:BCH:DTCH:RMAT?"  
'queries the rate matching.

*RST value	Resolution	Options	SCPI
-	-	B10/B11 and B13 K50 SOURce2 only with second option B9/B10/B11	Device-specific

[SOURce<[1]>:]BB:TDSCdma:DOWN:CELL1:ENH:BCH:DTCH:STATE?

The command queries the state of the transport channel.

The command is a query command and therefore does not have an \*RST value.

**Example:** "BB:TDSC:DOWN:CELL1:ENH:BCH:DTCH:STAT?"  
'queries the state of the transpor channel.

*RST value	Resolution	Options	SCPI
-	-	B10/B11 and B13 K50 SOURce2 only with second option B9/B10/B11	Device-specific

**[SOURce<[1]>:]BB:TDSCdma:DOWN:CELL1:ENH:BCH:DTCH:TBCount?**

The command queries the number of transport blocks for the TCH.

The command is a query command and therefore does not have an \*RST value.

**Example:** "BB:TDSC:DOWN:CELL1:ENH:BCH:DTCH:TBC?"  
'queries the number of transport blocks for the TCH.

*RST value	Resolution	Options	SCPI
-	-	B10/B11 and B13 K50 SOURce2 only with second option B9/B10/B11	Device-specific

**[SOURce<[1]>:]BB:TDSCdma:DOWN:CELL1:ENH:BCH:DTCH:TBSize?**

The command queries the size of the transport block at the channel coding input.

The command is a query command and therefore does not have an \*RST value.

**Example:** "BB:TDSC:DOWN:CELL1:ENH:BCH:DTCH:TBS?"  
'queries the size of transport block of the channel coding input.

*RST value	Resolution	Options	SCPI
-	-	B10/B11 and B13 K50 SOURce2 only with second option B9/B10/B11	Device-specific

**[SOURce<[1]>:]BB:TDSCdma:DOWN:CELL1:ENH:BCH:DTCH:TTInterval?**

The command queries the number of frames into which a TCH is divided. This setting also defines the interleaver depth.

The command is a query command and therefore does not have an \*RST value.

**Example:** "BB:TDSC:DOWN:CELL1:ENH:BCH:DTCH:TTIN?"  
'queries the number of frames into which a TCH is divided.

*RST value	Resolution	Options	SCPI
-	-	B10/B11 and B13 K50 SOURce2 only with second option B9/B10/B11	Device-specific

**[SOURce<[1]>:]BB:TDSCdma:DOWN:CELL1:ENH:BCH:SCSMMode?**

The command queries the spreading code predetermined in the standard. For BCH, the spreading code is always **Auto**.

The command is a query command and therefore does not have an \*RST value.

**Example:** "BB:TDSC:DOWN:CELL1:ENH:BCH:SCSM?"  
'queries the spreading code.

*RST value	Resolution	Options	SCPI
-	-	B10/B11 and B13 K50 SOURce2 only with second option B9/B10/B11	Device-specific

**[SOURce<[1]|2>:]BB:TDSCdma:DOWN:CELL1:ENH:BCH:SFOR?**

The command queries the slot format of the selected channel. A slot format defines the complete structure of a slot made of data and control fields and includes the symbol rate. The slot format (and thus the symbol rate, the pilot length, and the TFCI State) depends on the coding type selected.

The command is a query command and therefore does not have an \*RST value.

**Example:** "BB:TDSC:DOWN:CELL1:ENH:BCH:SFOR?"  
'queries the channel coding type.

*RST value	Resolution	Options	SCPI
-	-	B10/B11 and B13 K50 SOURce2 only with second option B9/B10/B11	Device-specific

**[SOURce<[1]|2>:]BB:TDSCdma:DOWN:CELL1:ENH:BCH:SLOTstate<[0]...6>?**

The command queries the state of the slots off cell 1 used to transmit the broadcast channels. Slot 0 is always ON and all the other slots are always OFF.

The command is a query command and therefore does not have an \*RST value.

**Example:** "BB:TDSC:DOWN:CELL1:ENH:BCH:SLOT 0?"  
'queries the state of slot 1.

*RST value	Resolution	Options	SCPI
-	-	B10/B11 and B13 K50 SOURce2 only with second option B9/B10/B11	Device-specific

**[SOURce<[1]|2>:]BB:TDSCdma:DOWN:CELL1:ENH:BCH:STATE ON | OFF**

The command activates and deactivates the enhanced state for the P-CCPCH 1/2 channel. If the enhanced state is activated, the channel coding cannot be changed in the channel table.

**Example:** "BB:TDSC:DOWN:CELL1:ENH:BCH:STAT ON"  
'deactivates the enhanced state for the P-CCPCH 1/2 channel.

*RST value	Resolution	Options	SCPI
OFF	-	B10/B11 and B13 K50 SOURce2 only with second option B9/B10/B11	Device-specific



[SOURce<[1]|2>:]BB:TDSCdma:DOWN:CELL1:ENH:BCH:TYPE?

The command queries the channel coding type.

The command is a query command and therefore does not have an \*RST value.

**Example:** "BB:TDSC:DOWN:CELL1:ENH:BCH:TYPE?"  
'queries the channel coding type.

*RST value	Resolution	Options	SCPI
-	-	B10/B11 and B13 K50 SOURce2 only with second option B9/B10/B11	Device-specific

### SOURce:BB:TDSCdma – Channel Settings

Command	Parameter	Default Unit	Comments
[SOURce<[1] 2>:]BB:TDSCdma:DOWN   UP:CELL<[1] 2 3 4>:SLOT<[0]...6>:CHANnel<[0]...21>:DATA	PN9   PN11   PN15   PN16   PN20   PN21   PN23   DLISt   ZERO   ONE   PATTErn		
[SOURce<[1] 2>:]BB:TDSCdma:DOWN   UP:CELL<[1] 2 3 4>:SLOT<[0]...6>:CHANnel<[0]...21>:DATA:DSElect	<data list name>		
[SOURce<[1] 2>:]BB:TDSCdma:DOWN   UP:CELL<[1] 2 3 4>:SLOT<[0]...6>:CHANnel<[0]...21>:DATA:PATTErn	#B0,1...B11..1,64		
[SOURce<[1] 2>:]BB:TDSCdma:DOWN   UP:CELL<[1] 2 3 4>:SLOT<[0]...6>:CHANnel<[0]...21>:DCONFlict			Query only
[SOURce<[1] 2>:]BB:TDSCdma:DOWN   UP:CELL<[1] 2 3 4>:SLOT<[0]...6>:CHANnel<[0]...21>:DPCC:SYNC:LE Ngth	0   2   3   4   8   16   32   48		
[SOURce<[1] 2>:]BB:TDSCdma:DOWN   UP:CELL<[1] 2 3 4>:SLOT<[0]...6>:CHANnel<[0]...21>:DPCC:SYNC:PA TTern	<bit pattern>		
[SOURce<[1] 2>:]BB:TDSCdma:DOWN   UP:CELL<[1] 2 3 4>:SLOT<[0]...6>:CHANnel<[0]...21>:DPCC:SYNC:RE Petition	1...8		
[SOURce<[1] 2>:]BB:TDSCdma:DOWN   UP:CELL<[1] 2 3 4>:SLOT<[0]...6>:CHANnel<[0]...21>:DPCC:TFCI:LEN gth	0   2   4   6   8   12   16   24   32   48		
[SOURce<[1] 2>:]BB:TDSCdma:DOWN   UP:CELL<[1] 2 3 4>:SLOT<[0]...6>:CHANnel<[0]...21>:DPCC:TFCI:VAL ue	0...1023		
[SOURce<[1] 2>:]BB:TDSCdma:DOWN   UP:CELL<[1] 2 3 4>:SLOT<[0]...6>:CHANnel<[0]...21>:DPCC:TPC:DATA	ZERO   ONE   PATTErn   DLISt		
[SOURce<[1] 2>:]BB:TDSCdma:DOWN   UP:CELL<[1] 2 3 4>:SLOT<[0]...6>:CHANnel<[0]...21>:DPCC:TPC:DATA :DSElect	<data list name>		
[SOURce<[1] 2>:]BB:TDSCdma:DOWN   UP:CELL<[1] 2 3 4>:SLOT<[0]...6>:CHANnel<[0]...21>:DPCC:TPC:DATA :PATTErn	#B0,1...#B11...1, 64		
[SOURce<[1] 2>:]BB:TDSCdma:DOWN   UP:CELL<[1] 2 3 4>:SLOT<[0]...6>:CHANnel<[0]...21>:DPCC:TPC:REA D	CONTInuous   S0A   S1A   S01A   S10A		
[SOURce<[1] 2>:]BB:TDSCdma:DOWN   UP:CELL<[1] 2 3 4>:SLOT<[0]...6>:CHANnel<[0]...21>:ENHanced			Query only

Command	Parameter	Default Unit	Comments
[SOURce<[1]>:]BB:TDSCdma:DOWN   UP:CELL<[1]> 2 3 4>:SLOT<[0]...6>:CHANnel<[0]...21>:MSHift			Query only
[SOURce<[1]>:]BB:TDSCdma:DOWN   UP:CELL<[1]> 2 3 4>:SLOT<[0]...6>:CHANnel<[0]...21>:POWer	-80 dB...0 dB		
[SOURce<[1]>:]BB:TDSCdma:DOWN   UP:CELL<[1]> 2 3 4>:SLOT<[0]...6>:CHANnel<[0]...21>:SCODE	1...16		
[SOURce<[1]>:]BB:TDSCdma:DOWN   UP:CELL<[1]> 2 3 4>:SLOT<[0]...6>:CHANnel<[0]...21>:SFACtor	1   2   4   8   16		
[SOURce<[1]>:]BB:TDSCdma:DOWN   UP:CELL<[1]> 2 3 4>:SLOT<[0]...6>:CHANnel<[0]...21>:SFOR			Query only
[SOURce<[1]>:]BB:TDSCdma:DOWN   UP:CELL<[1]> 2 3 4>:SLOT<[0]...6>:CHANnel<[0]...21>:SFORmat	0...69		
[SOURce<[1]>:]BB:TDSCdma:DOWN   UP:CELL<[1]> 2 3 4>:SLOT<[0]...6>:CHANnel<[0]...21>:STATe	ON   OFF		
[SOURce<[1]>:]BB:TDSCdma:DOWN   UP:CELL<[1]> 2 3 4>:SLOT<[0]...6>:CHANnel<[0]...21>:TYPE	P_CCPCH1   P_CCPCH2   S_CCPCH1   S_CCPCH2   F_PACH   PD SCH   DPCH_QPSK   DPCH_8PSK   HS_SCCH1   HS_SCCH2   HS_PDS_QPSK   HS_PDS_16QAM   PUSCH   UP_DPCH_QPSK   UP_DPCH_8PSK   HS_SICH		
[SOURce<[1]>:]BB:TDSCdma:DOWN   UP:CELL<[1]> 2 3 4>:SLOT<[0]...6>:CHANnel<[0]...21>:USER	1...16		
[SOURce<[1]>:]BB:TDSCdma:UP:CELL<[1]> 2 3 4>:SLOT<[0]...6>:MODE	DEDicated   PRACH		
[SOURce<[1]>:]BB:TDSCdma:UP:CELL<[1]> 2 3 4>:SLOT<[0]...6>:PRAC:MSG:DATA	PN9   PN11   PN15   PN16   PN20   PN21   PN23   DLISt   ZERO   ONE   PATTErn		
[SOURce<[1]>:]BB:TDSCdma:UP:CELL<[1]> 2 3 4>:SLOT<[0]...6>:PRAC:MSG:DATA:DSElect	<data list name>		
[SOURce<[1]>:]BB:TDSCdma:UP:CELL<[1]> 2 3 4>:SLOT<[0]...6>:PRAC:MSG:DATA:PATTErn	#B0,1...B11..1,64		
[SOURce<[1]>:]BB:TDSCdma:UP:CELL<[1]> 2 3 4>:SLOT<[0]...6>:PRAC:MSG:LENgth	1   2   4		
[SOURce<[1]>:]BB:TDSCdma:UP:CELL<[1]> 2 3 4>:SLOT<[0]...6>:PRAC:MSG:MSHift			Query only
[SOURce<[1]>:]BB:TDSCdma:UP:CELL<[1]> 2 3 4>:SLOT<[0]...6>:PRAC:MSG:POWer	-80.0 dB...0.0 dB		
[SOURce<[1]>:]BB:TDSCdma:UP:CELL<[1]> 2 3 4>:SLOT<[0]...6>:PRAC:MSG:SCODE	1...16		
[SOURce<[1]>:]BB:TDSCdma:UP:CELL<[1]> 2 3 4>:SLOT<[0]...6>:PRAC:MSG:SFACtor	4   8   16		
[SOURce<[1]>:]BB:TDSCdma:UP:CELL<[1]> 2 3 4>:SLOT<[0]...6>:PRAC:MSG:SFORmat	0   10   25		
[SOURce<[1]>:]BB:TDSCdma:UP:CELL<[1]> 2 3 4>:SLOT<[0]...6>:PRAC:MSG:STATe	ON   OFF		
[SOURce<[1]>:]BB:TDSCdma:UP:CELL<[1]> 2 3 4>:SLOT<[0]...6>:PRAC:MSG:USER	1...16		

Command	Parameter	Default Unit	Comments
[SOURce<[1] 2>:]BB:TDSCdma:UP:CELL<[1] 2 3 4>:SLOT<[0]...6>:PRAC:PTS:DISTance	1...4		
[SOURce<[1] 2>:]BB:TDSCdma:UP:CELL<[1] 2 3 4>:SLOT<[0]...6>:PRAC:PTS:POWer	-80 dB...0 dB		
[SOURce<[1] 2>:]BB:TDSCdma:UP:CELL<[1] 2 3 4>:SLOT<[0]...6>:PRAC:PTS:PSTEp	0.0 dB...10.0 dB		
[SOURce<[1] 2>:]BB:TDSCdma:UP:CELL<[1] 2 3 4>:SLOT<[0]...6>:PRAC:PTS:REPetition	1...10 dB		
[SOURce<[1] 2>:]BB:TDSCdma:UP:CELL<[1] 2 3 4>:SLOT<[0]...6>:PRAC:PTS:STARt			

**[SOURce<[1]|2>:]BB:TDSCdma:DOWN | UP:CELL<[1]|2|3|4>:SLOT<[0]...6>:CHANnel<[0]...21>:DATA PN9 | PN11 | PN15 | PN16 | PN20 | PN21 | PN23 | DLISt | ZERO | ONE | PATTern**

The command determines the data source for the selected channel.

- Parameter: PNxx**  
PRBS data as per CCITT with period lengths between  $2^9-1$  and  $2^{23}-1$  is generated internally.
- DLISt**  
Internal data from a programmable data list is used.
- ZERO | ONE**  
Internal 0 and 1 data is used.
- PATTern**  
A user-definable bit pattern with a maximum length of 64 bits is generated internally.

**Example:** "BB:TDSC:DOWN:CELL4:SLOT3:CHAN6:DATA PN9"  
'sets the data source for the selected channel to PN9.

*RST value	Resolution	Options	SCPI
PN9	-	B10/B11 and B13 K50 SOURce2 only with second option B9/B10/B11	Device-specific

[SOURce<[1]|2>:]BB:TDSCdma:DOWN |  
 UP:CELL<[1]|2|3|4>:SLOT<[0]...6>:CHANnel<[0]...21>:DATA:DSElect <data list name>

The command selects the data list for the **Data List** data source selection of the selected channel.

The lists are stored as files with the fixed file extensions \*.dm\_iqd in a directory of the user's choice. The directory applicable to the following commands is defined with the command MMEMory:CDIR. To access the files in this directory, you only have to give the file name, without the path and the file extension.

**Example:** "SOUR:BB:TDSC:UP:CELL1:SLOT3:CHAN6:DATA: DLIS"  
 'selects the Data Lists data source.  
 "MMEM:CDIR 'D:\Lists\DM\IqData'"  
 'selects the directory for the data lists.  
 "SOUR:BB:TDSC:UP:CELL1:SLOT3:CHAN6:DATA:DSEL 'tdscdma\_1'"  
 'selects file 'tdscdma\_1' as the data source. This file must be in the directory D:\Lists\DM\IqData and have the file extension \*.dm\_iqd.

*RST value	Resolution	Options	SCPI
-	-	B10/B11 and B13 K50 SOURce2 only with second option B9/B10/B11	Device-specific

[SOURce<[1]|2>:]BB:TDSCdma:DOWN |  
 UP:CELL<[1]|2|3|4>:SLOT<[0]...6>:CHANnel<[0]...21>:DATA:PATTern #B0,1..B11..1,64

The command determines the bit pattern. The first parameter determines the bit pattern (choice of hexadecimal, octal, or binary notation), the second specifies the number of bits to use.

**Example:** "SOUR:BB:TDSC:UP:CELL1:SLOT3:CHAN6:DATA:PATT #H3F, 8"  
 'defines the bit pattern.

*RST value	Resolution	Options	SCPI
0	-	B10/B11 and B13 K50 SOURce2 only with second option B9/B10/B11	Device-specific

[SOURce<[1]|2>:]BB:TDSCdma:DOWN |  
 UP:CELL<[1]|2|3|4>:SLOT<[0]...6>:CHANnel<[0]...21>:DCONflict ?

The command queries whether the channel has a code domain conflict with one of the channels lying above it (with a lower channel number).

**Example:** "SOUR:BB:TDSC:UP:CELL1:SLOT3:CHAN6:DCON?"  
 'queries whether the channel has a code domain conflict.

*RST value	Resolution	Options	SCPI
-	-	B10/B11 and B13 K50 SOURce2 only with second option B9/B10/B11	Device-specific

[SOURce<[1]|2>:]BB:TDSCdma:DOWN |  
 UP:CELL<[1]|2|3|4>:SLOT<[0]...6>:CHANnel<[0]...21>:DPCC:SYNC:LENgth 0 | 2 | 3 | 4 | 8 | 16 | 32  
 | 48

The command sets the length of the Sync Shift and the length of the TPC field in bits. The available values depend on the slot format.

**Example:** "BB:TDSC:DOWN:CELL4:SLOT3:CHAN6:DPCC:SYNC:LEN 2"  
 'sets the Sync Shift and the length of the TPC field to 2 bits.

*RST value	Resolution	Options	SCPI
0	-	B10/B11 and B13 K50 SOURce2 only with second option B9/B10/B11	Device-specific

[SOURce<[1]|2>:]BB:TDSCdma:DOWN |  
 UP:CELL<[1]|2|3|4>:SLOT<[0]...6>:CHANnel<[0]...21>:DPCC:SYNC:PATtern <bit pattern>

The command sets the bit pattern for the sync shift. The maximum pattern length is 64 bits.

**Example:** "BB:TDSC:DOWN:CELL4:SLOT3:CHAN6:DPCC:SYNC:PATT 10-01"  
 'sets the bit pattern for the sync shift.

*RST value	Resolution	Options	SCPI
1	-	B10/B11 and B13 K50 SOURce2 only with second option B9/B10/B11	Device-specific

[SOURce<[1]|2>:]BB:TDSCdma:DOWN |  
 UP:CELL<[1]|2|3|4>:SLOT<[0]...6>:CHANnel<[0]...21>:DPCC:SYNC:REPetition 1...8

The command sets the value for the sync shift repetition. This value is used to define the time lag for which the sync shift is used to transmit a new time adjustment. Thereby, M specifies the time lag in subframes a 5 ms.

**Example:** "BB:TDSC:DOWN:CELL4:SLOT3:CHAN6:DPCC:SYNC:REP 1"  
 'sets the value for the sync shift repetition.

*RST value	Resolution	Options	SCPI
1	-	B10/B11 and B13 K50 SOURce2 only with second option B9/B10/B11	Device-specific

[SOURce<[1]|2>:]BB:TDSCdma:DOWN |  
 UP:CELL<[1]|2|3|4>:SLOT<[0]...6>:CHANnel<[0]...21>:DPCC:TFCI:LENgth 0 | 2 | 4 | 6 | 8 | 12 | 16 |  
 24 | 32 | 48

The command sets the length of the TFCI field in bits.

**Example:** "BB:TDSC:DOWN:CELL4:SLOT3:CHAN6:DPCC:TFCI:LEN 12"  
 'sets the length of the TFCI field to 12 bits.

*RST value	Resolution	Options	SCPI
0	-	B10/B11 and B13 K50 SOURce2 only with second option B9/B10/B11	Device-specific

[SOURce<[1]|2>:]BB:TDSCdma:DOWN |  
 UP:CELL<[1]|2|3|4>:SLOT<[0]...6>:CHANnel<[0]...21>:DPCC:TFCI:VALue 0...1023

The command sets the value of the TFCI field.

**Example:** "BB:TDSC:DOWN:CELL4:SLOT3:CHAN6:DPCC:TFCI:VAL 0"  
 'sets the value of the TFCI field to 0.

*RST value	Resolution	Options	SCPI
0	-	B10/B11 and B13 K50 SOURce2 only with second option B9/B10/B11	Device-specific

[SOURce<[1]|2>:]BB:TDSCdma:DOWN |  
 UP:CELL<[1]|2|3|4>:SLOT<[0]...6>:CHANnel<[0]...21>:DPCC:TPC:DATA ZERO | ONE | PATTern |  
 DLISt

The command sets the data source for the TPC field of the DPCCH.

**Parameter: DLISt**  
 A data list is used. The data list is selected with the command  
 SOUR:BB:TDSC:DOWN:CELL1:SLOT3:CHAN6:DPCC:TPC:DATA:DSEL

**ZERO | ONE**  
 Internal 0 and 1 data is used.

**PATTern**  
 Internal data is used. The bit pattern for the data is defined by the command  
 BB:TDSC:DOWN:CELL1:SLOT3:CHAN6:DPCC:TPC:DATA:PATT

**Example:** "BB:TDSC:DOWN:CELL4:SLOT3:CHAN6:DPCC:TPC:DATA PATT"  
 'selects as the data source for the TPC field of channel 6 of cell 4 the bit pattern defined with the following command.  
 "BB:TDSC:DOWN:CELL4:SLOT3:CHAN6:DPCC:TPC:DATA:PATT #H3F,8"  
 'defines the bit pattern.

*RST value	Resolution	Options	SCPI
PATT	-	B10/B11 and B13 K50 SOURce2 only with second option B9/B10/B11	Device-specific

[SOURce<[1]|2>:]BB:TDSCdma:DOWN |  
 UP:CELL<[1]|2|3|4>:SLOT<[0]...6>:CHANnel<[0]...21>:DPCC:TPC:DATA:DSElect <data list name>

The command selects the data list for the Data List TPC source selection.

The lists are stored as files with the fixed file extensions \*.dm\_iqd in a directory of the user's choice. The directory applicable to the following commands is defined with the command MMEMoRY:CDIR. To access the files in this directory, you only have to give the file name, without the path and the file extension.

For the traffic channels, this value is specific for the selected radio configuration.

**Example:** "SOUR:BB:TDSC:DOWN:CELL1:SLOT3:CHAN5:DPCC:TPC:DATA DLIS"  
 'selects the Data Lists data source.  
 "MMEM:CDIR 'D:\Lists\DM\IqData'"  
 'selects the directory for the data lists.  
 "SOUR:BB:TDSC:DOWN:CELL1:SLOT3:CHAN5:DPCC:TPC:DATA:DSEL  
 'tdscdma\_1'"  
 'selects file 'tdscdma\_1' as the data source. This file must be in the directory  
 D:\Lists\DM\IqData and have the file extension \*.dm\_iqd.

*RST value	Resolution	Options	SCPI
-	-	B10/B11 and B13 K50 SOURce2 only with second option B9/B10/B11	Device-specific

[SOURce<[1]|2>:]BB:TDSCdma:DOWN |  
 UP:CELL<[1]|2|3|4>:SLOT<[0]...6>:CHANnel<[0]...21>:DPCC:TPC:DATA:PATTern  
 #B0,1...#B111...1,64

The command sets the bit pattern. The maximum bit pattern length is 64 bits.

**Example:** "BB:TDSC:DOWN:CELL4:SLOT3:CHAN6:DPCC:TPC:DATA:PATT #H3F,8"  
 'defines the bit pattern.

*RST value	Resolution	Options	SCPI
01	-	B10/B11 and B13 K50 SOURce2 only with second option B9/B10/B11	Device-specific

[SOURce<[1]|2>:]BB:TDSCdma:DOWN |  
 UP:CELL<[1]|2|3|4>:SLOT<[0]...6>:CHANnel<[0]...21>:DPCC:TPC:READ CONTInuous | S0A | S1A  
 | S01A | S10A

The command sets the read out mode for the bit pattern of the TPC field.

**Parameter:** CONTInous

The TPC bits are used cyclically.

**S0A**

The TPC bits are used once and then the TPC sequence is continued with 0 bits.

**S1A**

The TPC bits are used once and then the TPC sequence is continued with 1 bit.

**S01A**

The TPC bits are used once and then the TPC sequence is continued with 0 and 1 bits alternately (in multiples, depending on by the symbol rate, for example, 00001111).

**S10A**

The TPC bits are used once, and then the TPC sequence is continued with 1 and 0 bits alternately (in multiples, depending on by the symbol rate, for example, 11110000).

**Example:**

"BB:TDSC:DOWN:CELL4:SLOT3:CHAN6:DPCC:TPC:READ S01A"

'the TPC bits are used once, and then the TPC sequence is continued with 0 and 1 bits alternately (in multiples, depending on by the symbol rate, for example, 00001111).

*RST value	Resolution	Options	SCPI
CONTInous	-	B10/B11 and B13 K50 SOURce2 only with second option B9/B10/B11	Device-specific

[SOURce<[1]|2>:]BB:TDSCdma:DOWN |  
 UP:CELL<[1]|2|3|4>:SLOT<[0]...6>:CHANnel<[0]...21>:ENHanced?

The command queries the enhanced state. If the enhanced state is set to ON, the channel coding cannot be changed.

The command is a query command and therefore does not have an \*RST value.

**Example:**

"BB:TDSC:DOWN:CELL4:SLOT3:CHAN6:ENH?"

'queries the enhanced state of channel 6.

*RST value	Resolution	Options	SCPI
-	-	B10/B11 and B13 K50 SOURce2 only with second option B9/B10/B11	Device-specific



[SOURce<[1]|2>:]BB:TDSCdma:DOWN |  
UP:CELL<[1]|2|3|4>:SLOT<[0]...6>:CHANnel<[0]...21>:MSHift?

The command queries the midamble shift.

The midamble can be shifted in a value range of 0 to 128 chips in increments of 8 chips. Channels belonging to the same mobile station are characterized by the same midamble shift.

The command is a query command and therefore does not have an \*RST value.

**Example:** "BB:TDSC:DOWN:CELL4:SLOT3:CHAN6:MSH?"  
'queries the midamble shift.

*RST value	Resolution	Options	SCPI
-	-	B10/B11 and B13 K50 SOURce2 only with second option B9/B10/B11	Device-specific

[SOURce<[1]|2>:]BB:TDSCdma:DOWN |  
UP:CELL<[1]|2|3|4>:SLOT<[0]...6>:CHANnel<[0]...21>:POWER -80 dB...0 dB

The command sets the channel power in dB.

**Example:** "BB:TDSC:DOWN:CELL4:SLOT3:CHAN6:POW -20"  
'set the channel power to -20 dB.

*RST value	Resolution	Options	SCPI
0	-	B10/B11 and B13 K50 SOURce2 only with second option B9/B10/B11	Device-specific

[SOURce<[1]|2>:]BB:TDSCdma:DOWN |  
UP:CELL<[1]|2|3|4>:SLOT<[0]...6>:CHANnel<[0]...21>:SCODE 1...16

The command sets the spreading code for the selected channel. The code channel is spread with the set spreading code. The range of values of the spreading code depends on the channel type and the spreading factor. Depending on the channel type, the range of values can be limited.

**Example:** "BB:TDSC:DOWN:CELL4:SLOT3:CHAN6:SCOD 1"  
'set the spreading code for channel 6 to 1.

*RST value	Resolution	Options	SCPI
1	-	B10/B11 and B13 K50 SOURce2 only with second option B9/B10/B11	Device-specific

[SOURce<[1]|2>:]BB:TDSCdma:DOWN |  
 UP:CELL<[1]|2|3|4>:SLOT<[0]...6>:CHANnel<[0]...21>:SFACtor 1 | 2 | 4 | 8 | 16

The command sets the spreading factor for the selected channel. The selection depends on the channel type and interacts with the slot format.

**Example:** "BB:TDSC:DOWN:CELL4:SLOT3:CHAN6:SFAC 16"  
 'sets the spreading factor for channel 6 to 16.

*RST value	Resolution	Options	SCPI
16	-	B10/B11 and B13 K50 SOURce2 only with second option B9/B10/B11	Device-specific

[SOURce<[1]|2>:]BB:TDSCdma:DOWN |  
 UP:CELL<[1]|2|3|4>:SLOT<[0]...6>:CHANnel<[0]...21>:SFOR?

The command queries the slot format of the selected channel. A slot format defines the complete structure of a slot made of data and control fields and includes the symbol rate. The slot format displays changes when a change is made to the **Number of TFCI Bits** and the **Number of Sync Shift & TPC Bits** field settings.

The command is a query command and therefore does not have an \*RST value.

**Example:** "BB:TDSC:DOWN:CELL4:SLOT3:CHAN6:SFOR?"  
 'queries the slot format of the selected channel.

*RST value	Resolution	Options	SCPI
-	-	B10/B11 and B13 K50 SOURce2 only with second option B9/B10/B11	Device-specific

[SOURce<[1]|2>:]BB:TDSCdma:DOWN |  
 UP:CELL<[1]|2|3|4>:SLOT<[0]...6>:CHANnel<[0]...21>:SFORmat 0...69

The command sets the slot format for the selected channel.

**Example:** "BB:TDSC:DOWN:CELL4:SLOT3:CHAN6:SFOR 0"  
 'sets the slot format for channel 6 to 0.

*RST value	Resolution	Options	SCPI
-	-	B10/B11 and B13 K50 SOURce2 only with second option B9/B10/B11	Device-specific

[SOURce<[1]|2>:]BB:TDSCdma:DOWN |  
UP:CELL<[1]|2|3|4>:SLOT<[0]...6>:CHANnel<[0]...21>:STATe ON | OFF

The command activates or deactivates the channel.

**Example:** "SOUR:BB:TDSC:UP:CELL1:SLOT3:CHAN6:STAT ON"  
'activates channel 6.

*RST value	Resolution	Options	SCPI
OFF	-	B10/B11 and B13 K50 SOURce2 only with second option B9/B10/B11	Device-specific

[SOURce<[1]|2>:]BB:TDSCdma:DOWN |  
UP:CELL<[1]|2|3|4>:SLOT<[0]...6>:CHANnel<[0]...21>:TYPE P\_CCPCH1 | P\_CCPCH2 |  
S\_CCPCH1 | S\_CCPCH2 | FPACH | PDSCH | DPCH\_QPSK | DPCH\_8PSK | HS\_SCCH1 |  
HS\_SCCH2 | HS\_PDS\_QPSK | HS\_PDS\_16QAM | PUSCH | UP\_DPCH\_QPSK | UP\_DPCH\_8PSK |  
HS\_SICH

The command sets the channel type.

In the uplink, the channel type is fixed for channel number 0. In the downlink, the channel type is fixed for channel numbers 0 to 5. For the remaining numbers, the choice lies between the relevant standard channels and the high speed channels.

**Example:** "BB:TDSC:DOWN:CELL4:SLOT3:CHAN6:TYPE DPC\_QPSK"  
'sets the channel type DPC\_QPSK for channel 6 of the channel table.

*RST value	Resolution	Options	SCPI
Depending on the channel number.	-	B10/B11 and B13 K50 / High Speed Channels: K51 SOURce2 only with second option B9/B10/B11	Device-specific

[SOURce<[1]|2>:]BB:TDSCdma:DOWN |  
UP:CELL<[1]|2|3|4>:SLOT<[0]...6>:CHANnel<[0]...21>:USER 1...16

The command sets the number of the user.

**Example:** "BB:TDSC:DOWN:CELL4:SLOT3:CHAN6:USER 3"  
'sets the number of the users to 3.

*RST value	Resolution	Options	SCPI
1	-	B10/B11 and B13 K50 SOURce2 only with second option B9/B10/B11	Device-specific

[SOURce<[1]|2>:]BB:TDSCdma:UP:CELL<[1]|2|3|4>:SLOT<[0]...6>:MODE DEDicated | PRACH

The command sets the mode in which the slot is to work.

**Parameter:**       **DEDicated**

The instrument generates a signal with a dedicated physical control channel (DPCCH) and up to 6 dedicated physical data channels (DPDCH). The signal is used for voice and data transmission.

**PRACH**

The instrument generates a single physical random access channel (PRACH). This channel is needed to set up the connection between the mobile station and the base station.

**Example:**       "BB:TDSC:UP:CELL4:SLOT3:MODE PRAC"  
                  'sets the PRACH mode for the selected slot.

*RST value	Resolution	Options	SCPI
DEDicated	-	B10/B11 and B13 K50 SOURce2 only with second option B9/B10/B11	Device-specific

[SOURce<[1]|2>:]BB:TDSCdma:UP:CELL<[1]|2|3|4>:SLOT<[0]...6>:PRAC:MSG:DATA PN9 | PN11 | PN15 | PN16 | PN20 | PN21 | PN23 | DLISt | ZERO | ONE | PATTErn

The command determines the data source for the PRACH.

**Parameter:**       **PNxx**

PRBS data as per CCITT with period lengths between  $2^9-1$  and  $2^{23}-1$  is generated internally.

**DLISt**

Internal data from a programmable data list is used.

**ZERO | ONE**

Internal 0 and 1 data is used.

**PATTErn**

A user-definable bit pattern with a maximum length of 64 bits is generated internally.

**Example:**       "BB:TDSC:DOWN:CELL4:SLOT3:PRAC:MSG:DATA PN9"  
                  'selects PN9 as the data source for the PRACH.

*RST value	Resolution	Options	SCPI
PN9	-	B10/B11 and B13 K50 SOURce2 only with second option B9/B10/B11	Device-specific

[SOURce<[1]|2>:]BB:TDSCdma:UP:CELL<[1]|2|3|4>:SLOT<[0]...6>:PRAC:MSG:DATA:DSElect <data list name>

The command selects the data list for the Data List data source selection.

The lists are stored as files with the fixed file extensions \*.dm\_iqd in a directory of the user's choice. The directory applicable to the following commands is defined with the command MMEMory:CDIR. To access the files in this directory, you only have to give the file name, without the path and the file extension.

**Example:** "SOUR:BB:TDSC:UP:CELL1:SLOT3:PRAC:MSG:DATA DLIS"  
 'selects the Data Lists data source.  
 "MMEM:CDIR 'D:\Lists\DM\IqData'"  
 'selects the directory for the data lists.  
 "SOUR:BB:TDSC:UP:CELL1:SLOT3:PRAC:MSG:DATA:DSEL 'tdscdma\_1'"  
 'selects file 'tdscdma\_1' as the data source. This file must be in the directory D:\Lists\DM\IqData and have the file extension \*.dm\_iqd.

*RST value	Resolution	Options	SCPI
-	-	B10/B11 and B13 K50 SOURce2 only with second option B9/B10/B11	Device-specific

[SOURce<[1]|2>:]BB:TDSCdma:UP:CELL<[1]|2|3|4>:SLOT<[0]...6>:PRAC:MSG:DATA:PATtern #B0,1...B11..1,64

The command determines the bit pattern. The first parameter determines the bit pattern (choice of hexadecimal, octal or binary notation), the second specifies the number of bits to use.

**Example:** "SOUR:BB:TDSC:UP:CELL1:SLOT3:PRAC:MSG:DATA:PATT #H3F, 8"  
 'defines the bit pattern.

*RST value	Resolution	Options	SCPI
-	-	B10/B11 and B13 K50 SOURce2 only with second option B9/B10/B11	Device-specific

[SOURce<[1]|2>:]BB:TDSCdma:UP:CELL<[1]|2|3|4>:SLOT<[0]...6>:PRAC:MSG:LENgth 1 | 2 | 4

The command sets the message length of the random access channel in subframes.

**Example:** "BB:TDSC:DOWN:CELL4:SLOT3:PRAC:MSG:LEN 1"  
 'sets the message length of the random access channel to 1 subframe.

*RST value	Resolution	Options	SCPI
1	-	B10/B11 and B13 K50 SOURce2 only with second option B9/B10/B11	Device-specific

[SOURce<[1]|2>:]BB:TDSCdma:UP:CELL<[1]|2|3|4>:SLOT<[0]...6>:PRAC:MSG:MSHift ?

The command queries the value of the midamble shift.

The command is a query command and therefore does not have an \*RST value.

**Example:** "SOUR:BB:TDSC:UP:CELL1:SLOT3:PRAC:MSG:MSH?"  
'queries the value of the midamble shift.

*RST value	Resolution	Options	SCPI
-	-	B10/B11 and B13 K50 SOURce2 only with second option B9/B10/B11	Device-specific

[SOURce<[1]|2>:]BB:TDSCdma:UP:CELL<[1]|2|3|4>:SLOT<[0]...6>:PRAC:MSG:POWER -80.0 dB...0.0 dB

The command sets the power of the PRACH message part.

**Example:** "BB:TDSC:DOWN:CELL4:SLOT3:PRAC:MSG:POW 1"  
'sets the power of the PRACH message part.

*RST value	Resolution	Options	SCPI
1	-	B10/B11 and B13 K50 SOURce2 only with second option B9/B10/B11	Device-specific

[SOURce<[1]|2>:]BB:TDSCdma:UP:CELL<[1]|2|3|4>:SLOT<[0]...6>:PRAC:MSG:SCODE 1...16

The command sets the spreading code for the PRACH. The code channel is spread with the set spreading code.

**Example:** "BB:TDSC:DOWN:CELL4:SLOT3:PRAC:MSG:SCOD 16"  
'sets the power of the PRACH message part.

*RST value	Resolution	Options	SCPI
0	-	B10/B11 and B13 K50 SOURce2 only with second option B9/B10/B11	Device-specific

[SOURce<[1]|2>:]BB:TDSCdma:UP:CELL<[1]|2|3|4>:SLOT<[0]...6>:PRAC:MSG:SFACtor 4 | 8 | 16

The command sets the spreading factor for the PRACH.

**Example:** "BB:TDSC:DOWN:CELL4:SLOT3:PRAC:MSG:SFAC 16"  
'sets the power of the PRACH message part.

*RST value	Resolution	Options	SCPI
16	-	B10/B11 and B13 K50 SOURce2 only with second option B9/B10/B11	Device-specific

[SOURce<[1]|2>:]BB:TDSCdma:UP:CELL<[1]|2|3|4>:SLOT<[0]...6>:PRAC:MSG:SFORmat ?

This command queries the slot format of the PRACH. The slot format depends on the selected spreading factor.

The command is a query command and therefore does not have an \*RST value.

**Example:** "BB:TDSC:DOWN:CELL4:SLOT3:PRAC:MSG:SFOR 1"  
'queries the slot format of the PRACH.

*RST value	Resolution	Options	SCPI
-	-	B10/B11 and B13 K50 SOURce2 only with second option B9/B10/B11	Device-specific

[SOURce<[1]|2>:]BB:TDSCdma:UP:CELL<[1]|2|3|4>:SLOT<[0]...6>:PRAC:MSG:STATE ON | OFF

The command activates or deactivates the RACH (random access channel) message part.

**Example:** "BB:TDSC:DOWN:CELL4:SLOT3:PRAC:MSG:STAT ON"  
'activates the RACH (random access channel) message part.

*RST value	Resolution	Options	SCPI
1	-	B10/B11 and B13 K50 SOURce2 only with second option B9/B10/B11	Device-specific

[SOURce<[1]|2>:]BB:TDSCdma:UP:CELL<[1]|2|3|4>:SLOT<[0]...6>:PRAC:MSG:USER 1...16

The command sets number of current user.

**Example:** "SOUR:BB:TDSC:UP:CELL1:SLOT3:PRAC:MSG:USER 1"  
'sets number of current user.

*RST value	Resolution	Options	SCPI
1	-	B10/B11 and B13 K50 SOURce2 only with second option B9/B10/B11	Device-specific

[SOURce<[1]|2>:]BB:TDSCdma:UP:CELL<[1]|2|3|4>:SLOT<[0]...6>:PRAC:PTS:DISTance 1...4

The command sets the value to vary the timing between UpPTS and RACH.

**Example:** "BB:TDSC:DOWN:CELL4:SLOT3:PRAC:PTS:DIST 1"  
 'sets the number of the subframe in which the first UpPTS should be transmitted.

*RST value	Resolution	Options	SCPI
1	-	B10/B11 and B13 K50 SOURce2 only with second option B9/B10/B11	Device-specific

[SOURce<[1]|2>:]BB:TDSCdma:UP:CELL<[1]|2|3|4>:SLOT<[0]...6>:PRAC:PTS:POWer -80 dB...0 dB

The command sets the power of the UpPTS.

**Example:** "BB:TDSC:DOWN:CELL4:SLOT3:PRAC:PTS:POW -12"  
 'sets the power of the UpPTS.

*RST value	Resolution	Options	SCPI
1	-	B10/B11 and B13 K50 SOURce2 only with second option B9/B10/B11	Device-specific

[SOURce<[1]|2>:]BB:TDSCdma:UP:CELL<[1]|2|3|4>:SLOT<[0]...6>:PRAC:PTS:PSTEp 0.0 dB...10.0 dB

The command sets the power by which the UpPTS is increased from repetition to repetition.

**Example:** "BB:TDSC:DOWN:CELL4:SLOT3:PRAC:PTS:PSTE 3"  
 'defines the power by which the UpPTS is increased from repetition to repetition.

*RST value	Resolution	Options	SCPI
0	-	B10/B11 and B13 K50 SOURce2 only with second option B9/B10/B11	Device-specific



[SOURce<[1]|2>:]BB:TDSCdma:UP:CELL<[1]|2|3|4>:SLOT<[0]...6>:PRAC:PTS:REPition 1...10 dB

The command sets the number of UpPTS repetitions before a PRACH burst happens.

**Example:** "BB:TDSC:DOWN:CELL4:SLOT3:PRAC:PTS:REP 1"  
 'sets the number of UpPTS repetitions before a PRACH burst happens.

*RST value	Resolution	Options	SCPI
1	-	B10/B11 and B13 K50 SOURce2 only with second option B9/B10/B11	Device-specific

[SOURce<[1]|2>:]BB:TDSCdma:UP:CELL<[1]|2|3|4>:SLOT<[0]...6>:PRAC:PTS:STARt 0.0 dB...10.0 dB

The command sets the number of the subframe in which the first UpPTS should be transmitted.

**Example:** "BB:TDSC:DOWN:CELL4:SLOT3:PRAC:PTS:STAR 3"  
 'sets the number of the subframe in which the first UpPTS should be transmitted.

*RST value	Resolution	Options	SCPI
0	-	B10/B11 and B13 K50 SOURce2 only with second option B9/B10/B11	Device-specific

# SOURce:BB:WiMax Subsystem

This subsystem contains commands for the primary and general settings of the IEEE 802.16 WiMAX standard. These settings concern activation and deactivation of the standard, setting the transmission direction, filter, clock, trigger and clipping settings, defining the frame duration and the sequence length, as well as the preset setting.

The commands for defining the frame configuration for physical layer modes OFDM and OFDMA are described in the next section. The commands are divided up in this way to make the comprehensive SOURce:BB:WiMax subsystem clearer.

The numerical suffix at SOURce distinguishes between path A and path B for two-path instruments:

SOURce<1> = path A

SOURce2 = path B

The keyword SOURce is optional with commands for path A and can be omitted. For path B, the command must include the keyword with the suffix 2.

Command	Parameters	Default unit	Comments
[SOURce<[1] 2>:]BB:WiMax:CLIPping:LEVel	1...100	PCT	
[SOURce<[1] 2>:]BB:WiMax:CLIPping:MODE	VECTor   SCALar		
[SOURce<[1] 2>:]BB:WiMax:CLIPping:STATe	ON   OFF		
[SOURce<[1] 2>:]BB:WiMax:CLOCK:MODE	SAMPle   MSAMPle		
[SOURce<[1] 2>:]BB:WiMax:CLOCK:MULTiplier	1... 64		
[SOURce<[1] 2>:]BB:WiMax:CLOCK:SOURce	EXTernal   INTernal		
[SOURce<[1] 2>:]BB:WiMax:DUPLexing	TDD   FDD		
[SOURce<[1] 2>:]BB:WiMax:FILTer:OPTimization	LEVm   LACP		
[SOURce<[1] 2>:]BB:WiMax:FILTer:PARAmeter:APCO25	0.05 ... 0.99		
[SOURce<[1] 2>:]BB:WiMax:FILTer:PARAmeter:COsine	0.05 ... 0.99		
[SOURce<[1] 2>:]BB:WiMax:FILTer:PARAmeter:COsine:COFS	-1.0 ... +1.0		
[SOURce<[1] 2>:]BB:WiMax:FILTer:PARAmeter:GAUSs	0.15 ... 2.5		
[SOURce<[1] 2>:]BB:WiMax:FILTer:PARAmeter:PGAuss	0.15 ... 2.5		
[SOURce<[1] 2>:]BB:WiMax:FILTer:PARAmeter:RCOSine	0.05 ... 0.99		
[SOURce<[1] 2>:]BB:WiMax:FILTer:PARAmeter:SPHase	0.15 ... 2.5		
[SOURce<[1] 2>:]BB:WiMax:FILTer:TYPE			Query only
[SOURce<[1] 2>:]BB:WiMax:FRAMe:BURSt:DELay	0.0 ms ... <frame duration>		
[SOURce<[1] 2>:]BB:WiMax:FRAMe:TIME	MS2   MS2D5   MS4   MS5   MS8   MS10   MS12D5   MS20   CONTInuous   USER		
[SOURce<[1] 2>:]BB:WiMax:FRAMe:TIME:USER	0 ... 10E6 s		
[SOURce<[1] 2>:]BB:WiMax:LINK	FORWard   REVerse (Alias DOWN   UP)		
[SOURce<[1] 2>:]BB:WiMax:MODE	OFDM   AOFDM   WIBRo		
[SOURce<[1] 2>:]BB:WiMax:PRESet			No query

Command	Parameters	Default unit	Comments
[SOURCE<[1]>:]BB:WIMax:SEQuence	AUTO   RETRigger   AAUTO   ARETrigger   SINGle		
[SOURCE<[1]>:]BB:WIMax:SETTing:CATalog?			Query only
[SOURCE<[1]>:]BB:WIMax:SETTing:DELeTe	<file_name>		
[SOURCE<[1]>:]BB:WIMax:SETTing:LOAD	<file_name>		
[SOURCE<[1]>:]BB:WIMax:SETTing:STORe	<file_name>		
[SOURCE<[1]>:]BB:WIMax:SLENgth	1 ... MAX		
[SOURCE<[1]>:]BB:WIMax:SRATe:VARiAtion	400 Hz ... 10 MHz	Hz (c/s)	
[SOURCE<[1]>:]BB:WIMax:STATe	ON   OFF		
[SOURCE<[1]>:]BB:WIMax:SUBFrame:TIME	0 ... MAX	s	
[SOURCE<[1]>:]BB:WIMax:TRIGger:ARM:EXECute			No query
[SOURCE<[1]>:]BB:WIMax:TRIGger:EXECute			No query
[SOURCE<[1]>:]BB:WIMax:TRIGger[:EXTeRnal<[1]>]:DELay	0 ... (2 <sup>32</sup> - 1) samples		
[SOURCE<[1]>:]BB:WIMax:TRIGger[:EXTeRnal<[1]>]:INHibit	0 ... (2 <sup>32</sup> - 1) samples		
[SOURCE<[1]>:]BB:WIMax:TRIGger:OBASeband:DELay	0 ... (2 <sup>32</sup> - 1) samples		
[SOURCE<[1]>:]BB:WIMax:TRIGger:OBASeband:INHibit	0 ... (2 <sup>32</sup> - 1) samples		
[SOURCE<[1]>:]BB:WIMax:TRIGger:OUTPut<[1]...4>:DELay	0 ... (2 <sup>32</sup> - 1) samples		
[SOURCE<[1]>:]BB:WIMax:TRIGger:OUTPut:DELay:FIXed	ON   OFF	Hz	
[SOURCE<[1]>:]BB:WIMax:TRIGger:OUTPut<[1]...4>:DELay:MAXimum			Query only
[SOURCE<[1]>:]BB:WIMax:TRIGger:OUTPut<[1]...4>:DELay:MINimum			Query only
[SOURCE<[1]>:]BB:WIMax:TRIGger:OUTPut<[1]...4>:FOFFset	-640000 ... 640000		
[SOURCE<[1]>:]BB:WIMax:TRIGger:OUTPut<[1]...4>:MODE	REStart   FRAMe   FACTive   PULSe   PATTern   RATio		
[SOURCE<[1]>:]BB:WIMax:TRIGger:OUTPut<[1]...4>:OFFTime	2 ... (2 <sup>24</sup> - 1) samples		
[SOURCE<[1]>:]BB:WIMax:TRIGger:OUTPut<[1]...4>:ONTIME	2 ... (2 <sup>24</sup> - 1) samples		
[SOURCE<[1]>:]BB:WIMax:TRIGger:OUTPut<[1]...4>:PATTern	#B0,1...#B111..1,32		
[SOURCE<[1]>:]BB:WIMax:TRIGger:OUTPut<[1]...4>:PULSe:DIVider	2 ... 1024		
[SOURCE<[1]>:]BB:WIMax:TRIGger:OUTPut<[1]...4>:PULSe:FREQUency			Query only
[SOURCE<[1]>:]BB:WIMax:TRIGger:OUTPut<[1]...4>:ROFFset	-640000 ... 640000		
[SOURCE<[1]>:]BB:WIMax:TRIGger:RMODE			Query only
[SOURCE<[1]>:]BB:WIMax:TRIGger:SLENgth	0 ... (2 <sup>32</sup> - 1) samples		
[SOURCE<[1]>:]BB:WIMax:TRIGger:SLUNit	FRAMe   CHIP   SEQuence		
[SOURCE<[1]>:]BB:WIMax:TRIGger:SOURce	EXTeRnal   INTeRnal   BEXTeRnal   OBASeband		
[SOURCE<[1]>:]BB:WIMax:WAVEform:CREate	<file_name>		
[SOURCE<[1]>:]BB:WIMax:VERSion			Query only

## SOURce-WIMax - Primary Commands

### [SOURce<[1]|2>:]BB:WIMax:CLIPping:LEVEl 0 ... 100 PCT

The command sets the limit for level clipping. This value indicates at what point the signal is clipped. It is specified as a percentage, relative to the highest level. 100% indicates that clipping does not take place.

Level clipping is activated with the command `SOUR:BB:WIM:CLIP:STAT ON`

**Example:**       `"BB:WIM:CLIP:LEV 80PCT"`  
                   'sets the limit for level clipping to 80% of the maximum level.

`"BB:WIM:CLIP:STAT ON"`  
                   'activates level clipping.

*RST value	Resolution	Options	SCPI
100 PCT	1	B10/B11 and B13 K49 SOURce2 only with second option B9/B10/B11	Device-specific

### [SOURce<[1]|2>:]BB:WIMax:CLIPping:MODE VECTor | SCALar

The command sets the method for level clipping (Clipping).

**Parameters:**   **VECTor**  
                   The reference level is the amplitude  $|i+jq|$

**SCALar**  
                   The reference level is the absolute maximum of the I and Q values.

**Example:**       `"BB:WIM:CLIP:MODE SCAL"`  
                   'selects the absolute maximum of all the I and Q values as the reference level.

`"BB:WIM:CLIP:LEV 80PCT"`  
                   'sets the limit for level clipping to 80% of this maximum level.

`"BB:WIM:CLIP:STAT ON"`  
                   'activates level clipping.

*RST value	Resolution	Options	SCPI
VECTor	-	B10/B11 and B13 K49 SOURce2 only with second option B9/B10/B11	Device-specific

[SOURce<[1]|2>:]BB:WIMax:CLIPping:STATe ON | OFF

The command activates level clipping (Clipping). The value is defined with the command [SOURce:]BB:WIMax:CLIPping:LEVel, the mode of calculation with the command [SOURce:]BB:WIMax:CLIPping:MODE .

**Example:** "BB:WIM:CLIP:STAT ON"  
'activates level clipping.

*RST value	Resolution	Options	SCPI
OFF		B10/B11 and B13 K49 SOURce2 only with second option B9/B10/B11	Device-specific

[SOURce<[1]|2>:]BB:WIMax:CLOCK:MODE SAMPlE | MSAMPlE

The command enters the type of externally supplied clock (:BB:WIMax:CLOCK:SOURce EXTErnal).

When MSAMPlE is used, a multiple of the sample clock is supplied via the CLOCK connector and the sample clock is derived internally from this. The multiplier is entered with the command :BB:WIMax:CLOCK:MUlTIplIEr. With this command the only numerical suffix allowed for SOURce is 1, since the external clock source is permanently allocated to path A.

**Example:** "BB:WIM:CLOC:MODE SAMP"  
'selects clock type **SAMPlE**, i.e. the supplied clock is a sample clock.

*RST value	Resolution	Options	SCPI
SAMPlE	-	B10/B11 and B13 K49 SOURce2 only with second option B9/B10/B11	Device-specific

[SOURce<[1]|2>:]BB:WIMax:CLOCK:MUlTIplIEr 1 ... 64

The command specifies the multiplier for clock type **MuTIplIEd** (:BB:WIMax:CLOCK:MODE MSAMPlE) in the case of an external clock source. With this command the only numerical suffix allowed for SOURce is 1, since the external clock source is permanently allocated to path A.

**Example:** "BB:WIM:CLOC:SOUR EXT"  
'selects the external clock source. The clock is supplied via the CLOCK connector.

"BB:WIM:CLOC:MODE MSAMP"  
'selects clock type **MuTIplIEd**, i.e. the supplied clock has a rate which is a multiple of the sample rate.

"BB:WIM:CLOC:MUlT 12"  
'the multiplier for the external clock rate is 12.

*RST value	Resolution	Options	SCPI
4	1	B10/B11 and B13 K49 SOURce2 only with second option B9/B10/B11	Device-specific

**[SOURce<[1]|2>:]BB:WIMax:CLOCK:SOURce INTernal | EXTernal**

The command selects the clock source. Selecting EXTernal is only possible for path A, since the external clock source is permanently allocated to path A.

**Parameter: INTernal**  
The internal clock reference is used.

**EXTernal**  
The external clock reference is supplied to the CLOCK connector.

**Example:** "BB:WIM:CLOC:SOUR EXT"  
'selects an external clock reference for path A. The clock is supplied via the CLOCK connector.

"BB:WIM:CLOC:MODE SAMP"  
'specifies that a sample clock is supplied via the CLOCK connector.

*RST value	Resolution	Options	SCPI
INTernal	-	B10/B11 and B13 K49 SOURce2 only with second option B9/B10/B11	Device-specific

**[SOURce<[1]|2>:]BB:WIMax:DUPLexing TDD | FDD**

The command selects the duplexing. The duplexing mode determines how the uplink and downlink signal are separated.

**Parameter: TDD**  
The same frequency is used for both directions of transmission (uplink and downlink). With one baseband, either downlink or uplink frames can be generated.

**FDD (OFDM only)**  
If only one link direction is considered at once, the IEEE 802.16 standard defines no differences between TDD and FDD signals on the physical layer. The FDD mode has been provided for convenience, it completely fills the defined frame with bursts to simulate a continuous transmission environment. It is recommended to use TDD mode instead if FDD decives are to be tested with frames including transmission gaps.

**Example:** "BB:WIM:DUPL FDD"  
'selects frequency division duplexing

*RST value	Resolution	Options	SCPI
TDD	-	B10/B11 and B13 K49 SOURce2 only with second option B9/B10/B11	Device-specific

[SOURce<[1]|2>:]BB:WIMax:FILTer:OPTimization LEVM | LACP

The command sets the filter optimization method.

**Parameter:**     **LEVM**  
                   The filter settings are selected so that the vector error (Error Vector Magnitude) is reduced.

**LACP**  
                   The filter settings are selected so that Adjacent Channel Power is improved.

**Example:**       BB:WIM:FILT:TYPE COS  
                   'selects filter type Cosine.  
                   BB:WIM:FILT:OPT LACP  
                   'selects filter settings for low ACP.

*RST value	Resolution	Options	SCPI
		B10/B11 and B13 K49 SOURce2 only with second option B9/B10/B11	Device-specific

[SOURce<[1]|2>:]BB:WIMax:FILTer:PARAmeter:APCO25 0.05 ... 0.99

The command sets the roll-off factor for the APCO25 filter type.

**Example:**       "BB:WIM:FILT:PAR:APCO25 0.04"  
                   "the roll-off factor is set to 0.04.

*RST value	Resolution	Options	SCPI
0.20		B10/B11 and B13 K49 SOURce2 only with second option B9/B10/B11	Device-specific

[SOURce<[1]|2>:]BB:WIMax:FILTer:PARAmeter:COSSine 0.05 ... 0.99

The command sets the roll-off factor for the Cosine filter type.

**Example:**       "BB:WIM:FILT:PAR:COS 0.04"  
                   "the roll-off factor is set to 0.04.

*RST value	Resolution	Options	SCPI
OFDM: 0.1 OFDMA: 0.1 (sampling frequency below 20 MHz) OFDMA: 0.07 (sampling frequency 20 MHz and above)		B10/B11 and B13 K49 SOURce2 only with second option B9/B10/B11	Device-specific

**[SOURce<[1]|2>:]BB:WIMax:FILTer:PARAmeter:COsine:COFS** -0.1 ... 1.0

The command sets the "cut of frequency shift" value for the Cosine filter type. The default value gets set when switching between OFDM and OFDMA.

**Example:** "BB:WIM:FILT:PAR:COS:COFS 0.04"  
 "the "cut of frequency shift" value is set to 0.04.

*RST value	Resolution	Options	SCPI
OFDM: -0.1 OFDMA: 0.0 (sampling frequency below 20 MHz) OFDMA:- 0.08 (sampling frequency 20 MHz and above)		B10/B11 and B13 K49 SOURce2 only with second option B9/B10/B11	Device-specific

**[SOURce<[1]|2>:]BB:WIMax:FILTer:PARAmeter:GAUSs** 0.15 ... 2.5

The command sets the BxT for the Gauss filter type (FSK).

**Example:** "BB:WIM:FILT:PAR:GAUS 0.5"  
 "the BxT is set to 0.5.

*RST value	Resolution	Options	SCPI
0.5		B10/B11 and B13 K49 SOURce2 only with second option B9/B10/B11	Device-specific

**[SOURce<[1]|2>:]BB:WIMax:FILTer:PARAmeter:PGAuss** 0.15 ... 2.5

The command sets the BxT for the Gauss filter type (pure).

**Example:** "BB:WIM:FILT:PAR:PGA 0.5"  
 "the BxT is set to 0.5.

*RST value	Resolution	Options	SCPI
0.5		B10/B11 and B13 K49 SOURce2 only with second option B9/B10/B11	Device-specific

**[SOURce<[1]|2>:]BB:WIMax:FILTer:PARAmeter:RCOSine** 0.05 ... 0.99

The command sets the roll-off factor for the Root Cosine filter type.

**Example:** "BB:WIM:FILT:PAR:RCOS 0.4"  
 "the roll-off factor is set to 0.4.

*RST value	Resolution	Options	SCPI
0.22		B10/B11 and B13 K49 SOURce2 only with second option B9/B10/B11	Device-specific



**[SOURce<[1]>:]BB:WIMax:FILTer:PARameter:SPHase 0.15...2.5**

The command sets the BxT for the Split Phase filter type.

**Example:** BB:WIM:FILT:PAR:SPH 2  
 "the BxT is set to 2.0.

*RST value	Resolution	Options	SCPI
2.00		B10/B11 and B13 K49 SOURce2 only with second option B9/B10/B11	Device-specific

**[SOURce<[1]>:]BB:WIMax:FILTer:TYPE RCOSine | COSine | GAUSs | LGAuss | CONE | COF705 | COEqualizer | COFequalizer | C2K3x | APCO25 | SPHase | RECTangle | PGAuss**

The command selects the baseband filter type.

**Example:** "BB:WIM:FILT:TYPE?"  
 'queries the baseband filter type.  
 Response: "COS"  
 'a cosine filter is used.

*RST value	Resolution	Options	SCPI
COSine		B10/B11 and B13 K42 SOURce2 only with second option B9/B10/B11	Device-specific

**[SOURce<[1]>:]BB:WIMax:FRAMe:BURSt:DELay 0.0 ms ... 4 294 967 295 000.0 s**

The command sets the delay for the first uplink burst.

The command is only available for physical layer mode OFDM in uplink and for FDD duplexing.

**Example:** "BB:WIM:MODE OFDM"  
 'selects physical layer mode OFDM.  
 "BB:WIM:LINK UP"  
 'selects transmission direction uplink.  
 "BB:WIM:DUP FDD"  
 'selects FDD duplexing.  
 "BB:WIM:FRAM:BURS:DEL 0.004"  
 'selects a delay of 4 ms for the first burst.

*RST value	Resolution	Options	SCPI
0	0.0 ms	B10/B11 and B13 K49 SOURce2 only with second option B9/B10/B11	Device-specific

**[SOURce<[1]>:]BB:WIMax:FRAMe:TIME** MS2 | MS2D5 | MS4 | MS5 | MS8 | MS10 | MS12D5 | MS20 | CONTInuous | USER

The command selects the frame duration. Only distinct values are allowed in the standard. For test reasons, continuous generation or generation for a freely selectable duration (USER) are available. The user duration is set with command SOUR:BB:WIM:FRAM:TIME:USER. In continuous mode, the frame duration equals the sum of the burst durations.

**Example:** "BB:WIM:FRAM:TIME MS12D5"  
'selects a frame length of 12.5 ms.

*RST value	Resolution	Options	SCPI
MS10	-	B10/B11 and B13 K49 SOURce2 only with second option B9/B10/B11	Device-specific

**[SOURce<[1]>:]BB:WIMax:FRAMe:TIME:USER** 0.000 ... 10E4 seconds

The command sets the frame duration to a freely selectable value.

**Example:** "BB:WIM:FRAM:TIME USER"  
'selects a user mode for frame length definition.  
"BB:WIM:FRAM:TIME:USER 1"  
'sets a frame length of 1 s.

*RST value	Resolution	Options	SCPI
0 ms	0 ms	B10/B11 and B13 K49 SOURce2 only with second option B9/B10/B11	Device-specific

**[SOURce<[1]>:]BB:WIMax:LINK** FORWard|DOWN | REVerse|UP

The command defines the transmission direction. The signal either corresponds to that of a base station (FORWard | DOWN) or that of a subscriber station (REVerse | UP).

**Example:** "BB:WIM:LINK DOWN"  
'the transmission direction selected is base station to subscriber station. The signal corresponds to that of a base station.

*RST value	Resolution	Options	SCPI
FORWard DOWN	-	B10/B11 and B13 K49 SOURce2 only with second option B9/B10/B11	Device-specific

[SOURce<[1]>:]BB:WIMax:MODE OFDM | AOFDm | WIBRo

The command selects the Physical Layer Mode.

**Parameter: OFDM**

The OFDM mode supports signal generation according to IEEE 802.16-2004 section 8.3 with a fixed FFT size of 256.

**AOFDm**

Orthogonal Frequency Division Multiple Access (OFDMA) groups multiple subcarriers of the OFDM into sub-channels. A single client or subscriber station might transmit using all of the sub-channels within the carrier space, or multiple clients might transmit with each using a portion of the total number of sub-channels simultaneously. OFDMA thus enables a more flexible use of resources. It can support nomadic and mobile operation.

**WIBRo**

The OFDMA – WiBro (Wireless Broadband) mode groups multiple subcarriers of the OFDM into sub-channels. A single client or subscriber station might transmit using all of the sub-channels within the carrier space, or multiple clients might transmit with each using a portion of the total number of sub-channels simultaneously. OFDMA thus enables a more flexible use of resources. It can support nomadic and mobile operation.

The OFDMA – WiBro mode is identical to the OFDMA mode. When selecting OFDMA – WiBro, these parameters are set to their WiBro defaults:

- Frame Duration: 5ms
- Frequency Band: WiBro
- Channel Bandwidth: 8.75 MHz
- Sampling Rate: 10 MHz
- Tg/Tb: 1/8
- FFT Size: 1024

**Example:** "BB:WIM:MODE OFDM"  
'selects physical layer mode OFDM

*RST value	Resolution	Options	Dependencies	SCPI
OFDM	-	B10/B11 and B13 K49 SOURce2 only with second option B9/B10/B11	Duplexing FDD is only possible for physical layer mode OFDM. Duplexing TDD is automatically set when switching to physical layer mode OFDMA.	Device-specific

[SOURce<[1]|2>:]BB:WIMax:PRESet

The command produces a standardized default for the IEEE 802.16 standard. The settings correspond to the \*RST values specified for the commands.

This command triggers an action and therefore has no \*RST value and no query form.

**Example:** "BB:WIM:PRES"  
'resets all the IEEE 802.16 settings to default values.

*RST value	Resolution	Options	Dependencies	SCPI
-	-	B10/B11 and B13 K49 SOURce2 only with second option B9/B10/B11	All IEEE 802.16 settings are preset. .	Device-specific

[SOURce<[1]|2>:]BB:WIMax:SEquence AUTO | RETRigger | AAUTo | ARETrigger | SINGLE

The command selects the trigger mode.

**Parameter:** **AUTO**  
The modulation signal is generated continuously.

**RETRigger**  
The modulation signal is generated continuously. A trigger event (internal or external) causes a restart.

**AAUTo**  
The modulation signal is generated only when a trigger event occurs. After the trigger event the signal is generated continuously. Signal generation is stopped with command SOUR:BB:WIM:TRIG:ARM:EXEC and started again when a trigger event occurs.

**ARETrigger**  
The modulation signal is generated only when a trigger event occurs. The device automatically toggles to RETRIG mode. Every subsequent trigger event causes a restart.  
Signal generation is stopped with command SOUR:BB:WIM:TRIG:ARM:EXEC and started again when a trigger event occurs.

**SINGLE**  
The modulation signal is generated only when a trigger event occurs. Then the signal is generated once to the length specified with command SOUR:BB:WIM:TRIG:SLen. Every subsequent trigger event causes a restart.

**Example:** "BB:WIM:SEQ AAUT"  
'sets the **Armed\_auto** trigger mode; the device waits for the first trigger (e.g. with \*TRG) and then generates the signal continuously.

*RST value	Resolution	Options	SCPI
AUTO	-	B10/B11 and B13 K49 SOURce2 only with second option B9/B10/B11	Device-specific

**[SOURce<[1]>:]BB:WiMax:SETTING:CATalog?**

This command reads out the files with IEEE 802.16 settings in the default directory. The default directory is set using command `MMEM:CDIRectory`. A path can also be specified, in which case the files in the specified directory are read. Only files with the file extension `*.wimax` will be listed.

The command is a query command and therefore has no `*RST` value.

**Example:** `"MMEM:CDIR 'D:\user\wimax"`  
`'sets the default directory to D:\user\wimax.`

`"BB:WIM:SETT:CAT?"`  
`'reads out all the files with IEEE 802.16 settings in the default directory.`

Response: `"'ofdm', 'fbpsk'"`  
`'the files 'ofdm' and 'fbpsk' are available.`

*RST value	Resolution	Options	SCPI
	-	B10/B11 and B13 K49 SOURce2 only with second option B9/B10/B11	Device-specific

**[SOURce<[1]>:]BB:WiMax:SETTING:DELeTe <file\_name>**

This command deletes the selected file with IEEE 802.16 WiMAX settings. The directory is set using command `MMEM:CDIRectory`. A path can also be specified, in which case the files in the specified directory are read. The file extension may be omitted. Only files with the file extension `*.wimax` will be deleted.

This command triggers an event and therefore has no `*RST` value and no query form.

**Example:** `"BB:WIM:SETT:DEL 'ofdm'"`  
`'deletes file 'ofdm'.`

*RST value	Resolution	Options	SCPI
	-	B10/B11 and B13 K49 SOURce2 only with second option B9/B10/B11	Device-specific

**[SOURce<[1]>:]BB:WiMax:SETTING:LOAD <file\_name>**

This command loads the selected file with IEEE 802.16 WiMAX settings. The directory is set using command `MMEM:CDIRectory`. A path can also be specified, in which case the files in the specified directory are read. The file extension may be omitted. Only files with the file extension `*.wimax` will be loaded.

This command triggers an event and therefore has no `*RST` value and no query form.

**Example:** `"BB:WIM:SETT:LOAD 'ofdm'"`  
`'loads file 'ofdm'.`

*RST value	Resolution	Options	SCPI
	-	B10/B11 and B13 K49 SOURce2 only with second option B9/B10/B11	Device-specific

**[SOURce<[1]2>:]BB:WIMax:SETTing:STORe <file\_name>**

This command stores the current IEE 802.16 WIMAX settings into the selected file. The directory is set using command `MMEM:CDIRectory`. A path can also be specified, in which case the files in the specified directory are read. Only the file name has to be entered. IEE 802.16 WIMAX settings are stored as files with the specific file extensions **\*.wimax**.

This command triggers an event and therefore has no \*RST value and no query form.

**Example:**           `"BB:WIM:SETT:STOR 'ofdm_tdd'"`  
                       'stores the current settings into file 'ofdm\_tdd'.

*RST value	Resolution	Options	SCPI
	-	B10/B11 and B13 K49 SOURce2 only with second option B9/B10/B11	Device-specific

**[SOURce<[1]2>:]BB:WIMax:SLENgth 1 ... max**

The command selects the number of frames. The maximum number of frames depends on the sampling rate, the set frame length (2 x sampling rate x frame length / command `BB:WIM:FRAM:TIM`) and the supplied ARB memory size (option B10 or B11).

**Example:**           `"BB:WIM:SLEN 4"`  
                       'selects the generation of 4 frames.

*RST value	Resolution	Options	SCPI
1	-	B10/B11 and B13 K49 SOURce2 only with second option B9/B10/B11	Device-specific

**[SOURce<[1]2>:]BB:WIMax:SRATe:VARiation 1 Mcps ... 40 Mcps**

The command enters the output sample rate.

A variation of this parameter only affects the ARB clock rate, all other signal parameters remain unchanged. If the sampling rate in the frame configuration menu is changed, this parameter is reset to the chosen sampling rate.

**Example:**           `"BB:WIM:SRAT:VAR 4000000"`  
                       'sets the output sample rate to 4 Mcps.

*RST value	Resolution	Options	SCPI
2 MHz	0.001 Hz	B10/B11 and B13 K49 SOURce2 only with second option B9/B10/B11	Device-specific

[SOURce<[1]>:]BB:WIMax:STATe ON | OFF

The command activates modulation in accordance with the IEE 802.16 WIMAX standard. Activating this standard deactivates all the other digital standards and digital modulation modes on the same path.

**Example:** "BB:WIM:STAT ON"  
'activates modulation in accordance with the IEE 802.16 WiMAX standard.

*RST value	Resolution	Options	Dependencies	SCPI
OFF	-	B10/B11 and B13 K49 SOURce2 only with second option B9/B10/B11	BB:WIM:STAT ON deactivates the other standards and digital modulation.	Device-specific

[SOURce<[1]>:]BB:WIMax:SUBFrame:TIME 0.0 ... MAX

The command set the duration of the downlink subframe.

The command is only available for uplink direction and when TDD is selected on the same path.

**Example:** "BB:WIM:LINK UP"  
'selects uplink transmission.  
"BB:WIM:DUPL TDD"  
'selects time division duplexing.  
"BB:WIM:SUBF:TIME 2ms"  
'sets a subframe duration of 1 ms.

*RST value	Resolution	Options	SCPI
0	1 ms	B10/B11 and B13 K49 SOURce2 only with second option B9/B10/B11	Device-specific

**[SOURce<[1]|2>:]BB:WIMax:TRIGger:ARM:EXECute**

The command stops signal generation for trigger modes Armed\_Auto and Armed\_Retrigger. A subsequent internal or external trigger event restart signal generation.

This command triggers an event and therefore has no \*RST value and no query form.

**Example:** "BB:WIM:TRIG:SOUR INT"  
 'sets internal triggering.

"BB:WIM:TRIG:SEQ ARET"  
 'sets Armed\_Retrigger mode, i.e. every trigger event causes signal generation to restart.

"BB:WIM:TRIG:EXEC"  
 'executes a trigger, signal generation is started.

"BB:WIM:TRIG:ARM:EXEC"  
 'signal generation is stopped.

"BB:WIM:TRIG:EXEC"  
 'executes a trigger, signal generation is started again.

*RST value	Resolution	Options	SCPI
		B10/B11 and B13 K49 SOURce2 only with second option B9/B10/B11	Device-specific

**[SOURce<[1]|2>:]BB:WIMax:TRIGger:EXECute**

The command executes a trigger. The internal trigger source must be selected using the command :BB:WIM:TRIG:SOUR INT and a trigger mode other than AUTO must be selected using the command :BB:WIM:TRIG:SEQ.

This command triggers an event and therefore has no \*RST value and no query form.

**Example:** "BB:WIM:TRIG:SOUR INT"  
 'sets internal triggering.

"BB:WIM:TRIG:SEQ RETR"  
 'sets Retrigger mode, i.e. every trigger event causes signal generation to restart.

"BB:WIM:TRIG:EXEC"  
 'executes a trigger.

*RST value	Resolution	Options	SCPI
		B10/B11 and B13 K49 SOURce2 only with second option B9/B10/B11	Device-specific



[SOURce<[1]|2>:]BB:WIMax:TRIGger[:EXtErnal<[1]|2>]:DELay 0 ... 2^32-1

The command specifies the trigger delay (expressed as a number of samples) for external triggering. The numeric suffix to EXtErnal distinguishes between the external trigger via the TRIGGER 1 (suffix 1) and TRIGGER 2 (suffix 2) connector.

**Example:** "BB:WIM:TRIG:SOUR EXT"  
 'sets an external trigger via the TRIGGER 1 connector.  
 "BB:WIM:TRIG:DEL 50"  
 'sets a delay of 50 samples for the trigger.

*RST value	Resolution	Options	SCPI
0 samples	1 sample	B10/B11 and B13 K49 SOURce2 only with second option B9/B10/B11	Device-specific

[SOURce<[1]|2>:]BB:WIMax:TRIGger[:EXtErnal<[1]|2>]:INHibit 0 ... 2^32-1

The command specifies the number of samples by which a restart is to be inhibited following a trigger event. This command applies only in the case of external triggering. The numeric suffix to EXtErnal distinguishes between the external trigger via the TRIGGER 1 (suffix 1) and TRIGGER 2 (suffix 2) connector.

**Example:** "BB:WIM:TRIG:SOUR EXT"  
 'selects an external trigger via the TRIGGER 1 connector  
 "BB:WIM:TRIG:INH 200"  
 'sets a restart inhibit for 200 samples following a trigger event.

*RST value	Resolution	Options	SCPI
0 samples	1 sample	B10/B11 and B13 K49 SOURce2 only with second option B9/B10/B11	Device-specific

[SOURce<[1]|2>:]BB:WIMax:TRIGger:OBASeband:DELay 0 ... 2^32-1

The command specifies the trigger delay (expressed as a number of samples) for triggering by the trigger signal from the second path (two-path instruments only).

**Example:** "BB:WIM:TRIG:SOUR OBAS"  
 'sets for path A the internal trigger executed by the trigger signal from the second path (path B).  
 "BB:WIM:TRIG:OBAS:DEL 50"  
 'sets a delay of 50 samples for the trigger.

RST value	Resolution	Options	SCPI
0 samples	1 samples	B10/B11 and B13 K49 Only with second option B13	Device-specific

[SOURce<[1]|2>:]BB:WIMax:TRIGger:OBASband:INHibit 0 ... 2<sup>32</sup>-1

The command specifies the number of samples by which a restart is to be inhibited following a trigger event. This command applies only for triggering by the second path (two-path instruments only).

**Example:** "BB:WIM:TRIG:SOUR OBAS"  
 'sets for path A the internal trigger executed by the trigger signal from the second path (path B).  
 "BB:WIM:TRIG:INH 200"  
 'sets a restart inhibit for 200 samples following a trigger event.

*RST value	Resolution	Options	SCPI
0 samples	1 sample	B10/B11 and B13 K49 Only with second option B13	Device-specific

[SOURce<[1]|2>:]BB:WIMax:TRIGger:OUTPut<[1]...4>:DELay 0 ... 2<sup>32</sup> - 1 Samples

The command defines the delay between the signal on the marker outputs and the start of the signal, expressed in terms of samples. Command :BB:WIMax:TRIGger:OUTPut:DELay:FIXed can be used to restrict the range of values to the dynamic range, i.e. the range within which a delay of the marker signals can be set without restarting the marker and signal.

**Example:** "BB:WIM:TRIG:OUTP2:DEL 1600"  
 'sets a delay of 1600 samples for the signal on connector MARKER 2.

*RST value	Resolution	Options	SCPI
0	1 sample	B10/B11 and B13 K49 SOURce2 only with second option B9/B10/B11	Device-specific

[SOURce<[1]|2>:]BB:WIMax:TRIGger:OUTPut:DELay:FIXed ON | OFF

The command restricts the marker delay setting range to the dynamic range. In this range the delay can be set without restarting the marker and signal. If a delay is entered in setting ON but is outside this range, the maximum possible delay is set and an error message is generated.

**Example:** "BB:WIM:TRIG:OUTP:DEL:FIX ON"  
 'restricts the marker signal delay setting range to the dynamic range.

*RST value	Resolution	Options	SCPI
OFF	-	B10/B11 and B13 K49 SOURce2 only with second option B9/B10/B11	Device-specific

**[SOURce<[1]|2>:]BB:WIMax:TRIGger:OUTPut<[1]...4>:DELay:MAXimum**

The command queries the maximum marker delay for setting :BB:WIMax:TRIG:OUTP:DEL:FIX ON.

The command is a query only and therefore has no \*RST value.

**Example:** "BB:WIM:TRIG:OUTP:DEL:FIX ON"  
'restricts the marker signal delay setting range to the dynamic range.

"BB:WIM:TRIG:OUTP:DEL:MAX"  
'queries the maximum of the dynamic range.

Response: "2000"  
'the maximum for the marker delay setting is 2000 samples.

*RST value	Resolution	Options	SCPI
-	-	B10/B11 and B13 K49 SOURce2 only with second option B9/B10/B11	Device-specific

**[SOURce<[1]|2>:]BB:WIMax:TRIGger:OUTPut<[1]...4>:DELay:MINimum**

The command queries the minimum marker delay for setting :BB:WIMax:TRIGger:OUTPut:DELay:FIXed ON.

The command is a query only and therefore has no \*RST value.

**Example:** "BB:WIM:TRIG:OUTP:DEL:FIX ON"  
'restricts the marker signal delay setting range to the dynamic range.

"BB:WIM:TRIG:OUTP:DEL:MIN"  
'queries the minimum of the dynamic range.

Response: "0"  
'the minimum for the marker delay setting is 0 samples.

*RST value	Resolution	Options	SCPI
-	-	B10/B11 and B13 K49 SOURce2 only with second option B9/B10/B11	Device-specific

**[SOURce<[1]|2>:]BB:WIMax:TRIGger:OUTPut<[1]...4>:FOFFset -640000...+640000 samples**

The command sets the fall offset for on/off ratio marker in number of samples.

**Example:** "BB:WIM:TRIG:OUTP2:FOFF 20"  
'sets a fall offsete of 20 samples for marker signal 2 on path A.

*RST value	Resolution	Options	SCPI
0	1	B10/B11 and B13 K49 SOURce2 only with second option B9/B10/B11	Device-specific

**[SOURce<[1]>:]BB:WIMax:TRIGger:OUTPut<[1]...4>:MODE**  
 REStart | FRAMe | FAcTive | PULSe | PATTern | RATio

The command defines the signal for the selected marker output.

- Parameter: REStart**  
 A marker signal is generated at the start of each sequence (the sequence length is set with command `SOUR:BB:WIM:FCOunt`).
- FRAMe**  
 A marker signal is generated at the start of each frame (the frame length is set with command `SOUR:BB:WIM:FRAM:TIME`).
- FAcTive**  
 The marker signal is high whenever a burst is active and low during inactive signal parts (such as the gaps between bursts in uplink mode or the uplink subframe in downlink TDD mode). This marker can be used to decrease the carrier leakage during inactive signal parts by feeding it into the pulse modulator.
- PATTern**  
 A marker signal is generated according to the user defined pattern (command `SOURce:BB:WIMax:TRIGger:OUTPut:PATTern`).
- RATio**  
 A marker signal corresponding to the Time Off / Time On specifications in the commands `SOURce:BB:WIMax:TRIGger:OUTPut:OFFT` and `SOURce:BB:WIMax:TRIGger:OUTPut:ONT` is generated.

**Example:** `"BB:WIM:TRIG:OUTP2:MODE FRAME"`  
 'selects the frame marker signal on output MARKER 2.

*RST value	Resolution	Options	SCPI
REStart	-	B10/B11 and B13 K49 SOURce2 only with second option B9/B10/B11	Device-specific

**[SOURce<[1]>:]BB:WIMax:TRIGger:OUTPut<[1]...4>:OFFTime** 1.. 2<sup>24</sup> - 1 (1..16 777 215) samples

The command sets the number of samples in a period (ON time + OFF time) during which the marker signal in setting `SOURce:BB:WIMax:TRIGger:OUTPut:MODE RATio` on the marker outputs is OFF.

**Example:** `"BB:WIM:TRIG:OUTP2:OFFT 200"`  
 'sets an OFF time of 200 samples for marker signal 2on path A.

*RST value	Resolution	Options	SCPI
1	1	B10/B11 and B13 K49 SOURce2 only with second option B9/B10/B11	Device-specific

[SOURce<[1]2>:]BB:WIMax:TRIGger:OUTPut<[1]...4>:ONTime 1.. 2<sup>24</sup> - 1 (1..16 777 215) samples

The command sets the number of samples in a period (ON time + OFF time) during which the marker signal in setting SOURce:BB:WIM:TRIGger:OUTPut:MODE RATio on the marker outputs is ON.

**Example:** "BB:WIM:TRIG:OUTP2:ONT 200"  
'sets an ON time of 200 samples for marker 2 on path A..

*RST value	Resolution	Options	SCPI
1	1	B10/B11 and B13 K49 SOURce2 only with second option B9/B10/B11	Device-specific

[SOURce<[1]2>:]BB:WIMax:TRIGger:OUTPut<[1]...4>:PATTern #B0,1 ... #B111...1, 2

The command defines the bit pattern used to generate the marker signal in the setting SOURce:BB:WIMax:TRIGger:OUTPut:MODE PATTern. 0 is marker off, 1 is marker on.

**Example:** "BB:WIM:TRIG:OUTP2:PATT #B000000011111111,15"  
'sets a bit pattern.  
"BB:WIM:TRIG:OUTP2:MODE PATT"  
'activates the marker signal according to a bit pattern on output MARKER 2.

*RST value	Resolution	Options	SCPI
#B,1	-	B10/B11 and B13 K49 SOURce2 only with second option B9/B10/B11	Device-specific

[SOURce<[1]2>:]BB:WIMax:TRIGger:OUTPut<[1]...4>:PULSe:DIVider 2 ... 2<sup>10</sup>

The command sets the divider for Pulse marker mode (SOUR:BB:WIM:TRIG:OUTP:MODE PULSe.). The resulting pulse frequency is derived by dividing the symbol rate by the divider.

**Example:** "BB:WIM:TRIG:OUTP2:PULS:DIV 2"  
'sets the divider to 2 for the path A marker signal on output MARKER 2.  
"BB:WIM:TRIG:OUTP2:FREQ?"  
'queries the resulting pulse frequency of the marker signal.  
Response: "66 000"  
'the resulting pulse frequency is 66 kHz.

*RST value	Resolution	Options	SCPI
2	1	B10/B11 and B13 K49 SOURce2 only with second option B9/B10/B11	Device-specific

**[SOURce<[1]|2>:]BB:WIMax:TRIGger:OUTPut<[1]...4>:PULSe:FREQUency?**

The command queries the pulse frequency of the pulsed marker signal in the setting SOURce:BB:WIMax:TRIGger:OUTPut:MODE PULSe. The pulse frequency is derived by dividing the symbol rate by the divider.

The command is a query command and therefore has no \*RST value.

**Example:** "BB:WIM:TRIG:OUTP2:PULS:DIV 2"  
 'sets the divider for the path A marker signal on output MARKER 2 to the value 2.

"BB:WIM:TRIG:OUTP2:MODE PULS"  
 'enables the pulsed marker signal.

"BB:WIM:TRIG:OUTP2:PULS:FREQ?"  
 'queries the pulse frequency of the marker signal.

Response: "33 000"  
 'the resulting pulse frequency is 33 kHz.

*RST value	Resolution	Options	SCPI
-	-	B10/B11 and B13 K49 SOURce2 only with second option B9/B10/B11	Device-specific

**[SOURce<[1]|2>:]BB:WIMax:TRIGger:OUTPut<[1]...4>:ROFFset -640000...+640000 samples**

The command sets the rise offset for on/off ratio marker in number of samples.

**Example:** "BB:WIM:TRIG:OUTP2:ROFF 20"  
 'sets a rise offsete of 20 samples for marker signal 2 on path A.

*RST value	Resolution	Options	SCPI
0	1	B10/B11 and B13 K49 SOURce2 only with second option B9/B10/B11	Device-specific

[SOURce<[1]|2>:]BB:WIMax:TRIGger:SOURce INTernal | EXTernal | BEXTernal | OBASeband

The command selects the trigger source.

**Parameter:**       **INTernal**  
 Triggering is executed by means of the Trigger command  
 SOURce<[1]|2>:BB:WIM:TRIGger:EXECute or \*TRG in the case of  
 remote control and by means of **Execute Trigger** in the case of manual  
 operation.

**EXTernal**  
 Triggering is executed by means of the signal on the TRIGGER 1 connector.

**BEXTernal**  
 Triggering is executed by means of the signal on the TRIGGER 2 connector.

**OBASeband**  
 Triggering is executed by means of the trigger signal from the second path  
 (two-path instruments only).

**Example:**       " SOUR2 : BB : WIM : TRIG : SOUR EXT "  
 'sets external triggering via the TRIGGER 1 connector for path B of a two-  
 path instrument.

*RST value	Resolution	Options	SCPI
INTernal	-	B10/B11 and B13 K49 SOURce2 only with second option B9/B10/B11	Device-specific

[SOURce<[1]|2>:]BB:WIMax:TRIGger:SLENgth 1 ... (2^32-1) samples

The command defines the length of the signal sequence to be output in the **Single** trigger mode  
 (SOUR:BB:WIMax:SEQ SING). The input is made in terms of samples.

It is possible to output deliberately just part of the frame, an exact sequence of the frame, or a  
 defined number of repetitions of the frame. The unit is defined with command  
 SOUR:BB:WIMax:TRIG:SLUNit.

**Example:**       " SOUR2 : BB : WIM : SEQ SING "  
 'sets trigger mode Single.  
 " SOUR2 : BB : WIM : TRIG : SLEN 200 "  
 'sets a sequence length of 200 samples. The first 200 samples of the current  
 frame will be output after the next trigger event.

*RST value	Resolution	Options	SCPI
32 768 samples	1 sample	B10/B11 and B13 K49 SOURce2 only with second option B9/B10/B11	Device-specific

[SOURce<[1]|2>:]BB:WiMax:TRIGger:SLUNit FRAME | CHIP | SEQUENCE

The command defines the unit for the entry of the length of the signal sequence (SOUR:BB:WiMax:TRIG:SLEN) to be output in the **Single** trigger mode (SOUR:BB:WiMax:SEQ SING).

**Parameter:**       **FRAME**

Unit Frame. A single frame is generated after a trigger event.

**CHIP**

Unit Chip. A single chip is generated after a trigger event.

**SEQUENCE**

Unit Sequence Length. A single sequence is generated after a trigger event.

**Example:**

"SOUR:BB:WIM:SEQ SING" 'sets trigger mode Single.

"SOUR:BB:WIM:TRIG:SLUN FRAM"  
'sets unit Frame length for the entry of sequence length.

"SOUR:BB:WIM:TRIG:SLEN 2"  
'sets a sequence length of 2 frame. Two frames will be output after the next trigger event.

*RST value	Resolution	Options	SCPI
SEQUENCE	-	B10/B11 and B13 K49 SOURce2 only with second option B9/B10/B11	Device-specific

[SOURce<[1]|2>:]BB:WiMax:WAVEform:CREate <file\_name>

This command creates a waveform using the current settings of the **WiMAX** menu. The file name is entered with the command. The file is stored with the predefined file extension \*.wv. The file name and the directory it is stored in are user-definable.

This command triggers an event and therefore has no \*RST value and no query form.

**Example:**

"MMEM:CDIR 'D:\user\waveform"  
'sets the default directory to D:\user\waveform.

"BB:WIM:WAV:CRE 'wimax\_1'"  
'creates the waveform file wimax\_1.wv in the default directory.

*RST value	Resolution	Options	SCPI
-	-	B10/B11 and B13 K42 SOURce2 only with second option B9/B10/B11	device-specific



**[SOURce:]BB:WiMax:VERSion?**

The command queries the version of the IEEE 802.16 WiMAX standard underlying the definitions. The command is a query command and therefore does not have an \*RST value.

**Example:** "BB:WIM:VERS?"  
'queries the IEEE 802.16 WiMAX version.

*RST value	Resolution	Options	SCPI
-	-	B10/B11 and B13 K42 SOURce2 only with second option B9/B10/B11	Device-specific

## SOURce-WiMax - OFDMA Physical Layer Settings

The SOURce:BB:WiMax:AOFDM systems contain commands for setting the characteristics of signals with OFDMA and OFDMA-WiBro physical layer.

The commands of this system only take effect if the OFDMA physical layer mode is selected:  
SOURce:BB:WiMax:MODE AOFDMa

or

SOURce:BB:WiMax:MODE WiBro

**Important:**

*In case of remote control, suffix counting for bursts corresponds to the suffix counting with WiMAX starting with burst 0. SCPI prescribes that suffix 1 is the default state and used when no specific suffix is specified. Therefore, burst 1 (and not burst 0) is selected when no suffix is specified.*

Command	Parameters	Default unit	Comments
[SOURce<[1] 2>:]BB:WiMax:AOFDM:BW	1.25E6 ... 28E6		
[SOURce<[1] 2>:]BB:WiMax:AOFDM:FBAND	ETSi   MMDS   WCS   USER   WiBro		
[SOURce<[1] 2>:]BB:WiMax:AOFDM:FFT	FFT128   FFT512   FFT1024   FFT2048		
[SOURce<[1] 2>:]BB:WiMax:AOFDM:IDCell	0.0 ...69.0		
[SOURce<[1] 2>:]BB:WiMax:AOFDM:N			Query only
[SOURce<[1] 2>:]BB:WiMax:AOFDM:POWER:REFERENCE	RMS   PREamble		
[SOURce<[1] 2>:]BB:WiMax:AOFDM:PREamble:INDEX	0 ... 113		
[SOURce<[1] 2>:]BB:WiMax:AOFDM:PREamble:INDEX:MODE	AUTO   USER		
[SOURce<[1] 2>:]BB:WiMax:AOFDM:SRATE	1.44E6 ... 32E6		
[SOURce<[1] 2>:]BB:WiMax:AOFDM:TGTB	1D4   1D8   1D16   1D32		
[SOURce<[1] 2>:]BB:WiMax::AOFDM[:ZONE<0...7>]:BURSt[:COUNT]	1...8		
[SOURce<[1] 2>:]BB:WiMax::AOFDM[:ZONE<0...7>]:BURSt<0...63>:CCODing:FE C	ON   OFF		
[SOURce<[1] 2>:]BB:WiMax::AOFDM[:ZONE<0...7>]:BURSt<0...63>:CCODing:INT erleaver	ON   OFF		

Command	Parameters	Default unit	Comments
[SOURce<[1] 2>:]BB:WiMax::AOFDM[:ZONE<0...7>]:BURSt<0...63>:CCODing:MODE	OFF   CC   CTC		
[SOURce<[1] 2>:]BB:WiMax::AOFDM[:ZONE<0...7>]:BURSt<0...63>:CCODing:RANDomizer	ON   OFF		
[SOURce<[1] 2>:]BB:WiMax::AOFDM[:ZONE<0...7>]:BURSt<0...63>:CCODing:REPCoding	REP0   REP2   REP4   REP6		
[SOURce<[1] 2>:]BB:WiMax::AOFDM[:ZONE<0...7>]:BURSt<0...63>:CONFLICT[:STATE]	ON   OFF		
[SOURce<[1] 2>:]BB:WiMax::AOFDM[:ZONE<0...7>]:BURSt<0...63>:DATA	PN9   PN15   PN16   PN20   PN21   PN23   ZERO   ONE   PATTErn   DLISt		
[SOURce<[1] 2>:]BB:WiMax::AOFDM[:ZONE<0...7>]:BURSt<0...63>:DATA:DSELe ct	<dlist_name>		
[SOURce<[1] 2>:]BB:WiMax::AOFDM[:ZONE<0...7>]:BURSt<0...63>:DATA:LENGt h	0 .. 10 000	byt es	
[SOURce<[1] 2>:]BB:WiMax::AOFDM[:ZONE<0...7>]:BURSt<0...63>:DATA:PATTErn	#B0,1...B11..1,64		
[SOURce<[1] 2>:]BB:WiMax::AOFDM[:ZONE<0...7>]:BURSt<0...63>:DIUC	0.0 ... 15.0		
[SOURce<[1] 2>:]BB:WiMax::AOFDM[:ZONE<0...7>]:BURSt<0...63>:FORMat	QPSK1D2   QPSK3D4   16QAM1D2   16QAM3D4   64QAM1D2   64QAM2D3   64QAM3D4		
[SOURce<[1] 2>:]BB:WiMax::AOFDM[:ZONE<0...7>]:BURSt<0...63>:MAC:CID	H0 ... HFFFF		
[SOURce<[1] 2>:]BB:WiMax::AOFDM[:ZONE<0...7>]:BURSt<0...63>:MAC:CRC:ST ATe	ON   OFF		
[SOURce<[1] 2>:]BB:WiMax::AOFDM[:ZONE<0...7>]:BURSt<0...63>:MAC:EKS	0 ... 4		
[SOURce<[1] 2>:]BB:WiMax::AOFDM[:ZONE<0...7>]:BURSt<0...63>:MAC:ENCRyp ted:STATE	ON   OFF		
[SOURce<[1] 2>:]BB:WiMax::AOFDM[:ZONE<0...7>]:BURSt<0...63>:MAC:STATE	ON   OFF		
[SOURce<[1] 2>:]BB:WiMax::AOFDM[:ZONE<0...7>]:BURSt<0...63>:MAC:TYPE	0 ... 0x40		
[SOURce<[1] 2>:]BB:WiMax::AOFDM[:ZONE<0...7>]:BURSt<0...63>:OFFSet:MOD E	USER   AUTO		
[SOURce<[1] 2>:]BB:WiMax::AOFDM[:ZONE<0...7>]:BURSt<0...63>:OFFSet:SUB Channel			
[SOURce<[1] 2>:]BB:WiMax::AOFDM[:ZONE<0...7>]:BURSt<0...63>:OFFSet:SYM Bol			
[SOURce<[1] 2>:]BB:WiMax::AOFDM[:ZONE<0...7>]:BURSt<0...63>:POWEr	-80 dB ... 0 dB	dB	
[SOURce<[1] 2>:]BB:WiMax::AOFDM[:ZONE<0...7>]:BURSt<0...63>:RANGing:AC ODe			Query only
[SOURce<[1] 2>:]BB:WiMax::AOFDM[:ZONE<0...7>]:BURSt<0...63>:RANGing:OP Portunity:SIZE	1...4		
[SOURce<[1] 2>:]BB:WiMax::AOFDM[:ZONE<0...7>]:BURSt<0...63>:RANGing:OP Portunity:SLOTcount	<number>		
[SOURce<[1] 2>:]BB:WiMax::AOFDM[:ZONE<0...7>]:BURSt<0...63>:RANGing:OP Portunity:SCGCount	1...10		
[SOURce<[1] 2>:]BB:WiMax::AOFDM[:ZONE<0...7>]:BURSt<0...63>:SLOT:COUNT	0 ...		
[SOURce<[1] 2>:]BB:WiMax::AOFDM[:ZONE<0...7>]:BURSt<0...63>:SUBChannel: COUNT			
[SOURce<[1] 2>:]BB:WiMax::AOFDM[:ZONE<0...7>]:BURSt<0...63>:SYMBOL[:COU Nt]	0 ... MAX		

Command	Parameters	Default unit	Comments
[SOURCE<[1]>:]BB:WiMax::AOFDM[:ZONE<0...7>]:BURSt<0...63>:TYPE	DATA   FCH   DLMap   DATA   RANGing		
[SOURCE<[1]>:]BB:WiMax::AOFDM[:ZONE<0...7>]:BURSt<0...63>:UIUC	0.0 ... 15.0		
[SOURCE<[1]>:]BB:WiMax::AOFDM[:ZONE<0...7>]:BURSt<0...63>:ULMap:AMODe	DLSFend   FRAMestart		
[SOURCE<[1]>:]BB:WiMax::AOFDM[:ZONE<0...7>]:BURSt<0...63>:ULMap:ATIME	0 ... frame duration		
[SOURCE<HW>:]BB:WiMax:AOFDM:ZONE:COUNT	0 ... 7		
[SOURCE<[1]>:]BB:WiMax::AOFDM[:ZONE<0...7>]:DLMap:BSID	#H0,0...#H23222222FF,48		
[SOURCE<[1]>:]BB:WiMax::AOFDM[:ZONE<0...7>]:DLMap:DATA:DCD[:COUNT]	0 .255		
[SOURCE<[1]>:]BB:WiMax::AOFDM[:ZONE<0...7>]:DLMap:FNOFFset	0 ... 16777215		
[SOURCE<[1]>:]BB:WiMax::AOFDM[:ZONE<0...7>]:DLMap:MODE	AUTO   USER		
[SOURCE<[1]>:]BB:WiMax::AOFDM[:ZONE<0...7>]:DLMap:REPCoding	RC0   RC2   RC4   RC6		
[SOURCE<[1]>:]BB:WiMax:AOFDM:ZONE<0...7>:FCH:MODE	AUTO   USER		
[SOURCE<[1]>:]BB:WiMax:AOFDM:ZONE<0...7>:NUMBER	0 ... 7		
[SOURCE<[1]>:]BB:WiMax:AOFDM:ZONE<0...7>:PERMbase	0 ... 127		
[SOURCE<[1]>:]BB:WiMax:AOFDM:ZONE<0...7>:PRBSid	0 ... 3		
[SOURCE<[1]>:]BB:WiMax::AOFDM[:ZONE<0...7>]:TYPE	FUSC   PUSC		
[SOURCE<[1]>:]BB:WiMax::AOFDM[:ZONE<0...7>]:SCARrier:RANDOMizer	ON   OFF		
[SOURCE<[1]>:]BB:WiMax:AOFDM:ZONE<0...7>:SEGMENT	0 ... 2		
[SOURCE<[1]>:]BB:WiMax:AOFDM:ZONE<0...7>:STC:ANTenna	ANT0   ANT1		
[SOURCE<[1]>:]BB:WiMax:AOFDM:ZONE<0...7>:STC:MODE	OFF   MA2antenna   MB2antenna		
[SOURCE<[1]>:]BB:WiMax::AOFDM[:ZONE<0...7>]:SUBChannel:MODE	ALL   USER		
[SOURCE<[1]>:]BB:WiMax::AOFDM[:ZONE<0...7>]:SUBChannel:PATTERN	#B0,1...B11..1,72		
[SOURCE<[1]>:]BB:WiMax::AOFDM[:ZONE<0...7>]:SUBChannel<0...5>:MAP	ON   OFF		
[SOURCE<[1]>:]BB:WiMax:AOFDM:ZONE<0...7>:SYMBOL:COUNT	<number>		
[SOURCE<[1]>:]BB:WiMax:AOFDM:ZONE<0...7>:SYMBOL:COUNT:AUTO			
[SOURCE<[1]>:]BB:WiMax:AOFDM:ZONE<0...7>:SYMBOL:OFFSet			Query only
[SOURCE<[1]>:]BB:WiMax::AOFDM[:ZONE<0...7>]:TYPE	FUSC   PUSC		
[SOURCE<[1]>:]BB:WiMax::AOFDM[:ZONE<0...7>]:UCD	0 ... 255		
[SOURCE<[1]>:]BB:WiMax::AOFDM[:ZONE<0...7>]:ULMap:CREate	<file_name>		

**[SOURce<[1]2>:]BB:WIMax:AOFDm:BW 1.25 to 28 MHz.**

The command sets the channel bandwidth. The selected channel bandwidth has to be a multiple of 1.25, 1.5, 1.75, 2.0 or 2.75 MHz. The channel bandwidth determines the parameter n (sampling ratio, command SOUR:BB:WIMax:AOFD:N).

The sampling rate is derived from the channel bandwidth as follows:

$$\text{SamplingRate} = \text{floor}(n * \text{ChannelBandwidth} / 8000) * 8000$$

**Downlink:** The allowed values depend on the selected frequency band (command SOUR:BB:WIMax:AOFD:FBAN). Only discrete sets of values are available. If a new value is not allowed, the next allowed value in the direction of change is set.

**Uplink:** The full range between 1.25 and 28 MHz is available. Only discrete sets of values are available. If a new value is not allowed, the next allowed value in the direction of change is set.

**Example:** 14 MHz and 28 MHz are allowed, the current value is 14 MHz. If a new value of 15 MHz is entered it is changed to 28 MHz.

**Example:** "BB:WIM:AOFD:FBAN ETSI"  
'selects frequency band according to ETSI specifications.

"BB:WIM:AOFD:BW 7E6"  
'sets the channel bandwidth to 7 MHz.

*RST value	Resolution	Options	SCPI
1.75 MHz	-	B10/B11 and B13, K49 SOURce2 only with second option B9/B10/B11	Device-specific

[SOURce<[1]>:]BB:WIMax:AOFDm:FBANd ETSI | MMDS | WCS | UNII | USER | WIBRo

The command selects the available frequency band for the carrier frequencies.

**Parameter:**

**ETSI**

The frequency band as defined by the **European Telecommunications Standards Institute** applies. The range is 1.75 to 28 MHz for the channel bandwidth and 2 to 32 MHz for the sampling rate.

**MMDS**

The frequency band as defined by the **Multichannel Multipoint Distribution Service** applies. The RF frequency range is 2500 to 2686 MHz. The range is 1.50 to 24 MHz for the channel bandwidth and 1.72 to 27.52 MHz for the sampling rate.

**WCS**

The frequency band as defined by the **Wireless Communication Service** applies. It is in the 2.3 GHz band of the electromagnetic spectrum from 2305 to 2320 MHz and 2345 to 2360 MHz. The range is 2.5 to 15 MHz for the channel bandwidth and 2.88 to 17.28 MHz for the sampling rate.

**UNII**

The frequency band as defined by the **Unlicensed National Information Infrastructure** applies. It is in the 5 GHz band of the electromagnetic spectrum from 5150 to 5350 GHz and 5750 to 5825 GHz. The range is 10 to 20 MHz for the channel bandwidth and 11.52 to 23.04 MHz for the sampling rate.

**USER**

This mode is provided for choosing any other channel bandwidth / sampling rate combination. The range is 1.25 to 28 MHz for the channel bandwidth and 1.44 to 32 MHz for the sampling rate.

**WIBRo**

The frequency band as defined by the **Telecommunications Technology Association of Korea**. It is in the 2.3 GHz band of the electromagnetic spectrum.

**Example:**

"BB:WIM:AOFD:FBAN ETSI"  
'selects frequency band according to ETSI specifications.

*RST value	Resolution	Options	SCPI
ETSI	-	B10/B11 and B13 K49 SOURce2 only with second option B9/B10/B11	Device-specific

[SOURce<[1]>:]BB:WiMax:AOFDM:FFT FFT128 | FFT512 | FFT1024 | FFT2048

The command sets the size of the fast fourier transform. For OFDM channels, the size is fixed to 256. For OFDMA configuration, the possible configurations of the subchannel map depend on the selected FFT size.

**Example:** "BB:WIM:AOFD:FFT?"  
'queries the FFT size.

Response: "FFT256"  
'the FFT size is 256.

*RST value	Resolution	Options	SCPI
FFT2048	-	B10/B11 and B13 K49 SOURce2 only with second option B9/B10/B11	Device-specific

[SOURce<[1]>:]BB:WiMax:AOFDM:IDCell 0 ... 31

Sets the IDcell. The IDcell is used in the preamble, as PermBase parameter for the permutation equations in the first downlink zone and partly sets the subcarrier randomizer initialisation vector in the first downlink zone. The uplink alias command is SOURce:BB:WiMax:AOFDM:ULID1.

**Example:** "BB:WIM:AOFD:IDC 4"  
'sets ID cell 4.

*RST value	Resolution	Options	SCPI
0	-	B10/B11 and B13 K49 SOURce2 only with second option B9/B10/B11	Device-specific

[SOURce<[1]>:]BB:WiMax:AOFDM:N

The command queries the factor n (sampling ratio). The sampling ratio is determined by the channel bandwidth (see parameter **Channel Bandwidth**).

The command is a query and therefore does not have an \*RST value.

**Example:** "BB:WIM:AOFD:N?"  
'queries the factor n.

Response: "N8D7"  
'the factor n is 8/7.

*RST value	Resolution	Options	SCPI
-	-	B10/B11 and B13 K49 SOURce2 only with second option B9/B10/B11	Device-specific

[SOURce<[1]>:]BB:WIMax:AOFDm:POWER:REFerence RMS | PREamble

The command selects the level reference.

**Parameter:** RMS

The instrument's level setting refers to the mean power of the subframe.

**PREamble**

The instrument's level setting refers to the preamble, which is FCH / Burst power + 3dB (downlink only).

**Example:**

```
"BB:WIM:MODE AOFD"
'selects physical layer mode OFDMA.

"BB:WIM:LINK DOWN"
'select transmission direction downlink.

"BB:WIM:AOFD:POW:REF PRE"
'the instrument's level setting refers to the preamble.
```

*RST value	Resolution	Options	SCPI
PREamble	-	B10/B11 and B13 K49 SOURce2 only with second option B9/B10/B11	Device-specific

[SOURce<[1]>:]BB:WIMax:AOFDm:PREamble:INDex 0 ... 113

The command selects the preamble index for the generation of a downlink frame preamble.

This command is available only in downlink and in **User** mode (SOURce:BB:WIMax:AOFD:PRE:IND:MODE USER).

**Example:**

```
"BB:WIM:LINK DOWN"
'selects downlink transmission.

"BB:WIM:AOFD:PRE:IND 10"
'selects preamble 10.
```

*RST value	Resolution	Options	SCPI
0		B10/B11 and B13 K49 SOURce2 only with second option B9/B10/B11	Device-specific

[SOURce<[1]|2>:]BB:WIMax:AOFDm:PREamble:INDEX:MODE AUTO | USER

The command selects the mode for selecting the preamble index.

This command is available only in downlink and in **User** mode (SOURce:BB:WIMax:AOFD:PRE:IND:MODE USER).

**Example:** "BB:WIM:LINK DOWN"  
'selects downlink transmission.

"BB:WIM:AOFD:PRE:IND:MODE AUTO"  
'the preamble index for the generation of a downlink frame preamble is set automatically.

*RST value	Resolution	Options	SCPI
AUTO		B10/B11 and B13 K49 SOURce2 only with second option B9/B10/B11	Device-specific

[SOURce<[1]|2>:]BB:WIMax:AOFDm:SRATe1.44 MHz ... 32 MHz

The command sets the sampling rate. The sampling rate is related to the channel bandwidth by the parameter n:

$$\text{SamplingRate} = \text{floor}(n * \text{ChannelBandwidth} / 8000) * 8000$$

**Downlink:**

The value range depends on the selected frequency band (command SOUR:BB:WIMax:AOFD:FBAN). Only discrete sets of values are available. If a new value is not allowed, the next allowed value in the direction of change is set.

**Uplink:**

The full range between 1.44 and 32 MHz is available. Only discrete sets of values are available. If a new value is not allowed, the next allowed value in the direction of change is set.

**Example:** 16 MHz and 32 MHz are allowed, the current value is 16 MHz. If a new value of 17 MHz is entered it is changed to 32 MHz.

**Example:** "BB:WIM:AOFD:SRAT 2E6"  
'sets a sampling rate of 2 MHz.

*RST value	Resolution	Options	SCPI
2 MHz	1 kHz	B10/B11 and B13 K49 SOURce2 only with second option B9/B10/B11	Device-specific



[SOURce<[1]>:]BB:WIMax:AOFDm:TGTB TGTB1D4 | TGTB1D8 | TGTB1D16 | TGTB1D32

The command selects the ratio of guard period to symbol period. This value sets the length of the cyclic prefix in fractions of the symbol period.

**Example:** "BB:WIM:AOFD:TGTB TGTB1D8"  
'sets a ratio of 1 to 8.

*RST value	Resolution	Options	SCPI
1D4	-	B10/B11 and B13 K49 SOURce2 only with second option B9/B10/B11	Device-specific

[SOURce<[1]>:]BB:WIMax:AOFDm[:ZONE<0...7>]:BURSt[:COUNT ] 1 ... 8

The command sets the number of active bursts in the zone/segment).

**Example:** "BB:WIM:AOFD:ZONE0:BURS2:COUN 2"  
'two bursts are sent in one frame.

*RST value	Resolution	Options	SCPI
1	-	B10/B11 and B13 K49 SOURce2 only with second option B9/B10/B11	Device-specific

[SOURce<[1]>:]BB:WIMax:AOFDm[:ZONE<0...7>]:BURSt<0...63>:CCODing:FEC ON | OFF

The command switches channel coding FEC parameter on or off.

**Example:** "BB:WIM:AOFD:ZONE0:BURS:CCOD:FEC ON"  
'activates channel coding FEC parameter for burst 1.

*RST value	Resolution	Options	SCPI
ON	-	B10/B11 and B13 K49 SOURce2 only with second option B9/B10/B11	Device-specific

[SOURce<[1]>:]BB:WIMax:AOFDm[:ZONE<0...7>]:BURSt<0...63>:CCODing:INTerleaver ON | OFF

The command switches channel coding interleaver on or off.

**Example:** "BB:WIM:AOFD:ZONE0:BURS:CCOD:INT ON"  
'activates channel coding interleaver for burst 1.

*RST value	Resolution	Options	SCPI
ON	-	B10/B11 and B13 K49 SOURce2 only with second option B9/B10/B11	Device-specific

[SOURce<[1]2>:]BB:WiMax:AOFDm[:ZONE<0...7>]:BURSt<0...63>:CCODing:MODE OFF | CC | CTC

The command activates/deactivates channel coding and selects channel coding mode. If channel coding is switched off, the bits read from the data source are directly modulated onto the carriers. Due to randomization missing, this could result in very high crest factors of the signal.

**Example:** "BB:WIM:AOFD:ZONE0:BURS2:CCOD:MODE OFF"  
'deactivates channel coding for burst 1.

*RST value	Resolution	Options	SCPI
ON	-	B10/B11 and B13 K49 SOURce2 only with second option B9/B10/B11	Device-specific

[SOURce<[1]2>:]BB:WiMax:AOFDm[:ZONE<0...7>]:BURSt<0...63>:CCODing:RANDomizer ON | OFF

The command switches channel coding randomizer on or off.

**Example:** "BB:WIM:AOFD:ZONE:BURS:CCOD:RAND ON"  
'activates channel coding randomizer for burst 1.

*RST value	Resolution	Options	SCPI
ON	-	B10/B11 and B13 K49 SOURce2 only with second option B9/B10/B11	Device-specific

[SOURce<[1]2>:]BB:WiMax:AOFDm[:ZONE<0...7>]:BURSt<0...63>:CCODing:REPCoding REP0 | REP2 | REP4 | REP6

The command selects the channel coding repetition coding.

**Example:** "BB:WIM:AOFD:ZONE0:BURS:CCOD:REPC REP0"  
'deactivates repetition coding.

*RST value	Resolution	Options	SCPI
0	-	B10/B11 and B13 K49 SOURce2 only with second option B9/B10/B11	Device-specific

**[SOURce<[1]|2>:]BB:WIMax:AOFDm:ZONE<0...7>:BURSt<0...63>:CONFLict[:STATe]**

The command indicates a conflict between two bursts.

Conflicts can occur if subchannel and symbol offsets are set manually and two or more bursts overlap. Bursts can also overlap with the FCH or DL-MAP. The position of FCH and DL-MAP is fixed and cannot be changed.

The command is a query and therefore does not have an \*RST value.

**Example:** "BB:WIM:AOFD:ZONE0:BURS2:CONF?"  
 'queries if there exist a conflict between the activated OFDMA bursts.

Response: "0"  
 'there exists not conflict between the activated OFDMA bursts.

*RST value	Resolution	Options	SCPI
-	-	B10/B11 and B13 K49 SOURce2 only with second option B9/B10/B11	Device-specific

**[SOURce<[1]|2>:]BB:WIMax:AOFDm[:ZONE<0...7>]:BURSt<0...63>:DATA  
 PN9 | PN15 | PN16 | PN20 | PN21 | PN23 | DLISt | ZERO | ONE | PATTern**

The command determines the data source for the specified bursts.

**Parameters:** **PNxx**  
 The pseudo-random sequence generator is used as the data source. Different random sequence lengths can be selected.

**DLISt**  
 A data list is used. The data list is selected with the command  
 :BB:WIMax:AOFD:BURS:DATA:DSElect.

**ZERO | ONE**  
 Internal 0 and 1 data is used

**PATTern**  
 Internal data is used The bit pattern for the data is defined by the command  
 :BB:WIMax:AOFD:BURS:DATA:PATTern.

**Example:** "BB:WIM:AOFD:ZONE:BURS:DATA PATT"  
 'selects as the data source for the data fields of burst 1, the bit pattern defined with the following command.

"BB:WIM:AOFD:BURS:DATA:PATT #H3F,8"  
 'defines the bit pattern.

*RST value	Resolution	Options	SCPI
PN9	-	B10/B11 and B13 K49 SOURce2 only with second option B9/B10/B11	Device-specific

[SOURce<[1]|2>:]BB:WiMax:AOFDM[:ZONE<0...7>]:BURSt<0...63>:DATA:DSElect <data list name>

The command selects the data list for the DLIS data source selection.

The lists are stored as files with the fixed file extensions \*.dm\_iqd in a directory of the user's choice. The directory applicable to the following commands is defined with the command MMEMoRY:CDIR. To access the files in this directory, you only have to give the file name, without the path and the file extension.

**Example:** "BB:WIM:AOFD:ZONE0:BURS:DATA DLIS"  
 'selects the Data Lists data source.  
 "MME:CDIR 'D:\Lists\DM\IqData'"  
 'selects the directory for the data lists.  
 "BB:WIM:AOFD:ZONE:BURS:DATA:DLIS 'wimax\_list1'"  
 'selects file 'wimax\_list1' as the data source. This file must be in the directory D:\Lists\DM\IqData and have the file extension \*.dm\_iqd.

*RST value	Resolution	Options	SCPI
-	-	B10/B11 and B13 K49 SOURce2 only with second option B9/B10/B11	Device-specific

[SOURce<[1]|2>:]BB:WiMax:AOFDM[:ZONE<0...7>]:BURSt<0...63>:DATA:LENGth 0 ... 10 000 Bytes

The command sets the data length in bytes. The given number of bytes is read from the data source. The total number of data bytes in the burst (before channel coding) is determined as follows:

$$\text{TotalDataBytes} = \text{DataLength} + \text{MACHeaderBytes} + \text{CRCBytes} + \text{TailByte}$$

The tail byte is only added when channel coding is switched on. The same is the case for the MAC header and CRC, they are not added when switched off. Additionally padding with 0xFF bytes is applied at the end of the data sequence to reach an integer number of OFDM symbols.

The data length determines the number of symbols and vice versa. The maximum data length of 10000 bytes defines the maximum number of symbols for a given modulation type and channel coding rate.

**Example:** "BB:WIM:AOFD:ZONE0:BURS:DATA:LEN 256"  
 'sets a data length of 256.

*RST value	Resolution	Options	SCPI
100	-	B10/B11 and B13 K49 SOURce2 only with second option B9/B10/B11	Device-specific

[SOURce<[1]|2>:]BB:WIMax:AOFDm[:ZONE<0...7>]:BURSt<0...63>:DATA:PATtern #B0,1...  
#B111..1,64

The command determines the bit pattern for the PATtern selection. The maximum length is 64 bits.

**Example:** "BB:WIM:AOFD:ZONE0:BURS:DATA:PATT #H3F,8"  
'defines the bit pattern.

*RST value	Resolution	Options	SCPI
0	-	B10/B11 and B13 K49 SOURce2 only with second option B9/B10/B11	Device-specific

[SOURce<[1]|2>:]BB:WIMax:AOFDm[:ZONE<0...7>]:BURSt<0...63>:DIUC 0 ... 15

The command sets the specific interval usage code. The code is used to initialize the randomizer and is transmitted in the FCH

**Example:** "BB:WIM:AOFD:ZONE:BURS2:DIUC 12"  
'sets Interval Usage Code12 for burst 2.

*RST value	Resolution	Options	SCPI
1		B10/B11 and B13 K49 SOURce2 only with second option B9/B10/B11	Device-specific

[SOURce<[1]|2>:]BB:WIMax:AOFDm[:ZONE<0...7>]:BURSt<0...63>:FORMat QPSK1D2 |  
QPSK3D4 | 16QAM1D2 | 16QAM3D4 | 64QAM1D2 | 64QAM2D3 | 64QAM3D4

Selects the modulation and channel coding rate. Channel coding includes randomization, reed solomoon coding, convontional coding and interleaving.

For a given modulation type and channel coding rate, the data length determines the number of symbols and vice versa.

**Example:** "BB:WIM:AOFD:ZONE0:BURS:FORM 64QAM3D4"  
'selects modulation type 64QAM and a channel coding rate of 3.4 Msamples for burst 1.

*RST value	Resolution	Options	SCPI
BPSK1D2	-	B10/B11 and B13 K49 SOURce2 only with second option B9/B10/B11	Device-specific

[SOURce<[1]>:]BB:WiMax:AOFDm[:ZONE<0...7>]:BURSt<0...63>:MAC:CID #H0...#HFFFF

The command sets the CID (connection control identifier) of the medium access control layer (MAC). The CID identifies a connection to equivalent peers in the MAC of the base station and subscriber station.

**Example:** "BB:WIM:AOFD:ZONE0:BURS2:MAC:CID #HE7"  
'sets the CID for burst 2 to 231.

*RST value	Resolution	Options	SCPI
0	-	B10/B11 and B13 K49 SOURce2 only with second option B9/B10/B11	Device-specific

[SOURce<[1]>:]BB:WiMax:AOFDm:BURSt<0...7>:MAC:CRC:STATe ON | OFF

The command activates/deactivates the checksum determination. The state of the CRC can be set independently of the state of MAC header generation.

**Example:** "BB:WIM:AOFD:BURS2:MAC:CRC:STAT ON"  
'activates the checksum determination for burst 2.

*RST value	Resolution	Options	SCPI
OFF	-	B10/B11 and B13 K49 SOURce2 only with second option B9/B10/B11	Device-specific

[SOURce<[1]>:]BB:WiMax:AOFDm:BURSt<0...7>:MAC:EKS 0 ... 4

The command sets the EKS (encryption key sequence) value in the MAC header. The payload encryption itself is not performed by the signal generator.

**Example:** "BB:WIM:AOFD:BURS2:MAC:ENCR:STAT ON"  
'enables payload encryption  
"BB:WIM:AOFD:BURS2:MAC:EKS 2"  
'sets the EKS for burst 2.

*RST value	Resolution	Options	SCPI
0		B10/B11 and B13 K49 SOURce2 only with second option B9/B10/B11	Device-specific

**[SOURce<[1]]2>:]BB:WiMax:AOFDm:BURSt<0...7>:MAC:ENCRypted:STATe ON | OFF**

The command activates/disactivates payload encryption. If activated, the EC (encryption control) field is set to 1 and the EKS (encryption key sequence) field can be set.

**Example:** "BB:WIM:AOFD:BURS2:MAC:ENCR:STAT ON"  
 'enables payload encryption for burst 2.  
 "BB:WIM:AOFD:BURS2:MAC:EKS 2"  
 'sets the EKS.

*RST value	Resolution	Options	SCPI
OFF		B10/B11 and B13 K49 SOURce2 only with second option B9/B10/B11	Device-specific

**[SOURce<[1]]2>:]BB:WiMax:AOFDm:BURSt<0...7>:MAC:STATe ON | OFF**

The command enables/disables generation of the generic MAC header for the selected burst.

**Example:** "BB:WIM:AOFD:BURS2:MAC:STAT ON"  
 'enables generation of the generic MAC header for burst 2.

*RST value	Resolution	Options	SCPI
OFF		B10/B11 and B13 K49 SOURce2 only with second option B9/B10/B11	Device-specific

**[SOURce<[1]]2>:]BB:WiMax:AOFDm:BURSt<0...7>:MAC:TYPE #H0,0...#H40,6**

The command specifies the MAC type..The value of the 6-bit type field is set which indicates the payload type, including the presence of subheaders.

**Example:** "BB:WIM:AOFD:BURS2:MAC:TYPE #H3F"  
 'sets the type field of the MAC header of burst 2.

*RST value	Resolution	Options	SCPI
#H0		B10/B11 and B13 K49 SOURce2 only with second option B9/B10/B11	Device-specific

[SOURce<[1]>:]BB:WIMax:AOFDm[:ZONE<0...7>]:BURSt<0...63>:OFFSet:MODE USER | AUTO

The command selects the offset mode for the selected burst. The offset mode determines if the subchannel offset and the symbol offset of each burst are set automatically or manually.

**Example:** "BB:WIM:AOFD:ZONE0:BURS2:OFFS:MODE USER"  
 'sets the manual offset mode. The start subchannel and symbol of the burst are set manually with commands  
 BB:WIM:ZONE0:AOFD:BURS2:OFFS:SUBChannel and  
 BB:WIM:AOFD:ZONE0:BURS2:OFFS:SYMBOL.

*RST value	Resolution	Options	SCPI
AUTO		B10/B11 and B13 K49 SOURce2 only with second option B9/B10/B11	Device-specific

[SOURce<[1]>:]BB:WIMax:AOFDm[:ZONE<0...7>]:BURSt<0...63>:OFFSet:SUBChannel 0 ... 4  
 294 967 295

The command sets the subchannel offset for the selected burst. BB:WIM:AOFD:ZONE0:BURS2:OFFS:MODE USER

**Example:** "BB:WIM:AOFD:ZONE0:BURS2:OFFS:MODE USER"  
 'sets the manual offset mode.  
 "BB:WIM:AOFD:ZONE0:BURS2:OFFS:SUBC 8"  
 'selects subchannel 8 as start subchannel for burst 2.

*RST value	Resolution	Options	SCPI
Burst0: 7 All other bursts: 0		B10/B11 and B13 K49 SOURce2 only with second option B9/B10/B11	Device-specific

[SOURce<[1]>:]BB:WIMax:AOFDm[:ZONE<0...7>]:BURSt<0...63>:OFFSet:SYMBOL 3 ... 1000

The command sets the symbol offset for the selected burst. BB:WIM:AOFD:ZONE0:BURS2:OFFS:MODE USER

**Example:** "BB:WIM:AOFD:ZONE0:BURS2:OFFS:MODE USER"  
 'sets the manual offset mode.  
 "BB:WIM:AOFD:ZONE0:BURS2:OFFS:SYMB 2"  
 'selects symbol 2 as start symbol for burst 2.

*RST value	Resolution	Options	SCPI
0		B10/B11 and B13 K49 SOURce2 only with second option B9/B10/B11	Device-specific



[SOURce<[1]>:]BB:WIMax:AOFDM[:ZONE<0...7>]:BURSt<0...63>:POWer -80 dB ... +10 dB

The command sets the power for the selected burst in dB. To set the absolute power of a burst correctly, level reference **FCH / Burst** must be selected. In this mode, the output power of a burst equals Level + BurstPower.

**Example:** "BB:WIM:AOFDM:ZONE0:BURS2:POW -2 dB"  
'sets the burst power to -2dBs.

*RST value	Resolution	Options	SCPI
0	0.01 dB	B10/B11 and B13 K49 SOURce2 only with second option B9/B10/B11	Device-specific

[SOURce<[1]>:]BB:WIMax:AOFDM[:ZONE<0...7>]:BURSt<0...63>:RANGing:ACODE?

The command queries the number of allocated codes for OFDMA ranging.

The command is a query and therefore does not have an \*RST value.

Burst Type Ranging is available in uplink only.

**Example:** "BB:WIM:AOFDM:ZONE0:BURS2:RANG:ACOD?"  
'queries the number of allocated code.

*RST value	Resolution	Options	SCPI
		B10/B11 and B13 K49 SOURce2 only with second option B9/B10/B11	Device-specific

[SOURce<[1]>:]BB:WIMax:AOFDM[:ZONE<0...7>]:BURSt<0...63>:RANGing:OPPportunity:SIZE  
1 ... 4

The command sets the ranging opportunity size. The opportunity size specifies the number of symbols required to transmit one CDMA ranging code.

Burst Type Ranging is available in uplink only.

**Example:** "BB:WIM:AOFDM:ZONE0:BURS2:RANG:OPP:SIZE 2"  
'sets a opportunity size of 2.

*RST value	Resolution	Options	SCPI
1		B10/B11 and B13 K49 SOURce2 only with second option B9/B10/B11	Device-specific

**[SOURce<[1]>:]BB:WiMax:AOFDM[:ZONE<0...7>]:BURSt<0...63>:RANGing:OPPportunity:SLOT count 1 ... MAX**

The command sets the number of ranging opportunity slots. The number of opportunity slots defines the length of the ranging allocation, which is OpportunitySize \* NoOfOpportunitySlots OFDMA symbols.

Burst Type Ranging is available in uplink only.

**Example:** "BB:WIM:AOFD:ZONE0:BURS2:RANG:OPP:SLOT 2"  
'sets a number of 2 opportunity slots.

*RST value	Resolution	Options	SCPI
1		B10/B11 and B13 K49 SOURce2 only with second option B9/B10/B11	Device-specific

**[SOURce<[1]>:]BB:WiMax:AOFDM[:ZONE<0...7>]:BURSt<0...63>:RANGing:OPPportunity:SCGC ount 1 ... 10**

The command sets the number of ranging sub channel groups.

Burst Type Ranging is available in uplink only.

**Example:** "BB:WIM:AOFD:ZONE0:BURS2:RANG:SCGC 2"  
'sets a number of 2 opportunity subchannel groups.

*RST value	Resolution	Options	SCPI
1		B10/B11 and B13 K49 SOURce2 only with second option B9/B10/B11	Device-specific

**[SOURce<[1]>:]BB:WiMax:AOFDM[:ZONE<0...7>]:BURSt<0...63>:SLOT:COUNT 1 ... 10000**

The command sets the number of slots for the selected burst. If the number of slots is changed, the data length is adjusted to fill the specified number of slots with data so that no padding has to be applied.

The maximum data length of 10 000 bytes defines the maximum number of symbols for a given modulation type and channel coding rate.

This command is available in uplink only.

**Example:** "BB:WIM:AOFD:ZONE0:BURS2:SLOT:COUN 12"  
'sets 2 slots for burst 2.

*RST value	Resolution	Options	SCPI
1		B10/B11 and B13 K49 SOURce2 only with second option B9/B10/B11	Device-specific

[SOURce<[1]|2>:]BB:WIMax:AOFDm[:ZONE<0...7>]:BURSt<0...63>:SUBChannel[:COUNT] 1 ... 1000

The command sets the number of subchannels for the selected burst. If the number of subchannels is changed, the data length is adjusted to fill the specified number of symbols with data so that no padding has to be applied.

The maximum data length of 10 000 bytes defines the maximum number of symbols for a given modulation type and channel coding rate.

For physical layer mode OFDMA, this command is available in downlink only.

**Example:** "BB:WIM:AOFD:ZONE0:BURS2:SUBC:COUN 16"  
'sets 16 subchannels for burst 2.

*RST value	Resolution	Options	SCPI
1		B10/B11 and B13 K49 SOURce2 only with second option B9/B10/B11	Device-specific

[SOURce<[1]|2>:]BB:WIMax:AOFDm[:ZONE<0...7>]:BURSt<0...63>:SYMBol[:COUNT] 1 ...1000

The command sets the number of symbols for the selected burst. If the number of symbols is changed, the data length is adjusted to fill the specified number of symbols with data so that no padding has to be applied.

The maximum data length of 10 000 bytes defines the maximum number of symbols for a given modulation type and channel coding rate.

**Example:** "BB:WIM:AOFD:ZONE0:BURS2:SYMB: COUN 12"  
'sets 12 symbols for burst 2.

*RST value	Resolution	Options	SCPI
9		B10/B11 and B13 K49 SOURce2 only with second option B9/B10/B11	Device-specific

[SOURce<[1]|2>:]BB:WIMax:AOFDm[:ZONE<0...7>]:BURSt<0...63>:TYPE DATA | FCH | DLMap | ULMap | RANGing

The command selects the burst type.

Available burst types for downlink: DATA | FCH | DLMap | ULMap

Available burst types for uplink: DATA | RANGing

**Example:** "BB:WIM:AOFD:ZONE0:BURS2:TYPE DATA"  
'selects burst type DATA.

*RST value	Resolution	Options	SCPI
DATA		B10/B11 and B13 K49 SOURce2 only with second option B9/B10/B11	Device-specific

[SOURce<[1]2>:]BB:WiMax:AOFDm[:ZONE<0...7>]:BURSt<0...63>:UIUC 0.0 ... 15.0

The command sets uplink interval usage code. The UIUC is used for the UL-MAP, if generated.

This command is only available for link direction uplink.

**Example:** "BB:WIM:AOFD:ZONE0:BURS2:UIUC 2"  
'sets uplink interval usage code 2.

*RST value	Resolution	Options	SCPI
0		B10/B11 and B13 K49 SOURce2 only with second option B9/B10/B11	Device-specific

[SOURce<[1]2>:]BB:WiMax:AOFDm[:ZONE<0...7>]:BURSt<0...63>:ULMap:AMODe DLSFend | FRAMestart

The command sets the UL-MAP Allocation Start Time Base. Allocation Start Time field of the UL-MAP specifies the start of the uplink subframe.

This command is available for link direction downlink only.

**Example:** "BB:WIM:AOFD:ZONE0:BURS2:ULM:AMOD DLSF"  
'sets uplink interval usage code 2.

*RST value	Resolution	Options	SCPI
0		B10/B11 and B13 K49 SOURce2 only with second option B9/B10/B11	Device-specific

[SOURce<[1]2>:]BB:WiMax:AOFDm[:ZONE<0...7>]:BURSt<0...63>:ULMap:ATIME 0...frame duration

The command sets the UL-MAP Allocation Start Time.

This command is available for link direction downlink only.

**Example:** "BB:WIM:AOFD:ZONE0:BURS2:ULM:ATIM 4"  
'sets the allocation start time to 2..

*RST value	Resolution	Options	SCPI
0		B10/B11 and B13 K49 SOURce2 only with second option B9/B10/B11	Device-specific

[SOURce<[1]2>:]BB:WIMax:AOFDm:ZONE:COUNT 0...7

The command sets the number of active zones in one frame. The burst configuration is performed for each zone separately.)

**Example:** "BB:WIM:AOFD:ZONE:COUN 2"  
'two zones are defined.

*RST value	Resolution	Options	SCPI
1	-	B10/B11 and B13 K49 SOURce2 only with second option B9/B10/B11	Device-specific

[SOURce<[1]2>:]BB:WIMax:AOFDm[:ZONE<0...7>]:DLMap:BSID #H0,0 ... #FFFFFFFF,48

The command sets the 4 LSBs of the Base Station ID. Only the four least significant bits are given. The BSID is transmitted in the FCH (when set to **Auto** mode), and it is used to initialize the randomizer. ).

This command is available in downlink only and for DL-MAP Mode Auto (BB:WIM:AOFD:ZONE0:DLM:MODE AUTO).

**Example:** "BB:WIM:AOFD:ZONE0:DLM:BSID 2"  
'the base station id is 2.

*RST value	Resolution	Options	SCPI
#H0,0	-	B10/B11 and B13 K49 SOURce2 only with second option B9/B10/B11	Device-specific

[SOURce<[1]2>:]BB:WIMax:AOFDm[:ZONE<0...7>]:DLMap:DATA:DCD[:COUNT] 0 ... 255

The command sets the DCD Count. This value is used for the corresponding DL-MAP field in Auto mode.

This command is available in downlink only and for DL-MAP Mode Auto (BB:WIM:AOFD:ZONE:DLM:MODE AUTO).

**Example:** "BB:WIM:ZONE:AOFD:DLM:DCD 2"  
'sets the DCD count to 2.

*RST value	Resolution	Options	SCPI
0	-	B10/B11 and B13 K49 SOURce2 only with second option B9/B10/B11	Device-specific

**[SOURce<[1]|2>:]BB:WIMax:AOFDm[:ZONE<0...7>]:DLMap:FNOFset 0 ... 16777215**

The command sets the frame number offset of the DL map. This value is added to the current frame number of the sequence. The result is used as Frame Number in the DL-MAP (in Auto mode).

This command is available in downlink only and for DL-MAP Mode Auto (BB:WIM:AOFD:ZONE0:DLM:MODE AUTO).

**Example:** "BB:WIM:AOFD:ZONE0:DLM:FNOF 12"  
'sets a frame number offset of 2 frames

*RST value	Resolution	Options	SCPI
0	-	B10/B11 and B13 K49 SOURce2 only with second option B9/B10/B11	Device-specific

**[SOURce<[1]|2>:]BB:WIMax:AOFDm[:ZONE<0...7>]:DLMap:MODE USER | AUTO**

The command selects the mode for configuration of the DL map. Depending on this setting the above commands are available.

This command is available in downlink only.

**Parameter: AUTO**  
The DL-MAP is filled automatically with parameters specified at different locations.

**USER**  
The DL-MAP is filled with data specified under Data Source. This enables any arbitrary data to be sent with the DL-MAP burst.

**Example:** "BB:WIM:AOFD:ZONE0:DLM:MODE AUTO"  
'The DL-MAP is filled automatically.

*RST value	Resolution	Options	SCPI
AUTO	-	B10/B11 and B13 K49 SOURce2 only with second option B9/B10/B11	Device-specific

**[SOURce<[1]|2>:]BB:WIMax:AOFDm[:ZONE<0...7>]:DLMap:REPCoding RC0 | RC2 | RC4 | RC6**

The command activates/deactivates repetition coding. Setting RCO deactivates, all other settings activate repetition coding.

**Example:** "BB:WIM:AOFD:ZONE0:DLM:REPC RC2"  
'activates repetition coding.

*RST value	Resolution	Options	SCPI
RC0	-	B10/B11 and B13 K49 SOURce2 only with second option B9/B10/B11	Device-specific

[SOURce<[1]>:]BB:WIMax:AOFDm:ZONE<0...7>:FCH:MODE AUTO | USER

The command selects the mode for generating the FCH. Channel Coding of the FCH is performed both in **Auto** and **User** mode.

**Parameter: AUTO**

The DLFP fields, which form the FCH, are filled automatically with parameters specified at different locations. The following mapping applies in Auto mode:

Used subchannel bitmap:  
Set to the bitmap specified in the "Configure active Subchannels" panel.

Repetition\_Coding\_Indication:  
Specifies the DL-MAP repetition coding set in the "Configure DL-MAP" panel.

Coding\_Indication:  
Specifies channel coding of the DL-MAP (CC or CTC).

DL-Map\_Length:  
Set to the number of slots allocated for the DL-MAP.

**USER**

the FCH is filled with data specified under Data Source. This enables any arbitrary data to be sent with the FCH burst.

**Example:** "BB:WIM:AOFD:ZONE0:FCH:MODE AUTO"  
'selects FCH mode AUTO.

*RST value	Resolution	Options	SCPI
AUTO	-	B10/B11 and B13 K49 SOURce2 only with second option B9/B10/B11	Device-specific

[SOURce<[1]>:]BB:WIMax:AOFDm:ZONE<0...7>:NUMBER 0 ... 7

The command selects the zone number.

**Example:** "BB:WIM:AOFD:ZONE0:NUMB 4"  
'assigns number 4 to zone 1.

*RST value	Resolution	Options	SCPI
0	-	B10/B11 and B13 K49 SOURce2 only with second option B9/B10/B11	Device-specific

[SOURce<[1]>:]BB:WiMax:AOFDM:ZONE<0...7>:PERMbase 0 ... 127

The command selects the PermBase of the zone..

**Example:** "BB:WIM:AOFD:ZONE0:PERM 5"  
'selects PermBase 5.

*RST value	Resolution	Options	SCPI
0	-	B10/B11 and B13 K49 SOURce2 only with second option B9/B10/B11	Device-specific

[SOURce<[1]>:]BB:WiMax:AOFDM:ZONE<0...7>:PRBSid 0 ... 127

The command selects the PRBS\_ID of the zone...

**Example:** "BB:WIM:AOFD:ZONE0:PRBS 5"  
'selects PRBS\_ID 5.

*RST value	Resolution	Options	SCPI
0	-	B10/B11 and B13 K49 SOURce2 only with second option B9/B10/B11	Device-specific

[SOURce<[1]>:]BB:WiMax:AOFDM[:ZONE<0...7>]:TYPE PUSC | FUSC

The command selects the type of subcarrier permutation for OFDMA configurations.

**Example:** "BB:WIM:AOFD:ZONE0:TYPE PUSC"

*RST value	Resolution	Options	SCPI
FUSC	-	B10/B11 and B13 K49 SOURce2 only with second option B9/B10/B11	Device-specific

[SOURce<[1]>:]BB:WiMax:AOFDM:ZONE<0...7>:SCARrier:RANDomizer ON | OFF

The command activates / deactivates the subcarrier redomization for OFDMA configurations.

**Example:** "BB:WIM:AOFD:ZONE0:SCAR:RAND OFF"

*RST value	Resolution	Options	SCPI
ON	-	B10/B11 and B13 K49 SOURce2 only with second option B9/B10/B11	Device-specific



**[SOURce<[1]|2>:]BB:WiMax:AOFDM:ZONE<0...7>:SEGMENT 0...2**

The command selects the zone segment for OFDMA configurations.

**Example:** "BB:WIM:AOFDM:ZONE:SEGM 1"  
'selects one segment for zone 1.

*RST value	Resolution	Options	SCPI
0	-	B10/B11 and B13 K49 SOURce2 only with second option B9/B10/B11	Device-specific

**[SOURce<[1]|2>:]BB:WiMax:AOFDM:ZONE<0...7>:STC:ANTenna 0...2**

The command selects the the antenna for the space-timing coding.

**Example:** "BB:WIM:AOFDM:ZONE:STC:ANT ANT0"  
'selects antenna 0 for space time coding.

*RST value	Resolution	Options	SCPI
ANT0	-	B10/B11 and B13 K49 SOURce2 only with second option B9/B10/B11	Device-specific

**[SOURce<[1]|2>:]BB:WiMax:AOFDM:ZONE<0...7>:STC:MODE OFF | MA2antenna | MB2antenna**

The command sets the space-timing coding mode (2 antennas, matrix a or B) or switches diversity off.

**Example:** "BB:WIM:AOFDM:ZONE:STC:MODE MA2"  
'selects space time coding mode with two antennas and matrix A in zone 1.

*RST value	Resolution	Options	SCPI
OFF	-	B10/B11 and B13 K49 SOURce2 only with second option B9/B10/B11	Device-specific

**[SOURce<[1]>:]BB:WIMax:AOFDm[:ZONE<0...7>]:SUBChannel<0 ...5>:MAP ON | OFF**

The command activates /deactivates the selected set of subchannels. There are 6 sets of subchannels available 0 = 0...5; 1 = 6...9; 2 = 10-15; 3 = 16 - 19; 4 = 20 ...25; 5 = 26 ... 29).

This command is available only in uplink and for subchannel mode user (BB:WIM:AOFD:ZONE0:SUBC:MODE USER).

**Example:** "BB:WIM:AOFD:ZONE0:SUBC2:MAP ON"  
'activates subchannel set 2 (i.e. subchannels 6 ... 9).

*RST value	Resolution	Options	SCPI
0	-	B10/B11 and B13 K49 SOURce2 only with second option B9/B10/B11	Device-specific

**[SOURce<[1]>:]BB:WIMax:AOFDm[:ZONE<0...7>]:SUBChannel<n>:MODE ALL| USER**

The command determines if all or selected sets of subchannels are activated. The sets of subchannel to be activated are selected with command SOUR:BB:WIM:AOFD:ZONE0:SUBC2:MAP.

**Example:** "BB:WIM:AOFD:ZONE0:SUBC:MODE USER"  
'selects user mode for selecting the activated subchannels.

"BB:WIM:AOFD:ZONE0:SUBC2:MAP ON"  
'activates generation of set subchannels 20 to 31.

*RST value	Resolution	Options	SCPI
ALL	-	B10/B11 and B13 K49 SOURce2 only with second option B9/B10/B11	Device-specific

**[SOURce<[1]>:]BB:WIMax:AOFDm[:ZONE<0...7>]:SUBChannel<n>:PATTern #HF..., 72**

The command determines the 'allocated subchannel bitmap'. The pattern is a 72 bit value.

This command is available in uplink only.

**Example:** "BB:WIM:AOFD:ZONE0:SUBC:PATT #HFFFFFFFFFFFFFFFF3F, 72"  
'determines the 'allocated subchannel bitmap'

*RST value	Resolution	Options	SCPI
#HFFFFFFFFFFFFFFFF FF3F,72	-	B10/B11 and B13 K49 SOURce2 only with second option B9/B10/B11	Device-specific

**[SOURce<[1]>:]BB:WIMax:AOFDm:ZONE<0...7>:SYMBOL[:COUNT] 0...MAX**

The command selects the number of symbols in UL zone for OFDMA configurations. The duration of uplink bursts can not exceed the specified number of symbols.

**Example:** "BB:WIM:AOFD:ZONE:SYMB:COUN 3"  
'selects 3 symbols for zone 1.

*RST value	Resolution	Options	SCPI
	-	B10/B11 and B13 K49 SOURce2 only with second option B9/B10/B11	Device-specific

**[SOURce<[1]>:]BB:WIMax:AOFDm:ZONE<0...7>:SYMBOL[:COUNT]:AUTO ON | OFF**

The command activates or deactivates automatic zone length. In auto mode, the number of symbols in the zone is derived from the configured bursts such that all bursts fit into the zone, except if the frame duration is exceeded.

This command is available in downlink only.

**Example:** "BB:WIM:AOFD:ZONE:SYMB:AUTO ON"  
'activates automatic symbol count for zone 1.

*RST value	Resolution	Options	SCPI
OFF	-	B10/B11 and B13 K49 SOURce2 only with second option B9/B10/B11	Device-specific

**[SOURce<[1]>:]BB:WIMax:AOFDm:ZONE<0...7>:SYMBOL:OFFSet ?**

The command queries the symbol offset of the zone.

The command is a query and therefore does not have an \*RST value.

**Example:** "BB:WIM:AOFD:ZONE:SYMB:OFFS?"  
'queries the symbol count offset in zone 1.

*RST value	Resolution	Options	SCPI
	-	B10/B11 and B13 K49 SOURce2 only with second option B9/B10/B11	Device-specific

**[SOURce<[1]>:]BB:WiMax:AOFDm[:ZONE<0...7>]:TYPE** PUSC | FUSC

The command selects the zone type. This setting is identical to the setting of the type of subcarrier permutation for OFDMA configurations, a change here also changes the value of command BB:WIM:AOFD:ZONE:SUBC:PERM.

**Example:** "BB:WIM:AOFD:TYPE PUSC"

*RST value	Resolution	Options	SCPI
FUSC	-	B10/B11 and B13 K49 SOURce2 only with second option B9/B10/B11	Device-specific

**[SOURce<[1]>:]BB:WiMax:AOFDm[:ZONE<0...7>]:UCD** 0...255

The command sets the value for the UCD count.

This command is available in uplink only.

**Example:** "BB:WIM:AOFD:ZONE0:UCD 255"

*RST value	Resolution	Options	SCPI
0	-	B10/B11 and B13 K49 SOURce2 only with second option B9/B10/B11	Device-specific

**[SOURce<[1]>:]BB:WiMax:AOFDm[:ZONE<0...7>]:ULMap:CREate** <file\_name>

The command saves the current UL-map. The default directory is set using command MMEM:CDIRectory. A path can also be specified, in which case the UL-map files in the specified directory are read. The file are stored with the extension \*.dm\_iqd .

This command is available in uplink only.

**Example:** "BB:WIM:AOFD:ZONE1:ULM:CRE 'ul-map\_zone1'"

*RST value	Resolution	Options	SCPI
-	-	B10/B11 and B13 K49 SOURce2 only with second option B9/B10/B11	Device-specific

## SOURCE-WiMax - OFDM Physical Layer Settings

The SOURCE:BB:WiMax:OFDM system contain commands for setting the characteristics of signals with OFDM physical layer.

The commands of this system only take effect if the OFDM physical layer mode is selected:  
SOURCE:BB:WiMax:MODE OFDM

### Important:

*In case of remote control, suffix counting for bursts corresponds to the suffix counting with WiMAX starting with burst 0. SCPI prescribes that suffix 1 is the default state and used when no specific suffix is specified. Therefore, burst 1 (and not burst 0) is selected when no suffix is specified.*

Command	Parameters	Default unit	Comments
[SOURCE<[1]>:]BB:WiMax:OFDM:BSID	0...15		
[SOURCE<[1]>:]BB:WiMax:OFDM:BURSt[:COUNT]	1...8		
[SOURCE<[1]>:]BB:WiMax:OFDM:BURSt<0...63>:CCODing:STATe	ON   OFF		
[SOURCE<[1]>:]BB:WiMax:OFDM:BURSt<0...63>:DATA	PN9   PN15   PN16   PN20   PN21   PN23   ZERO   ONE   PATTErn   DLISt		
[SOURCE<[1]>:]BB:WiMax:OFDM:BURSt<0...63>:DATA:DSElect	<dlist_name>		
[SOURCE<[1]>:]BB:WiMax:OFDM:BURSt<0...63>:DATA:PATTErn	#B0,1...B11..1,64		
[SOURCE<[1]>:]BB:WiMax:OFDM:BURSt<0...63>:DIUC	0.0 ... 15.0		
[SOURCE<[1]>:]BB:WiMax:OFDM:BURSt<0...63>:DLEngth	0 .. 10 000	Bytes	
[SOURCE<[1]>:]BB:WiMax:OFDM:BURSt<0...63>:FORMat	BPSK1D2   QPSK1D2   QPSK3D4   QAM1D2X16   QAM3D4X16   QAM2D3X64   QAM3D4X64		
[SOURCE<[1]>:]BB:WiMax:OFDM:BURSt<0...63>:GAP	0 us ... 1 000 000 us	s	
[SOURCE<[1]>:]BB:WiMax:OFDM:BURSt<0...63>:MAC:CID	H0 ... HFFFF		
[SOURCE<[1]>:]BB:WiMax:OFDM:BURSt<0...63>:MAC:CRC:STATe	ON   OFF		
[SOURCE<[1]>:]BB:WiMax:OFDM:BURSt<0...63>:MAC:EKS	0 ... 4		
[SOURCE<[1]>:]BB:WiMax:OFDM:BURSt<0...63>:MAC:ENCRypted:STATe	ON   OFF		
[SOURCE<[1]>:]BB:WiMax:OFDM:BURSt<0...63>:MAC:STATe	ON   OFF		
[SOURCE<[1]>:]BB:WiMax:OFDM:BURSt<0...63>:MAC:TYPE	#H0...#H3F		
[SOURCE<[1]>:]BB:WiMax:OFDM:BURSt<0...63>:MIDamble	OFF   REP5   REP9   REP17		
[SOURCE<[1]>:]BB:WiMax:OFDM:BURSt<0...63>:POWEr	-80 dB ... 0 dB	dB	
[SOURCE<[1]>:]BB:WiMax:OFDM:BURSt<0...63>:PREamble:MODE	OFF   LONG   SHORT		
[SOURCE<[1]>:]BB:WiMax:OFDM:BURSt<0...63>:SYMBol[:COUNT]	0 ... MAX		
[SOURCE<[1]>:]BB:WiMax:OFDM:BURSt<0...63>:TYPE	DATA   DLMap   RANGing   ULMap		
[SOURCE<[1]>:]BB:WiMax:OFDM:BURSt<0...63>:UIUC	0.0 ... 15.0		
[SOURCE<[1]>:]BB:WiMax:OFDM:BURSt<0...63>:ULMap:AMODE	DLSFend   FRAMestart		
[SOURCE<[1]>:]BB:WiMax:OFDM:BURSt<0...63>:ULMap:ATIME	0...frame duration		
[SOURCE<[1]>:]BB:WiMax:OFDM:BW	1.25E6 ... 28E6		

Command	Parameters	Default unit	Comments
[SOURce<[1]>:]BB:WiMax:OFDM:FBANd	ETSI   MMDS   WCS   UNII   USER		
[SOURce<[1]>:]BB:WiMax:OFDM:FCH:CCC	0 ... 15		
[SOURce<[1]>:]BB:WiMax:OFDM:FCH:DATA	PN9   PN15   PN16   PN20   PN21   PN23   ZERO   ONE   PATtern   DLISt		
[SOURce<[1]>:]BB:WiMax:OFDM:FCH:DATA:DSElect	<dlist_name>		
[SOURce<[1]>:]BB:WiMax:OFDM:FCH:DATA:PATtern	#B0,1...B11..1,64		
[SOURce<[1]>:]BB:WiMax:OFDM:FCH:FNOFset	0 ... 15		
[SOURce<[1]>:]BB:WiMax:OFDM:FCH:MODE	AUTO   USER		
[SOURce<[1]>:]BB:WiMax:OFDM:FCH:STATe	IN   OFF		
[SOURce<[1]>:]BB:WiMax:OFDM:FFT			Query only
[SOURce<[1]>:]BB:WiMax:OFDM:FRAMe:PREDefined	USER   FBPSK12SHORT   FBPSK12MID   FBPSK12LONG   FQPSK12SHORT   FQPSK12MID   FQPSK12LONG   FQPSK34SHORT   FQPSK34MID   FQPSK34LONG   F16QAM12SHORT   F16QAM12MID   F16QAM12LONG   F16QAM34SHORT   F16QAM34MID   F16QAM34LONG   F64QAM23SHORT   F64QAM23MID   F64QAM23LONG   F64QAM34SHORT   F64QAM34MID   F64QAM34LONG		
[SOURce<[1]>:]BB:WiMax:OFDM:FRAMe[:NUMBer]	0 ... 15		
[SOURce<[1]>:]BB:WiMax:OFDM:N			Query only
[SOURce<[1]>:]BB:WiMax:OFDM:POWer:REFerence	BURSt   PREamble		
[SOURce<[1]>:]BB:WiMax:OFDM:PREamble:MODE	OFF   LONG   SHORT		
[SOURce<[1]>:]BB:WiMax:OFDM:SRATe	Slot 0 ...slot 14		
[SOURce<[1]>:]BB:WiMax:OFDM:SUBChannel[:COUNT]	SC1   SC2   SC4   SC8   SC16		
[SOURce<[1]>:]BB:WiMax:OFDM:SUBHannel:INDex	0 ... 15		
[SOURce<[1]>:]BB:WiMax:OFDM:TGTB	TGTB1D4   TGTB1D8   TGTB1D16   TGTB1D32		
[SOURce<[1]>:]BB:WiMax:OFDM:UCD	0..255		
[SOURce<[1]>:]BB:WiMax:OFDM:ULMap:CREate	<file_name>		

[SOURce<[1]|2>:]BB:WIMax:OFDM:BSID 1 ... 15

The command sets the 4 LSBs of the Base Station ID. Only the four least significant bits are given. The BSID is transmitted in the FCH (when set to **Auto** mode), and it is used to initialize the randomizer. ).

**Example:** "BB:WIM:OFDM:BSID 2"  
'the base station id is 2.

*RST value	Resolution	Options	SCPI
0	-	B10/B11 and B13 K49 SOURce2 only with second option B9/B10/B11	Device-specific

[SOURce<[1]|2>:]BB:WIMax:OFDM:BURSt[:COUNT ] 1 ... 8

The command sets the number of active bursts in one frame. With number of bursts = 0, a preamble only or a preamble with an FCH burst is generated).

**Example:** "BB:WIM:OFDM:BURS:COUN 2"  
'two bursts are sent in one frame.

*RST value	Resolution	Options	SCPI
1	-	B10/B11 and B13 K49 SOURce2 only with second option B9/B10/B11	Device-specific

[SOURce<[1]|2>:]BB:WIMax:OFDM:BURSt:CCODing:STATe ON | OFF

The command switches channel coding on or off. . If channel coding is switched off, the bits read from the data source are directly modulated onto the carriers. Due to randomization missing, this could result in very high crest factors of the signal.

**Example:** "BB:WIM:OFDM:BURS:CCOD:STAT ON"  
'activates channel coding for burst 1.

*RST value	Resolution	Options	SCPI
ON	-	B10/B11 and B13 K49 SOURce2 only with second option B9/B10/B11	Device-specific

**[SOURce<[1]|2>:]BB:WiMax:OFDM:BURSt<0...63>:DATA**  
 PN9 | PN15 | PN16 | PN20 | PN21 | PN23 | DLIS | ZERO | ONE | PATTErn

The command determines the data source for the specified bursts.

**Parameters:**     **PNxx**  
 The pseudo-random sequence generator is used as the data source. Different random sequence lengths can be selected.

**DLIS**  
 A data list is used. The data list is selected with the command  
 :BB:WiMax:OFDM:BURS:DATA:DSElect.

**ZERO | ONE**  
 Internal 0 and 1 data is used

**PATTErn**  
 Internal data is used The bit pattern for the data is defined by the command  
 :BB:WiMax:OFDM:BURS:DATA:PATTErn.

**Example:**         "BB:WIM:OFDM:BURS:DATA PATT"  
 'selects as the data source for the data fields of burst 1, the bit pattern defined with the following command.  
 "BB:WIM:OFDM:BURS:DATA: PATT #H3F, 8"  
 'defines the bit pattern.

*RST value	Resolution	Options	SCPI
PN9	-	B10/B11 and B13 K49 SOURce2 only with second option B9/B10/B11	Device-specific

**[SOURce<[1]|2>:]BB:WiMax:OFDM:BURSt<0...63>:DATA:DSElect <data list name>**

The command selects the data list for the DLIS data source selection.

The lists are stored as files with the fixed file extensions \*.dm\_iqd in a directory of the user's choice. The directory applicable to the following commands is defined with the command MMEMory:CDIR. To access the files in this directory, you only have to give the file name, without the path and the file extension.

**Example:**         "BB:WIM:OFDM:BURS:DATA DLIS"  
 'selects the Data Lists data source.  
 "MMEM:CDIR 'D:\Lists\DM\IqData'"  
 'selects the directory for the data lists.  
 "BB:WIM:OFDM:BURS:DATA:DLIS 'wimax\_list1'"  
 'selects file 'wimax\_list1' as the data source. This file must be in the directory D:\Lists\DM\IqData and have the file extension \*.dm\_iqd.

*RST value	Resolution	Options	SCPI
-	-	B10/B11 and B13 K49 SOURce2 only with second option B9/B10/B11	Device-specific



[SOURce<[1]>]:]BB:WiMax:OFDM:BURSt<0...63>:DATA:PATtern #B0,1... #B111..1,64

The command determines the bit pattern for the PATtern selection. The maximum length is 64 bits.

**Example:** "BB:WIM:OFDM:BURSt:DATA:PATT #H3F,8"  
'defines the bit pattern.'

*RST value	Resolution	Options	SCPI
0	-	B10/B11 and B13 K49 SOURce2 only with second option B9/B10/B11	Device-specific

[SOURce<[1]>]:]BB:WiMax:OFDM:BURSt<0...63>:DIUC 0 ... 15

The command sets the specific interval usage code. The code is used to initialize the randomizer and is transmitted in the FCH

**Example:** "BB:WIM:OFDM:BURSt:DIUC 12"  
'sets Interval Usage Code12 for burst 2.'

*RST value	Resolution	Options	SCPI
1		B10/B11 and B13 K49 SOURce2 only with second option B9/B10/B11	Device-specific

[SOURce<[1]>]:]BB:WiMax:OFDM:BURSt<0...63>:DLENgth 0 ... 10 000 Bytes

The command sets the data length in bytes. The given number of bytes is read from the data source. The total number of data bytes in the burst (before channel coding) is determined as follows:

$$\text{TotalDataBytes} = \text{DataLength} + \text{MACHeaderBytes} + \text{CRCBytes} + \text{TailByte}$$

The tail byte is only added when channel coding is switched on. The same is the case for the MAC header and CRC, they are not added when switched off. Additionally padding with 0xFF bytes is applied at the end of the data sequence to reach an integer number of OFDM symbols.

The data length determines the number of symbols and vice versa. The maximum data length of 10000 bytes defines the maximum number of symbols for a given modulation type and channel coding rate.

**Example:** "BB:WIM:OFDM:BURSt:DLEN 256"  
'sets a data length of 256.'

*RST value	Resolution	Options	SCPI
100	-	B10/B11 and B13 K49 SOURce2 only with second option B9/B10/B11	Device-specific

**[SOURce<[1]>:]BB:WiMax:OFDM:BURSt<0...63>:FORMat** BPSK1D2 | QPSK1D2 | QPSK3D4 | QAM1D2X16 | QAM3D4X16 | QAM2D3X64 | QAM3D4X64

Selects the modulation and channel coding rate. Channel coding includes randomization, reed solomon coding, convontional coding and interleaving.

For a given modulation type and channel coding rate, the data length determines the number of symbols and vice versa.

**Example:** "BB:WIM:OFDM:BURS:FORM QAM3D4X64"  
 'selects modulation type 64QAM and a channel coding rate of 3.4 Msamples for burst 1.

*RST value	Resolution	Options	SCPI
BPSK1D2	-	B10/B11 and B13 K49 SOURce2 only with second option B9/B10/B11	Device-specific

**[SOURce<[1]>:]BB:WiMax:OFDM:BURSt<0...63>:GAP** 0 ... 1 s

The command sets the length of the gap between the selected burst and the next burst in  $\mu$ s. The setting is only available for transmission direction uplink.

**Example:** "BB:WIM:LINK UP"  
 'sets transmission direction uplink.  
 "BB:WIM:OFDM:BURS2:GAP 0.003"  
 'sets the gap between burst 2 and 3 to 3 ms.

*RST value	Resolution	Options	SCPI
0	1 us	B10/B11 and B13 K49 SOURce2 only with second option B9/B10/B11	Device-specific

**[SOURce<[1]>:]BB:WiMax:OFDM:BURSt<0...63>:MAC:CID** #H0...#HFFFF

The command sets the CID (connection control identifier) of the medium access control layer (MAC). The CID identifies a connection to equivalent peers in the MAC of the base station and subscriber station.

**Example:** "BB:WIM:OFDM:BURS2:MAC:CID #HE7"  
 'sets the CID for burst 2 to 231.

*RST value	Resolution	Options	SCPI
0	-	B10/B11 and B13 K49 SOURce2 only with second option B9/B10/B11	Device-specific

[SOURce<[1]>:]BB:WIMax:OFDM:BURSt<0...63>:MAC:CRC:STATe ON | OFF

The command activates/deactivates the checksum determination. The state of the CRC can be set independently of the state of MAC header generation.

**Example:** "BB:WIM:OFDM:BURS2:MAC:CRC:STAT ON"  
'activates the checksum determination for burst 2.

*RST value	Resolution	Options	SCPI
OFF	-	B10/B11 and B13 K49 SOURce2 only with second option B9/B10/B11	Device-specific

[SOURce<[1]>:]BB:WIMax:OFDM:BURSt<0...63>:MAC:EKS 0 ... 4

The command sets the EKS (encryption key sequence) value in the MAC header. The payload encryption itself is not performed by the signal generator.

**Example:** "BB:WIM:OFDM:BURS2:MAC:ENCR:STAT ON"  
'enables payload encryption.  
  
"BB:WIM:OFDM:BURS2:MAC:EKS 2"  
'sets the EKS for burst 2.

*RST value	Resolution	Options	SCPI
0		B10/B11 and B13 K49 SOURce2 only with second option B9/B10/B11	Device-specific

[SOURce<[1]>:]BB:WIMax:OFDM:BURSt<0...63>:MAC:ENCRypted:STATe ON | OFF

The command activates/disactivates payload encryption. If activated, the EC (encryption control) field is set to 1 and the EKS (encryption key sequence) field can be set.

**Example:** "BB:WIM:OFDM:BURS2:MAC:ENCR:STAT ON"  
'enables payload encryption for burst 2.  
  
"BB:WIM:OFDM:BURS2:MAC:EKS 2"  
'sets the EKS.

*RST value	Resolution	Options	SCPI
OFF		B10/B11 and B13 K49 SOURce2 only with second option B9/B10/B11	Device-specific

**[SOURce<[1]>:]BB:WIMax:OFDM:BURSt<0...63>:MAC:STATe** ON | OFF

The command enables/disables generation of the generic MAC header for the selected burst.

**Example:** "BB:WIM:OFDM:BURS2:MAC:STAT ON"  
 'enables generation of the generic MAC header for burst 2.

*RST value	Resolution	Options	SCPI
OFF		B10/B11 and B13 K49 SOURce2 only with second option B9/B10/B11	Device-specific

**[SOURce<[1]>:]BB:WIMax:OFDM:BURSt<0...63>:MAC:TYPE** #H0...#H3F

The command specifies the MAC type..The value of the 6-bit type field is set which indicates the payload type, including the presence of subheaders.

**Example:** "BB:WIM:OFDM:BURS2:MAC:TYPE #H3F"  
 'sets the type field of the MAC header of burst 2.

*RST value	Resolution	Options	SCPI
#H0		B10/B11 and B13 K49 SOURce2 only with second option B9/B10/B11	Device-specific

**[SOURce<[1]>:]BB:WIMax:OFDM:BURSt<0...63>:MIDamble** OFF | REP5 | REP9 | REP17

The command activates/deactivates midamble repetition. If midamble repetition is switched on, midambles are placed into the burst with the specified interval, i.e. if 5 is selected, every 5<sup>th</sup> symbol of the burst is a midamble.

A short preamble is used as midamble when subchannelization is off or a subchannelization preamble is used in subchannelization mode. The power of the midambles

**Example:** "BB:WIM:LINK UP"  
 'selects transmission direction uplink.  
 "BB:WIM:OFDM:BURS2:MID REP9"  
 'the midamble is repeated each 9<sup>th</sup> symbol of burst 2.

*RST value	Resolution	Options	SCPI
OFF	-	B10/B11 and B13 K49 SOURce2 only with second option B9/B10/B11	Device-specific

**[SOURce<[1]>:]BB:WIMax:OFDM:BURSt<0...63>:POWer -80 dB ... +10 dB**

The command sets the power for the selected burst in dB. To set the absolute power of a burst correctly, level reference **FCH / Burst** must be selected. In this mode, the output power of a burst equals Level + BurstPower. In downlink, the preamble is transmitted with +3dB and the FCH is transmitted with 0dB.

In uplink, the power of the first burst is fixed to 0dB.

**Example:** "BB:WIM:OFDM:BURS2:POW -2 dB"  
'sets the burst power to -2dBs.

*RST value	Resolution	Options	SCPI
0	0.01 dB	B10/B11 and B13 K49 SOURce2 only with second option B9/B10/B11	Device-specific

**[SOURce<[1]>:]BB:WIMax:OFDM:BURSt<0...63>:PREamble:MODE OFF | LONG | SHORT**

The command enables/disables generation of the preamble for the selected burst and selects the mode for generating the preamble. Either a long preamble or a short preamble can be activated.

The 802.16 standard requires a long preamble as frame start.

**Example:** "BB:WIM:OFDM:BURS2:PRE:MODE LONG"  
'enables generation of the long preamble for burst 2.

*RST value	Resolution	Options	SCPI
OFF		B10/B11 and B13 K49 SOURce2 only with second option B9/B10/B11	Device-specific

**[SOURce<[1]>:]BB:WIMax:OFDM:BURSt<0...63>:SYMBol[:COUNT] 1 ... 834**

The command sets the number of symbols for the selected burst. If the number of symbols is changed, the data length is adjusted to fill the specified number of symbols with data so that no padding has to be applied.

The maximum data length of 10 000 bytes defines the maximum number of symbols for a given modulation type and channel coding rate.

**Example:** "BB:WIM:OFDM:BURS2:SYMB:COUN 12"  
'sets 12 symbols for burst 2.

*RST value	Resolution	Options	SCPI
9		B10/B11 and B13 K49 SOURce2 only with second option B9/B10/B11	Device-specific

[SOURce<[1]|2>:]BB:WIMax:OFDM:BURSt<0...63>:TYPE DATA | FCH | DLMap | RANGing

The command selects the burst type.

Available burst types for downlink: DATA | ULMap | DLMap

Available burst types for uplink: DATA | RANGing

**Example:** "BB:WIM:OFDM:BURS2:TYPE DATA"  
'selects burst type DATA.

*RST value	Resolution	Options	SCPI
DATA		B10/B11 and B13 K49 SOURce2 only with second option B9/B10/B11	Device-specific

[SOURce<[1]|2>:]BB:WIMax:OFDM:BURSt<0...63>:UIUC 0.0 ... 15.0

The command sets uplink interval usage code.

This command is only available for link direction uplink

**Example:** "BB:WIM:OFDM:BURS2:UIUC 2"  
'sets uplink interval usage code 2.

*RST value	Resolution	Options	SCPI
0		B10/B11 and B13 K49 SOURce2 only with second option B9/B10/B11	Device-specific

[SOURce<[1]|2>:]BB:WIMax:OFDM:BURSt<0...63>:ULMap:AMODe DLSFend | FRAMestart

The command sets the UL-MAP Allocation Start Time Base. The start time is set either relative to the DL subframe end (DLSFend) or the frame start (FRAMestart).

This command is available for link direction downlink only.

**Example:** "BB:WIM:OFDM:BURS2:ULM:AMOD DLSF"  
'sets uplink interval usage code 2.

*RST value	Resolution	Options	SCPI
0		B10/B11 and B13 K49 SOURce2 only with second option B9/B10/B11	Device-specific

[SOURce<[1]]2>:BB:WIMax:OFDM:BURSt<0...63>:ULMap:ATIMe 0...frame duration

The command sets the UL-MAP Allocation Start Time.

This command is available for link direction downlink only.

**Example:** "BB:WIM:OFDM:BURS2:ULM:ATIM 4"  
'sets the allocation start time to 2..

*RST value	Resolution	Options	SCPI
0		B10/B11 and B13 K49 SOURce2 only with second option B9/B10/B11	Device-specific

[SOURce<[1]]2>:BB:WIMax:OFDM:BW 1.25 to 28 MHz

The command sets the channel bandwidth. The selected channel bandwidth has to be a multiple of 1.25, 1.5, 1.75, 2.0 or 2.75 MHz. The channel bandwidth determines the parameter n (sampling ratio, command SOUR:BB:WIMax:OFDM:N).

The sampling rate is derived from the channel bandwidth as follows:

$$\text{SamplingRate} = \text{floor}(n * \text{ChannelBandwidth} / 8000) * 8000$$

**Downlink:** The allowed values depend on the selected frequency band (command SOUR:BB:WIMax:OFDM:FBAN). Only discrete sets of values are available. If a new value is not allowed, the next allowed value in the direction of change is set.

**Uplink:** The full range between 1.25 and 28 MHz is available. Only discrete sets of values are available. If a new value is not allowed, the next allowed value in the direction of change is set.

**Example:** 14 MHz and 28 MHz are allowed, the current value is 14 MHz. If a new value of 15 MHz is entered it is changed to 28 MHz.

**Example:** "BB:WIM:OFDM:FBAN ETSI"  
'selects frequency band according to ETSI specifications.

"BB:WIM:OFDM:BW 7E6"  
'sets the channel bandwidth to 7 MHz.

*RST value	Resolution	Options	SCPI
1.75 MHz	-	B10/B11 and B13 K49 SOURce2 only with second option B9/B10/B11	Device-specific

[SOURce<[1]|2>:]BB:WiMax:OFDM:FBAND ETSI | MMDS | WCS | UNII | USER

The command selects the available frequency band for the carrier frequencies.

**Parameter:**

**ETSI**

The frequency band as defined by the **European Telecommunications Standards Institute** applies. The range is 1.75 to 28 MHz for the channel bandwidth and 2 to 32 MHz for the sampling rate.

**MMDS**

The frequency band as defined by the **Multichannel Multipoint Distribution Service** applies. The RF frequency range is 2500 to 2686 MHz. The range is 1.50 to 24 MHz for the channel bandwidth and 1.72 to 27.52 MHz for the sampling rate.

**WCS**

The frequency band as defined by the **Wireless Communication Service** applies. It is in the 2.3 GHz band of the electromagnetic spectrum from 2305 to 2320 MHz and 2345 to 2360 MHz. The range is 2.5 to 15 MHz for the channel bandwidth and 2.88 to 17.28 MHz for the sampling rate.

**UNII**

The frequency band as defined by the **Unlicensed National Information Infrastructure** applies. It is in the 5 GHz band of the electromagnetic spectrum from 5150 to 5350 GHz and 5750 to 5825 GHz. The range is 10 to 20 MHz for the channel bandwidth and 11.52 to 23.04 MHz for the sampling rate.

**USER**

This mode is provided for choosing any other channel bandwidth / sampling rate combination. The range is 1.25 to 28 MHz for the channel bandwidth and 1.44 to 32 MHz for the sampling rate.

**Example:**

"BB:WIM:OFDM:FBAN ETSI"  
'selects frequency band according to ETSI specifications.

*RST value	Resolution	Options	SCPI
ETSI	-	B10/B11 and B13 K49 SOURce2 only with second option B9/B10/B11	Device-specific

[SOURce<[1]|2>:]BB:WiMax:OFDM:FCH:CCC 0 ... 15

The command sets the configuration change count value. This value is used for the corresponding FCH field in **Auto** mode (SOURce:BB:WiMax:OFDM:FCH:MODE AUTO).

**Example:**

"BB:WIM:OFDM:FCH:CCC 4"  
'sets configuration change count value to 4.

*RST value	Resolution	Options	SCPI
0	-	B10/B11 and B13 K49 SOURce2 only with second option B9/B10/B11	Device-specific



**[SOURce<[1]|2>:]BB:WIMax:OFDM:FCH:DATA PN9 | PN15 | PN16 | PN20 | PN21 | PN23 | DLIS | ZERO | ONE | PATTErn**

The command specifies the data source in **User** mode (SOURce:BB:WIMax:OFDM:FCH:MODE AUTO). The FCH contents are filled from the selected data source.

**Parameters:**

**PNxx**

The pseudo-random sequence generator is used as the data source. Different random sequence lengths can be selected.

**DLIS**

A data list is used. The data list is selected with the command :BB:WIMax:OFDM:FCH:DATA:DSElect.

**ZERO | ONE**

Internal 0 and 1 data is used.

**PATTErn**

Internal data is used. The bit pattern for the data is defined by the command :BB:WIMax:OFDM:FCH:DATA:PATTErn

**Example:**

"BB:WIM:OFDM:FCH:DATA PATT"

'selects as the data source for the data fields of FCH, the bit pattern defined with the following command.

"BB:WIM:OFDM:FCH:DATA:PATT #H3F,8"

'defines the bit pattern.

*RST value	Resolution	Options	SCPI
PN9	-	B10/B11 and B13 K49 SOURce2 only with second option B9/B10/B11	Device-specific

**[SOURce<[1]|2>:]BB:WIMax:OFDM:FCH:DATA:DSElect <data list name>**

The command selects the data list for the DLIS data source selection.

The lists are stored as files with the fixed file extensions \*.dm\_iqd in a directory of the user's choice. The directory applicable to the following commands is defined with the command MMEMoRY:CDIR. To access the files in this directory, you only have to give the file name, without the path and the file extension.

This command is available only in **User** mode (SOURce:BB:WIMax:OFDM:FCH:MODE AUTO).

**Example:**

"BB:WIM:OFDM:FCH:DATA DLIS"

'selects the Data Lists data source.

"MMEM:CDIR 'D:\Lists\DM\IqData'"

'selects the directory for the data lists.

"BB:WIM:OFDM:FCH:DATA:DLIS 'wimax\_list1'"

'selects file 'wimax\_list1' as the data source. This file must be in the directory D:\Lists\DM\IqData and have the file extension \*.dm\_iqd.

*RST value	Resolution	Options	SCPI
-	-	B10/B11 and B13 K49 SOURce2 only with second option B9/B10/B11	Device-specific

**[SOURce<[1]|2>:]BB:WiMax:OFDM:FCH:DATA:PATtern**  
 #B0,1... #B111..1,64

The command determines the bit pattern for the PATtern selection. The maximum length is 64 bits. This command is available only in **User mode** (SOURce:BB:WiMax:OFDM:FCH:MODE AUTO).

**Example:** "BB:WIM:OFDM:BERS:DATA:PATT #H3F,8"  
 'defines the bit pattern.

*RST value	Resolution	Options	SCPI
0	-	B10/B11 and B13 K49 SOURce2 only with second option B9/B10/B11	Device-specific

**[SOURce<[1]|2>:]BB:WiMax:OFDM:FCH:FNOFset 0 ... 15**

The command sets the frame number offset. This value is added to the current frame number of the sequence. After modulo 16 division, the result is used as Frame\_Number in the FCH (in Auto mode) and is also used to initialize the randomizers.

**Example:** "BB:WIM:OFDM:FCH:FNOF 4"  
 'sets a frame number offset of 4.

*RST value	Resolution	Options	SCPI
0	-	B10/B11 and B13 K49 SOURce2 only with second option B9/B10/B11	Device-specific

[SOURce<[1]]2>:]BB:WIMax:OFDM:FCH:MODE AUTO | USER

The command selects the mode for generating the FCH. Channel Coding of the FCH is performed both in **Auto** and **User** mode.

**Parameter: AUTO**

The DLFP fields, which form the FCH, are filled automatically with parameters specified at different locations. The following mapping applies in Auto mode:

**Base\_Station\_ID:**

Set to the BSID value specified in the frame configuration menu.

**Frame\_Number:**

Set to the current frame number modulo 16. The first frame of the generated sequence has the number specified in Frame Number Offset below. For the following frames, this number will increase by 1 per frame.

**Configuration\_Change\_Count:**

Set to the value specified below.

**Rate\_ID:**

The Rate ID parameter of the first burst is set according to its modulation setting.

**DIUC:**

The DIUC value for the second, third and fourth burst is taken from the DIUC value in the burst table.

**Preamble Present:**

Set to 1 when the burst preamble is activated for the corresponding burst.

**Length:**

Set to the calculated number of symbols of the corresponding burst.

**HCS:**

The Header Check Sequence is automatically calculated.

**USER**

the FCH is filled with data specified under Data Source. This enables any arbitrary data to be sent with the FCH burst.

**Example:** "BB:WIM:OFDM:FCH:MODE AUTO"  
'selects FCH mode AUTO.

*RST value	Resolution	Options	SCPI
AUTO	-	B10/B11 and B13 K49 SOURce2 only with second option B9/B10/B11	Device-specific

[SOURce<[1]|2>:]BB:WiMax:OFDM:FCH:STATe ON | OFF

The command switches the FCH on or off.

**Example:** "BB:WIM:OFDM:FCH:STAT OFF"  
'switches off generation of FCH.

*RST value	Resolution	Options	SCPI
ON	-	B10/B11 and B13 K49 SOURce2 only with second option B9/B10/B11	Device-specific

[SOURce<[1]|2>:]BB:WiMax:OFDM:FFT FFT256

The command sets the size of the fast fourier transform. For OFDM channels, the size is fixed to 256. For OFDMA configuration, the possible configurations of the subchannel map depend on the selected FFT size.

**Example:** "BB:WIM:OFDM:FFT?"  
'queries the FFT size

Response: "FFT256"  
'the FFT size is 256

*RST value	Resolution	Options	SCPI
OFDMA: FFT2048 OFDM: FFT256	-	B10/B11 and B13 K49 SOURce2 only with second option B9/B10/B11	Device-specific

**[SOURce<[1]>:]BB:WIMax:OFDM:FRAME:PREDefined** USER | FBPSK12SHORT | FBPSK12MID | FBPSK12LONG | FQPSK12SHORT | FQPSK12MID | FQPSK12LONG | FQPSK34SHORT | FQPSK34MID | FQPSK34LONG | F16QAM12SHORT | F16QAM12MID | F16QAM12LONG | F16QAM34SHORT | F16QAM34MID | F16QAM34LONG | F64QAM23SHORT | F64QAM23MID | F64QAM23LONG | F64QAM34SHORT | F64QAM34MID | F64QAM34LONG

The command selects predefined setting for the frames.

**Parameter:** USER

The settings for the frame can be defined by the user.

**F...**

Predefined settings for receiver testing are selected. The parameter includes the modulation, the channel coding rate and the test message type (long, short or middle). See IEEE 802.16-2004, section 8.3.11 for details.

**Example:**

"BB:WIM:LINK UP"

'selects transmission direction uplink.

"BB:WIM:OFDM:FRAM: PRED FBPSK12LONG"

'selects predefined settings with BPSK modulation, channel coding 1 / 2 and long test message.

*RST value	Resolution	Options	Dependencies	SCPI
USER	-	B10/B11 and B13 K49 SOURce2 only with second option B9/B10/B11	All commands concerning the frame configuration are preset	Device-specific

**[SOURce<[1]>:]BB:WIMax:OFDM:FRAME[:NUMBER]** 0 ... 15

The command selects the frame number of the uplink frame in which the UL map that specifies the uplink burst was transmitted.

This command is available in uplink only.

**Example:**

"BB:WIM:LINK UP"

'selects transmission direction uplink.

"BB:WIM:MODE OFDM"

'selects OFDM physical layer mode.

"BB:WIM:OFDM:FRAM 15"

'selects frame number 15.

*RST value	Resolution	Options	SCPI
0	-	B10/B11 and B13 K49 SOURce2 only with second option B9/B10/B11	Device-specific

[SOURce<[1]|2>:]BB:WIMax:OFDM:N

The command queries the factor n (sampling ratio). The sampling ratio is determined by the channel bandwidth (see parameter **Channel Bandwidth**).

The command is a query and therefore does not have an \*RST value.

**Example:** "BB:WIM:OFDM:N?"  
'queries the factor n.

Response: "N8D7"  
'the factor n is 8/7.

*RST value	Resolution	Options	SCPI
-	-	B10/B11 and B13 K49 SOURce2 only with second option B9/B10/B11	Device-specific

[SOURce<[1]|2>:]BB:WIMax:OFDM:POWer:REFerence BURSt | PREAmble

The command selects the level reference.

**Parameter: BURSt**  
The instrument's level setting refers to the mean power of FCH or bursts with a burst power setting of 0 dB. To obtain the absolute burst power value, the burst power value has to be added to the level value.

**PREAmble**  
The instrument's level setting refers to the preamble, which is FCH / Burst power + 3dB.

**Example:** "BB:WIM:OFDM:POW:REF BURSt"  
'the instrument's level setting refers to the mean power of FCH or bursts with a burst power setting of 0 dB.

*RST value	Resolution	Options	SCPI
BURSt	-	B10/B11 and B13 K49 SOURce2 only with second option B9/B10/B11	Device-specific

[SOURce<[1]|2>:]BB:WIMax:OFDM:PREAmble:MODE OFF | LONG | SHORt

The command activates/deactivates the generation of a frame preamble. Either a long preamble or a short preamble can be activated. The 802.16 standard requires a long preamble as frame start in the downlink.

**Example:** "BB:WIM:OFDM:PRE:MODE SHORt"  
'enables generation of a short preamble for the frame.

*RST value	Resolution	Options	SCPI
LONG		B10/B11 and B13 K49 SOURce2 only with second option B9/B10/B11	Device-specific

**[SOURce<[1]>:]BB:WIMax:OFDM:SRATe** 1.44 MHz ... 32 MHz

The command sets the sampling rate. The sampling rate is related to the channel bandwidth by the parameter n:

$$\text{SamplingRate} = \text{floor}(n * \text{ChannelBandwidth} / 8000) * 8000$$

**Downlink:**

The value range depends on the selected frequency band (command SOUR:BB:WIMax:OFDM:FBAN). Only discrete sets of values are available. If a new value is not allowed, the next allowed value in the direction of change is set.

**Uplink:**

The full range between 1.44 and 32 MHz is available. Only discrete sets of values are available. If a new value is not allowed, the next allowed value in the direction of change is set.

**Example:** 16 MHz and 32 MHz are allowed, the current value is 16 MHz. If a new value of 17 MHz is entered it is changed to 32 MHz.

**Example:** "BB:WIM:OFDM:SRAT 2E6"  
'sets a sampling rate of 2 MHz.

*RST value	Resolution	Options	SCPI
2 MHz	1 kHz	B10/B11 and B13 K49 SOURce2 only with second option B9/B10/B11	Device-specific

**[SOURce<[1]>:]BB:WIMax:OFDM:SUBChannel[:COUNT]** SC1 | SC2 | SC4 | SC8 | SC16

The command selects the number of subchannels für OFDM configurations.

Selection 16 (all) deactivates subchannelization and activates all possible carriers. The values 1, 2, 4 and 8 activate only a part of the available subcarriers, unused carriers are blanked.

**Example:** "BB:WIM:OFDM:SUBC:COUN SC4"  
'selects 4 subchannels to be used.

*RST value	Resolution	Options	SCPI
SC16	-	B10/B11 and B13 K49 SOURce2 only with second option B9/B10/B11	Device-specific

**[SOURce<[1]>:]BB:WIMax:OFDM:SUBChannel:INDEX** SUBC1 ... SUBC31

The command selects the subchannel index in subchannelization mode. The subchannel index determines the set of used subcarriers according to table 213 of IEEE 802.16-2004 standard.

**Example:** "BB:WIM:OFDM:SUBC:IND SUBC4"  
'selects subchannel set 4 to be used.

*RST value	Resolution	Options	SCPI
SUBC16	-	B10/B11 and B13 K49 SOURce2 only with second option B9/B10/B11	Device-specific

[SOURce<[1]>:]BB:WiMax:OFDM:TGTB TGTB1D4 | TGTB1D8 | TGTB1D16 | TGTB1D32

The command selects the ratio of guard period to symbol period. This value sets the length of the cyclic prefix in fractions of the symbol period.

**Example:** "BB:WIM:OFDM:TGTB TGTB1D8"  
'sets a ratio of 1 to 8.'

*RST value	Resolution	Options	SCPI
1D4	-	B10/B11 and B13 K49 SOURce2 only with second option B9/B10/B11	Device-specific

[SOURce<[1]>:]BB:WiMax:OFDM:UCD 0...255

The command sets the value for the UCD count.

This command is available in uplink only.

**Example:** "BB:WIM:OFDM:UCD 255"

*RST value	Resolution	Options	SCPI
0	-	B10/B11 and B13 K49 SOURce2 only with second option B9/B10/B11	Device-specific

[SOURce<[1]>:]BB:WiMax:OFDM:ULMap:CREate <file\_name>

The command saves the current UL-map. The default directory is set using command `MMEM:CDIRECTory`. A path can also be specified, in which case the UL-map files in the specified directory are read. The file are stored with the extension `*.dm_iqd`.

This command is available in uplink only.

**Example:** "BB:WIM:OFDM:ULM:CRE 'ul-map\_zone1'"

*RST value	Resolution	Options	SCPI
-	-	B10/B11 and B13 K49 SOURce2 only with second option B9/B10/B11	Device-specific



## SOURce:BB:WLAN Subsystem

This subsystem contains commands for the primary and general settings of the IEEE 802.11a-g WLAN standard. These settings concern activation and deactivation of the standard, setting the transmission direction, filter, clock, trigger and clipping settings, defining the frame duration and the sequence length, as well as the preset setting.

The commands for defining the frame configuration for physical layer modes OFDM and CCK/PBCC are described in the next section. The commands are divided up in this way to make the comprehensive SOURce:BB:WLAN subsystem clearer.

The numerical suffix at SOURce distinguishes between path A and path B for two-path instruments:

SOURce<1> = path A

SOURce2 = path B

The keyword SOURce is optional with commands for path A and can be omitted. For path B, the command must include the keyword with the suffix 2.

Command	Parameters	Default unit	Comments
[SOURce<[1]2>:]BB:WLAN:CLIPping:LEVel	1...100	PCT	
[SOURce<[1]2>:]BB:WLAN:CLIPping:MODE	VECTor   SCALar		
[SOURce<[1]2>:]BB:WLAN:CLIPping:STATe	ON   OFF		
[SOURce<[1]2>:]BB:WLAN:CLOCK:MODE	CHIP   MCHip		
[SOURce<[1]2>:]BB:WLAN:CLOCK:MULTIplier	1... 64		
[SOURce<[1]2>:]BB:WLAN:CLOCK:SOURce	EXTernal   INTernal		
[SOURce<[1]2>:]BB:WLAN:CRATe:VARiation	0.001 ... 100 MHz	Hz (c/s)	
[SOURce<[1]2>:]BB:WLAN:FFORmat	DATA   RTS   CTS   ACK		
[SOURce<[1]2>:]BB:WLAN:FILTer:PARAmeter:APCO25	0.15 ... 2.5		
[SOURce<[1]2>:]BB:WLAN:FILTer:PARAmeter:COSSine	0.05 ... 0.99		
[SOURce<[1]2>:]BB:WLAN:FILTer:PARAmeter:GAUSSs	0.15 ... 2.5		
[SOURce<[1]2>:]BB:WLAN:FILTer:PARAmeter:PGAuss	0.15 ... 2.5		
[SOURce<[1]2>:]BB:WLAN:FILTer:PARAmeter:RCOSSine	0.05 ... 0.99		
[SOURce<[1]2>:]BB:WLAN:FILTer:PARAmeter:SPHase	0.15 ... 2.5		
[SOURce<[1]2>:]BB:WLAN:FILTer:TYPE	RCOSSine   COSSine   GAUSSs   LGAuss   CONE   COF705   COEqualizer   COFequalizer   C2K3x   APCO25   SPHase   RECTangle   PGAuss		
[SOURce<[1]2>:]BB:WLAN:ILEaver:STATe	ON   OFF		
[SOURce<[1]2>:]BB:WLAN:ITIME	0.0 .... 1E-1		
[SOURce<[1]2>:]BB:WLAN:PLCP:FORMat	LONG   SHORT		
[SOURce<[1]2>:]BB:WLAN:PLCP:LCBit:STATe	ON   OFF		
[SOURce<[1]2>:]BB:WLAN:MODE	OFDM   CCK   PBCC		
[SOURce<[1]2>:]BB:WLAN:PRESet			No query

Command	Parameters	Default unit	Comments
[SOURce<[1]>:]BB:WLAN:SCRambler:MODE	ON   OFF   RANDom   USER   PONLy		
[SOURce<[1]>:]BB:WLAN:SCRambler:PATtern	0x0 .. 0xFF		
[SOURce<[1]>:]BB:WLAN:SEQuence	AUTO   RETRigger   AAUTO   ARETrigger   SINGle		
[SOURce<[1]>:]BB:WLAN:SERvice:PATtern	0x0 .. 0xFFFF		
[SOURce<[1]>:]BB:WLAN:SETTing:CATalog?			Query only
[SOURce<[1]>:]BB:WLAN:SETTing:DELeTe	<file_name>		
[SOURce<[1]>:]BB:WLAN:SETTing:LOAD	<file_name>		
[SOURce<[1]>:]BB:WLAN:SETTing:STORe	<file_name>		
[SOURce<[1]>:]BB:WLAN:SLENgth	1... MAX		
[SOURce<[1]>:]BB:WLAN:SMODE	FRAMed   UNFRamed		
[SOURce<[1]>:]BB:WLAN:STANdard	STAN80211A   STAN80211B   STAN80211G		
[SOURce<[1]>:]BB:WLAN:STATe	ON   OFF		
[SOURce<[1]>:]BB:WLAN::TDWindowing:STATe	ON   OFF		
[SOURce<[1]>:]BB:WLAN:TRIGger:ARM:EXECute			No query
[SOURce<[1]>:]BB:WLAN:TRIGger:EXECute			No query
[SOURce<[1]>:]BB:WLAN:TRIGger[:EXtErnal<[1]>]:DELay	0 ... (2 <sup>32</sup> - 1) chips		
[SOURce<[1]>:]BB:WLAN:TRIGger[:EXtErnal<[1]>]:INHibit	0 ... (2 <sup>32</sup> - 1) chips		
[SOURce<[1]>:]BB:WLAN:TRIGger:OBASeband:DELay	0 ... (2 <sup>32</sup> - 1) chips		
[SOURce<[1]>:]BB:WLAN:TRIGger:OBASeband:INHibit	0 ... (2 <sup>32</sup> - 1) chips		
[SOURce<[1]>:]BB:WLAN:TRIGger:OUTPut<[1]...4>:DELay	0 ... (2 <sup>32</sup> - 1) chips		
[SOURce<[1]>:]BB:WLAN:TRIGger:OUTPut:DELay:FIXed	ON   OFF	Hz	
[SOURce<[1]>:]BB:WLAN:TRIGger:OUTPut<[1]...4>:DELay:MAXimum			Query only
[SOURce<[1]>:]BB:WLAN:TRIGger:OUTPut<[1]...4>:DELay:MINimum			Query only
[SOURce<[1]>:]BB:WLAN:TRIGger:OUTPut<[1]...4>:MODE	REStArt   FRAMe   PULSe   PATtern   RATio		
[SOURce<[1]>:]BB:WLAN:TRIGger:OUTPut<[1]...4>:OFFTime	2 ... (2 <sup>24</sup> - 1) chips		
[SOURce<[1]>:]BB:WLAN:TRIGger:OUTPut<[1]...4>:ONTime	2 ... (2 <sup>24</sup> - 1) chips		
[SOURce<[1]>:]BB:WLAN:TRIGger:OUTPut<[1]...4>:PATtern	#B0,1...#B111..1,32		
[SOURce<[1]>:]BB:WLAN:TRIGger:OUTPut<[1]...4>:PULSe:DIVider	2 ... 1024		
[SOURce<[1]>:]BB:WLAN:TRIGger:OUTPut<[1]...4>:PULSe:FREQuency			Query only
[SOURce<[1]>:]BB:WLAN:TRIGger:RMODE			Query only
[SOURce<[1]>:]BB:WLAN:TRIGger:SLENgth	0 ... (2 <sup>32</sup> - 1) chips		
[SOURce<[1]>:]BB:WLAN:TRIGger:SLUNit	FRAMe   CHIP   SEQuence		
[SOURce<[1]>:]BB:WLAN:TRIGger:SOURce	EXtErnal   INtErnal   BEXtErnal   OBASeband		
[SOURce<[1]>:]BB:WLAN:TTIME	0 ... 1000.0 ns	s	
[SOURce<[1]>:]BB:WLAN:WAVEform:CREate			No query

## SOURce:WLAN - Primary Commands

### [SOURce<[1]|2>:]BB:WLAN:CLIPping:LEVel 0 ... 100 PCT

The command sets the limit for level clipping. This value indicates at what point the signal is clipped. It is specified as a percentage, relative to the highest level. 100% indicates that clipping does not take place.

Level clipping is activated with the command `SOUR:BB:WLAN:CLIP:STAT ON`

**Example:** `"BB:WLAN:CLIP:LEV 80PCT"`  
 'sets the limit for level clipping to 80% of the maximum level.  
`"BB:WLAN:CLIP:STAT ON"`  
 'activates level clipping.

*RST value	Resolution	Options	SCPI
100 PCT	1	B10/B11 and B13 K48 SOURce2 only with second option B9/B10/B11	Device-specific

### [SOURce<[1]|2>:]BB:WLAN:CLIPping:MODE VECTor | SCALar

The command sets the method for level clipping (Clipping).

**Parameters:** **VECTor**  
 The reference level is the amplitude  $|i+jq|$

**SCALar**  
 The reference level is the absolute maximum of the I and Q values.

**Example:** `"BB:WLAN:CLIP:MODE SCAL"`  
 'selects the absolute maximum of all the I and Q values as the reference level.  
`"BB:WLAN:CLIP:LEV 80PCT"`  
 'sets the limit for level clipping to 80% of this maximum level.  
`"BB:WLAN:CLIP:STAT ON"`  
 'activates level clipping.

*RST value	Resolution	Options	SCPI
VECTor	-	B10/B11 and B13 K48 SOURce2 only with second option B9/B10/B11	Device-specific

[SOURce<[1]|2>:]BB:WLAN:CLIPping:STATe ON | OFF

The command activates level clipping (Clipping). The value is defined with the command [SOURce:]BB:WLAN:CLIPping:LEVel, the mode of calculation with the command [SOURce:]BB:WLAN:CLIPping:MODE .

**Example:** "BB:WLAN:CLIP:STAT ON"  
'activates level clipping.

*RST value	Resolution	Options	SCPI
OFF		B10/B11 and B13 K48 SOURce2 only with second option B9/B10/B11	Device-specific

[SOURce<[1]|2>:]BB:WLAN:CLOCK:MODE CHIP | MCHip

The command enters the type of externally supplied clock (:BB:WLAN:CLOCK:SOURCE EXTERNAL).

When MCHip is used, a multiple of the chip clock is supplied via the CLOCK connector and the chip clock is derived internally from this. The multiplier is entered with the command :BB:WLAN:CLOCK:MULTIPLIER.

With this command the only numerical suffix allowed for SOURce is 1, since the external clock source is permanently allocated to path A.

**Example:** "BB:WLAN:CLOCK:MODE CHIP"  
'selects clock type **Chip**, i.e. the supplied clock is a chip clock.

*RST value	Resolution	Options	SCPI
CHIP	-	B10/B11 and B13 K48 SOURce2 only with second option B9/B10/B11	Device-specific

[SOURce<[1]|2>:]BB:WLAN:CLOCK:MULTIPLIER 1 ... 64

The command specifies the multiplier for clock type **Multiplied** (:BB:WLAN:CLOCK:MODE MCHIP) in the case of an external clock source.

With this command the only numerical suffix allowed for SOURce is 1, since the external clock source is permanently allocated to path A.

**Example:** "BB:WLAN:CLOCK:SOURCE EXT"  
'selects the external clock source. The clock is supplied via the CLOCK connector.  
  
"BB:WLAN:CLOCK:MODE MCHIP"  
'selects clock type **Multiplied**, i.e. the supplied clock has a rate which is a multiple of the chip rate.  
  
"BB:WLAN:CLOCK:MULT 12"  
'the multiplier for the external clock rate is 12.

*RST value	Resolution	Options	SCPI
4	1	B10/B11 and B13 K48 SOURce2 only with second option B9/B10/B11	Device-specific

[SOURce<[1]|2>:]BB:WLAN:CLOCK:SOURce INTernal | EXTernal

The command selects the clock source.

Selecting EXTernal is only possible for path A, since the external clock source is permanently allocated to path A.

**Parameter:**       **INTernal**  
                             The internal clock reference is used.

**EXTernal**  
                             The external clock reference is supplied to the CLOCK connector.

**Example:**           "BB:WLAN:CLOCK:MODE CHIP"  
                             'specifies that a chip clock is supplied via the CLOCK connector.

*RST value	Resolution	Options	SCPI
INTernal	-	B10/B11 and B13 K48 SOURce2 only with second option B9/B10/B11	Device-specific

[SOURce<[1]|2>:]BB:WLAN:CRATe:VARiation 1 kcps ... 100 Mcps

The command enters the output chip rate.

**Example:**           "BB:WLAN:CRAT:VAR 4086001"  
                             "sets the output chip rate to 4.08 Mcps.

*RST value	Resolution	Options	SCPI
802.11a: 20 Mcps 802.11b: 11 Mcps 802.11g: 11 Mcps	1 Hz	B10/B11 and B13 K48 SOURce2 only with second option B9/B10/B11	Device-specific

**[SOURce:]BB:WLAN:FFORmat DATA | RTS | CTS | ACK**

The command selects the frame type. The selection defines parameters of the MAC layer, e.g. the values of the MAC Header bit fields. The command is only valid in framed mode (SOURce:BB:WLAN:SMODE FRAMed).

- Parameter: DATA**  
Predefined settings for data transmission.
- RTS**  
Predefined settings for Request to Send.
- CTS**  
Predefined settings for Clear to Send.
- ACK**  
Predefined settings for Acknowledgement.

**Example:** "BB:WLAN:SMODE FRAM"  
'selects framed mode  
  
"BB:WLAN:FFOR RTS"  
'selects frame type RTS

*RST value	Resolution	Options	Dependencies	SCPI
DATA	-	B10/B11 and B13 K48 SOURce2 only with second option B9/B10/B11	The selection defines parameters of the MAC layer, e.g. the values of the MAC Header bit fields	Device-specific

**[SOURce<[1]2>:]BB:WLAN:FILTer:PARAMeter:APCO25 0.05 ... 0.99**

The command sets the roll-off factor for filter type APCO25.

**Example:** "BB:WLAN:PAR:APCO25 0.2"  
'sets the roll-off factor to 0.2 for filter type APCO25.

*RST value	Resolution	Options	SCPI
0.20	0.01	B10/B11 and B13 K48 SOURce2 only with second option B9/B10/B11	Device-specific

**[SOURce<[1]2>:]BB:WLAN:FILTer:PARAMeter:COSSine 0.05 ... 0.99**

The command sets the roll-off factor for the Cosine filter type.

**Example:** "BB:WLAN:PAR:COS 0.35"  
'sets the roll-off factor to 0.35 for filter type Cosine.

*RST value	Resolution	Options	SCPI
0.35	0.01	B10/B11 and B13 K48 SOURce2 only with second option B9/B10/B11	Device-specific

[SOURce<[1]|2>:]BB:WLAN:FILTer:PARAmeter:PGAuss 0.15 ... 2.5

The command sets the roll-off factor for the Pure Gauss filter type.

**Example:** "BB:WLAN:FILT:PAR:GAUS 0.5"  
 'sets B x T to 0.5 for the Pure Gauss filter type.

*RST value	Resolution	Options	SCPI
0.5	0.01	B10/B11 and B13 K48 SOURce2 only with second option B9/B10/B11	Device-specific

[SOURce<[1]|2>:]BB:WLAN:FILTer:PARAmeter:GAUSs 0.15 ... 2.5

The command sets the roll-off factor for the Gauss filter type.

**Example:** "BB:WLAN:PAR:COS 0.5"  
 'sets B x T to 0.5 for the Gauss filter type.

*RST value	Resolution	Options	SCPI
0.5	0.01	B10/B11 and B13 K48 SOURce2 only with second option B9/B10/B11	Device-specific

[SOURce<[1]|2>:]BB:WLAN:FILTer:PARAmeter:RCOSine 0.05 ... 0.99

The command sets the roll-off factor for the Root Cosine filter type.

**Example:** "BB:WLAN:PAR:RCOS 0.22"  
 'sets the roll-off factor to 0.22 for filter type Root Cosine.

*RST value	Resolution	Options	SCPI
0.22	0.01	B10/B11 and B13 K48 SOURce2 only with second option B9/B10/B11	Device-specific

[SOURce<[1]|2>:]BB:WLAN:FILTer:PARAmeter:SPHase 0.15 ... 2.5

The command sets B x T for the Split Phase filter type.

**Example:** "BB:WLAN:PAR:SPH 0.5"  
 'sets B x T to 0.5 for the Split Phase filter type.

*RST value	Resolution	Options	SCPI
2.00	0.01	B10/B11 and B13 K48 SOURce2 only with second option B9/B10/B11	Device-specific

**[SOURce<[1]|2>:]BB:WLAN:FILTer:TYPE** RCOSine | COSine | GAUSSs | LGAuss | CONE | COF705 | COEqualizer | COFequalizer | C2K3x | APCO25 | SPHase | RECTangle | PGAuss

The command selects the filter type. The filter types are described in Chapter 4, Section "[Custom Dig Mod](#)".

**Example:**           "BB:WLAN:FILT:TYPE COS"  
                          'sets the filter type COSine.

*RST value	Resolution	Options	SCPI
Depends on layer mode	-	B10/B11 and B13 K48 SOURce2 only with second option B9/B10/B11	Device-specific

**[SOURce:]BB:WLAN:ILEaver:STATe** ON | OFF

The command activates/deactivates the interleaver. This command is only available in physical layer mode OFDM (SOURce:BB:WLAN:MODE OFDM).

**Example:**           "BB:WLAN:STAN STAN80211g"  
                          'selects standard 802.11g.  
  
                          "BB:WLAN:MODE OFDM"  
                          'selects physical layer mode OFDM.  
  
                          "BB:WLAN:ILE ON"  
                          'activates the interleaver.

*RST value	Resolution	Options	SCPI
ON	-	B10/B11 and B13 K48 SOURce2 only with second option B9/B10/B11	Device-specific

**[SOURce:]BB:WLAN:ITIMe** 0 ... 0.01 s

The command sets the idle time, i.e. the time between two PPDU bursts. This command is only available for framed mode (SOURce:BB:WLAN:SMODE FRAMed).

**Example:**           "BB:WLAN:ITIM 10us"  
                          'sets an idle time of 10 us.

*RST value	Resolution	Options	SCPI
100 us	1 us	B10/B11 and B13 K48 SOURce2 only with second option B9/B10/B11	Device-specific



**[SOURce<[1]>:]BB:WLAN:MODE OFDM | CCK | PBCC**

The command selects the Physical Layer Mode.

**Parameter: OFDM**

The OFDM (orthogonal frequency division multiplexing) physical layer supports a frame-based transmission. The OFDM (orthogonal frequency division multiplexing) signal is divided into 52 carriers. The symbol rate of the modulation on the individual carriers is 250 kHz. A user data rate of up to 54 Mbps at a channel bandwidth of 20 MHz can be obtained by combining 48 useful carriers for data transmission (4 carriers are used for pilots) and using 64QAM for subcarrier modulation. With OFDM, the individual carriers are superimposed mutually orthogonal, which, in the ideal case, does not cause any intercarrier interference (ICI).

**CCK**

The CCK (complementary code keying) physical layer mode is used for the 5.5 Mbps and 11 Mbps data rates.

**PBCC**

The PBCC (packet binary convolutional coding) physical layer can optionally be used instead of CCK modulation.

**Example:** "BB:WLAN:MODE OFDM"  
'selects physical layer mode OFDM.

*RST value	Resolution	Options	SCPI
OFDM	-	B10/B11 and B13 K48 SOURce2 only with second option B9/B10/B11	Device-specific

**[SOURce<[1]>:]BB:WLAN:PLCP:FORMat LONG | SHORT**

The command selects the packet type (PPDU format) with long or short PLCP (physical layer convergence protocol). Depending on the format selected, the structure, modulation and data rate of the PLCP preamble and header are modified. The command is only available in framed mode (SOURce:BB:WLAN:SMODE FRAMed) and for physical layer mode CCK and PBCC (SOURce:BB:WLAN:MODE CCK|PBCC).

**Example:** "BB:WLAN:PLCP:FORM LONG"  
'selects the packet type (PPDU format) with long PLCP.

*RST value	Resolution	Options	SCPI
LONG	-	B10/B11 and B13 K48 SOURce2 only with second option B9/B10/B11	Device-specific

[SOURce<[1]>:]BB:WLAN:PLCP:LCBit:STATe ON | OFF

The command sets the Locked Clock Bit in Service Field of the PLCP Header. The command is only available in framed mode (SOURce:BB:WLAN:SMOD FRAMed) and for physical layer mode CCK and PBCC (SOURce:BB:WLAN:MODE CCK|PBCC).

**Example:** "BB:WLAN:PLCP:LCB:STAT OFF"  
'disables the Locked Clock Bit.

*RST value	Resolution	Options	SCPI
ON	-	B10/B11 and B13 K48 SOURce2 only with second option B9/B10/B11	Device-specific

[SOURce<[1]>:]BB:WLAN:PRESet

The command produces a standardized default for the IEEE 802.11a-g standard. The settings correspond to the \*RST values specified for the commands.

This command triggers an action and therefore has no \*RST value and no query form.

**Example:** "BB:WLAN:PRES"  
'resets all the IEEE 802.11a-g settings to default values.

*RST value	Resolution	Options	Dependencies	SCPI
-	-	B10/B11 and B13 K48 SOURce2 only with second option B9/B10/B11	All IEEE 802.11a-g settings are preset. An overview is provided by Table in Chapter 4 (see Set to Default).	Device-specific

**[SOURce<[1]>:]BB:WLAN:SCRambler:MODE** OFF | RANDom | USER (OFDM) OFF | ON | PONLy (CCK / PBCC)

The command activates/deactivates the scrambler and selects the mode of determining the initialization value. The valid parameters depend on the selected physical layer mode (SOURce:BB:WLAN:MODE OFDM | CCK|PBCC).

**Parameter: OFF**  
The scrambler is deactivated.

**RANDom**  
(OFDM only) The scrambler is activated. The initialization value of the scrambler is selected at random. Each frame has a different random initialization value. This value is also different in case of successive recalculations with the same setting parameters so that different signals are generated for each calculation.

**USER**  
(OFDM only) The scrambler is activated. The initialization value of the scrambler is set to a fixed value that is entered at **Scrambler Init (hex)** . This value is then identical in each generated frame.

**ON**  
(CCK | PBCC only) The scrambler is activated.

**PONLy**  
(CCK | PBCC only) The scrambler is activated. Only the data of the preamble is scrambled.

**Example:** "BB:WLAN:SCR OFF"  
'the scrambler is deactivated.

*RST value	Resolution	Options	SCPI
OFDM: RANDom CCK/PBCC: ON	-	B10/B11 and B13 K48 SOURce2 only with second option B9/B10/B11	Device-specific

**[SOURce<[1]>:]BB:WLAN:SCRambler:PATTern** #H0,0 ... #HFF,8

The command enters the initialization value for scrambling mode User. This value is then identical in each generated frame. The command is only available for physical layer mode OFDM (SOURce:BB:WLAN:MODE OFDM)

**Example:** "BB:WLAN:SCR USER"  
'the scrambler is activated.  
"BB:WLAN:SCR:PATT #H3F,8"  
'the initialization value is set.

*RST value	Resolution	Options	SCPI
#H0,0	-	B10/B11 and B13 K48 SOURce2 only with second option B9/B10/B11	Device-specific

[SOURce<[1]|2>:]BB:WLAN:SERVice:PATtern #H0,0 ... #HFF,8

The command enters the value for service field The command is only available for physical layer mode OFDM (SOURce:BB:WLAN:MODE OFDM)

**Example:** "BB:WLAN:SERV:PATT #H3F,8"  
'the value for the service field is set.

*RST value	Resolution	Options	SCPI
#H0,0	-	B10/B11 and B13 K48 SOURce2 only with second option B9/B10/B11	Device-specific

[SOURce<[1]|2>:]BB:WLAN:SEQuence AUTO | RETRigger | AAUTo | ARETrigger | SINGLE

The command selects the trigger mode.

**Parameter: AUTO**  
The modulation signal is generated continuously.

**RETRigger**  
The modulation signal is generated continuously. A trigger event (internal or external) causes a restart.

**AAUTo**  
The modulation signal is generated only when a trigger event occurs. After the trigger event the signal is generated continuously. Signal generation is stopped with command SOUR:BB:WLAN:TRIG:ARM:EXEC and started again when a trigger event occurs.

**ARETrigger**  
The modulation signal is generated only when a trigger event occurs. The device automatically toggles to RETRIG mode. Every subsequent trigger event causes a restart.  
Signal generation is stopped with command SOUR:BB:WLAN:TRIG:ARM:EXEC and started again when a trigger event occurs.

**SINGLE**  
The modulation signal is generated only when a trigger event occurs. Then the signal is generated once to the length specified with command SOUR:BB:WLAN:TRIG:SLen. Every subsequent trigger event causes a restart.

**Example:** "BB:WLAN:SEQ AAUT"  
'sets the **Armed\_auto** trigger mode; the device waits for the first trigger (e.g. with \*TRG) and then generates the signal continuously.

*RST value	Resolution	Options	SCPI
AUTO	-	B10/B11 and B13 K48 SOURce2 only with second option B9/B10/B11	Device-specific

**[SOURce<[1]>:]BB:WLAN:SETTing:CATalog?**

This command reads out the files with IEEE 802.11a-g settings in the default directory. The default directory is set using command `MMEM:CDIRectory`. A path can also be specified, in which case the files in the specified directory are read. Only files with the file extension `*.wlan` will be listed.

The command is a query command and therefore has no \*RST value.

**Example:**           `"MMEM:CDIR 'D:\user\wlan"`  
                           `'sets the default directory to D:\user\wlan.`

`"BB:WLAN:SETT:CAT?"`  
                           `'reads out all the files with IEEE 802.11a-g settings in the default directory.`

**Response:** `"'wlana', 'wlang'"`  
                           `'the files 'wlana' and 'wlang' are available.`

*RST value	Resolution	Options	SCPI
	-	B10/B11 and B13 K48 SOURce2 only with second option B9/B10/B11	Device-specific

**[SOURce<[1]>:]BB:WLAN:SETTing:DELete <file\_name>**

This command deletes the selected file with IEEE 802.11a-g WLAN settings. The directory is set using command `MMEM:CDIRectory`. A path can also be specified, in which case the files in the specified directory are read. The file extension may be omitted. Only files with the file extension `*.wlan` will be deleted.

This command triggers an event and therefore has no \*RST value and no query form.

**Example:**           `"BB:WLAN:SETT:DEL 'wlana'"`  
                           `'deletes file 'wlana'.`

*RST value	Resolution	Options	SCPI
	-	B10/B11 and B13 K48 SOURce2 only with second option B9/B10/B11	Device-specific

**[SOURce<[1]>:]BB:WLAN:SETTing:LOAD <file\_name>**

This command loads the selected file with IEEE 802.11a-g WLAN settings. The directory is set using command `MMEM:CDIRectory`. A path can also be specified, in which case the files in the specified directory are read. The file extension may be omitted. Only files with the file extension `*.wlan` will be loaded.

This command triggers an event and therefore has no \*RST value and no query form.

**Example:**           `"BB:WLAN:SETT:LOAD 'wlana'"`  
                           `'loads file 'wlana'.`

*RST value	Resolution	Options	SCPI
	-	B10/B11 and B13 K48 SOURce2 only with second option B9/B10/B11	Device-specific

[SOURce<[1]|2>:]BB:WLAN:SETTing:STORe <file\_name>

This command stores the current IEE 802.11a-g WLAN settings into the selected file. The directory is set using command MMEM:CDIRectory. A path can also be specified, in which case the files in the specified directory are read. Only the file name has to be entered. IEE 802.11a-g WLAN settings are stored as files with the specific file extensions \*.wlan.

This command triggers an event and therefore has no \*RST value and no query form.

**Example:** "BB:WLAN:SETT:STOR 'wlan\_g'"  
'stores the current settings into file 'wlan\_g'.

*RST value	Resolution	Options	SCPI
	-	B10/B11 and B13 K48 SOURce2 only with second option B9/B10/B11	Device-specific

[SOURce<[1]|2>:]BB:WLAN:SLENgth 1 ... 511 frames

The command selects the number of frames. The command is only valid in framed mode (SOURce:BB:WLAN:SMODE FRAMed).

**Example:** "BB:WLAN:SLEN 4"  
'selects the generation of 4 frames.

*RST value	Resolution	Options	SCPI
1	-	B10/B11 and B13 K48 SOURce2 only with second option B9/B10/B11	Device-specific

[SOURce<[1]|2>:]BB:WLAN:SMODE FRAMed | UNFRamed

The command selects the simulation mode.

**Parameter:** **FRAMed**

The **framed mode** is the standard operating mode which is also used in the real system. Data packets with the frame structure defined by the standard are generated.

**UNFRamed**

The **unframed mode** is offered in addition. In this mode, a non-packet-oriented signal without a frame structure is generated with the modulations and data rates defined by 802.11a-g.

**Example:** "BB:WLAN:SMOD UNFR"  
'selects unframed mode.

*RST value	Resolution	Options	SCPI
FRAMed	-	B10/B11 and B13 K48	Device-specific

[SOURce<[1]|2>:]BB:WLAN:STANdard STAN80211A | STAN80211B | STAN80211G

The command selects the standard according to which the signal is simulated.

**Parameter:** STAN80211A  
 The standard supports OFDM (orthogonal frequency division multiplexing). This modulation is defined by the IEEE 802.11a specification in the 5 GHz frequency band.

STAN80211B  
 The standard includes the modulation mode CCK (complementary code keying) and the data rates 5.5 Mbps and 11 Mbps. PBCC (packet binary convolutional coding) can optionally be used instead of CCK modulation for the 5.5 Mbps and 11 Mbps data rates.

STAN80211G  
 Standard 802.11g extends standard 802.11b with higher transmission rates. 802.11g contains the previous 802.11b modes and also integrates the OFDM method used in 802.11a for frequencies in the 2.4 GHz band.

**Example:** "BB:WLAN:STAN STAN80211B"  
 'selects signal generation according to 802.11b.

*RST value	Resolution	Options	SCPI
STAN80211G	-	B10/B11 and B13 K48 SOURce2 only with second option B9/B10/B11	Device-specific

[SOURce<[1]|2>:]BB:WLAN:STATe ON | OFF

The command activates modulation in accordance with the IEE 802.11a-g WLAN standard. Activating this standard deactivates all the other digital standards and digital modulation modes on the same path.

**Example:** "BB:WLAN:STAT ON"  
 'activates modulation in accordance with the IEE 802.11a-g WLAN standard.

*RST value	Resolution	Options	Dependencies	SCPI
OFF	-	B10/B11 and B13 K48 SOURce2 only with second option B9/B10/B11	BB:WLAN:STAT ON deactivates the other standards and digital modulation.	Device-specific

[SOURce<[1]2>:]BB:WLAN:TDWindowing:STATe ON | OFF

The command activates/deactivates the time domain windowing. Time domain windowing is a method to influence the spectral characteristics of the signal, which is not stipulated by the standard. However, it does not replace oversampling and subsequent signal filtering. The command is only available for physical layer mode OFDM (SOURce:BB:WLAN:MODE OFDM).

**Example:** "BB:WLAN:TDW:STAT OFF"  
'deactivates the time domain windowing.

*RST value	Resolution	Options	SCPI
OFF		B10/B11 and B13 K48 SOURce2 only with second option B9/B10/B11	Device-specific

[SOURce<[1]2>:]BB:WLAN:TRIGger:ARM:EXECute

The command stops signal generation for trigger modes Armed\_Auto and Armed\_Retrigger. A subsequent internal or external trigger event restart signal generation.

This command triggers an event and therefore has no \*RST value and no query form.

**Example:** "BB:WLAN:TRIG:SOUR INT"  
'sets internal triggering.

"BB:WLAN:TRIG:SEQ ARET"  
'sets Armed\_Retrigger mode, i.e. every trigger event causes signal generation to restart.

"BB:WLAN:TRIG:EXEC"  
'executes a trigger, signal generation is started.

"BB:WLAN:TRIG:ARM:EXEC"  
'signal generation is stopped.

"BB:WLAN:TRIG:EXEC"  
'executes a trigger, signal generation is started again.

*RST value	Resolution	Options	SCPI
		B10/B11 and B13 K48 SOURce2 only with second option B9/B10/B11	Device-specific



**[SOURce<[1]|2>:]BB:WLAN:TRIGger:EXECute**

The command executes a trigger. The internal trigger source must be selected using the command :BB:WLAN:TRIG:SOUR INT and a trigger mode other than AUTO must be selected using the command :BB:WLAN:TRIG:SEQ.

This command triggers an event and therefore has no \*RST value and no query form.

**Example:** "BB:WLAN:TRIG:SOUR INT"  
 'sets internal triggering.  
 "BB:WLAN:TRIG:SEQ RETR"  
 'sets Retrigger mode, i.e. every trigger event causes signal generation to restart.  
 "BB:WLAN:TRIG:EXEC"  
 'executes a trigger.

*RST value	Resolution	Options	SCPI
		B10/B11 and B13 K48 SOURce2 only with second option B9/B10/B11	Device-specific

**[SOURce<[1]|2>:]BB:WLAN:TRIGger[:EXTErnal<[1]|2>]:DELay 0 ... 2^32-1**

The command specifies the trigger delay (expressed as a number of chips) for external triggering. The numeric suffix to EXTErnal distinguishes between the external trigger via the TRIGGER 1 (suffix 1) and TRIGGER 2 (suffix 2) connector.

**Example:** "BB:WLAN:TRIG:SOUR EXT"  
 'sets an external trigger via the TRIGGER 1 connector.  
 "BB:WLAN:TRIG:DEL 50"  
 'sets a delay of 50 chips for the trigger.

*RST value	Resolution	Options	SCPI
0 chips	1 chip	B10/B11 and B13 K48 SOURce2 only with second option B9/B10/B11	Device-specific

[SOURce<[1]|2>:]BB:WLAN:TRIGger[:EXTErnal<[1]|2>]:INHibit 0 ... 2^32-1

The command specifies the number of chips by which a restart is to be inhibited following a trigger event. This command applies only in the case of external triggering. The numeric suffix to EXTErnal distinguishes between the external trigger via the TRIGGER 1 (suffix 1) and TRIGGER 2 (suffix 2) connector.

**Example:** "BB:WLAN:TRIG:SOUR EXT"  
 'selects an external trigger via the TRIGGER 1 connector.  
 "BB:WLAN:TRIG:INH 200"  
 'sets a restart inhibit for 200 chips following a trigger event.

*RST value	Resolution	Options	SCPI
0 chips	1 chip	B10/B11 and B13 K48 SOURce2 only with second option B9/B10/B11	Device-specific

[SOURce<[1]|2>:]BB:WLAN:TRIGger:OBASband:DELay 0 ... 2^32-1

The command specifies the trigger delay (expressed as a number of chips) for triggering by the trigger signal from the second path (two-path instruments only).

**Example:** "BB:WLAN:TRIG:SOUR OBAS"  
 'sets for path A the internal trigger executed by the trigger signal from the second path (path B).  
 "BB:WLAN:TRIG:OBAS:DEL 50"  
 'sets a delay of 50 chips for the trigger.

*RST value	Resolution	Options	SCPI
0 chips	1 chips	B10/B11 and B13 K48 Only with second option B13	Device-specific

[SOURce<[1]|2>:]BB:WLAN:TRIGger:OBASband:INHibit 0 ... 2^32-1

The command specifies the number of chips by which a restart is to be inhibited following a trigger event. This command applies only for triggering by the second path (two-path instruments only).

**Example:** "BB:WLAN:TRIG:SOUR OBAS"  
 'sets for path A the internal trigger executed by the trigger signal from the second path (path B).  
 "BB:WLAN:TRIG:INH 200"  
 'sets a restart inhibit for 200 chips following a trigger event.

*RST value	Resolution	Options	SCPI
0 chips	1 chip	B10/B11 and B13 K48 Only with second option B13	Device-specific

[SOURce<[1]>:]BB:WLAN:TRIGger:OUTPut<[1]...4>:DELay 0 ... 2<sup>32</sup> - 1 Samples

The command defines the delay between the signal on the marker outputs and the start of the signal, expressed in terms of chips. Command :BB:WLAN:TRIGger:OUTPut:DELay:FIXed can be used to restrict the range of values to the dynamic range, i.e. the range within which a delay of the marker signals can be set without restarting the marker and signal.

**Example:** "BB:WLAN:TRIG:OUTP2:DEL 1600"  
 'sets a delay of 1600 chips for the signal on connector MARKER 2.

*RST value	Resolution	Options	SCPI
0	1 chip	B10/B11 and B13 K48 SOURce2 only with second option B9/B10/B11	Device-specific

[SOURce<[1]>:]BB:WLAN:TRIGger:OUTPut:DELay:FIXed ON | OFF

The command restricts the marker delay setting range to the dynamic range. In this range the delay can be set without restarting the marker and signal. If a delay is entered in setting ON but is outside this range, the maximum possible delay is set and an error message is generated.

**Example:** "BB:WLAN:TRIG:OUTP:DEL:FIX ON"  
 'restricts the marker signal delay setting range to the dynamic range.

*RST value	Resolution	Options	SCPI
OFF	-	B10/B11 and B13 K48 SOURce2 only with second option B9/B10/B11	Device-specific

[SOURce<[1]>:]BB:WLAN:TRIGger:OUTPut<[1]...4>:DELay:MAXimum

The command queries the maximum marker delay for setting :BB:WLAN:TRIG:OUTP:DEL:FIX ON.

The command is a query only and therefore has no \*RST value.

**Example:** "BB:WLAN:TRIG:OUTP:DEL:FIX ON"  
 'restricts the marker signal delay setting range to the dynamic range.

"BB:WLAN:TRIG:OUTP:DEL:MAX"  
 'queries the maximum of the dynamic range.

Response: "2000"  
 'the maximum for the marker delay setting is 2000 chips.

*RST value	Resolution	Options	SCPI
-	-	B10/B11 and B13 K48 SOURce2 only with second option B9/B10/B11	Device-specific

**[SOURce<[1]|2>:]BB:WLAN:TRIGger:OUTPut<[1]...4>:DELay:MINimum**

The command queries the minimum marker delay for setting :BB:WLAN:TRIGger:OUTPut:DELay:FIXed ON. The command is a query only and therefore has no \*RST value.

**Example:** "BB:WLAN:TRIG:OUTP:DEL:FIX ON"  
'restricts the marker signal delay setting range to the dynamic range.

"BB:WLAN:TRIG:OUTP:DEL:MIN"  
'queries the minimum of the dynamic range.

Response: "0"  
'the minimum for the marker delay setting is 0 chips.

*RST value	Resolution	Options	SCPI
-	-	B10/B11 and B13, K48, SOURce2 only with second option B9/B10/B11	Device-specific

**[SOURce<[1]|2>:]BB:WLAN:TRIGger:OUTPut<[1]...4>:MODE RESTart | FRAMe | FAPart | PULSe | PATTern | RATio**

The command defines the signal for the selected marker output.

**Parameter: RESTart**  
A marker signal is generated at the start of each signal sequence (period = selected number of frames; the sequence length is set with command SOUR:BB:WLAN:FCOunt).

**FRAMe**  
A marker signal is generated at the start of each frame (period = PPDU + idle time).

**FACTive**  
A marker signal is generated at the start of every active part of the frame. The active data transfer part (PPDU) of a frame period is marked with high, the inactive part (idle time) with low. This marker can be used to decrease the carrier leakage during inactive signal parts by feeding it into the pulse modulator.

**PATTern**  
A marker signal is generated according to the user defined pattern (command SOURce:BB:WLAN:TRIGger:OUTPut:PATTern).

**PULSe**  
A pulsed marker signal is generated. The pulse frequency (= symbol rate/divider) is defined with the SOUR:BB:WLAN:TRIG:OUTP:PULSe:DIVider command and can be queried with the SOUR:BB:WLAN:TRIG:OUTP:PULSe:FREQuency? command.

**RATio**  
A marker signal corresponding to the Time Off / Time On specifications in the commands SOURce:BB:WLAN:TRIGger:OUTPut:OFFT and SOURce:BB:WLAN:TRIGger:OUTPut:ONT is generated.

**Example:** "BB:WLAN:TRIG:OUTP2:MODE FRAM"  
'selects the frame marker signal on output MARKER 2.

*RST value	Resolution	Options	SCPI
RESTart	-	B10/B11 and B13, K48 , SOURce2 only with second option B9/B10/B11	Device-specific

**[SOURce<[1]|2>:]BB:WLAN:TRIGger:OUTPut<[1]...4>:OFFTime 1.. 2^24 - 1 (1..16 777 215) chips**

The command sets the number of chips in a period (ON time + OFF time) during which the marker signal in setting SOURce:BB:WLAN:TRIGger:OUTPut:MODE RATio on the marker outputs is OFF.

**Example:** "BB:WLAN:TRIG:OUTP2:OFFT 200"  
'sets an OFF time of 200 chips for marker signal 2 on path A.

*RST value	Resolution	Options	SCPI
1	1	B10/B11 and B13 K48 SOURce2 only with second option B9/B10/B11	Device-specific

**[SOURce<[1]|2>:]BB:WLAN:TRIGger:OUTPut<[1]...4>:ONTime 1.. 2^24 - 1 (1..16 777 215) chips**

The command sets the number of chips in a period (ON time + OFF time) during which the marker signal in setting SOURce:BB:WLAN:TRIGger:OUTPut:MODE RATio on the marker outputs is ON.

**Example:** "BB:WLAN:TRIG:OUTP2:ONT 200"  
'sets an ON time of 200 chips for marker 2 on path A.

*RST value	Resolution	Options	SCPI
1	1	B10/B11 and B13 K48 SOURce2 only with second option B9/B10/B11	Device-specific

**[SOURce<[1]|2>:]BB:WLAN:TRIGger:OUTPut<[1]...4>:PATTern #B0,1 ... #B111...1, 2**

The command defines the bit pattern used to generate the marker signal in the setting SOURce:BB:WLAN:TRIGger:OUTPut:MODE PATTern. 0 is marker off, 1 is marker on.

**Example:** "BB:WLAN:TRIG:OUTP2:PATT #B000000011111111,15"  
'sets a bit pattern.  
"BB:WLAN:TRIG:OUTP2:MODE PATT"  
'activates the marker signal according to a bit pattern on output MARKER 2.

*RST value	Resolution	Options	SCPI
#B,1	-	B10/B11 and B13 K48 SOURce2 only with second option B9/B10/B11	Device-specific

[SOURce<[1]|2>:]BB:WLAN:TRIGger:OUTPut<[1]...4>:PULSe:DIVider 2 ... 2^10

The command sets the divider for Pulse marker mode (SOUR:BB:WLAN:TRIG:OUTP:MODE PULSe). The resulting pulse frequency is derived by dividing the symbol rate by the divider.

**Example:** "BB:WLAN:TRIG:OUTP2:PULS:DIV 2"  
'sets the divider to 2 for the path A marker signal on output MARKER 2.

"BB:WLAN:TRIG:OUTP2:FREQ?"  
'queries the resulting pulse frequency of the marker signal.

Response: "66 000"  
'the resulting pulse frequency is 66 kHz.

*RST value	Resolution	Options	SCPI
2	1	B10/B11 and B13 K48 SOURce2 only with second option B9/B10/B11	Device-specific

[SOURce<[1]|2>:]BB:WLAN:TRIGger:OUTPut<[1]...4>:PULSe:FREQuency?

The command queries the pulse frequency of the pulsed marker signal in the setting SOURce:BB:WLAN:TRIGger:OUTPut:MODE PULSe. The pulse frequency is derived by dividing the symbol rate by the divider.

The command is a query command and therefore has no \*RST value.

**Example:** "BB:WLAN:TRIG:OUTP2:PULS:DIV 2"  
'sets the divider for the path A marker signal on output MARKER 2 to the value 2.

"BB:WLAN:TRIG:OUTP2:MODE PULS"  
'enables the pulsed marker signal.

"BB:WLAN:TRIG:OUTP2:PULS:FREQ?"  
'queries the pulse frequency of the marker signal.

Response: "33 000"  
'the resulting pulse frequency is 33 kHz.

*RST value	Resolution	Options	SCPI
-	-	B10/B11 and B13 K48 SOURce2 only with second option B9/B10/B11	Device-specific

**[SOURce<[1]|2>:]BB:WLAN:TRIGger:RMODE**

The command queries the current status of signal generation for all trigger modes with IEEE 802.11a-g WLAN modulation on.

The command is a query command and therefore has no \*RST value.

**Parameter:**       **RUN**

the signal is generated. A trigger event occurred in the triggered mode.

**STOP**

the signal is not generated. A trigger event did not occur in the triggered modes, or signal generation was stopped by the command

:BB:WLAN:TRIG:ARM:EXECute (armed trigger modes only).

**Example:**

"SOUR2:BB:WLAN:TRIG:SOUR EXT"

'sets external triggering via the TRIGGER 1 connector for path B of a two-path instrument.

"SOUR2:BB:WLAN:TRIG:MODE ARET"

'selects the Armed\_Retrigger mode.

"SOUR2:BB:WLAN:TRIG:RMODE?"

'queries the current status of signal generation.

Response: "RUN"

'the signal is generated, an external trigger was executed.

*RST value	Resolution	Options	SCPI
-	-	B10/B11 and B13 K48 SOURce2 only with second option B9/B10/B11	Device-specific

**[SOURce<[1]|2>:]BB:WLAN:TRIGger:SLENgth 1 ... (2<sup>32</sup>-1) chips**

The command defines the length of the signal sequence to be output in the **Single** trigger mode (SOUR:BB:WLAN:SEQ SING). The input is made in terms of chips.

It is possible to output deliberately just part of the frame, an exact sequence of the frame, or a defined number of repetitions of the frame.

**Example:**

"SOUR2:BB:WLAN:SEQ SING"

'sets trigger mode Single.

"SOUR2:BB:WLAN:TRIG:SLEN 200"

'sets a sequence length of 200 chips. The first 200 chips of the current frame will be output after the next trigger event.

*RST value	Resolution	Options	SCPI
32 768 chips	1 chip	B10/B11 and B13 K48 SOURce2 only with second option B9/B10/B11	Device-specific

[SOURce<[1]|2>:]BB:WLAN:TRIGger:SLUNit FRAME | CHIP | SEQUENCE

The command defines the unit for the entry of the length of the signal sequence (SOUR:BB:WLAN:TRIG:SLEN) to be output in the **Single** trigger mode (SOUR:BB:WLAN:SEQ SING).

**Parameter:**       **FRAME**  
                           Unit Frame. A single frame is generated after a trigger event.

**CHIP**  
                           Unit Chip. A single chip is generated after a trigger event.

**SEQUENCE**  
                           Unit Sequence Length. A single sequence is generated after a trigger event.

**Example:**       " SOUR:BB:WLAN:SEQ SING"  
                           'sets trigger mode Single.

                      " SOUR:BB:WLAN:TRIG:SLUN FRAM"  
                           'sets unit Frame for the entry of sequence length.

                      " SOUR:BB:WLAN:TRIG:SLEN 2"  
                           'sets a sequence length of 2 frame. Two frames will be output after the next trigger event.

*RST value	Resolution	Options	SCPI
SEQUENCE	-	B10/B11 and B13 K48 SOURce2 only with second option B9/B10/B11	Device-specific

[SOURce<[1]|2>:]BB:WLAN:TRIGger:SOURce INTERNAL | EXTERNAL | BEXTERNAL | OBASeband

The command selects the trigger source.

**Parameter:**       **INTERNAL**  
                           Triggering is executed by means of the Trigger command SOURce<[1]|2>:BB:WLAN:TRIGger:EXECute or \*TRG in the case of remote control and by means of **Execute Trigger** in the case of manual operation.

**EXTERNAL**  
                           Triggering is executed by means of the signal on the TRIGGER 1 connector.

**BEXTERNAL**  
                           Triggering is executed by means of the signal on the TRIGGER 2 connector.

**OBASeband**  
                           Triggering is executed by means of the trigger signal from the second path (two-path instruments only).

**Example:**       " SOUR2:BB:WLAN:TRIG:SOUR EXT"  
                           'sets external triggering via the TRIGGER 1 connector for path B of a two-path instrument.

*RST value	Resolution	Options	SCPI
INTERNAL	-	B10/B11 and B13 K48 SOURce2 only with second option B9/B10/B11	Device-specific



[SOURce<[1]|2>:]BB:WLAN:TTIMe 0 ... 1000 ns

The command sets the transition time. The transition time defines the overlap range of two OFDM symbols when time domain windowing is active. At a setting of 100 ns, one sample overlaps. This command is only available in physical layer mode OFDM (SOURce:BB:WLAN:MODE OFDM) and with active time domain windowing (SOURce:BB:WLAN:TDWindowing:STATE ON).

**Example:** "BB:WLAN:TTIM 10 ns"  
 'sets a transition time of 10 ns.'

RST value	Resolution	Options	SCPI
100 ns	1 ns	B10/B11 and B13 K48 SOURce2 only with second option B9/B10/B11	Device-specific

## SOURce:WLAN - PSDU Settings

The SOURce:BB:WLAN:PSDU system contains commands for setting the characteristics of the data packet on the physical layer (PPDU).

Command	Parameters	Default unit	Comments
[SOURce<[1] 2>:]BB:WLAN:PSDU:BRATe	6MBPS   9MBPS   12MBPS   18MBPS   24MBPS   36MBPS   48MBPS   54MBPS		
[SOURce<[1] 2>:]BB:WLAN:PSDU:BSPReading:STATe	ON   OFF		
[SOURce<[1] 2>:]BB:WLAN:PSDU:DATA	PN9   PN15   PN16   PN20   PN21   PN23   ZERO   ONE   PATTern   DLISt		
[SOURce<[1] 2>:]BB:WLAN:PSDU:DATA:DSElect	<dlist_name>		
[SOURce<[1] 2>:]BB:WLAN:PSDU:DATA:PATTern	#B0,1...B11..1, 64		
[SOURce<[1] 2>:]BB:WLAN:PSDU:DLENgth	4095 (Framed), 10000 (Unframed)	bytes	
[SOURce<[1] 2>:]BB:WLAN:PSDU:MAC:ADDRes<1 2 3 4>	#H0000 0000 0000,48 ... #FFFFFFFF FFF,48		
[SOURce<[1] 2>:]BB:WLAN:PSDU:MAC:ADDRes<1 2 3 4>:STATe	ON   OFF		
[SOURce<[1] 2>:]BB:WLAN:PSDU:MAC:DID	#H0000,16 ... #HFFFF,16		
[SOURce<[1] 2>:]BB:WLAN:PSDU:MAC:FCONtrol	#H0000,16 ... #HFFFF,16		
[SOURce<[1] 2>:]BB:WLAN:PSDU:MAC:FCONtrol:FDS	#H0,1 ... #H1,1		
[SOURce<[1] 2>:]BB:WLAN:PSDU:MAC:FCONtrol:MDATa	#H0,1 ... #H1,1		
[SOURce<[1] 2>:]BB:WLAN:PSDU:MAC:FCONtrol:MFRagments	#H0,1 ... #H1,1		
[SOURce<[1] 2>:]BB:WLAN:PSDU:MAC:FCONtrol:ORDer	#H0,1 ... #H1,1		
[SOURce<[1] 2>:]BB:WLAN:PSDU:MAC:FCONtrol:PMANagement	#H0,1 ... #H1,1		
[SOURce<[1] 2>:]BB:WLAN:PSDU:MAC:FCONtrol:PVERsion	#H0,1 ... #H1,1		
[SOURce<[1] 2>:]BB:WLAN:PSDU:MAC:FCONtrol:RETRy	#H0,1 ... #H1,1		
[SOURce<[1] 2>:]BB:WLAN:PSDU:MAC:FCONtrol:SUBTye	#H0,1 ... #H1,1		
[SOURce<[1] 2>:]BB:WLAN:PSDU:MAC:FCONtrol:TDS	#H0,1 ... #H1,1		
[SOURce<[1] 2>:]BB:WLAN:PSDU:MAC:FCONtrol:TYPE	#H0,2 ... #H3,2		
[SOURce<[1] 2>:]BB:WLAN:PSDU:MAC:FCONtrol:WEP	#H0,1 ... #H1,1		
[SOURce<[1] 2>:]BB:WLAN:PSDU:MAC:FCSequence:STATe	ON   OFF		
[SOURce<[1] 2>:]BB:WLAN:PSDU:MAC:SCONtrol:FRAGment:INCRement	0 ... 1024		
[SOURce<[1] 2>:]BB:WLAN:PSDU:MAC:SCONtrol:FRAGment:STARt	#H0,1 ... #HF,4		
[SOURce<[1] 2>:]BB:WLAN:PSDU:MAC:SCONtrol:SEQuence:INCRement	0 ... 1024		
[SOURce<[1] 2>:]BB:WLAN:PSDU:MAC:SCONtrol:SEQuence:STARt	#H0,1 ... #HFFF,12		

Command	Parameters	Default unit	Comments
[SOURce<[1]]2>:]BB:WLAN:PSDU:MAC:SCONtrol:STATe	ON   OFF		
[SOURce<[1]]2>:]BB:WLAN:PSDU:MAC:STATe	ON   OFF		
[SOURce<[1]]2>:]BB:WLAN:PSDU:MODulation	BPSK   QPSK   QAM16   M64   DBPSK   DQPSK   CCK   PBCC		
[SOURce<[1]]2>:]BB:WLAN:PSDU:SCOunt	1...1378		

**[SOURce<[1]]2>:]BB:WLAN:PSDU:BRATe** 6MBPS | 9MBPS | 12MBPS | 18MBPS | 24MBPS | 36MBPS | 48MBPS | 54MBPS (OFDM) / 1MBPS | 2MBPS | 5.5MBPS | 11MBPS | 22MBPS (CCK|PBCC)

The command selects the bit rate of the PSDU. The available values depend on the selected physical layer mode. Value 1MBPS is available only for selection of long PLCP format in physical layer modes CCK and PBCC.

**Example:** "BB:WLAN:MODE"  
'selects physical layer mode OFDM.  
"BB:WLAN:PSDU:BRAT 12MBPS"  
'sets a bit rate of 12MBPS.

*RST value	Resolution	Options	SCPI
OFDM: 54MBPS CCK PBCC: 11MBPS	-	B10/B11 and B13 K48 SOURce2 only with second option B9/B10/B11	Device-specific

**[SOURce<[1]]2>:]BB:WLAN:PSDU:BSPrReading:STATe** ON | OFF

The command activates/deactivates barker spreading. The command is only available only for selection of bit rates 1MBPS or 2 MBPS in physical layer modes CCK and PBCC.

**Example:** "BB:WLAN:MODE CCK"  
'selects physical layer mode CCK.  
"BB:WLAN:PSDU:PLCP:FORM LONG"  
'selects long PLCP format.  
"BB:WLAN:PSDU:BRAT 1MBPS"  
'sets a bit rate of 1MBPS.  
"BB:WLAN:PSDU:BSPr OFF"  
'deactivates barker spreading.

*RST value	Resolution	Options	SCPI
ON	-	B10/B11 and B13 K48 SOURce2 only with second option B9/B10/B11	Device-specific

**[SOURce<[1]2>:]BB:WLAN:PSDU:DATA**

PN9 | PN15 | PN16 | PN20 | PN21 | PN23 | DLIS | ZERO | ONE | PATTern

The command determines the data source for the data field.

**Parameters: PNxx**

The pseudo-random sequence generator is used as the data source. Different random sequence lengths can be selected.

**DLIS**

A data list is used. The data list is selected with the command  
:BB:WLAN:PSDU:DATA:DSElect.

**ZERO | ONE**

Internal 0 and 1 data is used.

**PATTern**

Internal data is used. The bit pattern for the data is defined by the command  
:BB:WLAN:PSDU:DATA:PATTern.

**Example:**

```
"BB:WLAN:PSDU:DATA PATT"
'selects as the data source for the data fields of burst 0, the bit pattern defined
with the following command.

"BB:WLAN:PSDU:DATA:PATT #H3F,8"
'defines the bit pattern.
```

*RST value	Resolution	Options	SCPI
PN9	-	B10/B11 and B13 K48 SOURce2 only with second option B9/B10/B11	Device-specific

**[SOURce<[1]2>:]BB:WLAN:PSDU:DATA:DSElect <data list name>**

The command selects the data list for the DLIS data source selection.

The lists are stored as files with the fixed file extensions \*.dm\_iqd in a directory of the user's choice. The directory applicable to the following commands is defined with the command MMEMoRY:CDIR. To access the files in this directory, you only have to give the file name, without the path and the file extension.

**Example:**

```
"BB:WLAN:PSDU:DATA DLIS"
'selects the Data Lists data source.

"MMEM:CDIR 'D:\Lists\DM\IqData'"
'selects the directory for the data lists.

"BB:WLAN:PSDU:MAC:DATA:DLIS 'wlan_list1'"
'selects file 'wlan_list1' as the data source. This file must be in the directory
D:\Lists\DM\IqData and have the file extension *.dm_iqd.
```

*RST value	Resolution	Options	SCPI
-	-	B10/B11 and B13 K48 SOURce2 only with second option B9/B10/B11	Device-specific

[SOURce<[1]|2>:]BB:WLAN:PSDU:DATA:PATtern #B0,1... #B111..1,64

The command determines the bit pattern for the PATtern selection. The maximum length is 64 bits.

**Example:** "BB:WLAN:PSDU:MAC:DATA:PATT #H3F,8"  
'defines the bit pattern.

*RST value	Resolution	Options	SCPI
0	-	B10/B11 and B13 K48 SOURce2 only with second option B9/B10/B11	Device-specific

[SOURce<[1]|2>:]BB:WLAN:PSDU:DLEnGth 0 ... 4095 Bytes (Framed), 100000 Bytes (Unframed)

The command sets the data length in bytes. In the framed mode, data field lengths of up to 4095 bytes are possible. This corresponds to the maximum data length. The unframed mode offers a data length of up to 100000 bytes.

**Example:** "BB:WLAN:PSDU:DATA:LENG 256"  
'sets a data length of 256.

*RST value	Resolution	Options	Dependencies	SCPI
OFDM: 100 Bytes, CCK PBCC: 1024 Bytes	-	B10/B11 and B13 K48 SOURce2 only with second option B9/B10/B11	If the data field length is changed, the generator calculates the number of OFDM data symbols as a function of the set PSDU bit rate (SOUR:BB:WLAN:PSDU:SCO).	Device-specific

[SOURce<[1]|2>:]BB:WLAN:PSDU:MAC:ADDRess<1|2|3|4> #H000000000000,48 #HFFFFFFFFFFFFFF,48

The command enters the value of the address fields 1 ... 4. Exactly 48 bits must be entered. Each address is 6 bytes (48 bit) long. The addresses can be entered in hexadecimal form in the entry field of each address field. The least significant byte (LSB) is in left notation.

The MAC header can only be configured in framed mode (SOURce:BB:WLAN:SMODE FRAMed)

**Example:** "BB:WLAN:PSDU:MAC:ADDR2 #H124836C7EA54,48"  
'set the value for address field 2.

*RST value	Resolution	Options	SCPI
#H000000000000,48		B10/B11 and B13 K48 SOURce2 only with second option B9/B10/B11	Device-specific

**[SOURce<[1]|2>:]BB:WLAN:PSDU:MAC:ADDRess<1|2|3|4>:STATe ON | OFF**

The command activates/deactivates the selected address field.

The MAC header can only be configured in framed mode (SOURce:BB:WLAN:SMODE FRAMed).

**Example:** "BB:WLAN:PSDU:MAC:ADDR2:STAT ON"  
'activates generation of address field 2.

*RST value	Resolution	Options	SCPI
OFF		B10/B11 and B13 K48 SOURce2 only with second option B9/B10/B11	Device-specific

**[SOURce<[1]|2>:]BB:WLAN:PSDU:MAC:DID #H0000,16 ... #HFFFF,16**

The command enters the value of the duration Id field. Depending on the frame type, the 2-byte field Duration/ID is used to transmit the association identity of the station transmitting the frame or it indicates the duration assigned to the frame type. Exactly 16 bit must be entered.

The MAC header can only be configured in framed mode (SOURce:BB:WLAN:SMODE FRAMed)

**Example:** "BB:WLAN:PSDU:MAC:FORM #HA5A5,16"  
'sets the value of the duration Id field.

*RST value	Resolution	Options	SCPI
#H0000,16	-	B10/B11 and B13 K48 SOURce2 only with second option B9/B10/B11	Device-specific

**[SOURce<[1]|2>:]BB:WLAN:PSDU:MAC:FCONtrol #H0000,16 ... #HFFFF,16**

The command enters the value of the frame control field. The Frame control field has a length of 2 bytes (16 bits) and is used to define the protocol version, the frame type and its function, etc.. As an alternative, the individual bits can be set with the following commands.

The MAC header can only be configured in framed mode (SOURce:BB:WLAN:SMODE FRAMed).

**Example:** "BB:WLAN:PSDU:MAC:FCON #H100A,16"  
'sets the value of the frame control field.

*RST value	Resolution	Options	SCPI
#H0000,16		B10/B11 and B13 K48 SOURce2 only with second option B9/B10/B11	Device-specific

```

[SOURce<[1]|2>:]BB:WLAN:PSDU:MAC:FCONtrol:FDS #H0,1 ... #H1,1
[SOURce<[1]|2>:]BB:WLAN:PSDU:MAC:FCONtrol:MDATa #H0,1 ... #H1,1
[SOURce<[1]|2>:]BB:WLAN:PSDU:MAC:FCONtrol:MFRagments #H0,1 ... #H1,1
[SOURce<[1]|2>:]BB:WLAN:PSDU:MAC:FCONtrol:ORDer #H0,1 ... #H1,1
[SOURce<[1]|2>:]BB:WLAN:PSDU:MAC:FCONtrol:PMANagement #H0,1 ... #H1,1
[SOURce<[1]|2>:]BB:WLAN:PSDU:MAC:FCONtrol:PVERsion #H0,1 ... #H1,1
[SOURce<[1]|2>:]BB:WLAN:PSDU:MAC:FCONtrol:RETRY #H0,1 ... #H1,1
[SOURce<[1]|2>:]BB:WLAN:PSDU:MAC:FCONtrol:SUBType #H0,4 ... #HF,4#H1,1
[SOURce<[1]|2>:]BB:WLAN:PSDU:MAC:FCONtrol:TDS #H0,1 ... #H1,1
[SOURce<[1]|2>:]BB:WLAN:PSDU:MAC:FCONtrol:TYPE #H0,2 ... #H3,2
[SOURce<[1]|2>:]BB:WLAN:PSDU:MAC:FCONtrol:WEP #H0,1 ... #H1,1
[SOURce:]BB:WLAN:PSDU:MAC:FCONtrol:FDS #H0,1 ... #H1,1
[SOURce:]BB:WLAN:PSDU:MAC:FCONtrol:FDS #H0,1 ... #H1,1

```

The command enters the value of the individual bits of the frame control field.

The MAC header can only be configured in framed mode (SOURce:BB:WLAN:SMODE FRAMed).

**Example:** "BB:WLAN:PSDU:MAC:FCON:MDAT #H1,1"  
'sets the value of the More Data bit.

*RST value	Resolution	Options	SCPI
#H0,1		B10/B11 and B13 K48 SOURce2 only with second option B9/B10/B11	Device-specific

```

[SOURce<[1]|2>:]BB:WLAN:PSDU:MAC:FCSequence:STATe #H0000,16 ... #HFFFF,16

```

Activates/deactivates the calculation of the FCS (frame check sequence). The standard defines a 32-bit (4-byte) check sum to protect the MAC header and the user data (frame body).

The command is only available in framed mode (SOURce:BB:WLAN:SMODE FRAMed).

**Example:** "BB:WLAN:PSDU:MAC:FCS:STAT ON"  
'activates the calculation of the FCS.

*RST value	Resolution	Options	SCPI
OFF		B10/B11 and B13 K48 SOURce2 only with second option B9/B10/B11	Device-specific

**[SOURce<[1]]2>:]BB:WLAN:PSDU:MAC:SCONtrol:FRAGment:INCRement 0 ... 1024**

Defines the number of packets required to increment the counter of the fragment bits of the sequence control.

The MAC header can only be configured in framed mode (SOURce:BB:WLAN:SMODE FRAMed).

**Example:** "BB:WLAN:PSDU:MAC:SCON:FRAG:INCR 2"  
 'two packets are required to increment the counter of the fragment bits.

*RST value	Resolution	Options	SCPI
1		B10/B11 and B13 K48 SOURce2 only with second option B9/B10/B11	Device-specific

**[SOURce<[1]]2>:]BB:WLAN:PSDU:MAC:SCONtrol:FRAGment:STARt #H0,4 ... #HF,4**

The command enters the start number of the fragment bits of the sequence control.

The MAC header can only be configured in framed mode (SOURce:BB:WLAN:SMODE FRAMed).

**Example:** "BB:WLAN:PSDU:MAC:SCON:FRAG:STAR #H4,4"  
 'sets the start value of the fragment bits of the sequence control.

*RST value	Resolution	Options	SCPI
#H0,04		B10/B11 and B13 K48 SOURce2 only with second option B9/B10/B11	Device-specific



**[SOURce<[1]>:]BB:WLAN:PSDU:MAC:SCONtrol:SEQuence:INCRement 0 ... 1024**

Defines the number of packets required to increment the counter of the sequence bits of the sequence control.

The MAC header can only be configured in framed mode (SOURce:BB:WLAN:SMODE FRAMed).

**Example:** "BB:WLAN:PSDU:MAC:SCON:FRAG:INCR 2"  
 'two packets are required to increment the counter of the sequence bits.

*RST value	Resolution	Options	SCPI
1		B10/B11 and B13 K48 SOURce2 only with second option B9/B10/B11	Device-specific

**[SOURce<[1]>:]BB:WLAN:PSDU:MAC:SCONtrol:SEQuence:STARt #H0,12 ... #HFFF,12**

The command enters the start number of the fragment bits of the sequence control.

The MAC header can only be configured in framed mode (SOURce:BB:WLAN:SMODE FRAMed).

**Example:** "BB:WLAN:PSDU:MAC:SCON:SEQ:STAR #H4,4"  
 'sets the start value of the sequence bits of the sequence control.

*RST value	Resolution	Options	SCPI
#H0,12		B10/B11 and B13 K48 SOURce2 only with second option B9/B10/B11	Device-specific

**[SOURce<[1]>:]BB:WLAN:PSDU:MAC:SCONtrol:STATe ON | OFF**

The command activates/deactivates the sequence control.

The MAC header can only be configured in framed mode (SOURce:BB:WLAN:SMODE FRAMed).

**Example:** "BB:WLAN:PSDU:MAC:SCON:STAT ON"  
 'activates the sequence control field.

*RST value	Resolution	Options	SCPI
OFF		B10/B11 and B13 K48 SOURce2 only with second option B9/B10/B11	Device-specific

**[SOURce<[1]>:]BB:WLAN:PSDU:MAC:STATe ON | OFF**

The command activates/deactivates the generation of the MAC Header.

The MAC header can only be configured in framed mode (SOURce:BB:WLAN:SMODE FRAMed).

**Example:** "BB:WLAN:PSDU:MAC:SCON:STAT ON"  
'activates the generation of the MAC Header.

*RST value	Resolution	Options	SCPI
OFF		B10/B11 and B13 K48 SOURce2 only with second option B9/B10/B11	Device-specific

**[SOURce<[1]>:]BB:WLAN:PSDU:MODulation**

The command queries the modulation type. The modulation mode depends on the selected PSDU bit rate which depends on the selected physical layer mode (SOURce:BB:WLAN:MODE)

The command is a query command and therefore has no \*RST value.

**Example:** "BB:WLAN:PSDU:MOD?"  
'queries the modulation mode.

Response: "DQPSK"

*RST value	Resolution	Options	SCPI
-		B10/B11 and B13 K48 SOURce2 only with second option B9/B10/B11	Device-specific

**[SOURce<[1]>:]BB:WLAN:PSDU:SCOut 1 ... 1378**

The command sets the number of data symbols. If the number of OFDM data symbols is changed, the generator calculates the data field length as a function of the set PSDU bit rate.

The command is only available in physical layer mode OFDM (SOURce:BB:WLAN:MODE OFDM).

**Example:** "BB:WLAN:PSDU:SCO 256"  
'sets the number of data symbols to 256.

*RST value	Resolution	Options	Dependencies	SCPI
4		B10/B11 and B13 K48 SOURce2 only with second option B9/B10/B11	If the number of OFDM data symbols is changed, the generator calculates the data field length (SOUR:BB:WLAN:PSDU:DLEN) as a function of the set PSDU bit rate.	Device-specific

[SOURce<[1]2>:]BB:WLAN:WAVeform:CREate <file\_name>

This command creates a waveform using the current settings of the **WLAN** menu. The file name is entered with the command. The file is stored with the predefined file extension \*.**wv**. The file name and the directory it is stored in are user-definable.

This command triggers an event and therefore has no \*RST value and no query form.

**Example:** "MMEM:CDIR 'D:\user\waveform'  
sets the default directory to D:\user\waveform.

"BB:WLAN:WAV:CRE 'wlan\_1'"  
'creates the waveform file wlan.wv in the default directory.

*RST value	Resolution	Options	SCPI
-	-	B10/B11 and B13 K50 SOURce2 only with second option B9/B10/B11	device-specific

# SOURce:BB:W3GPP Subsystem

The commands in the SOURce:BB:W3GPP subsystem are described in three sections, separated into general remote commands, commands for base station settings and commands for user equipment settings.

This subsystem contains commands for the primary and general settings of the 3GPP FDD standard. These settings concern activation and deactivation of the standard, setting the transmission direction, filter, clock, trigger and clipping settings, defining the chip rate and the sequence length, as well as the preset and power adjust setting.

The commands for setting the base station and the user equipment, the enhanced channels of the base and user equipment, as well as the commands for selecting the test models and the test setups, are described in separate sections. The commands are divided up in this way to make the extremely comprehensive SOURce:BB:W3GPP subsystem clearer.

The numerical suffix at SOURce distinguishes between path A and path B for two-path instruments:

SOURce<1> = path A

SOURce2 = path B

The keyword SOURce is optional with commands for path A and can be omitted. For path B, the command must include the keyword with the suffix 2.

Command	Parameters	Default unit	Comments
[SOURce<[1] 2>:]BB:W3GPP:CLIPping:LEVel	1...100	PCT	
[SOURce<[1] 2>:]BB:W3GPP:CLIPping:MODE	VECTor   SCALar		
[SOURce<[1] 2>:]BB:W3GPP:CLIPping:STATe	ON   OFF		
[SOURce<[1] 2>:]BB:W3GPP:CLOCK:MODE	CHIP   MCHip		
[SOURce<[1] 2>:]BB:W3GPP:CLOCK:MULTIplier	1... 64		
[SOURce<[1] 2>:]BB:W3GPP:CLOCK:SOURce	EXTernal   INTernal		
[SOURce<[1] 2>:]BB:W3GPP:COPY:COFFset	0...511		for DOWN LINK only
[SOURce<[1] 2>:]BB:W3GPP:COPY:DESTination	1...4		
[SOURce<[1] 2>:]BB:W3GPP:COPY:EXECute	-		
[SOURce<[1] 2>:]BB:W3GPP:COPY:SOURce	1...4		
[SOURce<[1] 2>:]BB:W3GPP:CRATE?	Answer: R3M84		Query only
[SOURce<[1] 2>:]BB:W3GPP:CRATE:VARiation	1 MHz ... 5 MHz	Hz (c/s)	
[SOURce<[1] 2>:]BB:W3GPP:FILTer:PARAmeter:APCO25	0.15 ... 2.5		
[SOURce<[1] 2>:]BB:W3GPP:FILTer:PARAmeter:COSSine	0.05 ... 0.99		
[SOURce<[1] 2>:]BB:W3GPP:FILTer:PARAmeter:GAUSSs	0.15 ... 2.5		
[SOURce<[1] 2>:]BB:W3GPP:FILTer:PARAmeter:RCOSSine	0.05 ... 0.99		
[SOURce<[1] 2>:]BB:W3GPP:FILTer:PARAmeter:SPHase	0.15 ... 2.5		
[SOURce<[1] 2>:]BB:W3GPP:FILTer:TYPE	RCOSSine   COSSine   GAUSSs   LGAUSSs   CONE   COF705   COEQUALizer   COFEQUALizer   C2K3x   APCO25   SPHase   PGAUSSs   RECTangle		
[SOURce:]BB:W3GPP:GPP3:VERSion?			Query only
[SOURce<[1] 2>:]BB:W3GPP:LINK	FORWard   REVERSE (Alias DOWN   UP)		

Command	Parameters	Default unit	Comments
[SOURCE<[1]>:]BB:W3GPP:POWER:ADJust	-		No query
[SOURCE<[1]>:]BB:W3GPP:POWER:TOTAl?			Query only
[SOURCE<[1]>:]BB:W3GPP:PRESet			No query
[SOURCE<[1]>:]BB:W3GPP:SEQuence	AUTO   RETRigger   AAUTo   ARETRigger   SINGLE		
[SOURCE<[1]>:]BB:W3GPP:SETTing:CATalog?			Query only
[SOURCE<[1]>:]BB:W3GPP:SETTing:DELeTe	<file_name>		
[SOURCE<[1]>:]BB:W3GPP:SETTing:LOAD	<file_name>		
[SOURCE<[1]>:]BB:W3GPP:SETTing:STORe	<file_name>		
[SOURCE<[1]>:]BB:W3GPP:SLENgth	1 ... 100 frames		
[SOURCE<[1]>:]BB:W3GPP:STATe	ON   OFF		
[SOURCE<[1]>:]BB:W3GPP:TRIGger:ARM:EXECute			No query
[SOURCE<[1]>:]BB:W3GPP:TRIGger:EXECute			No query
[SOURCE<[1]>:]BB:W3GPP:TRIGger[:EXTernal<[1]>]:DELay	0 ... (2 <sup>32</sup> - 1) Chips		
[SOURCE<[1]>:]BB:W3GPP:TRIGger[:EXTernal<[1]>]:INHibit	0 ... (2 <sup>32</sup> - 1) Chips		
[SOURCE<[1]>:]BB:W3GPP:TRIGger:OBASeband:DELay	0 ... (2 <sup>32</sup> - 1) Chips		
[SOURCE<[1]>:]BB:W3GPP:TRIGger:OBASeband:INHibit	0 ... (2 <sup>32</sup> - 1) Chips		
[SOURCE<[1]>:]BB:W3GPP:TRIGger:OUTPut<[1]...4>:MODE	SLOT   RFRame   CSPeriod   SFNR   USER   RATIo		
[SOURCE<[1]>:]BB:W3GPP:TRIGger:OUTPut<[1]...4>:DELay	0 ... (2 <sup>32</sup> - 1) Chips		
[SOURCE<[1]>:]BB:W3GPP:TRIGger:OUTPut:DELay:FIXed	ON   OFF	Hz	
[SOURCE<[1]>:]BB:W3GPP:TRIGger:OUTPut<[1]...4>:DELay:MAX?			Query only
[SOURCE<[1]>:]BB:W3GPP:TRIGger:OUTPut<[1]...4>:DELay:MIN?			Query only
[SOURCE<[1]>:]BB:W3GPP:TRIGger:OUTPut<[1]...4>:OFFTime	2 ... (2 <sup>24</sup> - 1) Chips		
[SOURCE<[1]>:]BB:W3GPP:TRIGger:OUTPut<[1]...4>:ONTime	2 ... (2 <sup>24</sup> - 1) Chips		
[SOURCE<[1]>:]BB:W3GPP:TRIGger:OUTPut<[1]...4>:PERiod	0 ... (2 <sup>32</sup> - 1) Chips		
[SOURCE<[1]>:]BB:W3GPP:TRIGger:RMODE			Query only
[SOURCE<[1]>:]BB:W3GPP:TRIGger:SLENgth	0 ... (2 <sup>32</sup> - 1) Chips		
[SOURCE<[1]>:]BB:W3GPP:TRIGger:SLUNit	FRAMe   SLOT   CHIP   SEQuence		
[SOURCE<[1]>:]BB:W3GPP:TRIGger:SOURce	EXTernal   BEXTernal   INTernal   OBASeband		
[SOURCE<[1]>:]BB:W3GPP:WAVEform:CREate			No query

[SOURce<[1]>:]BB:W3GPp:CLIPping:LEVel 0 ... 100 PCT

The command sets the limit for level clipping (Clipping). This value indicates at what point the signal is clipped. It is specified as a percentage, relative to the highest level. 100% indicates that clipping does not take place.

Level clipping is activated with the command SOUR:BB:W3GP:CLIP:STAT ON

**Example:** "BB:W3GP:CLIP:LEV 80PCT"  
 'sets the limit for level clipping to 80% of the maximum level.  
 "BB:W3GP:CLIP:STAT ON"  
 'activates level clipping.

*RST value	Resolution	Options	SCPI
100 PCT	1	B10/B11 and B13 K42 SOURce2 only with second option B9/B10/B11	Device-specific

[SOURce<[1]>:]BB:W3GPp:CLIPping:MODE VECTor | SCALar

The command sets the method for level clipping (Clipping).

**Parameters:** **VECTor**  
 The reference level is the amplitude  $|i+jq|$ .

**SCALar**  
 The reference level is the absolute maximum of the I and Q values.

**Example:** "BB:W3GP:CLIP:MODE SCAL"  
 'selects the absolute maximum of all the I and Q values as the reference level.  
 "BB:W3GP:CLIP:LEV 80PCT"  
 'sets the limit for level clipping to 80% of this maximum level.  
 "BB:W3GP:CLIP:STAT ON"  
 'activates level clipping.

*RST value	Resolution	Options	SCPI
VECTor	-	B10/B11 and B13 K42 SOURce2 only with second option B9/B10/B11	Device-specific

[SOURce<[1]|2>:]BB:W3GPp:CLIPping:STATe ON | OFF

The command activates level clipping (Clipping). The value is defined with the command [SOURce<[1]|2>:]BB:W3GPp:CLIPping:LEVel, the mode of calculation with the command [SOURce<[1]|2>:]BB:W3GPp:CLIPping:MODE.

**Example:** "BB:W3GP:CLIP:STAT ON"  
'activates level clipping.'

*RST value	Resolution	Options	SCPI
OFF		B10/B11 and B13 K42 SOURce2 only with second option B9/B10/B11	Device-specific

[SOURce<[1]|2>:]BB:W3GPp:CLOCK:MODE CHIP | MCHip

The command enters the type of externally supplied clock (:BB:W3GPp:CLOCK:SOURce EXTERNAL).

When MCHip is used, a multiple of the chip clock is supplied via the CLOCK connector and the chip clock is derived internally from this. The multiplier is entered with the command :BB:W3GPp:CLOCK:MULTIPLIER.

With this command the only numerical suffix allowed for SOURce is 1, since the external clock source is permanently allocated to path A.

**Example:** "BB:W3GP:CLOC:MODE CHIP"  
'selects clock type **Chip**, i.e. the supplied clock is a chip clock.'

*RST value	Resolution	Options	SCPI
CHIP	-	B10/B11 and B13 K42 SOURce2 only with second option B9/B10/B11	Device-specific

[SOURce<[1]|2>:]BB:W3GPp:CLOCK:MULTiplier 1 ... 64

The command specifies the multiplier for clock type **Multiplied** (:BB:W3GPp:CLOCK:MODE MCHip) in the case of an external clock source.

With this command the only numerical suffix allowed for SOURce is 1, since the external clock source is permanently allocated to path A.

**Example:** "BB:W3GP:CLOC:SOUR EXT"  
 'selects the external clock source. The clock is supplied via the CLOCK connector.

"BB:W3GP:CLOC:MODE MCH"  
 'selects clock type **Multiplied**, i.e. the supplied clock has a rate which is a multiple of the chip rate.

"BB:W3GP:CLOC:MULT 12"  
 'the multiplier for the external clock rate is 12.

*RST value	Resolution	Options	SCPI
4	1	B10/B11 and B13 K42 SOURce2 only with second option B9/B10/B11	Device-specific

[SOURce<[1]|2>:]BB:W3GPp:CLOCK:SOURce INTernal | EXTernal

The command selects the clock source.

Selecting EXTernal is only possible for path A, since the external clock source is permanently allocated to path A.

**Parameter:** **INTernal**  
 The internal clock reference is used.

**EXTernal**  
 The external clock reference is supplied to the CLOCK connector.

**Example:** "BB:W3GP:CLOC:SOUR EXT"  
 'selects an external clock reference for path A. The clock is supplied via the CLOCK connector.

"BB:W3GP:CLOC:MODE CHIP"  
 'specifies that a chip clock is supplied via the CLOCK connector.

*RST value	Resolution	Options	SCPI
INTernal	-	B10/B11 and B13 K42 SOURce2 only with second option B9/B10/B11	Device-specific



**[SOURce<[1]]2>:]BB:W3GPp:COPY:COFFset 0 ... 511**

The command sets the offset for the channelization code in the destination base station.

This command is only available in the downlink (SOUR:BB:W3GP:LINK FORW/DOWN).

**Example:** "BB:W3GP:COPY:COFF 10"  
 'the channelization code is shifted by 10 when the source base station is copied to the destination base station.

*RST value	Resolution	Options	SCPI
0	1	B10/B11 and B13 K42 SOURce2 only with second option B9/B10/B11	Device-specific

**[SOURce<[1]]2>:]BB:W3GPp:COPY:DESTination 1 ...4**

The command selects the station to which data is to be copied. Whether the data is copied to a base station or a user equipment depends on which transmission direction is selected (command W3GPp:LINK UP | DOWN).

**Example:** "BB:W3GP:LINK DOWN"  
 'selects the downlink transmit direction (base station to user equipment)  
 "BB:W3GP:COPY:SOUR 1"  
 'selects base station 1 as the source.  
 "BB:W3GP:COPY:DEST 4"  
 'selects base station 4 as the destination.  
 "BB:W3GP:COPY:EXEC"  
 'starts copying the parameter set of base station 1 to base station 4.

*RST value	Resolution	Options	SCPI
2	-	B10/B11 and B13 K42 SOURce2 only with second option B9/B10/B11	Device-specific

**[SOURce<[1]]2>:]BB:W3GPp:COPY:EXECute**

The command starts the copy process. The dataset of the source station is copied to the destination station. Whether the data is copied to a base station or a user equipment depends on which transmission direction is selected (command W3GPp:LINK UP | DOWN).

This command triggers an event and therefore has no \*RST value and no query form.

**Example:** "BB:W3GP:COPY:EXEC"  
 'starts copying the parameter set of the selected source station to the selected destination station.

*RST value	Resolution	Options	SCPI
-	-	B10/B11 and B13 K42 SOURce2 only with second option B9/B10/B11	Device-specific

**[SOURce<[1]|2>:]BB:W3GPp:COPY:SOURce 1 ...4**

The command selects the station that has data to be copied. Whether the station copied is a base or user equipment depends on which transmission direction is selected (command W3GPp:LINK UP | DOWN).

**Example:** "BB:W3GP:LINK UP"  
 'selects the uplink transmit direction (user equipment to base station).  
 "BB:W3GP:COPY:SOUR 1"  
 'selects user equipment 1 as the source.  
 "BB:W3GP:COPY:DEST 4"  
 'selects user equipment 4 as the destination.  
 "BB:W3GP:COPY:EXEC"  
 'starts copying the parameter set of user equipment 1 to user equipment 4.

*RST value	Resolution	Options	SCPI
1	-	B10/B11 and B13 K42 SOURce2 only with second option B9/B10/B11	Device-specific

**[SOURce<[1]|2>:]BB:W3GPp:CRATe?**

The command queries the set system chip rate. The output chip rate can be set with the command SOUR:BB:W3GP:CRAT:VAR

The command is a query command and therefore does not have an \*RST value.

**Example** "BB:W3GP:CRAT?"  
 'queries the system chip rate.  
 Response: "R3M8"  
 'the system chip rate is 3.8 Mcps.

*RST value	Resolution	Options	SCPI
-	-	B10/B11 and B13 K42 SOURce2 only with second option B9/B10/B11	Device-specific

**[SOURce<[1]>:]BB:W3GPp:CRATe:VARIation 1 Mcps ... 5 Mcps**

The command enters the output chip rate.

The chip rate entry changes the output clock and the modulation bandwidth, as well as the synchronization signals that are output. It does not affect the calculated chip sequence.

**Example:** "BB:W3GP:CRAT:VAR 4086001"  
"sets the chip rate to 4.08 Mcps.

*RST value	Resolution	Options	SCPI
3.84 MHz	1 Hz	B10/B11 and B13 K42 SOURce2 only with second option B9/B10/B11	Device-specific

**[SOURce<[1]>:]BB:W3GPp:FILTer:PARAmeter:APCO25 0.05 ... 0.99**

The command sets the roll-off factor for filter type APCO25.

**Example:** "BB:W3GP:FILT:PAR:APCO25 0.2"  
'sets the roll-off factor to 0.2 for filter type APCO25.

*RST value	Resolution	Options	SCPI
0.20	0.01	B10/B11 and B13 K42 SOURce2 only with second option B9/B10/B11	Device-specific

**[SOURce<[1]>:]BB:W3GPp:FILTer:PARAmeter:COSSine 0.05 ... 0.99**

The command sets the roll-off factor for the Cosine filter type.

**Example:** "BB:W3GP:FILT:PAR:COS 0.35"  
'sets the roll-off factor to 0.35 for filter type Cosine.

*RST value	Resolution	Options	SCPI
0.35	0.01	B10/B11 and B13 K42 SOURce2 only with second option B9/B10/B11	Device-specific

[SOURce<[1]|2>:]BB:W3GPp:FILTer:PARAmeter:GAUSs 0.15 ... 2.5

The command sets the roll-off factor for the Gauss filter type.

**Example:** "BB:W3GP:FILT:PAR:GAUS 0.5"  
 'sets B x T to 0.5 for the Gauss filter type.

*RST value	Resolution	Options	SCPI
0.5	0.01	B10/B11 and B13 K42 SOURce2 only with second option B9/B10/B11	Device-specific

[SOURce<[1]|2>:]BB:W3GPp:FILTer:PARAmeter:RCOSine 0.05 ... 0.99

The command sets the roll-off factor for the Root Cosine filter type.

**Example:** "BB:W3GP:FILT:PAR:RCOS 0.22"  
 'sets the roll-off factor to 0.22 for filter type Root Cosine.

*RST value	Resolution	Options	SCPI
0.22	0.01	B10/B11 and B13 K42 SOURce2 only with second option B9/B10/B11	Device-specific

[SOURce<[1]|2>:]BB:W3GPp:FILTer:PARAmeter:SPHase 0.15 ... 2.5

The command sets B x T for the Split Phase filter type.

**Example:** "BB:W3GP:FILT:PAR:SPH 0.5"  
 'sets B x T to 0.5 for the Split Phase filter type.

*RST value	Resolution	Options	SCPI
2.00	0.01	B10/B11 and B13 K42 SOURce2 only with second option B9/B10/B11	Device-specific

[SOURce<[1]|2>:]BB:W3GPP:FILTer:TYPE RCOSine | COSine | GAUSs | LGAuss | CONE | COF705 | COEqualizer | COFequalizer | C2K3x | APCO25 | SPHase | RECTangle | PGAuss

The command selects the filter type. The filter types are described in Chapter 4, Section "[Custom Dig Mod](#)".

**Example:** "BB:W3GP:FILT:TYPE COS"  
'sets the filter type COSine.

*RST value	Resolution	Options	SCPI
RCOSine	-	B10/B11 and B13 K42 SOURce2 only with second option B9/B10/B11	Device-specific

[SOURce:]BB:W3GPP:GPP3:VERSion?

The command queries the version of the 3GPP standard underlying the definitions.

The command is a query command and therefore does not have an \*RST value. The numerical suffix at SOURce has no significance for this command and should not be specified.

**Example:** "BB:W3GP:GPP3:VERS?"  
'queries the 3GPP version.

Response: "v6.0.0"  
'3GPP version 6

*RST value	Resolution	Options	SCPI
-	-	B10/B11 and B13 K42 SOURce2 only with second option B9/B10/B11	Device-specific

[SOURce<[1]|2>:]BB:W3GPP:LINK FORWard|DOWN | REVerse|UP

The command defines the transmission direction. The signal either corresponds to that of a base station (FORWard | DOWN) or that of a user equipment (REVerse | UP).

**Example:** "BB:W3GP:LINK DOWN"  
'the transmission direction selected is base station to user equipment. The signal corresponds to that of a base station.

*RST value	Resolution	Options	SCPI
FORWard DOWN	-	B10/B11 and B13 K42 SOURce2 only with second option B9/B10/B11	Device-specific

**[SOURce<[1]>:]BB:W3GPP:POWER[:TOTal]?**

The command queries the total power of the active channels. After **Power Adjust**, this power corresponds to 0 dB.

The command is a query command and therefore does not have an \*RST value.

**Example:** "BB:W3GP:POW?"  
'queries the total power of the active channels.

Response: "-22.5"  
'the total power is -25 dB.

*RST value	Resolution	Options	SCPI
-	-	B10/B11 and B13 K42 SOURce2 only with second option B9/B10/B11	Device-specific

**[SOURce<[1]>:]BB:W3GPP:POWER:ADJust**

The command sets the power of the active channels in such a way that the total power of the active channels is 0 dB. This will not change the power ratio among the individual channels.

The command triggers an action and therefore has no \*RST value and no query form.

**Example:** "BB:W3GP:POW:ADJ"  
'the total power of the active channels is set to 0 dB, the power ratio among the individual channels is unchanged.

*RST value	Resolution	Options	SCPI
-	-	B10/B11 and B13 K42 SOURce2 only with second option B9/B10/B11	Device-specific

**[SOURce<[1]>:]BB:W3GPP:PRESet**

The command produces a standardized default for the 3GPP FDD standard. The settings correspond to the \*RST values specified for the commands.

This command triggers an action and therefore has no \*RST value and no query form.

**Example:** "BB:W3GP:PRES"  
'resets all the 3GPP FDD settings to default values.

*RST value	Resolution	Options	Dependencies	SCPI
-	-	B10/B11 and B13 K42 SOURce2 only with second option B9/B10/B11	All 3GPP FDD settings are preset.	Device-specific

[SOURce<[1]|2>:]BB:W3GPp:SEQUence AUTO | RETRigger | AAUTo | ARETrigger | SINGle

The command selects the trigger mode.

**Parameter:**      **AUTO**

The modulation signal is generated continuously.

**RETRigger**

The modulation signal is generated continuously. A trigger event (internal or external) causes a restart.

**AAUTo**

The modulation signal is generated only when a trigger event occurs. After the trigger event the signal is generated continuously. Signal generation is stopped with command SOUR:BB:W3GP:TRIG:ARM:EXEC and started again when a trigger event occurs.

**ARETrigger**

The modulation signal is generated only when a trigger event occurs. The device automatically toggles to RETRIG mode. Every subsequent trigger event causes a restart.

Signal generation is stopped with command

SOUR:BB:W3GP:TRIG:ARM:EXEC and started again when a trigger event occurs.

**SINGle**

The modulation signal is generated only when a trigger event occurs. Then the signal is generated once to the length specified with command SOUR:BB:W3GP:TRIG:SLen. Every subsequent trigger event causes a restart.

**Example:**

"BB:W3GP:SEQ AAUT"

'sets the **Armed\_auto** trigger mode; the device waits for the first trigger (e.g. with \*TRG) and then generates the signal continuously.

*RST value	Resolution	Options	SCPI
AUTO	-	B10/B11 and B13 K42 SOURce2 only with second option B9/B10/B11	Device-specific

**[SOURce<[1]>:]BB:W3GPP:SETting:CATalog?**

This command reads out the files with 3GPP FDD settings in the default directory. The default directory is set using command `MMEM:CDIRectory`. A path can also be specified, in which case the files in the specified directory are read. Only files with the file extension `*.3g` will be listed.

The command is a query command and therefore has no `*RST` value.

**Example:** `"MMEM:CDIR 'D:\user\dig_mod"`  
 'sets the default directory to D:\user\dig\_mod.  
`"BB:W3GP:SETT:CAT?"`  
 'reads out all the files with 3GPP FDD settings in the default directory.  
 Response: `"'UPLINK', 'DOWNLINK'"`  
 'the files `'UPLINK'` and `'DOWNLINK'` are available.

*RST value	Resolution	Options	SCPI
	-	B10/B11 and B13 K42 SOURce2 only with second option B9/B10/B11	Device-specific

**[SOURce<[1]>:]BB:W3GPP:SETting:DELeTe <file\_name>**

This command deletes the selected file with 3GPP FDD settings The directory is set using command `MMEM:CDIRectory`. A path can also be specified, in which case the files in the specified directory are read. The file extension may be omitted. Only files with the file extension `*.3g` will be deleted.

This command triggers an event and therefore has no `*RST` value and no query form.

**Example:** `"BB:W3GP:SETT:DEL 'UPLINK'"`  
 'deletes file `'UPLINK'`.

*RST value	Resolution	Options	SCPI
	-	B10/B11 and B13 K42 SOURce2 only with second option B9/B10/B11	Device-specific

**[SOURce<[1]>:]BB:W3GPP:SETting:LOAD <file\_name>**

This command loads the selected file with 3GPP FDD settings The directory is set using command `MMEM:CDIRectory`. A path can also be specified, in which case the files in the specified directory are read. The file extension may be omitted. Only files with the file extension `*.3g` will be loaded.

This command triggers an event and therefore has no `*RST` value and no query form.

**Example:** `"BB:W3GP:SETT:LOAD 'UPLINK'"`  
 'loads file `'UPLINK'`.

*RST value	Resolution	Options	SCPI
	-	B10/B11 and B13 K42 SOURce2 only with second option B9/B10/B11	Device-specific



[SOURce<[1]|2>:]BB:W3GPP:SETTing:STORe <file\_name>

This command stores the current 3GPP FDD settings into the selected file. The directory is set using command `MMEM:CDIRectory`. A path can also be specified, in which case the files in the specified directory are read. Only the file name has to be entered. 3GPP FDD settings are stored as files with the specific file extensions `*.3g`.

This command triggers an event and therefore has no `*RST` value and no query form.

**Example:** `"BB:W3GP:SETT:STOR 'UPLINK'"`  
 'stores the current 3GPP FDD settings into file 'UPLINK'.'

*RST value	Resolution	Options	SCPI
	-	B10/B11 and B13 K42 SOURce2 only with second option B9/B10/B11	Device-specific

[SOURce<[1]|2>:]BB:W3GPP:SLENgth 1 ... 100 frames

The command sets the sequence length of the arbitrary waveform component of the 3GPP signal in the number of frames. This component is calculated in advance and output in the arbitrary waveform generator. It is added to the realtime signal components (Enhanced Channels).

**Example:** `"BB:W3GP:SLEN 10"`  
 'sets the sequence length to 10 frames.'

*RST value	Resolution	Options	SCPI
1	-	B10/B11 and B13 K42 SOURce2 only with second option B9/B10/B11	Device-specific

[SOURce<[1]|2>:]BB:W3GPP:STATe ON | OFF

The command activates modulation in accordance with the 3GPP FDD standard. Activating this standard deactivates all the other digital standards and digital modulation modes on the same path.

**Example:** `"BB:W3GP:STAT ON"`  
 'activates modulation in accordance with the 3GPP FDD standard.'

*RST value	Resolution	Options	Dependencies	SCPI
OFF	-	B10/B11 and B13 K42 SOURce2 only with second option B9/B10/B11	BB:W3GP:STAT ON deactivates the other standards and digital modulation.	Device-specific

[SOURce<[1]|2>:]BB:W3GPp:TRIGger:ARM:EXECute

The command stops signal generation for trigger modes Armed\_Auto and Armed\_Retrigger. A subsequent internal or external trigger event restart signal generation.

This command triggers an event and therefore has no \*RST value and no query form.

**Example:** "BB:W3GP:TRIG:SOUR INT"  
 'sets internal triggering.

"BB:W3GP:TRIG:SEQ ARET"  
 'sets Armed\_Retrigger mode, i.e. every trigger event causes signal generation to restart.

"BB:W3GP:TRIG:EXEC"  
 'executes a trigger, signal generation is started.

"BB:W3GP:TRIG:ARM:EXEC"  
 'signal generation is stopped.

"BB:W3GP:TRIG:EXEC"  
 'executes a trigger, signal generation is started again.

*RST value	Resolution	Options	SCPI
		B10/B11 and B13 K42 SOURce2 only with second option B9/B10/B11	Device-specific

[SOURce<[1]|2>:]BB:W3GPp:TRIGger:EXECute

The command executes a trigger. The internal trigger source must be selected using the command BB:W3GP:TRIG:SOUR INT and a trigger mode other than AUTO must be selected using the command :BB:W3GP:TRIG:SEQ.

This command triggers an event and therefore has no \*RST value and no query form.

**Example:** "BB:W3GP:TRIG:SOUR INT"  
 'sets internal triggering.

"BB:W3GP:TRIG:SEQ RETR"  
 'sets Retrigger mode, i.e. every trigger event causes signal generation to restart.

"BB:W3GP:TRIG:EXEC"  
 'executes a trigger.

*RST value	Resolution	Options	SCPI
		B10/B11 and B13 K42 SOURce2 only with second option B9/B10/B11	Device-specific

**[SOURce<[1]>:]BB:W3GPp:TRIGger[:EXtErnal<[1]>]:DELay 0 ... 2<sup>32</sup>-1**

The command specifies the trigger delay (expressed as a number of chips) for external triggering. The numeric suffix to EXtErnal distinguishes between the external trigger via the TRIGGER 1 (suffix 1) and TRIGGER 2 (suffix 2) connector.

**Example:**       "BB:W3GP:TRIG:SOUR EXT"  
                  'sets an external trigger via the TRIGGER 1 connector.

                  "BB:W3GP:TRIG:DEL 50"  
                  'sets a delay of 50 chips for the trigger.

*RST value	Resolution	Options	SCPI
0 chips	1 chip	B10/B11 and B13 K42 SOURce2 only with second option B9/B10/B11	Device-specific

**[SOURce<[1]>:]BB:W3GPp:TRIGger[:EXtErnal<[1]>]:INHibit 0 ... 2<sup>32</sup>-1**

The command specifies the number of chips by which a restart is to be inhibited following a trigger event. This command applies only in the case of external triggering. The numeric suffix to EXtErnal distinguishes between the external trigger via the TRIGGER 1 (suffix 1) and TRIGGER 2 (suffix 2) connector.

**Example:**       "BB:W3GP:TRIG:SOUR EXT"  
                  'selects an external trigger via the TRIGGER 1 connector.

                  "BB:W3GP:TRIG:INH 200"  
                  'sets a restart inhibit for 200 chips following a trigger event.

*RST value	Resolution	Options	SCPI
0 chips	1 chip	B10/B11 and B13 K42 SOURce2 only with second option B9/B10/B11	Device-specific

**[SOURce<[1]>:]BB:W3GPp:TRIGger:OBASeband:DELay 0 ... 2<sup>32</sup>-1**

The command specifies the trigger delay (expressed as a number of chips) for triggering by the trigger signal from the second path (two-path instruments only).

**Example:**       "BB:W3GP:TRIG:SOUR OBAS"  
                  'sets for path A the internal trigger executed by the trigger signal from the second path (path B).

                  "BB:W3GP:TRIG:OBAS:DEL 50"  
                  'sets a delay of 50 chips for the trigger.

*RST value	Resolution	Options	SCPI
0 chips	1 chip	B10/B11 and B13 K42Only with second option B13	Device-specific

[SOURce<[1]|2>:]BB:W3GPp:TRIGger:OBASband:INHibit 0 ... 2^32-1

The command specifies the number of chips by which a restart is to be inhibited following a trigger event. This command applies only for triggering by the second path (two-path instruments only).

**Example:** "BB:W3GP:TRIG:SOUR OBAS"  
 'sets for path A the internal trigger executed by the trigger signal from the second path (path B).

"BB:W3GP:TRIG:INH 200"  
 'sets a restart inhibit for 200 chips following a trigger event.

*RST value	Resolution	Options	SCPI
0 chips	1 chip	B10/B11 and B13 K42Only with second option B13	Device-specific

[SOURce<[1]|2>:]BB:W3GPp:TRIGger:OUTPut<[1]...4>:MODE SLOT | RFRame | SFRame | CSPeriod | SFNR | RATio | USER

The command defines the signal for the selected marker output.

- Parameter: SLOT**  
 A marker signal is generated at the start of each slot (every 2560 chips or 0.667 ms).
- RFRame**  
 A marker signal is generated at the start of each frame (every 38400 chips or 10 ms).
- CSPeriod**  
 A marker signal is generated at the start of every arbitrary waveform sequence (depending on the setting for the arbitrary waveform sequence length). If the signal does not contain an arbitrary waveform component, a radio frame trigger is generated.
- SFNR**  
 A marker signal is generated at the start of every SFN period (every 4096 frames).
- RATio**  
 A marker signal corresponding to the Time Off / Time On specifications in the commands SOURce:BB:W3GPp:TRIGger:OUTPut:OFFT and SOURce:BB:W3GPp:TRIGger:OUTPut:ONT is generated.
- USER**  
 A marker signal is generated at the beginning of every user-defined period. The period is defined with command SOUR:BB:W3GP:TRIG:OUTP:PERiod

**Example:** "BB:W3GP:TRIG:OUTP2:MODE SLOT"  
 'selects the slot marker signal on output MARKER 2.

*RST value	Resolution	Options	SCPI
RFRame	-	B10/B11 and B13 K42 SOURce2 only with second option B9/B10/B11	Device-specific

**[SOURce<[1]>:]BB:W3GPp:TRIGger:OUTPut<[1]...4>:DELay 0 ... 2^32 - 1 Chips**

The command defines the delay between the signal on the marker outputs and the start of the signal, expressed in terms of chips. Command :BB:W3GPp:TRIGger:OUTPut:DELay:FIXed can be used to restrict the range of values to the dynamic range, i.e. the range within which a delay of the marker signals can be set without restarting the marker and signal.

**Example:** "BB:W3GP:TRIG:OUTP2:DEL 16000"  
'sets a delay of 16000 chips for the signal on connector MARKER 2.

*RST value	Resolution	Options	SCPI
0	1 Chip	B10/B11 and B13 K42 SOURce2 only with second option B9/B10/B11	Device-specific

**[SOURce<[1]>:]BB:W3GPp:TRIGger:OUTPut:DELay:FIXed ON | OFF**

The command restricts the marker delay setting range to the dynamic range. In this range the delay can be set without restarting the marker and signal. If a delay is entered in setting ON but is outside this range, the maximum possible delay is set and an error message is generated.

The numeric suffix in OUTPut has no significance for this command, since the setting always affects every marker.

**Example:** "BB:W3GP:TRIG:OUTP:DEL:FIX ON"  
'restricts the marker signal delay setting range to the dynamic range.

*RST value	Resolution	Options	SCPI
OFF	-	B10/B11 and B13 K42 SOURce2 only with second option B9/B10/B11	Device-specific

**[SOURce<[1]>:]BB:W3GPp:TRIGger:OUTPut<[1]...4>:DELay:MAXimum**

The command queries the maximum marker delay for setting :BB:W3GPp:TRIG:OUTP:DEL:FIX ON.

The command is a query only and therefore has no \*RST value.

**Example:** "BB:W3GP:TRIG:OUTP:DEL:FIX ON"  
'restricts the marker signal delay setting range to the dynamic range.

"BB:W3GP:TRIG:OUTP:DEL:MAX"  
'queries the maximum of the dynamic range.

Response: "20000"  
'the maximum for the marker delay setting is 20000 chips.

*RST value	Resolution	Options	SCPI
-	-	B10/B11 and B13 K42 SOURce2 only with second option B9/B10/B11	Device-specific

**[SOURce<[1]|2>:]BB:W3GPp:TRIGger:OUTPut<[1]...4>:DELay:MINimum**

The command queries the minimum marker delay for setting :BB:W3GPp:TRIGger:OUTPut:DELay:FIXed ON.

The command is a query only and therefore has no \*RST value.

**Example:** "BB:W3GP:TRIG:OUTP:DEL:FIX ON"  
'restricts the marker signal delay setting range to the dynamic range.

"BB:W3GP:TRIG:OUTP:DEL:MIN"  
'queries the minimum of the dynamic range.

Response: "0"  
'the minimum for the marker delay setting is 0 chips.

*RST value	Resolution	Options	SCPI
-	-	B10/B11 and B13 K42 SOURce2 only with second option B9/B10/B11	Device-specific

**[SOURce<[1]|2>:]BB:W3GPp:TRIGger:OUTPut<[1]...4>:OFFTime 1.. 2<sup>24</sup> - 1 (1..16 777 215) chips**

The command sets the number of chips in a period (ON time + OFF time) during which the marker signal in setting SOURce:BB:W3GPp:TRIGger:OUTPut:MODE RATio on the marker outputs is OFF.

**Example:** "BB:W3GP:TRIG:OUTP2:OFFT 2000"  
'sets an OFF time of 2000 chips for marker signal 2 on path A.

*RST value	Resolution	Options	SCPI
1	1	B10/B11 and B13 K42 SOURce2 only with second option B9/B10/B11	Device-specific

**[SOURce<[1]|2>:]BB:W3GPp:TRIGger:OUTPut<[1]...4>:ONTime 1.. 2<sup>24</sup> - 1 (1..16 777 215) chips**

The command sets the number of chips in a period (ON time + OFF time) during which the marker signal in setting SOURce:BB:W3GPp:TRIGger:OUTPut:MODE RATio on the marker outputs is ON.

**Example:** "BB:W3GP:TRIG:OUTP2:ONT 2000"  
'sets an ON time of 2000 chips for marker 2 on path A.

*RST value	Resolution	Options	SCPI
1	1	B10/B11 and B13 K42 SOURce2 only with second option B9/B10/B11	Device-specific

**[SOURce<[1]|2>:]BB:W3GPP:TRIGger:OUTPut<[1]...4>:PERiod 1... 2^32-1 Chips**

The command sets the repetition rate for the signal at the marker outputs, expressed in terms of chips. The setting is only valid for selection USER in :W3GP:TRIG:OUTP:MODE.

**Example:** "BB:W3GP:TRIG:OUTP2:MODE USER"  
 'selects the user marker for the signal on connector MARKER 2.

"BB:W3GP:TRIG:OUTP2:PER 1600"  
 'sets a period of 1600 chips, i.e. the marker signal is repeated every 1600th chip.

*RST value	Resolution	Options	SCPI
1 Frame (38 400 Chips)	1 Chip	B10/B11 and B13 K42 SOURce2 only with second option B9/B10/B11	Device-specific

**[SOURce<[1]|2>:]BB:W3GPP:TRIGger:RMODE**

The command queries the current status of signal generation for all trigger modes with 3GPP FDD modulation on.

The command is a query command and therefore has no \*RST value.

**Parameter:** **RUN**  
 the signal is generated. A trigger event occurred in the triggered mode.

**STOP**  
 the signal is not generated. A trigger event did not occur in the triggered modes, or signal generation was stopped by the command  
 :BB:W3GP:TRIG:ARM:EXECute (armed trigger modes only).

**Example:** "SOUR2:BB:W3GP:TRIG:SOUR EXT"  
 'sets external triggering via the TRIGGER 1 connector for path B of a two-path instrument.

"SOUR2:BB:W3GP:TRIG:MODE ARET"  
 'selects the Armed\_Retrigger mode.

"SOUR2:BB:W3GP:TRIG:RMOD?"  
 'queries the current status of signal generation.

**Response:** "RUN"  
 'the signal is generated, an external trigger was executed.

*RST value	Resolution	Options	SCPI
-	-	B10/B11 and B13 K42 SOURce2 only with second option B9/B10/B11	Device-specific

[SOURce<[1]|2>:]BB:W3GpP:TRIGger:SLENgth 1 ... (2^32-1) chips

The command defines the length of the signal sequence to be output in the **Single** trigger mode (SOUR:BB:W3GpP:SEQ SING). The unit is defined with command SOUR:BB:W3GpP:TRIG:SLUNit.

It is possible to output deliberately just part of the frame, an exact sequence of the frame, or a defined number of repetitions of the frame.

**Example:**            "SOUR2:BB:W3GpP:SEQ SING"  
                               'sets trigger mode Single.

                              "SOUR2:BB:W3GpP:TRIG:SLUN CHIP"  
                               'sets unit chips for the entry of sequence length.

                              "SOUR2:BB:W3GpP:TRIG:SLEN 200"  
                               'sets a sequence length of 200 chips. The first 200 chips of the current frame will be output after the next trigger event.

*RST value	Resolution	Options	SCPI
1 frame length	-	B10/B11 and B13 K42 SOURce2 only with second option B9/B10/B11	Device-specific

[SOURce<[1]|2>:]BB:W3GpP:TRIGger:SLUNit FRAMe | SLOT | CHIP | SEQuence

The command defines the unit for the entry of the length of the signal sequence (SOUR:BB:W3GpP:TRIG:SLEN) to be output in the **Single** trigger mode (SOUR:BB:W3GpP:SEQ SING).

**Example:**            "SOUR2:BB:W3GpP:SEQ SING"  
                               'sets trigger mode Single.

                              "SOUR2:BB:W3GpP:TRIG:SLUN FRAM"  
                               'sets unit frames for the entry of sequence length.

                              "SOUR2:BB:W3GpP:TRIG:SLEN 2"  
                               'sets a sequence length of 2 frames. The current frame will be output twice after the next trigger event.

*RST value	Resolution	Options	SCPI
SEQuence	-	B10/B11 and B13 K42 SOURce2 only with second option B9/B10/B11	Device-specific



[SOURce<[1]|2>:]BB:W3GPp:TRIGger:SOURce INTernal | EXTernal | BEXTernal | OBASeband

The command selects the trigger source.

**Parameter:**       **INTernal**  
 Triggering is executed by means of the Trigger command  
 SOURce<[1]|2>:BB:W3GPp:TRIGger:EXECute or \*TRG in the case of  
 remote control and by means of **Execute Trigger** in the case of manual  
 operation.

**EXTernal**  
 Triggering is executed by means of the signal on the TRIGGER 1 connector.

**BEXTernal**  
 Triggering is executed by means of the signal on the TRIGGER 2 connector.

**OBASeband**  
 Triggering is executed by means of the trigger signal from the second path  
 (two-path instruments only).

**Example:**       " SOUR2 :BB :W3GP :TRIG :SOUR EXT"  
 'sets external triggering via the TRIGGER 1 connector for path B of a two-path  
 instrument.

*RST value	Resolution	Options	SCPI
INTernal	-	B10/B11 and B13 K42 SOURce2 only with second option B9/B10/B11	Device-specific

[SOURce<[1]|2>:]BB:W3GPp:WAVeform:CREate <file\_name>

This command creates a waveform using the current settings of the **3GPP FDD** menu. The file name is entered with the command. The file is stored with the predefined file extension \*.wv. The file name and the directory it is stored in are user-definable..

This command triggers an event and therefore has no \*RST value and no query form.

**Example:**       "MMEM:CDIR 'D:\user\waveform"  
 'sets the default directory to D:\user\waveform.  
 "BB:W3GP:WAV:CRE 'gpp3\_bs'"  
 'creates the waveform file gpp3\_bs.wv in the default directory.

*RST value	Resolution	Options	SCPI
-	-	B10/B11 and B13 K42 SOURce2 only with second option B9/B10/B11	device-specific

## SOURce:W3GPP - Test Models and Predefined Settings

The R&S Vector Signal Generator gives you the opportunity to generate standardized or predefined test settings:

### Test Models...

- Selection of test models for the downlink in accordance with 3GPP standard 25.141.
- Selection of non-standardized test models for the uplink.

### Predefined Settings...

- Definition of Predefined Settings for base station 1 which enable the creation of highly complex scenarios for the downlink by presetting the channel table of base station 1. The settings take effect only after execution of command [SOURce<[1]|2>:]BB:W3GPP:PPARameter:EXECute.

Command	Parameters	Default unit	Comments
[SOURce<[1] 2>:]BB:W3GPP:PPARameter:CRESt	MINimum   AVERage   WORSt		
[SOURce<[1] 2>:]BB:W3GPP:PPARameter:DPCH:COUNT	0...512		
[SOURce<[1] 2>:]BB:W3GPP:PPARameter:DPCH:SRATe	D7K5   D15K   D30K   D60K   D120K   D240K   D480K   D960K		
[SOURce<[1] 2>:]BB:W3GPP:PPARameter:EXECute			No query
[SOURce<[1] 2>:]BB:W3GPP:PPARameter:SCCPch:SRATe	D15K   D30K   D60K   D120K   D240K   D480K   D960K		
[SOURce<[1] 2>:]BB:W3GPP:PPARameter:SCCPch:STATe	ON   OFF		
[SOURce<[1] 2>:]BB:W3GPP:PPARameter:SCHannels	ON   OFF		
[SOURce<[1] 2>:]BB:W3GPP:SETTing:TMODeL:BSTation	<test_model_name>		
[SOURce<[1] 2>:]BB:W3GPP:SETTing:TMODeL:BSTation:CATalog	'name'		Query only
[SOURce<[1] 2>:]BB:W3GPP:SETTing:TMODeL:MSTation	<test_model_name>		
[SOURce<[1] 2>:]BB:W3GPP:SETTing:TMODeL:MSTation:CATalog?			Query only

**[SOURce<[1]|2>:]BB:W3GPp:PPARameter:CRESt MINimum | AVERAge | WORSt**

This commands selects the desired range for the crest factor of the test scenario. The crest factor of the signal is kept in the desired range by automatically setting appropriate channelization codes and timing offsets.

The setting takes effect only after execution of command

```
[SOURce<[1]|2>:]BB:W3GPp:PPARameter:EXECute.
```

**Parameter: MINimum**  
 The crest factor is minimized. The channelization codes are distributed uniformly over the code domain. The timing offsets are increased by 3 per channel.

**AVERAge**  
 An average crest factor is set. The channelization codes are distributed uniformly over the code domain. The timing offsets are all set to 0.

**WORSt**  
 The crest factor is set to an unfavorable value (i.e. maximum). The channelization codes are assigned in ascending order. The timing offsets are all set to 0.

**Example:** "BB:W3GP:PPAR:CRESt WORSt"  
 'sets the crest factor to an unfavorable value.'

*RST value	Options	Dependencies	SCPI
MINimum	B10/B11 and B13 K42 SOURce2 only with second option B9/B10/B11	The settings of commands BB:W3GP:BST<n>:CHAN<n>:CCODE and BB:W3GP:BST<n>:CHAN<n>:TOFFset are adjusted according to the selection	Device-specific

**[SOURce<[1]|2>:]BB:W3GPp:PPARameter:DPCH:COUNT 0 ... 512**

This command sets the number of activated DPCHs. The maximum number is the ratio of the chip rate and the symbol rate (maximum 512 at the lowest symbol rate of 7.5 kbps).

The setting takes effect only after execution of command

```
[SOURce<[1]|2>:]BB:W3GPp:PPARameter:EXECute.
```

**Example:** "BB:W3GP:PPAR:DPCH:COUNT 21"  
 'the predefined signal contains 21 DPCHs.'

*RST value	Resolution	Options	SCPI
10	-	B10/B11 and B13 K42 SOURce2 only with second option B9/B10/B11	Device-specific

**[SOURce<[1]|2>:]BB:W3GPP:PPARAmeter:DPCH:SRATe**  
 D7K5 | D15K | D30K | D60K | D120K | D240K | D480K | D960K

This command sets the symbol rate of DPCHs.

The setting takes effect only after execution of command  
 [SOURce<[1]|2>:]BB:W3GPP:PPARAmeter:EXECute.

**Example:** "BB:W3GP:PPAR:DPCH:SRAT D240K"  
 'sets the symbol rate of the DPCHs to 240ksps.

*RST value	Resolution	Options	SCPI
D30K	-	B10/B11 and B13 K42 SOURce2 only with second option B9/B10/B11	Device-specific

**[SOURce<[1]|2>:]BB:W3GPP:PPARAmeter:EXECute**

This command presets the channel table of base station 1 with the parameters defined by the PPARAmeter commands.

The command triggers an event and therefore has no query form and no \*RST value.

**Example:** "BB:W3GP:PPAR:EXEC"  
 'configures the signal sequence as defined by the :PPARAmeter commands.

*RST value	Resolution	Options	SCPI
-	-	B10/B11 and B13 K42 SOURce2 only with second option B9/B10/B11	Device-specific

**[SOURce<[1]|2>:]BB:W3GPP:PPARAmeter:SCCPch:SRATe**  
 D7K5 | D15K | D30K | D60K | D120K | D240K | D480K | D960K

The command sets the symbol rate of S-CCPCH.

The setting takes effect only after execution of command  
 [SOURce<[1]|2>:]BB:W3GPP:PPARAmeter:EXECute.

**Example:** "BB:W3GP:PPAR:SCCP:SRAT D240K"  
 'sets the SCCPCH to 240 ksps.

*RST value	Resolution	Options	SCPI
D30K	-	B10/B11 and B13 K42 SOURce2 only with second option B9/B10/B11	Device-specific

[SOURce<[1]|2>:]BB:W3GPp:PPARameter:SCCPch:STATe ON | OFF

The command activates/deactivates the S-CCPCH.

The setting takes effect only after execution of command  
[SOURce<[1]|2>:]BB:W3GPp:PPARameter:EXECute.

**Example:** "BB:W3GP:PPAR:SCCP:STAT ON"  
'S-CCPCH is activated.

*RST value	Resolution	Options	SCPI
OFF	-	B10/B11 and B13 K42 SOURce2 only with second option B9/B10/B11	Device-specific

[SOURce<[1]|2>:]BB:W3GPp:PPARameter:SCHannels ON | OFF

The command activates/deactivates the PCPICH, PSCH, SSCH and PCCPCH. These "special channels" are required by a user equipment for synchronization.

The setting takes effect only after execution of command  
[SOURce<[1]|2>:]BB:W3GPp:PPARameter:EXECute.

**Example:** "BB:W3GP:PPAR:SCH ON"  
'activates PCPICH, PSCH, SSCH and PCCPCH.

*RST value	Resolution	Options	SCPI
OFF	-	B10/B11 and B13 K42 SOURce2 only with second option B9/B10/B11	Device-specific

**[SOURce<[1]>:]BB:W3GPP:SETTing:TMODeI:BSTation <test\_model\_name>**

The command selects a test model defined by the standard for the downlink.

This command triggers an action and therefore has no \*RST value and no query form.

- Parameters:**
- Test\_Model\_1\_16channels  
'Measurement: Spectrum emission mask ACLR; 16 Channels
  - Test\_Model\_1\_32channels  
'Measurement: Spectrum emission mask ACLR; 32 Channels
  - Test\_Model\_1\_64channels  
'Measurement: Spectrum emission mask ACLR; 64 Channels
  - Test\_Model\_2  
'Measurement: Output power dynamics
  - Test\_Model\_3\_16channels  
'Measurement: Peak code domain error; 16 Channels
  - Test\_Model\_3\_32channels  
'Measurement: Peak code domain error; 32 Channels
  - Test\_Model\_4  
'Measurement: Error Vector Magnitude
  - Test\_Model\_5\_30\_8channels  
'Measurement: Error Vector Magnitude; 8 High Speed Channels
  - Test\_Model\_5\_14\_4channels  
'Measurement: Error Vector Magnitude; 4 High Speed Channels
  - Test\_Model\_5\_06\_2channels  
'Measurement: Error Vector Magnitude; 2 High Speed Channels

**Example:** "BB:W3GP:SETT:TMOD:BST 'Test\_Model\_1\_64channels'"  
'selects the test model 'Measurement: Spectrum emission mask ACLR; 64 Channels'

*RST value	Resolution	Options	SCPI
-	-	B10/B11 and B13 K42 SOURce2 only with second option B9/B10/B11	Device-specific

**[SOURce<[1]>:]BB:W3GPP:SETTing:TMODeI:BSTation:CATalog?**

The command queries the list of test models defined by the standard for the downlink.

The command is a query command and therefore does not have an \*RST value.

**Example:** "BB:W3GP:SETT:TMOD:BST:CAT?"  
'queries the list of available test models for the downlink transmission direction  
Response: "'Test\_Model\_1\_16channels, ..."

*RST value	Resolution	Options	SCPI
-	-	B10/B11 and B13 K42 SOURce2 only with second option B9/B10/B11	Device-specific

**[SOURce<[1]>:]BB:W3GPp:SETTing:TMODeI:MSTation <test\_model\_name>**

The command selects a test model that is not defined by the standard for the uplink.

This command triggers an action and therefore has no \*RST value and no query form.

**Parameters:** 'DPCCH\_DPDCH\_60kspS'  
 Preset, Uplink, UE1 on, DPDCH + DPCCH, Overall symbol rate 60 kspS  
 'DPCCH\_DPDCH960kspS'  
 Preset, Uplink, UE1 on, DPDCH + DPCCH, Overall symbol rate 960 kspS

**Example:** "BB:W3GP:SETT:TMOD:MST 'DPCCH\_DPDCH960kspS'"  
 'selects the test model with a symbol rate of 960 kspS.

*RST value	Resolution	Options	SCPI
-	-	B10/B11 and B13 K42 SOURce2 only with second option B9/B10/B11	Device-specific

**[SOURce<[1]>:]BB:W3GPp:SETTing:TMODeI:MSTation:CATalog?**

The command queries the list of non-standardized test models for the uplink.

The command is a query command and therefore does not have an \*RST value.

**Example:** "BB:W3GP:SETT:TMOD:MST:CAT?"  
 'queries the list of available test models  
 Response: .'"DPCCH\_DPDCH960kspS,DPCCH\_DPDCH\_60kspS'"

*RST value	Resolution	Options	SCPI
-	-	B10/B11 and B13 K42 SOURce2 only with second option B9/B10/B11	Device-specific

## SOURce:W3GPP - Setting Base Stations

The SOURce:BB:W3GPP:BSTation system contains commands for setting base stations. The commands of this system only take effect if the 3GPP FDD standard is activated, the DOWN transmission direction is selected and the particular base station is enabled:

SOURce:BB:W3GPP:STATE ON

SOURce:BB:W3GPP:LINK DOWN

SOURce:BB:W3GPP:BSTation2:STATE ON

### Important:

*In case of remote control, suffix counting for channels corresponds to the suffix counting with 3GPP FDD (channel 0 to channel 138). SCPI prescribes that suffix 1 is the default state and used when no specific suffix is specified. Therefore, channel 1 (and not channel 0) is selected when no suffix is specified.*

The commands for setting the enhanced channels of base station 1 are described in the following Section "[SOURce:W3GPP - Enhanced Channels of Base Station 1](#)", Page 6.533 .

Command	Parameters	Default unit	Comments
[SOURce<[1] 2>:]BB:W3GPP:BSTation<[1] 2 3 4>:CHANnel<n>:AICH:ASLOt	0...15		
[SOURce<[1] 2>:]BB:W3GPP:BSTation<[1] 2 3 4>:CHANnel<n>:APAIch:ASLOt	0...15		
[SOURce<[1] 2>:]BB:W3GPP:BSTation<[1] 2 3 4>:CHANnel<n>:AICH:SAPattern	<bit pattern>		
[SOURce<[1] 2>:]BB:W3GPP:BSTation<[1] 2 3 4>:CHANnel<n>:APAIch:SAPattern	<bit pattern>		
[SOURce<[1] 2>:]BB:W3GPP:BSTation<[1] 2 3 4>:CHANnel<n>:CCODE	0...(511) 0 ... 3.84/symbol rate		
[SOURce<[1] 2>:]BB:W3GPP:BSTation<[1] 2 3 4>:CHANnel<n>:DATA	PN9   PN15   PN16   PN20   PN21   PN23   ZERO   ONE   PATTERN   DLISt		
[SOURce<[1] 2>:]BB:W3GPP:BSTation<[1] 2 3 4>:CHANnel<n>:DATA:DSElect	<dlist_name>		
[SOURce<[1] 2>:]BB:W3GPP:BSTation<[1] 2 3 4>:CHANnel<n>:DATA:PATtern	#B0,1...B11..1,64		
[SOURce<[1] 2>:]BB:W3GPP:BSTation<[1] 2 3 4>:CHANnel<n>:DPCCh:MCODE	ON   OFF		
[SOURce<[1] 2>:]BB:W3GPP:BSTation<[1] 2 3 4>:CHANnel<n>:DPCCh:PLENght	BIT0   BIT2   BIT4   BIT8   BIT16		
[SOURce<[1] 2>:]BB:W3GPP:BSTation<[1] 2 3 4>:CHANnel<n>:DPCCh:POFFset:PILOt	-10 dB ... 10 dB		
[SOURce<[1] 2>:]BB:W3GPP:BSTation<[1] 2 3 4>:CHANnel<n>:DPCCh:POFFset:TFCl	-10 dB ... 10 dB		
[SOURce<[1] 2>:]BB:W3GPP:BSTation<[1] 2 3 4>:CHANnel<n>:DPCCh:POFFset:TPC	-10 dB ... 10 dB		
[SOURce<[1] 2>:]BB:W3GPP:BSTation<[1] 2 3 4>:CHANnel<n>:DPCCh:TFCl	0...1023		
[SOURce<[1] 2>:]BB:W3GPP:BSTation<[1] 2 3 4>:CHANnel<n>:DPCCh:TFCl:STATE	ON   OFF		



Command	Parameters	Default unit	Comments
[SOURce<[1] 2>:]BB:W3GPP:BSTation<[1] 2 3 4>:CHANnel<n>:DPCCh:TPC:DATA	DLISt   ZERO   ONE  PATTern		
[SOURce<[1] 2>:]BB:W3GPP:BSTation<[1] 2 3 4>:CHANnel<n>:DPCCh:TPC:DATA:DSElect	<list_name>		
[SOURce<[1] 2>:]BB:W3GPP:BSTation<[1] 2 3 4>:CHANnel<n>:DPCCh:TPC:DATA:PATTern	#B0,1...B11..1,64		
[SOURce<[1] 2>:]BB:W3GPP:BSTation<[1] 2 3 4>:CHANnel<n>:DPCCh:TPC:MISuse	ON   OFF		
[SOURce<[1] 2>:]BB:W3GPP:BSTation<[1] 2 3 4>:CHANnel<n>:DPCCh:TPC:PSTep	-10 dB ...+10 dB	dB	
[SOURce<[1] 2>:]BB:W3GPP:BSTation<[1] 2 3 4>:CHANnel<n>:DPCCh:TPC:READ	CONTInuous   S0A   S1A   S01A   S10A		
[SOURce<[1] 2>:]BB:W3GPP:BSTation<[1] 2 3 4>:CHANnel<n>:FDPCh:DP CCh:TPC:DATA -	DLISt   ZERO   ONE  PATTern		
[SOURce<[1] 2>:]BB:W3GPP:BSTation<[1] 2 3 4>:CHANnel<n>:FDPCh:DP CCh:TPC:DATA : DSElect	<list_name>		
[SOURce<[1] 2>:]BB:W3GPP:BSTation<[1] 2 3 4>:CHANnel<n>:FDPCh:DP CCh:TPC:DATA PATT	#B0,1...B11..1,64		
[SOURce<[1] 2>:]BB:W3GPP:BSTation<[1] 2 3 4>:CHANnel<n>:FDPhC:DP CCh:TPC:MISuse: ON	ON   OFF		
[SOURce<[1] 2>:]BB:W3GPP:BSTation<[1] 2 3 4>:CHANnel<n>:FDPhC:DP CCh:TPC:PSTep	-10 dB ...+10 dB	dB	
[SOURce<[1] 2>:]BB:W3GPP:BSTation<[1] 2 3 4>:CHANnel<n>:FDPhC:DP CCh:TPC:READ	CONTInuous   S0A   S1A   S01A   S10A		
[SOURce<[1] 2>:]BB:W3GPP:BSTation:CHANnel:HSDPa:HSET:PRESet			No query
[SOURce<[1] 2>:]BB:W3GPP:BSTation<[1] 2 3 4>:CHANnel<n>:HSDPa:BMODE[:STATE]	ON   OFF		
[SOURce<[1] 2>:]BB:W3GPP:BSTation:CHANnel:HSDPa:BPAYload			Query only
[SOURce<[1] 2>:]BB:W3GPP:BSTation:CHANnel:HSDPa:CLENgth			Query only
[SOURce<[1] 2>:]BB:W3GPP:BSTation<[1] 2 3 4>:CHANnel<n>:HSDPa:CV PB	0,1,2,3		
[SOURce<[1] 2>:]BB:W3GPP:BSTation:CHANnel:HSDPa:HARQ:LENgth			Query only
[SOURce<[1] 2>:]BB:W3GPP:BSTation:CHANnel:HSDPa:HSET	1 ... 5		
[SOURce<[1] 2>:]BB:W3GPP:BSTation<[1] 2 3 4>:CHANnel<n>:HSDPa:MODE	CONTInuous   PSF0   PSF1   PSF2   PSF3   PSF4   HSET		
[SOURce<[1] 2>:]BB:W3GPP:BSTation:CHANnel:HSDPa:NAIBitrate			Query only
[SOURce<[1] 2>:]BB:W3GPP:BSTation:CHANnel:HSDPa:PRSR			Query only
[SOURce<[1] 2>:]BB:W3GPP:BSTation:CHANnel:HSDPa:PSBS			Query only
[SOURce<[1] 2>:]BB:W3GPP:BSTation:CHANnel:HSDPa:RVParameter	0 ... 7		
[SOURce<[1] 2>:]BB:W3GPP:BSTation:CHANnel:HSDPa:SFORmat	0   1		
[SOURce<[1] 2>:]BB:W3GPP:BSTation:CHANnel:HSDPa:UEID	0 ... 65535		
[SOURce<[1] 2>:]BB:W3GPP:BSTation<[1] 2 3 4>:CHANnel<n>:HSDPa:TT IDistanc	1...16 slots		
[SOURce<[1] 2>:]BB:W3GPP:BSTation<[1] 2 3 4>:CHANnel<n>:HSUPa:EH ICh:CTYPe	SERV   NOSER		
[SOURce<[1] 2>:]BB:W3GPP:BSTation<[1] 2 3 4>:CHANnel<n>:HSUPa:EH ICh:DTAU	0...149		
[SOURce<[1] 2>:]BB:W3GPP:BSTation<[1] 2 3 4>:CHANnel<n>:HSUPa:EH ICh:ETAU	0...149		
[SOURce<[1] 2>:]BB:W3GPP:BSTation<[1] 2 3 4>:CHANnel<n>:HSUPa:EH ICh:RGPattern	<bit pattern>		

Command	Parameters	Default unit	Comments
[SOURce<[1] 2>:]BB:W3GPP:BSTation<[1] 2 3 4>:CHANnel<n>:HSUPa:EH ICh:SSINdex	0..39		
[SOURce<[1] 2>:]BB:W3GPP:BSTation<[1] 2 3 4>:CHANnel<n>:HSUPa:EH ICh:TTIEdch	2   10	ms	
[SOURce<[1] 2>:]BB:W3GPP:BSTation<[1] 2 3 4>:CHANnel<n>:HSUPa:ER GCh:CTYPe	SER   NOSER		
[SOURce<[1] 2>:]BB:W3GPP:BSTation<[1] 2 3 4>:CHANnel<n>:HSUPa:ER GCh:DTAU	0...149		
[SOURce<[1] 2>:]BB:W3GPP:BSTation<[1] 2 3 4>:CHANnel<n>:HSUPa:ER GCh:ETAU	0...149		
[SOURce<[1] 2>:]BB:W3GPP:BSTation<[1] 2 3 4>:CHANnel<n>:HSUPa:ER GCh:RGPAattern	<bit pattern>		
[SOURce<[1] 2>:]BB:W3GPP:BSTation<[1] 2 3 4>:CHANnel<n>:HSUPa:ER GCh:SSINdex	0...39		
[SOURce<[1] 2>:]BB:W3GPP:BSTation<[1] 2 3 4>:CHANnel<n>:HSUPa:ER GCh:TTIEdch	2   10	ms	
[SOURce<[1] 2>:]BB:W3GPP:BSTation<[1] 2 3 4>:CHANnel<n>:POWER	-80 dB ... 0 dB	dB	
[SOURce<[1] 2>:]BB:W3GPP:BSTation:CHANnel:PRESet			No query
[SOURce<[1] 2>:]BB:W3GPP:BSTation<[1] 2 3 4>:CHANnel<n>:SFORmat	<numeric_value>		
[SOURce<[1] 2>:]BB:W3GPP:BSTation<[1] 2 3 4>:CHANnel<n>:SRATE	D7K5   D15K   D30K   D60K   D120K   D240K   D480K   D960K (S/s)		
[SOURce<[1] 2>:]BB:W3GPP:BSTation<[1] 2 3 4>:CHANnel<n>:STATe	ON   OFF		
[SOURce<[1] 2>:]BB:W3GPP:BSTation<[1] 2 3 4>:CHANnel<n>:TOFFset	0...149		
[SOURce<[1] 2>:]BB:W3GPP:BSTation<[1] 2 3 4>:CHANnel<n>:TYPE	PCPich   SCPich   PSCH   SSCH   PCCPch   SCCPch   PICH   APAich   AICH   PDSch   DPCCh   DPCH   HSSCch   HPQPsk   HPQam16		
[SOURce<[1] 2>:]BB:W3GPP:BSTation<2 3 4>:CMODE:DLFStructure	A   B		
[SOURce<[1] 2>:]BB:W3GPP:BSTation<2 3 4>:CMODE:METHod	HLSScheduling   PUNCTuring   SF2		
[SOURce<[1] 2>:]BB:W3GPP:BSTation<2 3 4>:CMODE:PATTern<[1] 2>:T GD	3...100 slots		
[SOURce<[1] 2>:]BB:W3GPP:BSTation<2 3 4>:CMODE:PATTern<[1] 2>:T GL<[1] 2>	3...14 slots		
[SOURce<[1] 2>:]BB:W3GPP:BSTation<2 3 4>:CMODE:PATTern<[1] 2>:T GPL	1(0) ... 100 frames		
[SOURce<[1] 2>:]BB:W3GPP:BSTation<2 3 4>:CMODE:PATTern<[1] 2>:T GSN	Slot 0 ...slot 14		
[SOURce<[1] 2>:]BB:W3GPP:BSTation<2 3 4>:CMODE:POFFset	0 dB ... 10 dB		
[SOURce<[1] 2>:]BB:W3GPP:BSTation<2 3 4>:CMODE:POMode	AUTO   USER		
[SOURce<[1] 2>:]BB:W3GPP:BSTation<2 3 4>:CMODE:STATe	ON   OFF		
[SOURce<[1] 2>:]BB:W3GPP:BSTation<[1] 2 3 4>:DCONflict:RESolve			No query
[SOURce<[1] 2>:]BB:W3GPP:BSTation<[1] 2 3 4>:DCONflict[:STATe]			Query only
[SOURce<[1] 2>:]BB:W3GPP:BSTation:OCNS:MODE	STANdard   HSDPa		BS1 only
[SOURce<[1] 2>:]BB:W3GPP:BSTation:OCNS:STATe	ON   OFF		BS1 only
[SOURce<[1] 2>:]BB:W3GPP:BSTation<[1] 2 3 4>:PINDicator:COUNt	D18   D36   D72   D144		
[SOURce<[1] 2>:]BB:W3GPP:BSTation:PRESet			
[SOURce<[1] 2>:]BB:W3GPP:BSTation<[1] 2 3 4>:SCODE	#H0...#H5FFF		

Command	Parameters	Default unit	Comments
[SOURce<[1]>:]BB:W3GPp:BSTation<[1]>:SCODE:STAtE	ON   OFF		
[SOURce<[1]>:]BB:W3GPp:BSTation<[1]>:SCPich:PREFere[n]ce[:STAtE]	ON   OFF		
[SOURce<[1]>:]BB:W3GPp:BSTation<[1]>:SSCG?	Answer: 0...63		Query only
[SOURce<[1]>:]BB:W3GPp:BSTation<[1]>:STAtE	ON   OFF		
[SOURce<[1]>:]BB:W3GPp:BSTation<[1]>:TDELay	0...38400 chips		
[SOURce<[1]>:]BB:W3GPp:BSTation<[1]>:TDIVersity	OFF   ANT1   ANT2		

**[SOURce<[1]>:]BB:W3GPp:BSTation<[1]>:CHANnel7:AICH:ASLOt 0 ... 15**

The command selects the slot in which the burst is transmitted.

**Example:** "BB:W3GP:BST1:CHAN7:AICH:ASLO 5"  
'defines the slot to transmit the burst.

*RST value	Resolution	Options	SCPI
0	-	B10/B11 and B13 K42 SOURce2 only with second option B9/B10/B11	Device-specific

**[SOURce<[1]>:]BB:W3GPp:BSTation<[1]>:CHANnel7:APAIch:ASLOt 0 ... 15**

The command selects the slot in which the burst is transmitted.

**Example:** "BB:W3GP:BST1:CHAN7:APAI:ASLO 5"  
'defines the slot to transmit the burst.

*RST value	Resolution	Options	SCPI
0	-	B10/B11 and B13 K42 SOURce2 only with second option B9/B10/B11	Device-specific

**[SOURce<[1]>:]BB:W3GPp:BSTation<[1]>:CHANnel7:AICH:SAPAttern <bit pattern>**

Enters the 16 bit pattern for the ACK/NACK field. This field is used by the base station to acknowledge, refuse or ignore requests of up to 16 user equipments.

**Example:** "SOUR:BB:W3GP:BST1:CHAN7:AICH:SAP "+0000000000000000"  
'sets the bit pattern to "+0000000000000000" (ACK).

*RST value	Resolution	Options	SCPI
"+0000000000000000"	-	B10/B11 and B13 K42 SOURce2 only with second option B9/B10/B11	Device-specific

[SOURce<[1]|2>:]BB:W3GPP:BSTation<[1]|2|3|4>:CHANnel8:APAIch:SAPattern <bit pattern>

Enters the 16 bit pattern for the ACK/NACK field. This field is used by the base station to acknowledge, refuse or ignore requests of up to 16 user equipments.

**Example:** "SOUR:BB:W3GP:BST1:CHAN8:APAI:SAP "+000000000000""  
 'sets the bit pattern to "+" (ACK).

*RST value	Resolution	Options	SCPI
"+000000000000"	-	B10/B11 and B13 K42 SOURce2 only with second option B9/B10/B11	Device-specific

[SOURce<[1]|2>:]BB:W3GPP:BSTation<[1]|2|3|4>:CHANnel<0|[1]|2|5...138>>:CCODE 0 ... 511

The command sets the channelization code (formerly the spreading code number). The range of values of the channelization code depends on the symbol rate of the channel. The standard assigns a fixed channelization code to some channels (P-CPICH, for example, always uses channelization code 0).  $\frac{chip\_rate(=3.84Mcps)}{symbol\_rate} - 1$

**Example:** "BB:W3GP:BST1:CHAN15:CCOD 123"  
 'sets channelization code 123 for channel 15 of base station 1.

*RST value	Res.	Options	Dependency	SCPI
Depends on the channel type.	1	B10/B11 and B13 K42 SOURce2 only with second option B9/B10/B11	The slot format determines the symbol rate (and thus the range of values for the channelization code), the TFCI state and the pilot length. If the value of any one of the four parameters is changed, all the other parameters will be adapted as necessary.  In the case of enhanced channels with active channel coding, the selected channel coding also affects the slot format and thus the remaining parameters. If these parameters are changed, the channel coding type is set to user.	Device-specific

**[SOURce<[1]|2>:]BB:W3GPP:BSTation<[1]|2|3|4>:CHANnel<4|5|6|9|11...138>:DATA  
PN9 | PN15 | PN16 | PN20 | PN21 | PN23 | DLIS | ZERO | ONE | PATTErn**

The command determines the data source for the data fields of the specified channel.

For enhanced channels with channel coding, the data source is set with the command  
:BB:W3GPP:BST:ENHanced:CHANnel<n>:DPCH:TCHannel<n>:DATA .

**Parameters:**      **PNxx**  
The pseudo-random sequence generator is used as the data source. Different random sequence lengths can be selected.

**DLIS**  
A data list is used. The data list is selected with the command  
:BB:W3GPP:BST:CHANnel:DATA:DSElect.

**ZERO | ONE**  
Internal 0 and 1 data is used.

**PATTErn**  
Internal data is used The bit pattern for the data is defined by the command  
:BB:W3GPP:BST:CHANnel:DATA:PATTErn

**Example:**      "BB:W3GP:BST2:CHAN13:DATA PATT"  
'selects as the data source for the data fields of channel 13 of base station 2, the bit pattern defined with the following command.  
  
"BB:W3GP:BST2:CHAN13:DATA:PATT #H3F,8"  
'defines the bit pattern.

*RST value	Resolution	Options	SCPI
PN9	-	B10/B11 and B13 K42 SOURce2 only with second option B9/B10/B11	Device-specific

**[SOURce<[1]|2>:]BB:W3GPP:BSTation<[1]|2|3|4>:CHANnel<4|5|6|9|11...138>:DATA:DSElect  
<data list name>**

The command selects the data list for the DLIS data source selection.

The lists are stored as files with the fixed file extensions \*.dm\_iqd in a directory of the user's choice. The directory applicable to the following commands is defined with the command MMEMory:CDIR. To access the files in this directory, you only have to give the file name, without the path and the file extension.

**Example:**      "BB:W3GP:BST2:CHAN13:DATA DLIS"  
'selects the Data Lists data source.  
  
"MMEM:CDIR 'D:\Lists\DM\IqData'"  
'selects the directory for the data lists.  
  
"BB:W3GP:BST2:CHAN13:DATA:DLIS '3gpp\_list1'"  
'selects file '3gpp\_list1' as the data source. This file must be in the directory D:\Lists\DM\IqData and have the file extension \*.dm\_iqd.

*RST value	Resolution	Options	SCPI
-	-	B10/B11 and B13 K42 SOURce2 only with second option B9/B10/B11	Device-specific

**[SOURce<[1]|2>:]BB:W3GPP:BSTation<[1]|2|3|4>:CHANnel<4|5|6|9|11...138>:DATA:PATtern**  
 #B0,1... #B111..1,64

The command determines the bit pattern for the PATtern selection. The maximum length is 64 bits.

**Example:** "BB:W3GP:BST2:CHAN13:DATA:PATT #H3F,8"  
 'defines the bit pattern.

*RST value	Resolution	Options	SCPI
0	-	B10/B11 and B13 K42 SOURce2 only with second option B9/B10/B11	Device-specific

**[SOURce<[1]|2>:]BB:W3GPP:BSTation<[1]|2|3|4>:CHANnel<11...138>:DPCCh:MCODe ON | OFF**

The command activates multicode transmission for the selected channel (ON) or deactivates it (OFF). The multicode channels are destined for the same receiver, that is to say, are part of a radio link. The first channel of this group is used as the master channel. The common components (Pilot, TPC and TCFI) for all the channels are then spread using the spreading code of the master channel.

This setting is only valid for DPCHs (CHANnel111...138).

**Example:** "BB:W3GP:BST2:CHAN12:DPCC:MCOD ON"  
 'activates the simulation in multicode mode for channel 12 of base station 2.

"BB:W3GP:BST2:CHAN13:DPCC:MCOD ON"  
 'activates the simulation in multicode mode for channel 13 of base station 2.  
 Channel 12 is the master channel.

*RST value	Resolution	Options	SCPI
OFF	-	B10/B11 and B13 K42 SOURce2 only with second option B9/B10/B11	Device-specific

**[SOURce<[1]|2>:]BB:W3GPP:BSTation<[1]|2|3|4>:CHANnel<5|10...138>:DPCCh:PLENght**  
 BIT0 | BIT2 | BIT4 | BIT8 | BIT16

The command sets the length of the pilot fields. The range of values for this parameter depends on the channel type and the symbol rate. To achieve a constant slot length, the data fields are lengthened or shortened depending on the pilot length, as defined in the standard.

**Example:** "BB:W3GP:BST2:CHAN12:DPCC:PLEN BIT2"  
 'sets the length of the pilot fields for channel 12 of base station 2.

*RST value	Res.	Options	Dependency	SCPI
BIT4	-	B10/B11 and B13 K42 SOURce2 only with second option B9/B10/B11	The slot format determines the symbol rate (and thus the range of values for the channelization code), the TFCI state and the pilot length. If the value of any one of the four parameters is changed, all the other parameters will be adapted as necessary.  In the case of enhanced channels with active channel coding, the selected channel coding also affects the slot format and thus the remaining parameters. If these parameters are changed, the channel coding type is set to user.	Device-specific

[SOURce<[1]|2>:]BB:W3GPp:BSTation<[1]|2|3|4>:CHANnel<5|10...138>:DPCC:h:POFFset:PILot  
-10 dB ... +10 dB

The command sets an offset to the set channel power for the pilot field.

**Example:** "BB:W3GP:BST2:CHAN12:DPCC:POFF:PIL -2 dB"  
'in the pilot field, sets an offset of -2 dB relative to the channel power.

*RST value	Resolution	Options	SCPI
0	0.1 dB	B10/B11 and B13 K42 SOURce2 only with second option B9/B10/B11	Device-specific

[SOURce<[1]|2>:]BB:W3GPp:BSTation<[1]|2|3|4>:CHANnel<5|8...138>:DPCC:h:POFFset:TFCI  
-10 dB ... +10 dB

The command sets an offset to the set channel power for the TFCI field.

This setting is only valid for the DPCHs.

**Example:** "BB:W3GP:BST2:CHAN12:DPCC:POFF:PIL -2 dB"  
'in the TFCI field, sets an offset of -2 dB relative to the channel power.

*RST value	Resolution	Options	SCPI
0	0.01 dB	B10/B11 and B13 K42 SOURce2 only with second option B9/B10/B11	Device-specific

[SOURce<[1]|2>:]BB:W3GPp:BSTation<[1]|2|3|4>:CHANnel<10...138>:DPCC:h:POFFset:TPC  
-10 dB ... +10 dB

The command sets an offset to the set channel power for the TPC field.

This setting is only valid for the DPCHs.

**Example:** "BB:W3GP:BST2:CHAN12:DPCC:POFF:TPC -2 dB"  
'in the TPC field, sets an offset of -2 dB relative to the channel power.

*RST value	Resolution	Options	SCPI
0	0.01 dB	B10/B11 and B13 K42 SOURce2 only with second option B9/B10/B11	Device-specific

[SOURce<[1]|2>:]BB:W3GPP:BSTation<[1]|2|3|4>:CHANnel<5|9...138>:DPCCh:TFCI 0...1023

The command enters the value of the TFCI field (Transport Format Combination Indicator) for the selected channel of the specified base station. The TFCI field is always filled with exactly 10 bits with leading zeros.

**Example:** "BB:W3GP:BST2:CHAN12:DPCC:TFCI 22"  
 'sets the value 22 for the TFCI field of channel 12 of base station 2.

*RST value	Resolution	Options	SCPI
0	1	B10/B11 and B13 K42 SOURce2 only with second option B9/B10/B11	Device-specific

[SOURce<[1]|2>:]BB:W3GPP:BSTation<[1]|2|3|4>:CHANnel<5|9...138>:DPCCh:TFCI:STATe ON|OFF

The command activates the TFCI field (Transport Format Combination Identifier) for the selected channel of the specified base station.

**Example:** "BB:W3GP:BST2:CHAN12:DPCC:TFCI:STAT OFF"  
 'sets that the TFCI field of channel 12 of base station 2 is not used.

*RST value	Res.	Options	Dependency	SCPI
OFF	-	B10/B11 and B13 K42 SOURce2 only with second option B9/B10/B11	The slot format determines the symbol rate (and thus the range of values for the channelization code), the TFCI state and the pilot length. If the value of any one of the four parameters is changed, all the other parameters will be adapted as necessary.  In the case of enhanced channels with active channel coding, the selected channel coding also affects the slot format and thus the remaining parameters. If these parameters are changed, the channel coding type is set to user.	Device-specific



[SOURCE<[1]|2>:]BB:W3GPP:BSTation<[1]|2|3|4>:CHANNEL<10...138>:DPCCh:TPC:DATA  
DLIS | ZERO | ONE | PATTERN

The command determines the data source for the TPC field of the channel.

**Parameters:**     **DLIS**

A data list is used. The data list is selected with the command  
BB:W3GPP:BST:CHANNEL:DPCCh:TPC:DATA:DSEL.

**ZERO | ONE**

Internal 0 and 1 data is used.

**PATTERN**

Internal data is used. The bit pattern for the data is defined by the command  
BB:W3GPP:BST:CHANNEL:DPCCh:TPC:DATA:PATTERN. The maximum  
length is 32 bits.

**Example:**

"BB:W3GP:BST2:CHAN13:DPCC:TPC:DATA PATT"

'selects as the data source for the TPC field of channel 13 of base station 2,  
the bit pattern defined with the following command.

"BB:W3GP:BST2:CHAN13:DPCC:TPC:DATA:PATT #H3F, 8"

'defines the bit pattern.

*RST value	Resolution	Options	SCPI
PATTERN	-	B10/B11 and B13 K42 SOURCE2 only with second option B9/B10/B11	Device-specific

[SOURCE<[1]|2>:]BB:W3GPP:BSTation<[1]|2|3|4>:CHANNEL<10...138>:DPCCh:TPC:DATA:DSElect  
<data list name>

The command selects the data list for the DLIS data source selection.

The lists are stored as files with the fixed file extensions \*.dm\_iqd in a directory of the user's choice. The directory applicable to the following commands is defined with the command MMEMoRY:CDIR. To access the files in this directory, you only have to give the file name, without the path and the file extension.

**Example:**

"BB:W3GP:BST2:CHAN13:DPCC:TPC:DATA DLIS"

'selects the "Data Lists" data source.

"MMEM:CDIR 'D:\Lists\DM\IqData'"

'selects the directory for the data lists.

"BB:W3GP:BST2:CHAN13:DPCC:TPC:DATA:DSEL 'tpc\_ch4'"

'selects the file 'tpc\_ch4' as the data source. This file must be in the directory  
D:\Lists\DM\IqData and have the file extension \*.dm\_iqd.

*RST value	Resolution	Options	SCPI
-	-	B10/B11 and B13 K42 SOURCE2 only with second option B9/B10/B11	Device-specific

[SOURce<[1]|2>:]BB:W3GPP:BSTation<[1]|2|3|4>:CHANnel<10...138>:DPCCh:TPC:DATA:PATtern #B0,1 ... #B111..1,64

The command determines the bit pattern for the PATtern selection. The maximum bit pattern length is 32 bits.

**Example:** "BB:W3GP:BST2:CHAN13:DPCC:TPC:DATA:PATT #H3F, 8"  
'defines the bit pattern for the TPC field of channel 13 of base station 2.

*RST value	Resolution	Options	SCPI
#H0,1	-	B10/B11 and B13 K42 SOURce2 only with second option B9/B10/B11	Device-specific

[SOURce<[1]|2>:]BB:W3GPP:BSTation<[1]|2|3|4>:CHANnel<10...138>:DPCCh:TPC:MISuse ON|OFF

The command activates "mis-" use of the TPC field (Transmit Power Control) of the selected channel for controlling the channel powers of these channels of the specified base station.

The bit pattern (see commands :W3GPP:BSTation<n>:CHANnel<n>:DPCCh:TPC...) of the TPC field of each channel is used to control the channel power. A "1" leads to an increase of channel powers, a "0" to a reduction of channel powers. Channel power is limited to the range 0 dB to -80 dB. The step width of the change is defined with the command :W3GPP:BSTation<n>:CHANnel<n>:DPCCh:TPC:PSTep.

**Example:** "BB:W3GP:BST2:CHAN13:DPCC:TPC:MIS ON"  
'activates regulation of channel power for channel 13 of base station 2 via the bit pattern of the associated TPC field.  
"BB:W3GP:BST2:CHAN13:DPCC:TPC:PST 1 dB"  
'sets the step width for the change of channel powers for channel 13 of base station 2 to 1 dB.

*RST value	Resolution	Options	SCPI
OFF	-	B10/B11 and B13 K42 SOURce2 only with second option B9/B10/B11	Device-specific

[SOURce<[1]|2>:]BB:W3GPP:BSTation<[1]|2|3|4>:CHANnel<10...138>:DPCCh:TPC:PSTep -10.0 ... 10.0 dB

The command defines the step width for the change of channel powers in the case of "mis-" use of the TPC field.

**Example:** "BB:W3GP:BST2:CHAN13:DPCC:TPC:PST 1 dB"  
'sets the step width for the change of channel powers for channel 13 of base station 2 to 1 dB.

*RST value	Resolution	Options	SCPI
0	0.01 dB	B10/B11 and B13 K42 SOURce2 only with second option B9/B10/B11	Device-specific

[SOURce<[1]|2>:]BB:W3GPp:BSTation<[1]|2|3|4>:CHANnel<10...138>:DPCCh:TPC:READ  
 CONTInuous | S0A | S1A | S01A | S10A

The command sets the read out mode for the bit pattern of the TPC field.

The bit pattern is defined with the commands :BB:W3GPp:BST<i>:CHANnel<n>:DPCCh:TPC... .

**Parameters:**

**CONTInuous**

The bit pattern is used cyclically.

**S0A**

The bit pattern is used once, then the TPC sequence continues with 0 bits.

**S1A**

The bit pattern is used once, then the TPC sequence continues with 1 bits.

**S01A**

The bit pattern is used once and then the TPC sequence is continued with 0 and 1 bits alternately (in multiples, depending on by the symbol rate, for example, 00001111).

**S10A**

The bit pattern is used once and then the TPC sequence is continued with 1 and 0 bits alternately (in multiples, depending on by the symbol rate, for example, 11110000).

**Example:**

"BB:W3GP:BST2:CHAN13:DPCCh:TPC:READ S0A"

'the bit pattern is used once, after which a 0 sequence is generated (applies to channel 13 of base station 2).

*RST value	Resolution	Options	SCPI
CONTInuous		B10/B11 and B13 K42 SOURce2 only with second option B9/B10/B11	Device-specific

**[SOURce<[1]|2>:]BB:W3GPP:BSTation<[1]|2|3|4>:CHANnel<11...138>:FDPCh:DPCCCh:TPC:DATA  
DLIS | ZERO | ONE | PATTern**

The command determines the data source for the TPC field of the channel.

**Parameters: DLIS**

A data list is used. The data list is selected with the command  
BB:W3GP:BST1:CHAN11:FDPC:DPCC:TPC:DATA:DSEL

**ZERO | ONE**

Internal 0 and 1 data is used.

**PATTern**

Internal data is used. The bit pattern for the data is defined by the command  
BB:W3GP:BST1:CHAN11:FDPC:DPCC:TPC:DATA:PATT.  
The maximum length is 32 bits.

**Example:**

"BB:W3GP:BST1:CHAN11:FDPC:DPCC:TPC:DATA PATT"  
'selects as the data source for the TPC field of channel 11 of base station 1,  
the bit pattern defined with the following command:  
"BB:W3GP:BST1:CHAN11:FDPC:DPCC:TPC:DATA:PATT #H3F,8"  
'defines the bit pattern.

*RST value	Resolution	Options	SCPI
PATTern	-	B10/B11 and B13 K42 SOURce2 only with second option B9/B10/B11	Device-specific

**[SOURce<[1]|2>:]BB:W3GPP:BSTation<[1]|2|3|4>:CHANnel<11...138>:FDPCh:DPCCCh:TPC:DATA:DS  
ELect <data list name>**

The command selects the data list for the DLIS data source selection.

The lists are stored as files with the fixed file extensions \*.dm\_iqd in a directory of the user's choice. The directory applicable to the following commands is defined with the command MMEMory:CDIR. To access the files in this directory, you only have to give the file name, without the path and the file extension.

**Example:**

"BB:W3GP:BST1:CHAN11:FDPC:DPCC:TPC:DATA DLIS"  
'selects the "Data Lists" data source.  
"MMEM:CDIR 'D:\Lists\DM\IqData'"  
'selects the directory for the data lists.  
"BB:W3GP:BST1:CHAN11:FDPC:DPCC:TPC:DATA:DSEL 'tpc\_ch4'"  
'selects the file 'tpc\_ch4' as the data source. This file must be in the directory  
D:\Lists\DM\IqData and have the file extension \*.dm\_iqd.

*RST value	Resolution	Options	SCPI
-	-	B10/B11 and B13 K42 SOURce2 only with second option B9/B10/B11	Device-specific

[SOURce<[1]|2>:]BB:W3Gp:BSTation<[1]|2|3|4>:CHANnel<11...138>:FDPCh:DPCCh:TPC:DATA:PA  
TTern #B0,1 ... #B111..1,64

The command determines the bit pattern for the PATtern selection. The maximum bit pattern length is 32 bits.

**Example:** "BB:W3GP:BST1:CHAN11:FDPC:DPCC:TPC:DATA:PATT #H3F, 8"  
'defines the bit pattern for the TPC field of channel 11 of base station 1.

*RST value	Resolution	Options	SCPI
#H0,1	-	B10/B11 and B13 K42 SOURce2 only with second option B9/B10/B11	Device-specific

[SOURce<[1]|2>:]BB:W3Gp:BSTation<[1]|2|3|4>:CHANnel<11...138>:FDPCh:DPCCh:TPC:MISuse  
ON|OFF

The command activates "mis-" use of the TPC field (Transmit Power Control) of the selected channel for controlling the channel powers of these channels of the specified base station.

The bit pattern (see commands

BB:W3GP:BSTation:CHANnel<n>:FDPCh:DPCCh:TPC:DATA:PA TTern) of the TPC field of each channel is used to control the channel power. A "1" leads to an increase of channel powers, a "0" to a reduction of channel powers. Channel power is limited to the range 0 dB to -80 dB. The step width of the change is defined with the command

BB::W3Gp:BSTation<n>:CHANnel<n>:FDPCh:DPCCh:TPC:PSTep.

**Example:** "BB:W3GP:BST1:CHAN11:FDPC:DPCC:TPC:MIS ON"  
'activates regulation of channel power for channel 11 of base station 1 via the bit pattern of the associated TPC field.

"BB:W3GP:BST1:CHAN11:FDPC:DPCC:TPC:PST 1dB"  
'sets the step width for the change of channel powers for channel 11 of base station 1 to 1 dB.

*RST value	Resolution	Options	SCPI
OFF	-	B10/B11 and B13 K42 SOURce2 only with second option B9/B10/B11	Device-specific

[SOURce<[1]|2>:]BB:W3GPP:BSTation<[1]|2|3|4>:CHANnel<11...138>:FDPCh:DPCCh:TPC:PSTep  
-10.0 ... 10.0 dB

The command defines the step width for the change of channel powers in the case of "mis-" use of the TPC field.

**Example:** "BB:W3GP:BST1:CHAN11:FDPC:DPC:TPC:PST 1.5dB"  
'sets the step width for the change of channel powers for channel 11 of base station 1 to 1.5 dB.

*RST value	Resolution	Options	SCPI
0	0.01 dB	B10/B11 and B13 K42 SOURce2 only with second option B9/B10/B11	Device-specific

[SOURce<[1]|2>:]BB:W3GPP:BSTation<[1]|2|3|4>:CHANnel<11...138>:FDPCh:DPCCh:TPC:READ  
CONTinuous | S0A | S1A | S01A | S10A

The command sets the read out mode for the bit pattern of the TPC field.

- Parameters:**
- CONTinuous**  
The bit pattern is used cyclically.
  - S0A**  
The bit pattern is used once, then the TPC sequence continues with 0 bits.
  - S1A**  
The bit pattern is used once, then the TPC sequence continues with 1 bits.
  - S01A**  
The bit pattern is used once and then the TPC sequence is continued with 0 and 1 bits alternately (in multiples, depending on by the symbol rate, for example, 00001111).
  - S10A**  
The bit pattern is used once and then the TPC sequence is continued with 1 and 0 bits alternately (in multiples, depending on by the symbol rate, for example, 11110000).

**Example:** "BB:W3GP:BST1:CHAN11:FDPC:DPC:TPC:READ S0A"  
'the bit pattern is used once, after which a 0 sequence is generated (applies to channel 11 of base station 1).

*RST value	Resolution	Options	SCPI
CONTinuous		B10/B11 and B13 K42 SOURce2 only with second option B9/B10/B11	Device-specific

**[SOURce<[1]|2>:]BB:W3GPp:BSTation<[1]|2|3|4>:CHANnel<9...138>:HSDPa:BMODE[:STATe]  
ON | OFF**

The command activates/deactivates burst mode. The signal is bursted when on, otherwise dummy data are sent during transmission brakes.

**Example:** "BB:W3GP:BST1:CHAN12:HSDP:BMOD OFF"  
'deactivates burst mode, dummy data are sent during the transmission brakes

*RST value	Resolution	Options	SCPI
ON	-	B10/B11 and B13 K42 SOURce2 only with second option B9/B10/B11	Device-specific

**[SOURce<[1]|2>:]BB:W3GPp:BSTation1:CHANnel12:HSDPa:BPAYload?**

The command queries the payload of the information bit. This value determines the number of transport layer bits sent in each subframe. This command is query only and therefore has no \*RST value.

**Example:** "BB:W3GP:BST1:CHAN12:HSDP:MODE HSET"  
'selects H-Set mode.

"BB:W3GP:BST1:CHAN12:HSDP:BPAY?"  
'queries the payload of the information bit.

Response: "256"

*RST value	Resolution	Options	SCPI
-	-	B10/B11 and B13 K42 SOURce2 only with second option B9/B10/B11	Device-specific

**[SOURce<[1]|2>:]BB:W3GPp:BSTation1:CHANnel12:HSDPa:CLENght?**

The command queries the number of physical HS-PDSCH data channels assigned to the HS-SCCH. This command is query only and therefore has no \*RST value.

**Example:** "BB:W3GP:BST1:CHAN12:HSDP:MODE HSET"  
'selects H-Set mode.

"BB:W3GP:BST1:CHAN12:HSDP:CLEN?"  
'queries the number of physical HS-PDSCH data channels assigned to the HS-SCCH.

Response: "4"

*RST value	Resolution	Options	SCPI
-	-	B10/B11 and B13 K42 SOURce2 only with second option B9/B10/B11	Device-specific

[SOURce<[1]|2>:]BB:W3GPP:BSTation<[1]|2|3|4>:CHANnel<11...138>:HSDPa:CVPB 0 | 1 | 2 | 3

The command switches the order of the constellation points of the QAM16 mapping. When HSDPA mode HSET (BB:W3GP:BST:CHAN:HSDP:MODE HSET) is selected, this value can be queried only.

- Parameters:**
- 0** No effect. The output bit sequence is v0,v1,v2,v3.
  - 1** Interchange of MSBs with LSBs. The output bit sequence is v2,v3,v0,v1.
  - 2** Inversion of LSBs. The output bit sequence is v0,v1,NOTv2,NOTv3.
  - 3** Interchange of MSBs with LSBs and inversion of LSBs. The output bit sequence is v2,v3,NOTv0,NOTv1.

**Example:** "BB:W3GP:BST2:CHAN12:HSDP:CVPB 1"  
'selects interchange of MSBs with LSBs.

*RST value	Resolution	Options	SCPI
0	-	B10/B11 and B13 K42 SOURce2 only with second option B9/B10/B11	Device-specific

[SOURce<[1]|2>:]BB:W3GPP:BSTation1:CHANnel12:HSDPa:HARQ:LENGth?

The command queries the number of HARQ processes. This value determines the distribution of the payload in the subframes.

This command is query only and therefore has no \*RST value.

**Example:** "BB:W3GP:BST1:CHAN12:HSDP:MODE HSET"  
'selects H-Set mode.  
  
"BB:W3GP:BST1:CHAN12:HSDP:HARQ:CLEN?"  
'queries the number of HARQ processes.  
  
Response: "2"

*RST value	Resolution	Options	SCPI
-	-	B10/B11 and B13 K42 SOURce2 only with second option B9/B10/B11	Device-specific

[SOURce<[1]|2>:]BB:W3GPP:BSTation1:CHANnel12:HSDPa:HSET 1 ... 5

The command selects the H-Set according to TS 25.1401 Annex A.7.

**Example:** "BB:W3GP:BST1:CHAN12:HSDP:MODE HSET"  
'selects H-Set mode.  
  
"BB:W3GP:BST1:CHAN12:HSDP:HSET 2"  
'selects H-Set 2.

*RST value	Resolution	Options	SCPI
1	-	B10/B11 and B13 K42 SOURce2 only with second option B9/B10/B11	Device-specific



**[SOURce<[1]>:]BB:W3GPp:BSTation:CHANnel:HSDPa:HSET:PRESet**

The command calls the default settings of the channel table for the HSDPA H-Set mode. Channels 12 to 17 are preset for HSDPA H-Set 1.

This command triggers an event and therefore has no \*RST value and no query form.

**Example:** "BB:W3GP:BST:CHAN:HSDP:HSET:PRES"  
'sets channels 12 to 17 for HSDPA H-Set 1.

*RST value	Resolution	Options	SCPI
	-	B10/B11 and B13 K42 SOURce2 only with second option B9/B10/B11	Device-specific

**[SOURce<[1]>:]BB:W3GPp:BSTation<[1]>|2|3|4>:CHANnel<9...138>:HSDPa:MODE CONTInuous | PSF0 | PSF1 | PSF2 | PSF3 | PSF4 | HSET**

The command selects the HSDPA mode.

**Parameters:**     **CONTInuous**   The high speed channel is generated continuously. This mode is defined in test model 5.

**PSFx**            The high speed channel is generated in packet mode. The start of the channel is set by selecting the subframe in which the first packet is sent.

**HSET**            The high speed channels are preset according to TS 25.1401 Annex A.7, H-Set.

**Example:**           "BB:W3GP:BST2:CHAN12:HSDP:MODE PSF1"  
'selects packet mode for channel 12. The first packet is sent in packet subframe 1 (PSF1).

*RST value	Resolution	Options	SCPI
CONT	-	B10/B11 and B13 K42 SOURce2 only with second option B9/B10/B11	Device-specific

**[SOURce<[1]>:]BB:W3GPp:BSTation1:CHANnel12:HSDPa:NAIB?**

The command queries the average data rate on the transport layer (Nominal Average Information Bitrate)

This command is query only and therefore has no \*RST value.

**Example:**           "BB:W3GP:BST1:CHAN12:HSDP:MODE HSET"  
'selects H-Set mode.

                  "BB:W3GP:BST1:CHAN12:HSDP:NAIB?"  
'queries the average data rate on the transport layer.

Response: "455"

*RST value	Resolution	Options	SCPI
-	-	B10/B11 and B13 K42 SOURce2 only with second option B9/B10/B11	Device-specific

**[SOURce<[1]>:]BB:W3GPP:BSTation1:CHANnel12:HSDPa:PRSR?**

The command queries the rate matching mode (depending on the selected Redundancy Version Parameter).

This command is query only and therefore has no \*RST value.

**Example:** "BB:W3GP:BST1:CHAN12:HSDP:MODE HSET"  
'selects H-Set mode.

"BB:W3GP:BST1:CHAN12:HSDP:PRSR?"  
'queries the rate matching mode.

Response: "0"

*RST value	Resolution	Options	SCPI
-	-	B10/B11 and B13 K42 SOURce2 only with second option B9/B10/B11	Device-specific

**[SOURce<[1]>:]BB:W3GPP:BSTation1:CHANnel12:HSDPa:PSBS?**

The command queries the processing mode of the data bits (depending on the selected Redundancy Version Parameter).

This command is query only and therefore has no \*RST value.

**Example:** "BB:W3GP:BST1:CHAN12:HSDP:MODE HSET"  
'selects H-Set mode.

"BB:W3GP:BST1:CHAN12:HSDP:PSBS?"  
'queries the processing mode of the data bits.

Response: "1"

*RST value	Resolution	Options	SCPI
-	-	B10/B11 and B13 K42 SOURce2 only with second option B9/B10/B11	Device-specific

**[SOURce<[1]>:]BB:W3GPp:BSTation1:CHANnel12:HSDPa:RVParameter 0 ... 7**

The command sets the Redundancy Version Parameter. This value determines the processing of the Forward Error Correction and Constellation Arrangement (QAM16 modulation), see TS 25.212 4.6.2.

**Example:** "BB:W3GP:BST1:CHAN12:HSDP:MODE HSET"  
'selects H-Set mode.

"BB:W3GP:BST1:CHAN12:HSDP:RVP 2"  
'selects Redundancy Version Parameter 2.

*RST value	Resolution	Options	SCPI
0	-	B10/B11 and B13 K42 SOURce2 only with second option B9/B10/B11	Device-specific

**[SOURce<[1]>:]BB:W3GPp:BSTation1:CHANnel12:HSDPa:SFORmat 0 | 1**

The command sets the slot format for HS-PDSCH. Slot format 1 corresponds to QPSK and slot format 2 to 16QAM. The number of preset channels depends on the select slot format: Five channels are preset with selection 0 (QPSK) and four channels are preset with selection 1 (16QAM).

**Example:** "BB:W3GP:BST1:CHAN12:HSDP:MODE HSET"  
'selects H-Set mode.

"BB:W3GP:BST1:CHAN12:HSDP:SFOR 1"  
'selects slot format 1 (16QAM) with four channels being preset.

*RST value	Resolution	Options	SCPI
0	-	B10/B11 and B13 K42 SOURce2 only with second option B9/B10/B11	Device-specific

**[SOURce<[1]>:]BB:W3GPp:BSTation<[1]>|2|3|4>:CHANnel<9...138>:HSDPa:TTIDistance 1 ... 16**

The command selects the distance between two packets in HSDPA packet mode. The distance is set in number of sub-frames (3 slots = 2 ms). An **Inter TTI Distance** of 1 means continuous generation.

**Example:** "BB:W3GP:BST2:CHAN12:HSDP:TTID 2"  
'selects an Inter TTI Distance of 2 subframes.

*RST value	Resolution	Options	SCPI
5	-	B10/B11 and B13 K42 SOURce2 only with second option B9/B10/B11	Device-specific

[SOURce<[1]|2>:]BB:W3GPP:BSTation<[1]|2|3|4>:CHANnel<9...138>:HSUPa:EHICH:CTYPe  
SERVing | NOSERVing

The command selects the cell type.

**Example:** "SOUR:BB:W3GP:BST1:CHAN9:HSUP:ERGC:CTYP SERV"  
'selects the serving cell type.

*RST value	Resolution	Options	SCPI
SERVing	-	B10/B11 and B13 K42 SOURce2 only with second option B9/B10/B11	Device-specific

[SOURce<[1]|2>:]BB:W3GPP:BSTation<[1]|2|3|4>:CHANnel<9...138>:HSUPa:EHICH:DTAU 0 ...  
149

The command sets the offset of the downlink dedicated offset channels.

**Example:** "SOUR:BB:W3GP:BST1:CHAN12:HSUP:EHIC:DTAU 5"  
'selects the offset of the downlink dedicated offset channels.

*RST value	Resolution	Options	SCPI
0	-	B10/B11 and B13 K42 SOURce2 only with second option B9/B10/B11	Device-specific

[SOURce<[1]|2>:]BB:W3GPP:BSTation<[1]|2|3|4>:CHANnel<9...138>:HSUPa:EHICH:ETAU ?

The command queries the offset of the P-CCPCH frame boundary.

The command is a query and therefore does not have an \*RST value.

**Example:** "SOUR:BB:W3GP:BST1:CHAN12:HSUP:EHIC:ETAU?"  
'queries the offset of the P-CCPCH frame boundary.

*RST value	Resolution	Options	SCPI
-	-	B10/B11 and B13 K42 SOURce2 only with second option B9/B10/B11	Device-specific

[SOURce<[1]|2>:]BB:W3GPp:BSTation<[1]|2|3|4>:CHANnel<9...138>:HSUPa:EHIC:RGPAttern <bit pattern>

The command sets the bit pattern for the ACK/NACK field.

**Example:** "SOUR:BB:W3GP:BST1:CHAN10:HSUP:EHIC:RGPA "+"  
 'sets the bit pattern to "+" (ACK).

*RST value	Resolution	Options	SCPI
+	-	B10/B11 and B13 K42 SOURce2 only with second option B9/B10/B11	Device-specific

[SOURce<[1]|2>:]BB:W3GPp:BSTation<[1]|2|3|4>:CHANnel<9...138>:HSUPa:EHIC:SSINdex 0...39>

The command sets the value that identifies the user equipment. The values are defined in TS 25.211.

**Example:** "SOUR:BB:W3GP:BST1:CHAN9:HSUP:EHIC:SSIN 0"  
 'sets the value to identify the user equipment.

*RST value	Resolution	Options	SCPI
0	-	B10/B11 and B13 K42 SOURce2 only with second option B9/B10/B11	Device-specific

[SOURce<[1]|2>:]BB:W3GPp:BSTation<[1]|2|3|4>:CHANnel<9...138>:HSUPa:EHIC:TTIEdch 2ms | 10ms>

The command sets processing duration.

**Example:** "SOUR:BB:W3GP:BST1:CHAN10:HSUP:EHIC:TTIE 2ms"  
 'sets the processing duration to 2 ms.

*RST value	Resolution	Options	SCPI
2ms	-	B10/B11 and B13 K42 SOURce2 only with second option B9/B10/B11	Device-specific

[SOURce<[1]|2>:]BB:W3GPP:BSTation<[1]|2|3|4>:CHANnel<9...138>:HSUPa:ERGCh:CTYPe  
SERVing | NOSERVing

The command selects the cell type.

**Example:** "SOUR:BB:W3GP:BST1:CHAN9:HSUP:ERGC:CTYP SERV"  
'selects the serving cell type.

*RST value	Resolution	Options	SCPI
SERVing	-	B10/B11 and B13 K42 SOURce2 only with second option B9/B10/B11	Device-specific

[SOURce<[1]|2>:]BB:W3GPP:BSTation<[1]|2|3|4>:CHANnel<9...138>:HSUPa:ERGCh:DTAU 0 ...  
149

The command sets the offset of the downlink dedicated offset channels.

**Example:** "SOUR:BB:W3GP:BST1:CHAN12:HSUP:ERGC:DTAU 5"  
'sets the offset of the downlink dedicated offset channels.

*RST value	Resolution	Options	SCPI
0	-	B10/B11 and B13 K42 SOURce2 only with second option B9/B10/B11	Device-specific

[SOURce<[1]|2>:]BB:W3GPP:BSTation<[1]|2|3|4>:CHANnel<9...138>:HSUPa:ERGCh:ETAU ?

The command queries the offset of the P-CCPCH frame boundary.

The command is a query and therefore does not have an \*RST value.

**Example:** "SOUR:BB:W3GP:BST1:CHAN12:HSUP:ERGC:ETAU?"  
'queries the offset of the P-CCPCH frame boundary.

*RST value	Resolution	Options	SCPI
-	-	B10/B11 and B13 K42 SOURce2 only with second option B9/B10/B11	Device-specific

[SOURce<[1]|2>:]BB:W3GPp:BSTation<[1]|2|3|4>:CHANnel<9...138>:HSUPa:ERGCh:RGPattern <bit pattern>

The command sets the bit pattern for the Relative Grant Pattern field.

**Example:** "SOUR:BB:W3GP:BST1:CHAN10:HSUP:ERGC:RGPA "-""  
'sets the bit pattern to "-" (Down).

*RST value	Resolution	Options	SCPI
-	-	B10/B11 and B13 K42 SOURce2 only with second option B9/B10/B11	Device-specific

[SOURce<[1]|2>:]BB:W3GPp:BSTation<[1]|2|3|4>:CHANnel<9...138>:HSUPa:ERGCh:SSIndex 0...39>

The command sets the value that identifies the user equipment. The values are defined in TS 25.211.

**Example:** "SOUR:BB:W3GP:BST1:CHAN9:HSUP:ERGC:SSIN 0"  
'sets the value to identify the user equipment.

*RST value	Resolution	Options	SCPI
0	-	B10/B11 and B13 K42 SOURce2 only with second option B9/B10/B11	Device-specific

[SOURce<[1]|2>:]BB:W3GPp:BSTation<[1]|2|3|4>:CHANnel<9...138>:HSUPa:ERGCh:TTIEdch 2ms | 10ms>

The command sets processing duration.

**Example:** "SOUR:BB:W3GP:BST1:CHAN10:HSUP:ERGC:TTIE 2ms"  
'sets the processing duration to 2 ms.

*RST value	Resolution	Options	SCPI
2ms	-	B10/B11 and B13 K42 SOURce2 only with second option B9/B10/B11	Device-specific

[SOURce<[1]|2>:]BB:W3GPP:BSTation1:CHANnel12:HSDPa:UEID 0 ... 65535

The command sets the UE identity which is the HS-DSCH Radio Network Identifier (H-RNTI) defined in 3GPP TS 25.331: "Radio Resource Control (RRC); Protocol Specification".

**Example:** "BB:W3GP:BST1:CHAN12:HSDP:MODE HSET"  
 'selects H-Set mode.  
 "BB:W3GP:BST1:CHAN12:HSDP:UEID 256"  
 'sets the UE identity .

*RST value	Resolution	Options	SCPI
0	-	B10/B11 and B13 K42 SOURce2 only with second option B9/B10/B11	Device-specific

[SOURce<[1]|2>:]BB:W3GPP:BSTation<[1]|2|3|4>:CHANnel<0|[1]...138>:POWer -80 dB... 0 dB

The command sets the channel power relative to the powers of the other channels. This setting also determines the starting power of the channel for Misuse TPC and Dynamic Power Control.

With the command SOURce:BB:W3GPP:POWer:ADJusT, the power of all the activated channels is adapted so that the total power corresponds to 0 dB. This will not change the power ratio among the individual channels.

**Example:** "BB:W3GP:BST2:CHAN12:POW -10dB"  
 'sets the channel power of channel 12 of base station 2 to -10 dB relative to the power of the other channels.

*RST value	Resolution	Options	SCPI
0 dB	0.01 dB	B10/B11 and B13 K42 SOURce2 only with second option B9/B10/B11	Device-specific

[SOURce<[1]|2>:]BB:W3GPP:BSTation:CHANnel:PRESet

The command calls the default settings of the channel table.

This command triggers an event and therefore has no \*RST value and no query form.

**Example:** "BB:W3GP:BST:CHAN:PREs"  
 'presets all channels of the base station.

*RST value	Resolution	Options	SCPI
	-	B10/B11 and B13 K42 SOURce2 only with second option B9/B10/B11	Device-specific



**[SOURce<[1]|2>:]BB:W3GPp:BSTation<[1]|2|3|4>:CHANnel<5|9...138>:SFORmat <num\_value>**

The command sets the slot format of the selected channel. The value range depends on the selected channel.

**Example:** "BB:W3GP:BST2:CHAN12:SFOR 8"  
'selects slot format 8 for channel 12 of base station 2.

*RST value	Res.	Options	Dependency	SCPI
DPCH 8 S-CCPCH (CHAN6) 0 PDSCH (CHAN10) 0 DL-DPCCH (CHAN11) 0	-	B10/B11 and B13 K42 SOURce2 only with second option B9/B10/B11	The slot format determines the symbol rate (and thus the range of values for the channelization code), the TFCI state and the pilot length. If the value of any one of the four parameters is changed, all the other parameters will be adapted as necessary.  In the case of enhanced channels with active channel coding, the selected channel coding also affects the slot format and thus the remaining parameters. If these parameters are changed, the channel coding type is set to user.	Device-specific

**[SOURce<[1]|2>:]BB:W3GPp:BSTation<[1]|2|3|4>:CHANnel<0|[1]...138>:SRATe D7K5 | D15K | D30K | D60K | D120K | D240K | D480K | D960K**

The command sets the symbol rate of the selected channel. The value range depends on the selected channel and the selected slot format.

**Example:** "BB:W3GP:BST2:CHAN12:SRAT D120K"  
'sets the symbol rate for channel 12 of base station 2 to 120 ksp.

*RST value	Res.	Options	Dependency	SCPI
DPCHs D30K CHAN1..10 D15K DL-DPCCH (CHAN11) D7K5	-	B10/B11 and B13 K42 SOURce2 only with second option B9/B10/B11	The slot format determines the symbol rate (and thus the range of values for the channelization code), the TFCI state and the pilot length. If the value of any one of the four parameters is changed, all the other parameters will be adapted as necessary.  In the case of enhanced channels with active channel coding, the selected channel coding also affects the slot format and thus the remaining parameters. If these parameters are changed, the channel coding type is set to user.	Device-specific

**[SOURce<[1]|2>:]BB:W3GPp:BSTation<[1]|2|3|4>:CHANnel<0|[1]...138>:STATe ON | OFF**

The command activates the selected channel.

**Example:** "BB:W3GP:BST2:CHAN12:STAT OFF"  
'deactivates channel 12 of base station 2.

*RST value	Resolution	Options	SCPI
OFF	-	B10/B11 and B13 K42 SOURce2 only with second option B9/B10/B11	Device-specific

**[SOURce<[1]|2>:]BB:W3GPP:BSTation<[1]|2|3|4>:CHANnel<5|6|11...138>:TOFFset 0 ... 149**

The command sets the timing offset . The timing offset defines the number of chips by which the absolute starting time of the frames (slot 0) is shifted relative to the start of the scrambling code sequence:  $T_{\text{Offset}} * 256$  Chips. This procedure is used to reduce the crest factor.

**Note:**

For F-DPCH channels, the value range is 0 to 9.

**Example:**

"BB:W3GP:BST2:CHAN12:TOFF 20"

'defines a frame shift relative to the scrambling code sequence of 20\*256 chips.

*RST value	Resolution	Options	SCPI
0	-	B10/B11 and B13 K42 SOURce2 only with second option B9/B10/B11	Device-specific

**[SOURce<[1]|2>:]BB:W3GPP:BSTation<[1]|2|3|4>:CHANnel<0|[1]...138>:TYPE**

DPCH | PCPich | SCPich | PSCH | SSCH | PCCPch| SCCPch| PICH | APAich | AICH | PDSCch | DPCCh | HSSCch | HSQPsk | HSQam | EAGCh | ERGCh | EHICH | FDPCh

The command selects the channel type.

The channel type is fixed for channel numbers 0 ... 8, for the remaining channel numbers, the choice lies between the relevant standard channels and the high-speed channels.

**Example:**

"BB:W3GP:BST2:CHAN12:TYPE HSQP"

'selects channel type HS-PDS, QPSK for channel 12 of the channel table.

*RST value	Resolution	Options	SCPI
-	-	B10/B11 and B13 K42 SOURce2 only with second option B9/B10/B11	Device-specific

[SOURce<[1]|2>:]BB:W3GPP:BSTation<2|3|4>:CMODE:DLFStructure A | B

The command selects the frame structure. The frame structure determines the transmission of TPC and pilot field in the transmission gaps.

Compressed Mode can be configured for base stations 2, 3 and 4.

- Parameters:**
- A**  
Type A, the pilot field is sent in the last slot of each transmission gap.
  - B**  
Type B, the pilot field is sent in the last slot of each transmission gap. The first TPC field of the transmission gap is sent in addition.

**Example:** "BB:W3GP:BST2:CMOD:DLFS A"  
'selects frame structure of type A.

*RST value	Resolution	Options	SCPI
A	-	B10/B11 and B13 K42 SOURce2 only with second option B9/B10/B11	Device-specific

[SOURce<[1]|2>:]BB:W3GPP:BSTation<2|3|4>:CMODE:METHod HLSCheduling| PUNCTuring| SF2

The command selects compressed mode method..

Compressed Mode can be configured for base stations 2, 3 and 4.

- Parameters:**
- PUNCTuring**  
The data is compressed by reducing error protection.
  - HLSCheduling**  
The data is compressed by stopping the transmission of the data stream during the transmission gap.
  - SF2**  
The data is compressed by halving the spreading factor.

**Example:** "BB:W3GP:BST2:CMOD:METH HLSC"  
'selects compressed mode method High Layer Scheduling.

*RST value	Resolution	Options	SCPI
PUNCTuring	-	B10/B11 and B13 K42 SOURce2 only with second option B9/B10/B11	Device-specific

[SOURce<[1]>:]BB:W3Gp:BSTation<2|3|4>:CMODE:PATtern<[1]>:TGD 3...100 slots

The command sets the transmission gap distances.

Compressed Mode can be configured for base stations 2, 3 and 4.

**Example:** "BB:W3GP:BST2:CMOD:PATT2:TGD 7"  
 'sets transmission gap distance of pattern 2 to 7 slots.

*RST value	Resolution	Options	Dependencies	SCPI
15 slots	-	B10/B11 and B13 K42 SOURce2 only with second option B9/B10/B11	The transmission gap distances of the user equipment with the same suffix as the selected base station is set to the same value.	Device-specific

[SOURce<[1]>:]BB:W3Gp:BSTation<2|3|4>:CMODE:PATtern<[1]>:TGL<[1]> 3...14 slots

The command sets the transmission gap lengths.

Compressed Mode can be configured for base stations 2, 3 and 4.

**Example:** "BB:W3GP:BST2:CMOD:PATT2:TGL1 4"  
 'sets transmission gap length of gap 1 of pattern 2 to 4 slots.

*RST value	Resolution	Options	Dependencies	SCPI
3 slots	-	B10/B11 and B13 K42 SOURce2 only with second option B9/B10/B11	The transmission gap lengths of the user equipment with the same suffix as the selected base station are set to the same value.	Device-specific

[SOURce<[1]>:]BB:W3Gp:BSTation<2|3|4>:CMODE:PATtern<[1]>:TGPL 1/0...100 frames

The command sets the transmission gap pattern lengths. Setting 0 is available only for pattern 2.

Compressed Mode can be configured for base stations 2, 3 and 4.

**Example:** "BB:W3GP:BST2:CMOD:PATT2:TGPL 7"  
 'sets transmission gap pattern length of pattern 2 to 7 frames.

*RST value	Resolution	Options	Dependencies	SCPI
2 frames	-	B10/B11 and B13 K42 SOURce2 only with second option B9/B10/B11	The transmission gap pattern length of the user equipment with the same suffix as the selected base station is set to the same value.	Device-specific

[SOURce<[1]|2>:]BB:W3GPp:BSTation<2|3|4>:CMODE:PATtern<[1]|2>:TGSN slot 0...slot 14

The command sets the transmission gap slot number of pattern 1. Slot number of pattern 2 is automatically set to the same value as slot number of pattern 1.

Compressed Mode can be configured for base stations 2, 3 and 4.

**Example:** "BB:W3GP:BST2:CMOD:PATT:TGSN 4  
'sets slot number of pattern 1 to slot 4.

*RST value	Resolution	Options	Dependencies	SCPI
Slot 7	-	B10/B11 and B13 K42 SOURce2 only with second option B9/B10/B11	The slot numbers of the user equipment with the same suffix as the selected base station are set to the same value.	Device-specific

[SOURce<[1]|2>:]BB:W3GPp:BSTation<2|3|4>:CMODE:POMode AUTO | USER

The command selects the power offset mode..

Compressed Mode can be configured for base stations 2, 3 and 4.

**Parameters: AUTO**  
The power offset is obtained by pilot bit ratio as follows:  
Number of pilots bits of non-compressed slots/Number of pilot bits by compressed slots.

**USER**  
The power offset is defined by command  
:BB:W3GP:BSTation<2|3|4>CMODE:POFFset

**Example:** "BB:W3GP:BST2:CMOD:POFF 4"  
'sets the power offset value to 4 dB.  
"BB:W3GP:BST2:CMOD:POM USER"  
'selects power offset mode USER, the power offset is set to 4 dB.

*RST value	Resolution	Options	SCPI
AUTO	-	B10/B11 and B13 K42 SOURce2 only with second option B9/B10/B11	Device-specific

[SOURce<[1]|2>:]BB:W3GPp:BSTation<2|3|4>:CMODE:POFFset 0 dB...10 dB

The command sets the power offset for mode USER..

Compressed Mode can be configured for base stations 2, 3 and 4.

**Example:** "BB:W3GP:BST2:CMOD:POFF 4"  
'sets the power offset value to 4 dB.

"BB:W3GP:BST2:CMOD:POM USER"  
'selects power offset mode USER, the power offset is set to 4 dB.

*RST value	Resolution	Options	SCPI
0 dB	0.01 dB	B10/B11 and B13 K42 SOURce2 only with second option B9/B10/B11	Device-specific

[SOURce<[1]|2>:]BB:W3GPp:BSTation<2|3|4>:CMODE:STATe ON | OFF

The command activates/deactivates the compressed mode.

Compressed Mode can be activated for base stations 2, 3 and 4.

**Example:** "BB:W3GP:BST2:CMOD:STAT ON"  
'activates compressed mode for base station 2.

*RST value	Resolution	Options	SCPI
OFF	-	B10/B11 and B13 K42 SOURce2 only with second option B9/B10/B11	Device-specific

[SOURce<[1]|2>:]BB:W3GPp:BSTation<[1]|2|3|4>:DCONflict:RESolve

The command resolves existing domain conflicts by modifying the Channelization Codes of the affected channels.

The command is an event and therefore does not have an \*RST value and a query form.

**Example:** "BB:W3GP:BST2:DCON:STAT?"  
'queries whether a code domain conflict exists for base station 2.

'Response: "1"  
'there is a conflict.

"BB:W3GP:BST2:DCON:RES"  
'resolves the code domain error by modifying the Channelization codes of the affected channels.

*RST value	Resolution	Options	SCPI
-	-	B10/B11 and B13 K42 SOURce2 only with second option B9/B10/B11	Device-specific

**[SOURce<[1]|2>:]BB:W3GPP:BSTation<[1]|2|3|4>:DConflict[:STATe]?**

The command queries whether there is (response 1) or is not (response 0) a conflict (overlap) in the hierarchically-structured channelization codes. The cause of a possible domain conflict can be ascertained by manual operation in the **Code Domain** submenu (main menu 3GPP FDD).

The command is a query and therefore does not have an \*RST value.

**Example:**           "BB:W3GP:BST2:DCON:STAT?"  
                  'queries whether a code domain conflict exists for base station 2.  
  
"Response: "0"  
                  'there is no conflict.

*RST value	Resolution	Options	SCPI
-	-	B10/B11 and B13 K42 SOURce2 only with second option B9/B10/B11	Device-specific

**[SOURce<[1]|2>:]BB:W3GPP:BSTation:OCNS:STATe ON | OFF**

The command activates OCNS channels, as defined in the standard.

Two different OCNS scenarios are defined in the standard; one standard scenario and one scenario for testing HSDPA channels. The required scenario can be selected with the command  
:BB:W3GP:BST:OCNS:MODE.

**Example:**           "BB:W3GP:BST:OCNS:MODE STAN"  
                  'selects the standard scenario.  
  
"BB:W3GP:BST:OCNS:STAT ON"  
                  'activates the OCNS channels with the settings defined in the standard.

*RST value	Resolution	Options	SCPI
OFF	-	B10/B11 and B13 K42 SOURce2 only with second option B9/B10/B11	Device-specific

**[SOURce<[1]|2>:]BB:W3GPP:BSTation:OCNS:MODE STANdard | HSDPa**

The command selects the scenario for setting the OCNS channels.

Two different OCNS scenarios are defined in the standard; one standard scenario and one scenario for testing HSDPA channels.

**Example:**           "BB:W3GP:BST:OCNS:MODE HSDP"  
                  'selects the scenario for testing the high-speed channels.  
  
"BB:W3GP:BST:OCNS:STAT ON"  
                  'activates the OCNS channels with the settings defined in the standard.

*RST value	Resolution	Options	SCPI
STANdard	-	B10/B11 and B13 K42 SOURce2 only with second option B9/B10/B11	Device-specific

[SOURce<[1]|2>:]BB:W3GpP:BSTation<[1]|2|3|4>:PINDicator:COUNT D18 | D36 | D72 | D144

The command sets the number of page indicators (PI) per frame in the page indicator channel (PICH).

**Example:** "BB:W3GP:BST2:PIND:COUN D36"  
 'sets the number of page indicators (PI) per frame in the page indicator channel (PICH) to 36.

*RST value	Resolution	Options	SCPI
D18	-	B10/B11 and B13 K42 SOURce2 only with second option B9/B10/B11	Device-specific

[SOURce<[1]|2>:]BB:W3GpP:BSTation:PRESet

The command produces a standardized default for all the base stations. The settings correspond to the \*RST values specified for the commands.

This command triggers an action and therefore has no \*RST value and no query form.

**Example:** "BB:W3GP:BST:PRES"  
 'resets all the base station settings to default values.

*RST value	Resolution	Options	Dependencies	SCPI
-	-	B10/B11 and B13 K42 SOURce2 only with second option B9/B10/B11	All base station settings are preset. An overview is provided by Table in Chapter 4.	Device-specific

[SOURce<[1]|2>:]BB:W3GpP:BSTation<[1]|2|3|4>:SCODE #H0...#H5FFF

The command sets the identification for the base station. This value is simultaneously the initial value of the scrambling code generator.

**Example:** "BB:W3GP:BST2:SCOD #H5FFF"  
 'sets scrambling code #HFFF.

*RST value	Resolution	Options	SCPI
#H0	-	B10/B11 and B13 K42 SOURce2 only with second option B9/B10/B11	Device-specific



**[SOURce<[1]|2>:]BB:W3GPP:BSTation<[1]|2|3|4>:SCODE:STATe ON | OFF**

The command makes it possible to deactivate base station scrambling for test purposes.

**Example:** "BB:W3GP:BST2:SCOD:STAT OFF"  
'deactivates scrambling for base station 2.'

*RST value	Resolution	Options	SCPI
ON	-	B10/B11 and B13 K42 SOURce2 only with second option B9/B10/B11	Device-specific

**[SOURce<[1]|2>:]BB:W3GPP:BSTation<[1]|2|3|4>:SCPich:PREFere[nce]:STATe] ON | OFF**

The command activates or deactivates the use of S-CPICH as reference phase.

**Example:** "BB:W3GP:BST2:SCP:REF ON"  
'activates the use of S-CPICH as reference phase for base station 2.'

*RST value	Resolution	Options	SCPI
OFF	-	B10/B11 and B13 K42 SOURce2 only with second option B9/B10/B11	Device-specific

**[SOURce<[1]|2>:]BB:W3GPP:BSTation<[1]|2|3|4>:SSCG?**

The command queries the secondary synchronization code group. This parameter is specified in the table defined by the 3GPP standard "Allocation of SSCs for secondary SCH". This table assigns a specific spreading code to the synchronization code symbol for every slot in the frame. The value is calculated from the scrambling code.

The command is a query command and therefore does not have an \*RST value.

**Example:** "BB:W3GP:BST2:SSCG?"  
'queries the 2nd search code group for base station 2.'

Response: "24"  
'the base station is part of second search group 24.'

*RST value	Resolution	Options	SCPI
-	-	B10/B11 and B13 K42 SOURce2 only with second option B9/B10/B11	Device-specific

[SOURce<[1]|2>:]BB:W3GPP:BSTation<[1]|2|3|4>:STATe ON | OFF

The command activates and deactivates the specified base station.

**Example:** "BB:W3GP:BST2:STAT OFF"  
'deactivates base station 2.

*RST value	Resolution	Options	SCPI
OFF	-	B10/B11 and B13 K42 SOURce2 only with second option B9/B10/B11	Device-specific

[SOURce<[1]|2>:]BB:W3GPP:BSTation<2|3|4>:TDELay 0 ... 38400 chips

The command sets the time shift of the selected base station compared to base station 1 in chips.

The command is only valid for base stations 2, 3 and 4. So a suffix must be specified at BSTation (2, 3, or 4).

**Example:** "BB:W3GP:BST2:TDEL 256"  
'shifts base station 2 by 256 chips compared to base station 1.

*RST value	Resolution	Options	SCPI
0		B10/B11 and B13 K42 SOURce2 only with second option B9/B10/B11	Device-specific

[SOURce<[1]|2>:]BB:W3GPP:BSTation<[1]|2|3|4>:TDiversity OFF| ANT1 | ANT2

The command activates and deactivates signal calculation with transmit diversity (OFF). To activate transmit diversity, you must specify the antenna whose signals are to be simulated (ANT1 or ANT2):

**Parameters:** **OFF**  
No transmit diversity.

**ANT1**  
Calculate and apply the output signal for antenna 1.

**ANT2**  
Calculate and apply the output signal for antenna 2.

**Example:** "BB:W3GP:BST2:TDIV ANT2"  
'activates transmit diversity, the signal of antenna 2 is simulated.

*RST value	Resolution	Options	SCPI
OFF	-	B10/B11 and B13 K42 SOURce2 only with second option B9/B10/B11	Device-specific

## SOURCE:W3GPP - Enhanced Channels of Base Station 1

The SOURCE:BB:W3GPP:BSTation:ENHanced subsystem contains the commands for setting the enhanced channels of base station 1. The commands of this system only take effect when the 3GPP FDD standard is activated, the uplink transmission direction is selected, base station 1 is enabled and enhanced channels are activated:

SOURCE:BB:W3GPP:STATE ON

SOURCE:BB:W3GPP:LINK UP

SOURCE:BB:W3GPP:BST1:STATE ON

SOURCE:BB:W3GPP:BST:ENHanced:CHANnel<11...13>:DPCH:STATE ON

or

SOURCE:BB:W3GPP:BST:ENHanced:PCCPch:STATE ON

Command	Parameters	Default unit	Comments
[SOURCE<[1]>:]BB:W3GPP:BSTation:ENHanced:CHANnel<11...13>:DPCH:CCODing:BPFRame?			Query only
[SOURCE<[1]>:]BB:W3GPP:BSTation:ENHanced:CHANnel<11...13>:DPCH:CCODing:SFORmat	0...16		
[SOURCE<[1]>:]BB:W3GPP:BSTation:ENHanced:CHANnel<11...13>:DPCH:CCODing:SRATE?			Query only
[SOURCE<[1]>:]BB:W3GPP:BSTation:ENHanced:CHANnel<11...13>:DPCH:CCODing:STATE	ON   OFF		
[SOURCE<[1]>:]BB:W3GPP:BSTation:ENHanced:CHANnel<11...13>:DPCH:CCODing:TYPE	M12K2   M64K   M144k   M384k   AMR   BTfD1   BTfD2   BTfD3		
[SOURCE<[1]>:]BB:W3GPP:BSTation:ENHanced:CHANnel<11...13>:DPCH:CCODing:USER:CATalog?			Query only
[SOURCE<[1]>:]BB:W3GPP:BSTation:ENHanced:CHANnel:DPCH:CCODing:USER:DELETE	<u_coding >		No query
[SOURCE<[1]>:]BB:W3GPP:BSTation:ENHanced:CHANnel<11...13>:DPCH:CCODing:USER:LOAD	<u_coding >		No query
[SOURCE<[1]>:]BB:W3GPP:BSTation:ENHanced:CHANnel<11...13>:DPCH:CCODing:USER:STORE	<u_coding >		No query
[SOURCE<[1]>:]BB:W3GPP:BSTation:ENHanced:CHANnel<11...13>:DPCH:DERRor:BIT:LAYer	TRANsport   PHYSical		
[SOURCE<[1]>:]BB:W3GPP:BSTation:ENHanced:CHANnel<11...13>:DPCH:DERRor:BIT:RATE	1E-7...5E-1		
[SOURCE<[1]>:]BB:W3GPP:BSTation:ENHanced:CHANnel<11...13>:DPCH:DERRor:BIT:STATE	ON   OFF		
[SOURCE<[1]>:]BB:W3GPP:BSTation:ENHanced:CHANnel<11...13>:DPCH:DERRor:BLOCK:RATE	1E-4...5E-1		
[SOURCE<[1]>:]BB:W3GPP:BSTation:ENHanced:CHANnel<11...13>:DPCH:DERRor:BLOCK:STATE	ON   OFF		
[SOURCE<[1]>:]BB:W3GPP:BSTation:ENHanced:CHANnel<11...13>:DPCH:DPControl:DIRection	UP   DOWN		
[SOURCE<[1]>:]BB:W3GPP:BSTation:ENHanced:CHANnel<11...13>:DPCH:DPControl:MODE	EXTernal   TPC   MANual		

Command	Parameters	Default unit	Comments
[SOURce<[1]]2>:BB:W3GPP:BSTation:ENHanced:CHANnel<11...13>:DPCH:DPControl[:POWER]			Query only
[SOURce<[1]]2>:BB:W3GPP:BSTation:ENHanced:CHANnel<11...13>:DPCH:DPControl:RANGe:DOWN	0.0 ...30.0dB		
[SOURce<[1]]2>:BB:W3GPP:BSTation:ENHanced:CHANnel<11...13>:DPCH:DPControl:RANGe:UP	0.0 ...30.0dB		
[SOURce<[1]]2>:BB:W3GPP:BSTation:ENHanced:CHANnel<11...13>:DPCH:DPControl:STATE	ON   OFF		
[SOURce<[1]]2>:BB:W3GPP:BSTation:ENHanced:CHANnel<11...13>:DPCH:DPControl:STEP[:EXTernal]	0.5... 6.0dB		
[SOURce<[1]]2>:BB:W3GPP:BSTation:ENHanced:CHANnel<11...13>:DPCH:DPControl:STEP:MANual	MAN0   MAN1		No query
[SOURce<[1]]2>:BB:W3GPP:BSTation:ENHanced:CHANnel<11...13>:DPCH:INTerleaver 2	ON   OFF		
[SOURce<[1]]2>:BB:W3GPP:BSTation:ENHanced:CHANnel<11...13>:DPCH:STATE	ON   OFF		
[SOURce<[1]]2>:BB:W3GPP:BSTation:ENHanced:CHANnel<11...13>:DPCH:TCHannel<0[[1]...6>:CRCSize	NONE   8  12  16   24		
[SOURce<[1]]2>:BB:W3GPP:BSTation:ENHanced:CHANnel<11...13>:DPCH:TCHannel<0[[1]...6>:DATA	PN9   PN15   PN16   PN20  PN21   PN23   DLISt   ZERO   ONE   PATTern		
[SOURce<[1]]2>:BB:W3GPP:BSTation:ENHanced:CHANnel<11...13>:DPCH:TCHannel<0[[1]...6>:DATA:DSElect	<data_list>		
[SOURce<[1]]2>:BB:W3GPP:BSTation:ENHanced:CHANnel<11...13>:DPCH:TCHannel<0[[1]...6>:DATA:PATTern	#B0,1...#B 11...1,64		
[SOURce<[1]]2>:BB:W3GPP:BSTation:ENHanced:CHANnel<11...13>:DPCH:TCHannel<0[[1]...6>:DTX	0 ... 1024		
[SOURce<[1]]2>:BB:W3GPP:BSTation:ENHanced:CHANnel<11...13>:DPCH:TCHannel<0[[1]...6>:EPRotecton	NONE   TURBo3   CON2  CON3		
[SOURce<[1]]2>:BB:W3GPP:BSTation:ENHanced:CHANnel<11...13>:DPCH:TCHannel<0[[1]...6>:INTerleaver	ON   OFF		
[SOURce<[1]]2>:BB:W3GPP:BSTation:ENHanced:CHANnel<11...13>:DPCH:TCHannel<0[[1]...6>:RMAtribute	16 ... 1024		
[SOURce<[1]]2>:BB:W3GPP:BSTation:ENHanced:CHANnel<11...13>:DPCH:TCHannel<0[[1]...6>:STATE	ON   OFF		
[SOURce<[1]]2>:BB:W3GPP:BSTation:ENHanced:CHANnel<11...13>:DPCH:TCHannel<0[[1]...6>:TBCount			
[SOURce<[1]]2>:BB:W3GPP:BSTation:ENHanced:CHANnel<11...13>:DPCH:TCHannel<0[[1]...6>:TBSize	0 ... 4096		
[SOURce<[1]]2>:BB:W3GPP:BSTation:ENHanced:CHANnel<11...13>:DPCH:TCHannel<0[[1]...6>:TTInterval	10ms   20ms   40ms	s	
[SOURce<[1]]2>:BB:W3GPP:BSTation[:ENHanced]:CHANnel:HSDPa:DERRor:BIT:LAYer	TRANSport   PHYsical		
[SOURce<[1]]2>:BB:W3GPP:BSTation[:ENHanced]:CHANnel:HSDPa:DERRor:BIT:RATE	10E-7 ... 10E-1		
[SOURce<[1]]2>:BB:W3GPP:BSTation[:ENHanced]:CHANnel:HSDPa:DERRor:BIT:STATe	ON   OFF		
[SOURce<[1]]2>:BB:W3GPP:BSTation[:ENHanced]:CHANnel:HSDPa:DERRor:BLOCK:RATE	10E-4 ... 10E-1		

Command	Parameters	Default unit	Comments
[SOURCE<[1] 2>:]BB:W3GPP:BSTation[:ENHanced]:CHANnel:HSDPa:DERRor:BLOCK:STATE	ON   OFF		
[SOURCE<[1] 2>:]BB:W3GPP:BSTation:ENHanced:PCCPch:CCODing:INTerleaver<[1] 2>	ON   OFF		
[SOURCE<[1] 2>:]BB:W3GPP:BSTation:ENHanced:PCCPch:CCODing:STATE	ON   OFF		
[SOURCE<[1] 2>:]BB:W3GPP:BSTation:ENHanced:PCCPch:CCODing:TYPE	M12K2   M64K   M144K   M384K   AMR		

**[SOURCE<[1]|2>:]BB:W3GPP:BSTation:ENHanced:CHANnel<11...13>:DPCH:CCODing:BPFRame?**

The command queries the number of data bits in the DPDCH component of the frame at the physical layer. The number of data bits depends on the slot format.

The command is a query command and therefore does not have an \*RST value.

**Example:** "BB:W3GP:BST:ENH:CHAN13:DPCH:CCOD:BPFR?"  
'queries the number of data bits

Response: 1  
'the number of data bits is 1

*RST value	Resolution	Options	Dependencies	SCPI
-	-	B10/B11 and B13 K42 SOURCE2 only with second option B9/B10/B11	The value returned depends on the selected slot format (W3GPP:BST:ENH:CHAN<n>:DPCH:SFOR), and if the slot format changes, this changes automatically as well.	Device-specific

[SOURce<[1]]2>:]BB:W3GPP:BSTation:ENHanced:CHANnel<11...13>:DPCH:CCODing:SFORmat 0 ... 16

The command sets the slot format for the selected enhanced DPCH of base station 1. The slot format is fixed for channel-coded measurement channels conforming to the standard - "Reference Measurement Channel". Changing the slot format automatically activates User coding (W3GP:BST:ENH:CHAN<11...13>:DPCH:CCOD:TYPE USER). The slot format also fixes the symbol rate, bits per frame, pilot length and TFCI state parameters.

**Example:** "BB:W3GP:BST:ENH:CHAN13:DPCH:CCOD:SFOR 4"  
'sets slot format 4 for Enhanced DPCH13.

*RST value	Res.	Options	Dependencies	SCPI
8	-	B10/B11 and B13 K42 SOURce2 only with second option B9/B10/B11	When a channel coding type conforming to the standard is selected (W3GP:BST:ENH:CHAN:DPCH:CCOD:TYPE) and channel coding is activated, the slot format is (W3GP:BST:ENH:CHAN:DPCH:CCOD:STAT) automatically set to the associated value.  Changing the slot format automatically activates User coding (W3GP:BST:ENH:CHAN<11...13>:DPCH:CCOD:TYPE USER).  The command sets the symbol rate (W3GP:BST:ENH:CHAN:DPCH:CCOD:SRAT), the bits per frame (W3GP:BST:ENH:CHAN:DPCH:CCOD:BPFR), the pilot length (W3GP:BST1:CHAN:DPCC:PLEN), and the TFCI state (W3GP:BST1:CHAN:DPCC:TFCI_STAT) to the associated values.	Device-specific

[SOURce<[1]]2>:]BB:W3GPP:BSTation:ENHanced:CHANnel<11...13>:DPCH:CCODing:SRATE?

The command queries the symbol rate.

The command is a query command and therefore does not have an \*RST value.

**Example:** "BB:W3GP:BST:ENH:CHAN13:DPCH:CCOD:SRAT?"  
'queries the symbol rate.

Response: 'D30K'  
'the symbol rate of Enhanced DPCH 13 is 30 ksp/s.

*RST value	Resolution	Options	Dependencies	SCPI
-	-	B10/B11 and B13 K42 SOURce2 only with second option B9/B10/B11	The symbol rate depends on the selected slot format (:BB:W3GPP:BST:ENH:CHAN:DPCH:SFOR), and if the slot format changes, this changes automatically as well.	Device-specific

[SOURce<[1]|2>:]BB:W3GPp:BSTation:ENHanced:CHANnel<11...13>:DPCH:CCODing:STATe ON | OFF

The command activates or deactivates channel coding for the selected enhanced DPCH.

**Example:** "BB:W3GP:BST:ENH:CHAN13:DPCH:CCOD:TYPE M12K2"  
'selects channel coding type RMC 12.2 kbps for Enhanced DPCH 13.

"BB:W3GP:BST:ENH:CHAN13:DPCH:CCOD:STAT ON"  
'activates channel coding.

*RST value	Res.	Options	Dependency	SCPI
OFF	-	B10/B11 and B13 K42 SOURce2 only with second option B9/B10/B11	When channel coding is activated and a channel coding type conforming to the standard is selected, (BB:W3GP:BST:ENH:CHAN:DPCH:CCOD:TYPE) the slot format, (BB:W3GP:BST:ENH:CHAN:DPCH:CCOD:SFOR) and thus the symbol rate, (BB:W3GP:BST:ENH:CHAN:DPCH:CCOD:SRAT) the bits per frame, (BB:W3GP:BST:ENH:CHAN:DPCH:CCOD:BPFR), the pilot length (BB:W3GP:BST1:CHAN:DPCC:PLEN) and the TFCI state (BB:W3GP:BST1:CHAN:DPCC:TFCI STAT) are set to the associated values.	Device-specific

[SOURce<[1]>:]BB:W3GPP:BSTation:ENHanced:CHANnel<11...13>:DPCH:CCODing:TYPE  
M12K2 | M64K | M144k | M384k | AMR | BTFD1 | BTFD2 | BTFD3

The command selects the channel coding scheme in accordance with the 3GPP specification.

The 3GPP specification defines 4 reference measurement channel coding types, which differ in the input data bit rate to be processed (12.2, 64, 144 and 384 kbps). The additional AMR CODER coding scheme generates the coding of a voice channel.

**Parameters: M12K2**

Measurement channel with an input data bit rate of 12.2 kbps.

**M64K**

Measurement channel with an input data bit rate of 64 kbps.

**M144k**

Measurement channel with an input data bit rate of 144 kbps.

**M384k**

Measurement channel with an input data bit rate of 384 kbps.

**AMR**

Channel coding for the AMR Coder (coding a voice channel).

**USER**

This parameter cannot be set. USER is returned whenever a user-defined channel coding is active, that is to say, after a channel coding parameter has been changed or a user coding file has been loaded. The file is loaded by the command :BB:W3GP:BST:ENH:CHAN:DPCH:CCOD:USER:LOAD

**BTFD1**

Blind Transport Format Detection Rate 1 (12.2 kbps).

**BTFD2**

Blind Transport Format Detection Rate 2 (7.95 kbps).

**BTFD3**

Blind Transport Format Detection Rate 3 (1.95 kbps)

**Example:**

"BB:W3GP:BST:ENH:CHAN13:DPCH:CCOD:TYPE M144"  
'selects channel coding scheme RMC 144 kbps.

*RST value	Options	Dependency	SCPI
M12K2	B10/B11 and B13 K42 SOURce2 only with second option B9/B10/B11	When a channel coding type conforms to the standard and channel coding is activated, (:BB:W3GP:BST:ENH:CHAN<n>:DPCH:CCOD:STAT) the slot format (:BB:W3GP:BST:ENH:CHAN<n>:DPCH:CCOD:SFOR) and thus the symbol rate (:BB:W3GP:BST:ENH:CHAN<n>:DPCH:CCOD:SRAT) the bits per frame, (:BB:W3GP:BST:ENH:CHAN<n>:DPCH:CCOD:BPFR), the pilot length (:BB:W3GP:BST1:CHAN<n>:DPCC:PLEN) and the TFCl state (:BB:W3GP:BST1:CHAN<n>:DPCC:TFCI:STAT) are set to the associated values.	Device-specific



[SOURce<[1]]2>:]BB:W3GPP:BSTation:ENHanced:CHANnel:DPCH:CCODing:USER:CATalog?

The command queries existing files with stored user channel codings.

The files are stored with the fixed file extensions \*.3g\_ccod\_dl in a directory of the user's choice. The directory applicable to the commands is defined with the command MMEMoRY:CDIR.

The numerical suffix at CHANnel must not be used for this command.

**Example:** "MMEMoRY:CDIR 'D:\Lists\Wcdma\CcodDpchUser'"  
'selects the directory for the user channel coding files.

"BB:W3GP:BST:ENH:CHAN:DPCH:CCOD:USER:CAT?"  
'queries the existing files with user coding.

Response: "'user\_cc1'"  
'there is one file with user coding.

*RST value	Resolution	Options	SCPI
-	-	B10/B11 and B13 K42 SOURce2 only with second option B9/B10/B11	Device-specific

[SOURce<[1]]2>:]BB:W3GPP:BSTation:ENHanced:CHANnel:DPCH:CCODing:USER:DELeTe <user\_coding>

The command deletes the specified files with stored user channel codings.

The files are stored with the fixed file extensions \*.3g\_ccod\_dl in a directory of the user's choice. The directory applicable to the commands is defined with the command MMEMoRY:CDIR. To access the files in this directory, you only have to give the file name, without the path and the file extension.

The numerical suffix at CHANnel must not be used for this command.

The command triggers an event and therefore has no query form and no \*RST value.

**Example:** "MMEMoRY:CDIR 'D:\Lists\Wcdma\CcodDpchUser'"  
'selects the directory for the user channel coding files.

"BB:W3GP:BST:ENH:CHAN:DPCH:CCOD:USER:DEL 'user\_cc1'"  
'deletes the specified file with user coding.

*RST value	Resolution	Options	SCPI
-	-	B10/B11 and B13 K42 SOURce2 only with second option B9/B10/B11	Device-specific

**[SOURce<[1]|2>:]BB:W3GPP:BSTation:ENHanced:CHANnel<11...13>:DPCH:CCODing:USER:LOAD <user\_coding>**

The command loads the specified files with stored user channel codings.

The files are stored with the fixed file extensions \*.3g\_ccod\_dl in a directory of the user's choice. The directory applicable to the commands is defined with the command MMEMoRY:CDIR. To access the files in this directory, you only have to give the file name, without the path and the file extension.

The command triggers an event and therefore has no query form and no \*RST value.

**Example:**           "MMEM:CDIR 'D:\Lists\Wcdma\CcodDpchUser'"  
                          'selects the directory for the user channel coding files.  
                          "BB:W3GP:BST:ENH:CHAN13:DPCH:CCOD:USER:LOAD 'user\_cc1'"  
                          'loads the specified file with user coding.

*RST value	Resolution	Options	SCPI
-	-	B10/B11 and B13 K42 SOURce2 only with second option B9/B10/B11	Device-specific

**[SOURce<[1]|2>:]BB:W3GPP:BSTation:ENHanced:CHANnel<11...13>:DPCH:CCODing:USER:STORE <user\_coding>**

The command saves the current settings for channel coding as user channel coding in the specified file.

The files are stored with the fixed file extensions \*.3g\_ccod\_dl in a directory of the user's choice. The directory in which the file is stored is defined with the command MMEMoRY:CDIR. To store the files in this directory, you only have to give the file name, without the path and the file extension.

The numerical suffix at CHANnel has no significance for this command.

The command triggers an event and therefore has no query form and no \*RST value.

**Example:**           "MMEM:CDIR 'D:\Lists\Wcdma\CcodDpchUser'"  
                          'selects the directory for the user channel coding files.  
                          "BB:W3GP:BST:ENH:CHAN13:DPCH:CCOD:USER:STOR 'user\_cc1'"  
                          'saves the current channel coding setting in file user\_cc1 in directory  
                          D:\Lists\Wcdma\CcodDpchUser.

*RST value	Resolution	Options	SCPI
-	-	B10/B11 and B13 K42 SOURce2 only with second option B9/B10/B11	Device-specific

[SOURCE<[1]>:]BB:W3GPP:BSTation:ENHanced:CHANnel<11...13>:DPCH:DERRor:BIT:LAYer  
TRANsport | PHYSical

The command selects the layer in the coding process in which bit errors are inserted.

**Parameters:**     **TRANsport**  
                          Transport Layer (Layer 2). This layer is only available when channel coding is active.

**PHYSical**  
                          Physical layer (Layer 1).

**Example:**           "BB:W3GP:BST:ENH:CHAN13:DPCH:DERR:BIT:LAY PHYS"  
                          'selects layer 1 for entering bit errors.

*RST value	Resolution	Options	SCPI
PHYSical	-	B10/B11 and B13 K42 SOURCE2 only with second option B9/B10/B11	Device-specific

[SOURCE<[1]>:]BB:W3GPP:BSTation:ENHanced:CHANnel<11...13>:DPCH:DERRor:BIT:RATE  
1E-7 ... 5E-1

The command sets the bit error rate.

**Example:**           "BB:W3GP:BST:ENH:CHAN13:DPCH:DERR:BIT:RATE 1E-4"  
                          'sets a bit error rate of 0.0001.

*RST value	Resolution	Options	SCPI
5E-3	-	B10/B11 and B13 K42 SOURCE2 only with second option B9/B10/B11	Device-specific

[SOURCE<[1]>:]BB:W3GPP:BSTation:ENHanced:CHANnel<11...13>:DPCH:DERRor:BIT:STATE  
ON | OFF

The command activates bit error generation or deactivates it.

Bit errors are inserted into the data fields of the enhanced channels. When channel coding is active, it is possible to select the layer in which to insert the errors (the physical or the transport layer, SOURCE:BB:W3GP:BST:ENH:CHAN13:DPCH:DERR:BIT:LAY ). When the data source is read out, individual bits are deliberately inverted at random points in the data bit stream at the specified error rate in order to simulate an invalid signal.

**Example:**           "BB:W3GP:BST:ENH:CHAN13:DPCH:DERR:BIT:STAT ON"  
                          'activates bit error generation.

*RST value	Resolution	Options	SCPI
OFF	-	B10/B11 and B13 K42 SOURCE2 only with second option B9/B10/B11	Device-specific

[SOURce<[1]|2>:]BB:W3GpP:BSTation:ENHanced:CHANnel<11...13>:DPCH:DERRor:BLOCK:RATE  
1E-4 ... 5E-1

The command sets the block error rate.

**Example:** "BB:W3GP:BST:ENH:CHAN13:DPCH:DERR:BLOC:RATE 1E-2"  
'sets the block error rate to 0.01.

*RST value	Resolution	Options	SCPI
5E-1	-	B10/B11 and B13 K42 SOURce2 only with second option B9/B10/B11	Device-specific

[SOURce<[1]|2>:]BB:W3GpP:BSTation:ENHanced:CHANnel<11...13>:DPCH:DERRor:BLOCK:STATE  
ON | OFF

The command activates or deactivates block error generation . Block error generation is only possible when channel coding is activated.

During block error generation, the CRC checksum is determined and then the last bit is inverted at the specified error probability in order to simulate a defective signal.

**Example:** "BB:W3GP:BST:ENH:CHAN13:DPCH:CCOD:STAT ON"  
'activates channel coding.  
"BB:W3GP:BST:ENH:CHAN13:DPCH:DERR:BLOC:RATE 5E-1"  
'sets the block error rate to 0.1.  
"BB:W3GP:BST:ENH:CHAN13:DPCH:DERR:BLOC:STAT ON"  
'activates block error generation.

*RST value	Resolution	Options	SCPI
OFF	-	B10/B11 and B13 K42 SOURce2 only with second option B9/B10/B11	Device-specific

[SOURce<[1]|2>:]BB:W3GpP:BSTation:ENHanced:CHANnel<11...13>:DPCH:DPCControl:DIRection  
UP | DOWN

The command selects the Dynamic Power Control direction. The selected mode determines if the channel power is increased (UP) or decreased (DOWN) by a control signal with high level.

**Example:** "BB:W3GP:BST:ENH:CHAN11:DPCH:DPC:DIR UP"  
'selects mode up, a high level of the control signals leads to an increase of the channel power of DPCH 11.

*RST value	Resolution	Options	SCPI
UP	-	B10/B11 and B13 K42 SOURce2 only with second option B9/B10/B11	Device-specific

**[SOURce<[1]>:]BB:W3GPp:BSTation:ENHanced:CHANnel<11...13>:DPCH:DPControl:MODE**  
 EXTernal | TPC | MANual

The command selects the control signal source for Dynamic Power Control.

**Example:** "BB:W3GP:BST:ENH:CHAN11:DPCH:DPC:MODE EXT"  
 'selects external power control. The control signal is supplied via the LEV ATT input of the AUX I/O connector (path A).

*RST value	Resolution	Options	SCPI
EXT	-	B10/B11 and B13 K42 SOURce2 only with second option B9/B10/B11	Device-specific

**[SOURce<[1]>:]BB:W3GPp:BSTation:ENHanced:CHANnel<11...13>:DPCH:DPControl[:POWER]**

The command queries the deviation of the channel power ( $\Delta$ POW) from the set power start value of the corresponding enhanced channels.

The command is a query command and therefore does not have an \*RST value.

**Example:** "BB:W3GP:BST:ENH:CHAN11:DPCH:DPC? "  
 'queries the deviation of the channel power of DPCH 11.

*RST value	Resolution	Options	SCPI
	-	B10/B11 and B13 K42 SOURce2 only with second option B9/B10/B11	Device-specific

**[SOURce<[1]>:]BB:W3GPp:BSTation:ENHanced:CHANnel<11...13>:DPCH:DPControl:RANGe:DOWN**  
 0 dB ... 30 dB

The command selects the dynamic range for ranging down the channel power.

**Example:** "BB:W3GP:BST:ENH:CHAN11:DPCH:DPC:RANG:DOWN 20 dB"  
 'selects a dynamic range of 20 dB for ranging down the channel power of DPCH 11.

*RST value	Resolution	Options	SCPI
10 dB	0.01 dB	B10/B11 and B13 K42 SOURce2 only with second option B9/B10/B11	Device-specific

[SOURce<[1]>:]BB:W3GPP:BSTation:ENHanced:CHANnel<11...13>:DPCH:DPControl:RANGE:UP  
P 0 dB ... 30 dB

The command selects the dynamic range for ranging up the channel power.

**Example:** "BB:W3GP:BST:ENH:CHAN11:DPCH:DPC:RANG:UP 20 dB"  
'selects a dynamic range of 20 dB for ranging up the channel power of DPCH 11.

*RST value	Resolution	Options	SCPI
10 dB	0.01 dB	B10/B11 and B13 K42 SOURce2 only with second option B9/B10/B11	Device-specific

[SOURce<[1]>:]BB:W3GPP:BSTation:ENHanced:CHANnel<11...13>:DPCH:DPControl:STATE  
ON | OFF

The command activates/deactivates Dynamic Power Control.

**Example:** "BB:W3GP:BST:ENH:CHAN11:DPCH:DPC:STAT ON"  
'activates Dynamic Power Control for DPCH 11.

*RST value	Resolution	Options	SCPI
OFF	-	B10/B11 and B13 K42 SOURce2 only with second option B9/B10/B11	Device-specific

[SOURce<[1]>:]BB:W3GPP:BSTation:ENHanced:CHANnel<11...13>:DPCH:DPControl:STEP[:EXTer  
nal] 0.5 dB ... 6.0 dB

This command sets step width by which – with Dynamic Power Control being switched on - the channel power of the selected enhanced channel is increased or decreased.

**Example:** "BB:W3GP:BST:ENH:CHAN11:DPCH:DPC:DIR UP"  
'selects direction up, a high level of the control signals leads to an increase of the channel power of DPCH 11.

"BB:W3GP:BST:ENH:CHAN11:DPCH:DPC:RANG:UP 10 dB"  
'selects a dynamic range of 10 dB for ranging up the channel power.

"BB:W3GP:BST:ENH:CHAN11:DPCH:DPC:RANG:DOWN 10 dB"  
'selects a dynamic range of 10 dB for ranging down the channel power .

"BB:W3GP:BST:ENH:CHAN11:DPCH:DPC:STEP 0.5 dB"  
'selects a step width of 0.5 dB. A high level of the control signal leads to an increase of 0.5 dB of the channel power, a low level to a decrease of 0.5 dB. The overall increase and decrease of channel power is limited to 10 dB each.

"BB:W3GP:BST:ENH:CHAN11:DPCH:DPC:MODE EXT"  
'selects external power control.

"BB:W3GP:BST:ENH:CHAN11:DPCH:DPC:STAT ON"  
'activates Dynamic Power Control.

*RST value	Resolution	Options	SCPI
1 dB	0.01 dB	B10/B11 and B13 K42 SOURce2 only with second option B9/B10/B11	Device-specific

[SOURCE<[1]>:]BB:W3GPP:BSTation:ENHanced:CHANnel<11...13>:DPCH:DPControl:STEP:MANual MAN0 | MAN1

This command provides the control signal for manual mode of Dynamic Power Control.

The command triggers an event and therefore has no query form and no \*RST value.

- Example:**
- "BB:W3GP:BST:ENH:CHAN11:DPCH:DPC:DIR UP"  
'selects direction up, a high level of the control signals leads to an increase of the channel power of DPCH 11.
  - "BB:W3GP:BST:ENH:CHAN11:DPCH:DPC:RANG:UP 10 dB"  
'selects a dynamic range of 10 dB for ranging up the channel power of DPCH 11.
  - "BB:W3GP:BST:ENH:CHAN11:DPCH:DPC:RANG:DOWN 10 dB"  
'selects a dynamic range of 10 dB for ranging down the channel power of DPCH 11.
  - "BB:W3GP:BST:ENH:CHAN11:DPCH:DPC:STEP 0.5 dB"  
'selects a step width of 0.5 dB. A high level of the control signal leads to an increase of 0.5 dB of the channel power, a low level to a decrease of 0.5 dB. The overall increase and decrease of channel power is limited to 10 dB each.
  - "BB:W3GP:BST:ENH:CHAN11:DPCH:DPC:MODE MAN"  
'selects manual power control.
  - "BB:W3GP:BST:ENH:CHAN11:DPCH:DPC:STAT ON"  
'activates Dynamic Power Control for DPCH 11.
  - "BB:W3GP:BST:ENH:CHAN11:DPCH:DPC:STEP:MAN MAN0"  
'the power is decreased by 0.5 dB.

*RST value	Resolution	Options	SCPI
MAN1		B10/B11 and B13 K42 SOURCE2 only with second option B9/B10/B11	Device-specific

[SOURCE<[1]>:]BB:W3GPP:BSTation:ENHanced:CHANnel<11...13>:DPCH:INTERleaver2 ON | OFF

The command activates or deactivates channel coding interleaver state 2 for the selected channel.

Interleaver state 2 is activated or deactivated for all the transport channels together. Interleaver state 1 can be activated and deactivated for each transport channel individually (command SOURCE:BB:W3GP:BST [ 1 ] :ENH:CHAN<n>:DPCH:TCH<n>:INT).

**Note:**

*The interleaver states do not cause the symbol rate to change*

- Example**
- "BB:W3GP:BST:ENH:CHAN13:DPCH:INT OFF"  
'deactivates channel coding interleaver state 2 for all the TCHs of DPCH13.

*RST value	Resolution	Options	SCPI
ON	-	B10/B11 and B13 K42 SOURCE2 only with second option B9/B10/B11	Device-specific

[SOURce<[1]|2>:]BB:W3Gpp:BSTation:ENHanced:CHANnel<11...13>:DPCH:STATe ON | OFF

The command switches the selected channel to the enhanced state.

**Example:** "BB:W3GP:BST:ENH:CHAN13:DPCH:STAT ON"  
'switches DPCH 13 to Enhanced State.

*RST value	Resolution	Options	SCPI
OFF	-	B10/B11 and B13; K42 SOURce2 only with second option B9/B10/B11	Device-specific

[SOURce<[1]|2>:]BB:W3Gpp:BSTation:ENHanced:CHANnel<11...13>:DPCH:TCHannel<0|[1]...6>:CRCSize NONE | 8 | 12 | 16 | 24

The command defines the CRC length for the selected transport channel. It is also possible to deactivate checksum determination.

**Note:**

The transport channel designations for remote control are TCHannel0 for DCCH, TCHannel1 to TCHannel6 for DTCH1 to DTCH6.

**Example:** "BB:W3GP:BST:ENH:CHAN13:DPCH:TCH0:CRCS NONE"  
'deactivates checksum determination for the DCCH of DPCH13.

*RST value	Resolution	Options	SCPI
16	-	B10/B11 and B13; K42 SOURce2 only with second option B9/B10/B11	Device-specific

[SOURce<[1]|2>:]BB:W3Gpp:BSTation:ENHanced:CHANnel<11...13>:DPCH:TCHannel<0|[1]...6>:DATA PN9 | PN15 | PN16 | PN20 | PN21 | PN23 | DLISt | ZERO | ONE | PATTern

The command determines the data source for the data fields of enhanced channels with channel coding. If channel coding is not active, the DPCH data source is used (:SOURce:BB:W3Gpp:BST:CHANnel:DATA).

**Note:**

The transport channel designations for remote control are TCHannel0 for DCCH, TCHannel1 to TCHannel6 for DTCH1 to DTCH6.

**Example:** "BB:W3GP:BST:ENH:CHAN13:DPCH:TCH1:DATA PATT"  
'selects the Pattern data source for the data fields of DTCH1 of DPCH13. The bit pattern is defined with the following command.  
"BB:W3GP:BST:ENH:CHAN13:DPCH:TCH1:DATA:PATT #H3F,8"  
'defines the bit pattern.

*RST value	Resolution	Options	SCPI
PN9	-	B10/B11 and B13 K42 SOURce2 only with second option B9/B10/B11	Device-specific



[SOURce<[1]>:]BB:W3GPp:BSTation:ENHanced:CHANnel<11...13>:DPCH:TCHannel<0|[1]...6>:DATA:DSElect <data list name>

The command selects the data list for enhanced channels for the DLIS selection.

The files are stored with the fixed file extensions \*.dm\_iqd in a directory of the user's choice. The directory applicable to the commands is defined with the command MMEMoRY:CDIR. To access the files in this directory, you only have to give the file name, without the path and the file extension.

**Note:**

The transport channel designations for remote control are TCHannel0 for DCCH, TCHannel1 to TCHannel6 for DTCH1 to DTCH6.

**Example:**

```
"BB:W3GP:BST:ENH:CHAN13:DPCH:TCH1:DATA DLIS"
  'selects the Data Lists data source for DTCH1 of DPCH13.

"MMEM:CDIR 'D:\Lists\Dm\IQData'"
  'selects the directory for the data lists.

"BB:W3GP:BST:ENH:CHAN13:DPCH:TCH1:DATA:DSEL 'bts_tch'"
  'selects the file 'bts_tch' as the data source.
```

*RST value	Resolution	Options	SCPI
-	-	B10/B11 and B13 K42 SOURce2 only with second option B9/B10/B11	Device-specific

[SOURce<[1]>:]BB:W3GPp:BSTation:ENHanced:CHANnel<11...13>:DPCH:TCHannel<0|[1]...6>:DATA:PATtern #B0,1 ... #B111..1, 64

The command determines the bit pattern for the PATtern selection. The maximum length is 64 bits.

**Note:**

The transport channel designations for remote control are TCHannel0 for DCCH, TCHannel1 to TCHannel6 for DTCH1 to DTCH6.

**Example:**

```
"BB:W3GP:BST:ENH:CHAN13:DPCH:TCH1:DATA:PATT #H3F, 8"
  'defines the bit pattern.
```

*RST value	Resolution	Options	SCPI
#H0, 1	-	B10/B11 and B13 K42 SOURce2 only with second option B9/B10/B11	Device-specific

[SOURce<[1]>:]BB:W3GPP:BSTation:ENHanced:CHANnel<11...13>:DPCH:TCHannel<0|[1]...6>:DTX 0 ... 1024

The command sets the number of DTX (Discontinuous Transmission) bits. These bits are entered in the data stream between rate matching and interleaver 1 and used for the BTFD reference measurement channels rate 2 and rate 3.

**Example:** "BB:W3GP:BST:ENH:CHAN13:DPCH:TCH1:DTX 257"  
'257 bits are entered in the data stream between rate matching and interleaver 1.'

*RST value	Resolution	Options	SCPI
0	-	B10/B11 and B13 K42 SOURce2 only with second option B9/B10/B11	Device-specific

[SOURce<[1]>:]BB:W3GPP:BSTation:ENHanced:CHANnel<11...13>:DPCH:TCHannel<0|[1]...6>:EPRotectioN NONE | TURBo3 | CON2 | CON3

The command determines the error protection.

**Note:**

The transport channel designations for remote control are TCHannel0 for DCCH, TCHannel1 to TCHannel6 for DTCH1 to DTCH6.

**Parameters:** **NONE**  
No error protection

**TURBo3**  
Turbo Coder of rate 1/3 in accordance with the 3GPP specifications.

**CON2 | CON3**  
Convolution Coder of rate 1/2 or 1/3 with generator polynomials defined by 3GPP.

**Example:** "BB:W3GP:BST:ENH:CHAN13:DPCH:TCH1:EPR NONE"  
'error protection for transport channel DTCH1 of DPCH13 is deactivated'

*RST value	Resolution	Options	SCPI
CON3	-	B10/B11 and B13 K42 SOURce2 only with second option B9/B10/B11	Device-specific

[SOURce<[1]|2>:]BB:W3GPp:BSTation:ENHanced:CHANnel<11...13>:DPCH:TCHannel<0|[1]...6>:INTerleaver ON | OFF

The command activates or deactivates channel coding interleaver state 1 for the selected channel.

Interleaver state 1 can be activated and deactivated for each transport channel individually. The channel is selected via the suffix at TCHannel.

Interleaver state 2 can only be activated or deactivated for all the transport channels together.

SOUR:BB:W3GP:BST:ENH:CHAN<n>:DPCH:INT)

**Note:**

*The interleaver states do not cause the symbol rate to change.*

*The transport channel designations for remote control are TCHannel0 for DCCH, TCHannel1 to TCHannel6 for DTCH1 to DTCH6.*

**Example**

"BB:W3GP:BST:ENH:CHAN13:DPCH:TCH5:INT OFF"  
'deactivates channel coding interleaver state 1 for DTCH5 of DPCH13.

*RST value	Resolution	Options	SCPI
ON	-	B10/B11 and B13 K42 SOURce2 only with second option B9/B10/B11	Device-specific

[SOURce<[1]|2>:]BB:W3GPp:BSTation:ENHanced:CHANnel<11...13>:DPCH:TCHannel<0|[1]...6>:RMAtribute 16 ... 1024

The command sets data rate matching (Rate Matching).

**Note:**

*The transport channel designations for remote control are TCHannel0 for DCCH, TCHannel1 to TCHannel6 for DTCH1 to DTCH6.*

**Example:**

"BB:W3GP:BST:ENH:CHAN13:DPCH:TCH1:RMA 1024"  
'sets the rate matching attribute for DTCH1 of DPCH13 to 1024.

*RST value	Resolution	Options	SCPI
256	-	B10/B11 and B13 K42 SOURce2 only with second option B9/B10/B11	Device-specific

[SOURce<[1]>:]BB:W3GPP:BSTation:ENHanced:CHANnel<11...13>:DPCH:TCHannel<0|[1]...6>:STATe ON | OFF

The command activates/deactivates the selected transport channel.

**Note:**

The transport channel designations for remote control are TCHannel0 for DCCH, TCHannel1 to TCHannel6 for DTCH1 to DTCH6.

**Example:** "BB:W3GP:BST:ENH:CHAN13:DPCH:TCH1:STAT ON"  
'activates DTCH1 of DPCH13

*RST value	Resolution	Options	SCPI
OFF	-	B10/B11 and B13 K42 SOURce2 only with second option B9/B10/B11	Device-specific

[SOURce<[1]>:]BB:W3GPP:BSTation:ENHanced:CHANnel<11...13>:DPCH:TCHannel<0|[1]...6>:TBCout 1 ... 16

The command defines the number of blocks used for the selected transport channel.

**Note:**

The transport channel designations for remote control are TCHannel0 for DCCH, TCHannel1 to TCHannel6 for DTCH1 to DTCH6.

**Example:** "BB:W3GP:BST:ENH:CHAN13:DPCH:TCH:TBC 4"  
'sets 4 transport blocks for DTCH1 of DPCH13.

*RST value	Resolution	Options	SCPI
4	-	B10/B11 and B13 K42 SOURce2 only with second option B9/B10/B11	Device-specific

[SOURce<[1]>:]BB:W3GPP:BSTation:ENHanced:CHANnel<11...13>:DPCH:TCHannel<0|[1]...6>:TBSize 0 - 4096

The command sets the size of the data blocks.

**Note:**

The transport channel designations for remote control are TCHannel0 for DCCH, TCHannel1 to TCHannel6 for DTCH1 to DTCH6.

**Example:** "BB:W3GP:BST:ENH:CHAN13:DPCH:TCH:TBS 1024"  
'sets the length of the transport blocks for DTCH1 of DPCH13 to 1024.

*RST value	Resolution	Options	SCPI
100	-	B10/B11 and B13 K42 SOURce2 only with second option B9/B10/B11	Device-specific

[SOURCE<[1]>:]BB:W3GPP:BSTation:ENHanced:CHANnel<11...13>:DPCH:TCHannel<0|[1]...6>:TTINterval  
10MS | 20MS | 40MS

The command sets the number of frames into which a TCH is divided. This setting also defines the interleaver depth.

**Note:**

The transport channel designations for remote control are TCHannel0 for DCCH, TCHannel1 to TCHannel6 for DTCH1 to DTCH6.

**Example:** "BB:W3GP:BST:ENH:CHAN13:DPCH:TCH1:TTIN 20ms  
'sets that DTCH1 of DPCH13 is divided into 2 frames.

*RST value	Resolution	Options	SCPI
40MS	-	B10/B11 and B13 K42 SOURCE2 only with second option B9/B10/B11	Device-specific

[SOURCE<[1]>:]BB:W3GPP:BSTation[:ENHanced]:CHANnel12:HSDPa:DERRor:BIT:LAYer  
TRANsport | PHYSical

The command selects the layer in the coding process in which bit errors are inserted.

**Parameters:**     **TRANsport**  
                  Transport Layer (Layer 2).

**PHYSical**  
                  Physical layer (Layer 1).

**Example:** "BB:W3GP:BST:ENH:CHAN12:HSDP:DERR:BIT:LAY PHYS"  
'selects layer 1 for entering bit errors.

*RST value	Resolution	Options	SCPI
PHYSical	-	B10/B11 and B13 K42 SOURCE2 only with second option B9/B10/B11	Device-specific

[SOURCE<[1]>:]BB:W3GPP:BSTation[:ENHanced]:CHANnel12:HSDPa:DERRor:BIT:RATE  
1E-7 to 5E-1

The command sets the bit error rate.

**Example:** "BB:W3GP:BST:ENH:CHAN12:HSDP:DERR:BIT:RATE 1E-4"  
'sets a bit error rate of 0.0001.

*RST value	Resolution	Options	SCPI
5E-3	-	B10/B11 and B13 K42 SOURCE2 only with second option B9/B10/B11	Device-specific

[SOURce<[1]>:]BB:W3GPP:BSTation[:ENHanced]:CHANnel12:HSDPa:DERRor:BIT:STATe  
ON | OFF

The command activates bit error generation or deactivates it.

Bit errors are inserted into the data stream of the coupled HS-PDSCHs. It is possible to select the layer in which the errors are inserted (physical or transport layer). When the data source is read out, individual bits are deliberately inverted at random points in the data bit stream at the specified error rate in order to simulate an invalid signal.

**Example:**           "BB:W3GP:BST:ENH:CHAN12:HSDP:DERR:BIT:STAT ON"  
                          'activates bit error generation.

*RST value	Resolution	Options	SCPI
OFF	-	B10/B11 and B13 K42 SOURce2 only with second option B9/B10/B11	Device-specific

[SOURce<[1]>:]BB:W3GPP:BSTation[:ENHanced]:CHANnel12:HSDPa:DERRor:BLOCK:RATE  
1E-4 ... 5E-1

The command sets the block error rate.

**Example:**           "BB:W3GP:BST:ENH:CHAN12:HSDP:DERR:BLOC:RATE 1E-2"  
                          'sets the block error rate to 0.01.

*RST value	Resolution	Options	SCPI
5E-1	-	B10/B11 and B13 K42 SOURce2 only with second option B9/B10/B11	Device-specific

[SOURce<[1]>:]BB:W3GPP:BSTation[:ENHanced]:CHANnel12:HSDPa:DERRor:BLOCK:STATe  
ON | OFF

The command activates or deactivates block error generation . During block error generation, the CRC checksum is determined and then the last bit is inverted at the specified error probability in order to simulate a defective signal.

**Example:**           "BB:W3GP:BST:ENH:CHAN12:HSDP:DERR:BLOC:RATE 5E-1"  
                          'sets the block error rate to 0.1.  
  
                          "BB:W3GP:BST:ENH:CHAN12:HSDP:DERR:BLOC:STAT ON"  
                          'activates block error generation.

*RST value	Resolution	Options	SCPI
OFF	-	B10/B11 and B13 K42 SOURce2 only with second option B9/B10/B11	Device-specific

[SOURce<[1]|2>:]BB:W3GPp:BSTation:ENHanced:PCCPch:CCODing:INTERleaver<[1]|2> ON | OFF

The command activates or deactivates channel coding interleaver state 1 or 2 for the P-CCPCH.

**Note:**

*The interleaver states do not cause the symbol rate to change*

**Example:**

"BB:W3GP:BST:ENH:PCCP:CCOD:INT1 OFF"  
'deactivates channel coding interleaver state 1 for the P-CCPCH.

*RST value	Resolution	Options	SCPI
ON	-	B10/B11 and B13 K42 SOURce2 only with second option B9/B10/B11	Device-specific

[SOURce<[1]|2>:]BB:W3GPp:BSTation:ENHanced:PCCPch:CCODing:STATE ON | OFF

The command activates or deactivates channel coding for the enhanced P-CCPCH. The coding scheme of the P-CCPCH (BCH) is defined in the standard.

**Example:**

"BB:W3GP:BST:ENH:PCCP:CCOD:STAT ON"  
'activates channel coding for the enhanced P-CCPCH.

*RST value	Resolution	Options	SCPI
OFF	-	B10/B11 and B13 K42 SOURce2 only with second option B9/B10/B11	Device-specific

[SOURce<[1]|2>:]BB:W3GPp:BSTation:ENHanced:PCCPch:CCODing:TYPE?

The command queries the channel coding scheme in accordance with the 3GPP specification. The coding scheme of the P-CCPCH (BCH) is defined in the standard. The channel is generated automatically with the counting system frame number (SFN). The system information after the SFN field is completed from the selected data source.

The command is a query command and therefore does not have an \*RST value.

**Example:**

"BB:W3GP:BST:ENH:PCCP:CCOD:TYPE?"  
'queries the channel coding scheme of the P-CCPCH.

Response: 'BCHS '  
'the channel coding scheme with SFN is used.

*RST value	Resolution	Options	SCPI
-	-	B10/B11 and B13 K42 SOURce2 only with second option B9/B10/B11	Device-specific

**[SOURce<[1]|2>:]BB:W3Gpp:BSTation:ENHanced:PCCPch:STATe ON | OFF**

The command activates or deactivates the enhanced state of the P-CCPCH (BCH).

**Example:** "BB:W3GP:BST:ENH:PCCP:STAT ON  
'switches the P-CCPCH to Enhanced State.

RST value	Resolution	Options	SCPI
OFF	-	B10/B11 and B13 K42 SOURce2 only with second option B9/B10/B11	Device-specific



## SOURce:W3GPP - User Equipment Settings

The SOURce:BB:W3GPP:MSTation system contains commands for setting the user equipment. The commands of this system only take effect when the 3GPP FDD standard is activated, the UP transmission direction is selected and the particular user equipment is enabled:

SOURce:BB:W3GPP:STATe ON

SOURce:BB:W3GPP:LINK UP

SOURce:BB:W3GPP:MSTation2:STATe ON

The commands for setting the enhanced channels of user equipment 1 are described in the following section.

Command	Parameters	Default unit	Comments
[SOURce<[1]]2>:BB:W3GPP:MSTation:ADDITIONal:COUNT	1...128		
[SOURce<[1]]2>:BB:W3GPP:MSTation:ADDITIONal:POWer:OFFSet	-80dB ... 0dB	<b>dB</b>	
[SOURce<[1]]2>:BB:W3GPP:MSTation:ADDITIONal:SCODE:STEP	#H0...#HFFFF FF		
[SOURce<[1]]2>:BB:W3GPP:MSTation:ADDITIONal:STATe	ON   OFF		
[SOURce<[1]]2>:BB:W3GPP:MSTation:ADDITIONal:TDELay:STEP	1chip...1 frame	<b>chips</b>	
[SOURce<[1]]2>:BB:W3GPP:MSTation<[1]]2 3 4>:CHANnel<[1]...6>:DPDCh:CCODe?			Query only
[SOURce<[1]]2>:BB:W3GPP:MSTation<[1]]2 3 4>:CHANnel<[1]...6>:DPDCh:DATA	PN9   PN15   PN16   PN20   PN21   PN23   ZERO   ONE   DLISt   PATTern		
[SOURce<[1]]2>:BB:W3GPP:MSTation<[1]]2 3 4>:CHANnel<[1]...6>:DPDCh:DATA:DCCH	PN9   PN15   PN16   PN20   PN21   PN23   ONE   ZERO   PATTern   DLISt		
[SOURce<[1]]2>:BB:W3GPP:MSTation<[1]]2 3 4>:CHANnel<[1]...6>:DPDCh:DATA:DCCH:DSElect	<data_list>		
[SOURce<[1]]2>:BB:W3GPP:MSTation<[1]]2 3 4>:CHANnel<[1]...6>:DPDCh:DATA:DCCH:PATTern	#B0,1...B11..1, 64		
[SOURce<[1]]2>:BB:W3GPP:MSTation<[1]]2 3 4>:CHANnel<[1]...6>:DPDCh:DATA:DSElect	<data_list>		
[SOURce<[1]]2>:BB:W3GPP:MSTation<[1]]2 3 4>:CHANnel<[1]...6>:DPDCh:DATA:PATTern	#B0,1...B11..1, 64		
[SOURce<[1]]2>:BB:W3GPP:MSTation<[1]]2 3 4>:CHANnel<[1]...6>:DPDCh:SRATe			Query only
[SOURce<[1]]2>:BB:W3GPP:MSTation<2 3 4>:CMODE:METHod	HLScheduling   SF2		
[SOURce<[1]]2>:BB:W3GPP:MSTation<2 3 4>:CMODE:PATTern<[1]]2>:TGD	3...100 slots		
[SOURce<[1]]2>:BB:W3GPP:MSTation<2 3 4>:CMODE:PATTern<[1]]2>:TGL<[1]]2>	3...14 slots		
[SOURce<[1]]2>:BB:W3GPP:MSTation<2 3 4>:CMODE:PATTern<[1]]2>:TGPL	1(0) ... 100 frames		
[SOURce<[1]]2>:BB:W3GPP:MSTation<2 3 4>:CMODE:PATTern<[1]]2>:TGSN	Slot 0 ... slot 14		
[SOURce<[1]]2>:BB:W3GPP:MSTation<2 3 4>:CMODE:POFFset	0 dB ... 10 dB		

Command	Parameters	Default unit	Comments
[SOURce<[1] 2>:]BB:W3GPP:MSTation<2 3 4>:CMODE:POMode	AUTO   USER		
[SOURce<[1] 2>:]BB:W3GPP:MSTation<2 3 4>:CMODE:STATe	ON   OFF		
[SOURce<[1] 2>:]BB:W3GPP:MSTation<[1] 2 3 4>:DPDCh:FCIO	ON   OFF		
[SOURce<[1] 2>:]BB:W3GPP:MSTation<[1] 2 3 4>:DPDCh:ORATe	D15K   D30K   D60K   D120K   D240K   D480K   D960K   D1920K   D2880K   D3840K   D4800K   D5760K		
[SOURce<[1] 2>:]BB:W3GPP:MSTation<[1] 2 3 4>:DPDCh:POWer	-80dB ... 0 dB	dB	
[SOURce<[1] 2>:]BB:W3GPP:MSTation<[1] 2 3 4>:DPDCh:STATe	ON   OFF		
[SOURce<[1] 2>:]BB:W3GPP:MSTation<[1] 2 3 4>:DPCCh:CCODE			Query only
[SOURce<[1] 2>:]BB:W3GPP:MSTation<[1] 2 3 4>:DPCCh:FBI:MODE	OFF   D1B   D2B		
[SOURce<[1] 2>:]BB:W3GPP:MSTation<[1] 2 3 4>:DPCCh:FBI:PATtern	#B0,1...B11..1, 32		
[SOURce<[1] 2>:]BB:W3GPP:MSTation<[1] 2 3 4>:DPCCh:HS:CCODE			Query only
[SOURce<[1] 2>:]BB:W3GPP:MSTation<[1] 2 3 4>:DPCCh:HS:CQI:PLENght	1 ... 10		
[SOURce<[1] 2>:]BB:W3GPP:MSTation<[1] 2 3 4>:DPCCh:HS:CQI<n>[:VALues]	-1 ... 30		
[SOURce<[1] 2>:]BB:W3GPP:MSTation<[1] 2 3 4>:DPCCh:HS:HAPattern	<string>		
[SOURce<[1] 2>:]BB:W3GPP:MSTation<[1] 2 3 4>:DPCCh:HS:POAC	-10dB..10dB	dB	
[SOURce<[1] 2>:]BB:W3GPP:MSTation<[1] 2 3 4>:DPCCh:HS:PONA	-10dB..10dB	dB	
[SOURce<[1] 2>:]BB:W3GPP:MSTation<[1] 2 3 4>:DPCCh:HS:POWer	-80dB ... 0dB	dB	
[SOURce<[1] 2>:]BB:W3GPP:MSTation<[1] 2 3 4>:DPCCh:HS:SDElay	0 ... 250		
[SOURce<[1] 2>:]BB:W3GPP:MSTation<[1] 2 3 4>:DPCCh:HS:STATe	ON   OFF		
[SOURce<[1] 2>:]BB:W3GPP:MSTation<[1] 2 3 4>:DPCCh:HS:TTIDistance	1 ... 16		
[SOURce<[1] 2>:]BB:W3GPP:MSTation<[1] 2 3 4>:DPCCh:POWer	-80dB ... 0dB	dB	
[SOURce<[1] 2>:]BB:W3GPP:MSTation<[1] 2 3 4>:DPCCh:SFORmat	0 ... 5		
[SOURce<[1] 2>:]BB:W3GPP:MSTation<[1] 2 3 4>:DPCCh:TFCI	0 ... 1023		
[SOURce<[1] 2>:]BB:W3GPP:MSTation<[1] 2 3 4>:DPCCh:TFCI:STATe	ON   OFF		
[SOURce<[1] 2>:]BB:W3GPP:MSTation<[1] 2 3 4>:DPCCh:TOFFset?			Query only
[SOURce<[1] 2>:]BB:W3GPP:MSTation<[1] 2 3 4>:DPCCh:TPC:DATA	ZERO   ONE   DLISt   PATtern		
[SOURce<[1] 2>:]BB:W3GPP:MSTation<[1] 2 3 4>:DPCCh:TPC:DATA:DSElect	<data_list>		
[SOURce<[1] 2>:]BB:W3GPP:MSTation<[1] 2 3 4>:DPCCh:TPC:DATA:PATtern	#B0,1...B11..1, 64		
[SOURce<[1] 2>:]BB:W3GPP:MSTation<[1] 2 3 4>:DPCCh:TPC:MISuse	ON   OFF		
[SOURce<[1] 2>:]BB:W3GPP:MSTation<[1] 2 3 4>:DPCCh:TPC:PSTep	-10dB ... 10dB	dB	
[SOURce<[1] 2>:]BB:W3GPP:MSTation<[1] 2 3 4>:DPCCh:TPC:READ	CONTInuous   S0A   S1A   S01A   S10A		
[SOURce<[1] 2>:]BB:W3GPP:MSTation<[1] 2 3 4>:HSUPa:DPCCh:E:STATe	ON   OFF		
[SOURce<[1] 2>:]BB:W3GPP:MSTation<[1] 2 3 4>:HSUPa:DPCCh:E:DTX:PATtern	<string>		
[SOURce<[1] 2>:]BB:W3GPP:MSTation<[1] 2 3 4>:HSUPa:DPCCh:E:DTX:STATe	ON   OFF		
[SOURce<[1] 2>:]BB:W3GPP:MSTation<[1] 2 3 4>:HSUPa:DPCCh:E:HBIT	ON   OFF		
[SOURce<[1] 2>:]BB:W3GPP:MSTation<[1] 2 3 4>:HSUPa:DPCCh:E:POWer	-80dB ... 0 dB	dB	

Command	Parameters	Default unit	Comments
[SOURCE<[1]>:]BB:W3GPp:MSTation<[1]> 2 3 4>:HSUPa:DPCCh:E:RSNumber	0...3		
[SOURCE<[1]>:]BB:W3GPp:MSTation<[1]> 2 3 4>:HSUPa:DPCCh:E:TFCI	0...127		
[SOURCE<[1]>:]BB:W3GPp:MSTation<[1]> 2 3 4>:HSUPa:DPCCh:E:TTIEdch	2   10	ms	
[SOURCE<[1]>:]BB:W3GPp:MSTation<[1]> 2 3 4>:HSUPa:DPCCh:E:FRC:CHANnel	1...7		
[SOURCE<[1]>:]BB:W3GPp:MSTation<[1]> 2 3 4>:HSUPa:DPCCh:E:FRC:CRATe			Query only
[SOURCE<[1]>:]BB:W3GPp:MSTation<[1]> 2 3 4>:HSUPa:DPCCh:E:FRC:DERRor:BIT:LAYer	TRANsport   PHYSical		
[SOURCE<[1]>:]BB:W3GPp:MSTation<[1]> 2 3 4>:HSUPa:DPCCh:E:FRC:DERRor:BIT:RATE	10E-1...10E-7		
[SOURCE<[1]>:]BB:W3GPp:MSTation<[1]> 2 3 4>:HSUPa:DPCCh:E:FRC:DERRor:BIT:STATe	ON   OFF		
[SOURCE<[1]>:]BB:W3GPp:MSTation<[1]> 2 3 4>:HSUPa:DPCCh:E:FRC:DERRor:BLOCK:RATE	10E-1...10E-4		
[SOURCE<[1]>:]BB:W3GPp:MSTation<[1]> 2 3 4>:HSUPa:DPCCh:E:FRC:DERRor:BLOCK:STATe	ON   OFF		
[SOURCE<[1]>:]BB:W3GPp:MSTation<[1]> 2 3 4>:HSUPa:DPCCh:E:FRC:DTX:PATTern	<string>		
[SOURCE<[1]>:]BB:W3GPp:MSTation<[1]> 2 3 4>:HSUPa:DPCCh:E:FRC:DTX:STATe	ON   OFF		
[SOURCE<[1]>:]BB:W3GPp:MSTation<[1]> 2 3 4>:HSUPa:DPCCh:E:FRC:HARQ:PATTern	<string>		
[SOURCE<[1]>:]BB:W3GPp:MSTation<[1]> 2 3 4>:HSUPa:DPCCh:E:FRC:HARQ:STATe	ON   OFF		
[SOURCE<[1]>:]BB:W3GPp:MSTation<[1]> 2 3 4>:HSUPa:DPCCh:E:FRC:HPROcesses			Query only
[SOURCE<[1]>:]BB:W3GPp:MSTation<[1]> 2 3 4>:HSUPa:DPCCh:E:FRC:MIBRate			Query only
[SOURCE<[1]>:]BB:W3GPp:MSTation<[1]> 2 3 4>:HSUPa:DPCCh:E:FRC:PAYBits			Query only
[SOURCE<[1]>:]BB:W3GPp:MSTation<[1]> 2 3 4>:HSUPa:DPCCh:E:FRC:PCCodes			Query only
[SOURCE<[1]>:]BB:W3GPp:MSTation<[1]> 2 3 4>:HSUPa:DPCCh:E:FRC:STATe	ON   OFF		
[SOURCE<[1]>:]BB:W3GPp:MSTation<[1]> 2 3 4>:HSUPa:DPCCh:E:FRC:TTIBits			Query only
[SOURCE<[1]>:]BB:W3GPp:MSTation<[1]> 2 3 4>:HSUPa:DPCCh:E:FRC:TTIEdch			Query only
[SOURCE<[1]>:]BB:W3GPp:MSTation<[1]> 2 3 4>:HSUPa:CHANnel<[1]...4>:DPDCh:E:CCODE			Query only
[SOURCE<[1]>:]BB:W3GPp:MSTation<[1]> 2 3 4>:HSUPa:CHANnel<[1]...4>:DPDCh:E:DATA	PN9   PN11   PN15   PN16   PN16l   PN20   PN21   PN23   ZERO   ONE   PATTern   DLISt		
[SOURCE<[1]>:]BB:W3GPp:MSTation<[1]> 2 3 4>:HSUPa:CHANnel<[1]...4>:DPDCh:E:DATA:DSElect	<data list>		
[SOURCE<[1]>:]BB:W3GPp:MSTation<[1]> 2 3 4>:HSUPa:CHANnel<[1]...4>:DPDCh:E:DATA:PATTern	#B0,1...B11..1, 32		
[SOURCE<[1]>:]BB:W3GPp:MSTation<[1]> 2 3 4>:HSUPa:DPDCh:E:DTX:PATTern	#B0,1...B11..1, 32		
[SOURCE<[1]>:]BB:W3GPp:MSTation<[1]> 2 3 4>:HSUPa:DPDCh:E:DTX:STATe	ON   OFF		
[SOURCE<[1]>:]BB:W3GPp:MSTation<[1]> 2 3 4>:HSUPa:DPDCh:E:FCIO	ON   OFF		

Command	Parameters	Default unit	Comments
[SOURce<[1]>:]BB:W3Gpp:MSTation<[1]> 2 3 4>:HSUPa:DPDCh:E:ORATe	D60K   D120K   D240K   D480K   D960K   D1920K   D2x1920K   D2x960K2x1920K		
[SOURce<[1]>:]BB:W3Gpp:MSTation<[1]> 2 3 4>:HSUPa:DPDCh:E:POWer	-80dB ... 0 dB		
[SOURce<[1]>:]BB:W3Gpp:MSTation<[1]> 2 3 4>:HSUPa:CHANnel<[1]...4>:DPDCh:E:SRATe			Query only
[SOURce<[1]>:]BB:W3Gpp:MSTation<[1]> 2 3 4>:HSUPa:DPDCh:E:STATe	ON   OFF		
[SOURce<[1]>:]BB:W3Gpp:MSTation<[1]> 2 3 4>:HSUPa:DPDCh:E:TTIEdch	2   10	ms	
[SOURce<[1]>:]BB:W3Gpp:MSTation<[1]> 2 3 4>:MODE	PRACH   PCPCh   DPCDch		
[SOURce<[1]>:]BB:W3Gpp:MSTation<[1]> 2 3 4>:PCPCh:CPOWer	-80dB ... 0 dB	dB	
[SOURce<[1]>:]BB:W3Gpp:MSTation<[1]> 2 3 4>:PCPCh:CPSFormat	0   1   2		
[SOURce<[1]>:]BB:W3Gpp:MSTation<[1]> 2 3 4>:PCPCh:DATA	PN9   PN15   PN16   PN20   PN21   PN23   ZERO   ONE   PATtern		
[SOURce<[1]>:]BB:W3Gpp:MSTation<[1]> 2 3 4>:PCPCh:DATA:DSElect	<data_list>		
[SOURce<[1]>:]BB:W3Gpp:MSTation<[1]> 2 3 4>:PCPCh:DATA:PATtern	#B0,1...B11..1, 64		
[SOURce<[1]>:]BB:W3Gpp:MSTation<[1]> 2 3 4>:PCPCh:DPOWer	-80 dB ... 0dB	dB	
[SOURce<[1]>:]BB:W3Gpp:MSTation<[1]> 2 3 4>:PCPCh:FBI:MODE	OFF   D1B   D2B		
[SOURce<[1]>:]BB:W3Gpp:MSTation<[1]> 2 3 4>:PCPCh:FBI:PATtern	#B0,1...B11..1, 32		
[SOURce<[1]>:]BB:W3Gpp:MSTation<[1]> 2 3 4>:PCPCh:MLENght	1   2		
[SOURce<[1]>:]BB:W3Gpp:MSTation<[1]> 2 3 4>:PCPCh:PLENght	S0   S8		
[SOURce<[1]>:]BB:W3Gpp:MSTation<[1]> 2 3 4>:PCPCh:PPOWer	-80dB ... 0dB	dB	
[SOURce<[1]>:]BB:W3Gpp:MSTation<[1]> 2 3 4>:PCPCh:PPOWer:STEP	0dB ... +10dB	dB	
[SOURce<[1]>:]BB:W3Gpp:MSTation<[1]> 2 3 4>:PCPCh:PREPetition	1...10		
[SOURce<[1]>:]BB:W3Gpp:MSTation<[1]> 2 3 4>:PCPCh:SIGNature	0...15		
[SOURce<[1]>:]BB:W3Gpp:MSTation<[1]> 2 3 4>:PCPCh:SRATe	D15K   D30K   D60K   D120K   D240K   D480K   D960K		
[SOURce<[1]>:]BB:W3Gpp:MSTation<[1]> 2 3 4>:PCPCh:TFCI	0...1023		
[SOURce<[1]>:]BB:W3Gpp:MSTation<[1]> 2 3 4>:PCPCh:TIMing:DPOWer:MPARt?			Query only
[SOURce<[1]>:]BB:W3Gpp:MSTation<[1]> 2 3 4>:PCPCh:TIMing:DPOWer:PREAmble?			Query only
[SOURce<[1]>:]BB:W3Gpp:MSTation<[1]> 2 3 4>:PCPCh:TIMing:SOFFset	0 ... 14		
[SOURce<[1]>:]BB:W3Gpp:MSTation<[1]> 2 3 4>:PCPCh:TIMing:SPERiod?			Query only
[SOURce<[1]>:]BB:W3Gpp:MSTation<[1]> 2 3 4>:PCPCh:TIMing:TIME:PREMp	0 ... 14		
[SOURce<[1]>:]BB:W3Gpp:MSTation<[1]> 2 3 4>:PCPCh:TIMing:TIME:PREPre	0 ... 14		

Command	Parameters	Default unit	Comments
[SOURCE<[1]>:]BB:W3GPP:MSTation<[1]> 2 3 4>:PCPCh:TPC:DATA	PN9   PN15   PN16   PN20   PN21   PN23   ZERO   ONE   PATTErn		
[SOURCE<[1]>:]BB:W3GPP:MSTation<[1]> 2 3 4>:PCPCh:TPC:DATA:DSElect	<data_list>		
[SOURCE<[1]>:]BB:W3GPP:MSTation<[1]> 2 3 4>:PCPCh:TPC:DATA:PATTErn	#B0,1...B11..1, 64		
[SOURCE<[1]>:]BB:W3GPP:MSTation<[1]> 2 3 4>:PCPCh:TPC:READ	CONTInuous   S0A   S1A   S01A   S10A		
[SOURCE<[1]>:]BB:W3GPP:MSTation<[1]> 2 3 4>:PRACH:CPOWER	-80dB ... 0dB	dB	
[SOURCE<[1]>:]BB:W3GPP:MSTation<[1]> 2 3 4>:PRACH:DATA	PN9   PN15   PN16   PN20   PN21   PN23   ZERO   ONE   PATTErn		
[SOURCE<[1]>:]BB:W3GPP:MSTation<[1]> 2 3 4>:PRACH:DATA:DSElect	<data_list>		
[SOURCE<[1]>:]BB:W3GPP:MSTation<[1]> 2 3 4>:PRACH:DATA:PATTErn	#B0,1...B11..1, 64		
[SOURCE<[1]>:]BB:W3GPP:MSTation<[1]> 2 3 4>:PRACH:DPOWER	-80dB ... 0 dB	dB	
[SOURCE<[1]>:]BB:W3GPP:MSTation<[1]> 2 3 4>:PRACH:MLENgtH	1   2		
[SOURCE<[1]>:]BB:W3GPP:MSTation<[1]> 2 3 4>:PRACH:PPOWER	-80dB ... 0 dB	dB	
[SOURCE<[1]>:]BB:W3GPP:MSTation<[1]> 2 3 4>:PRACH:PPOWER:STEP	-80dB ... 0 dB	dB	
[SOURCE<[1]>:]BB:W3GPP:MSTation<[1]> 2 3 4>:PRACH:PREPetition	1...10		
[SOURCE<[1]>:]BB:W3GPP:MSTation<[1]> 2 3 4>:PRACH:SFORmat	0 ... 3		
[SOURCE<[1]>:]BB:W3GPP:MSTation<[1]> 2 3 4>:PRACH:SIGNature	0...15		
[SOURCE<[1]>:]BB:W3GPP:MSTation<[1]> 2 3 4>:PRACH:SRATe	D15K   D30K   D60K   D120K   D240K   D480K   D960K		
[SOURCE<[1]>:]BB:W3GPP:MSTation<[1]> 2 3 4>:PRACH:TFCI	0...1023		
[SOURCE<[1]>:]BB:W3GPP:MSTation<[1]> 2 3 4>:PRACH:TIMing:DPOWER:MPARt?			Query only
[SOURCE<[1]>:]BB:W3GPP:MSTation<[1]> 2 3 4>:PRACH:TIMing:DPOWER:MPARt:CONTRol?			Query only
[SOURCE<[1]>:]BB:W3GPP:MSTation<[1]> 2 3 4>:PRACH:TIMing:DPOWER:MPARt:DATA?			Query only
[SOURCE<[1]>:]BB:W3GPP:MSTation<[1]> 2 3 4>:PRACH:TIMing:DPOWER:PREamble?			Query only
[SOURCE<[1]>:]BB:W3GPP:MSTation<[1]> 2 3 4>:PRACH:TIMing:SOFFset	0 ... 14		
[SOURCE<[1]>:]BB:W3GPP:MSTation<[1]> 2 3 4>:PRACH:TIMing:SPERiod?			Query only
[SOURCE<[1]>:]BB:W3GPP:MSTation<[1]> 2 3 4>:PRACH:TIMing:TIME:PREMp	0 ...14		
[SOURCE<[1]>:]BB:W3GPP:MSTation<[1]> 2 3 4>:PRACH:TIMing:TIME:PREPre	0 ...14		
[SOURCE<[1]>:]BB:W3GPP:MSTation:PRESet			No query
[SOURCE<[1]>:]BB:W3GPP:MSTation<[1]> 2 3 4>:SCODE	#H0...#HFFFF FF		
[SOURCE<[1]>:]BB:W3GPP:MSTation<[1]> 2 3 4>:SCODE:MODE	LONG   SHORT   OFF		
[SOURCE<[1]>:]BB:W3GPP:MSTation<[1]> 2 3 4>:STATE	ON   OFF		
[SOURCE<[1]>:]BB:W3GPP:MSTation<2 3 4>:TDELay	0 ... 38400 chips		

[SOURce<[1]2>:]BB:W3GPP:MSTation:ADDITIONAL:COUNT 1 ... 128

The command sets the number of additional user equipment.

The R&S Vector Signal Generator gives you the opportunity to simulate up to 128 additional user equipment - corresponding to a receive signal for a base station with high capacity utilization. The fourth user equipment (UE4) serves as a template for all other stations. The only parameters of the additional user equipment to be modified are the scrambling code and the power.

**Example:**           "BB:W3GP:MST:ADD:COUN 20"  
                          'sets 20 additional user equipment.

                          "BB:W3GP:MST:ADD:POW:OFFS -3.0"  
                          'sets the power offset to -3 dB.

                          "BB:W3GP:MST:ADD:SCOD:STEP 1"  
                          'sets the step width for increasing the scrambling code to 1.

                          "BB:W3GP:MST:ADD:STAT ON"  
                          'connects the 20 user equipment to the 3GPP FDD signal.

*RST value	Resolution	Options	SCPI
4	-	B10/B11 and B13 K42 SOURce2 only with second option B9/B10/B11	Device-specific

[SOURce<[1]2>:]BB:W3GPP:MSTation:ADDITIONAL:POWER:OFFSet -80 dB... 0 dB

The command sets the power offset of the active channels of the additional user equipment relative to the power of the active channels of the reference station UE4.

The offset applies to all the additional user equipment. The resultant overall power must fall within the range 0 ... - 80 dB. If the value is above or below this range, it is limited automatically.

**Example:**           "BB:W3GP:MST:ADD:POW:OFFS -3.0"  
                          'sets the offset to -3 dB.

*RST value	Resolution	Options	SCPI
0 dB	0.1 dB	B10/B11 and B13 K42 SOURce2 only with second option B9/B10/B11	Device-specific

[SOURce<[1]2>:]BB:W3GPP:MSTation:ADDITIONAL:SCODE:STEP #H1 ... #HFFFF FF

The command sets the step width for increasing the scrambling code of the additional user equipment. The start value is the scrambling code of UE4.

**Example:**           "BB:W3GP:MST:ADD:SCOD:STEP #H55"  
                          'sets the step width for increasing the scrambling code to #H55.

*RST value	Resolution	Options	SCPI
#H1		B10/B11 and B13 K42 SOURce2 only with second option B9/B10/B11	Device-specific

[SOURce<[1]|2>:]BB:W3GPP:MSTation:ADDITIONal:STATe ON | OFF

The command activates additional user equipment.

The suffix at MSTation has no significance for this command and should not be specified.

**Example:** "BB:W3GP:MST:ADD:STAT ON"  
 'connects the additional user equipment to the 3GPP FDD signal.

*RST value	Resolution	Options	SCPI
OFF		B10/B11 and B13 K42 SOURce2 only with second option B9/B10/B11	Device-specific

[SOURce<[1]|2>:]BB:W3GPP:MSTation:ADDITIONal:TDELay:STEP 0 ... 38400 chips

The command sets the step width for the time delay of the additional user equipment to one another. The start value returns the time delay of UE4. Entry is made in chips and can be a maximum of 1 frame.

**Example:** "BB:W3GP:MST:ADD:TDEL:STEP 256"  
 'shifts each of the user equipment 256 chips apart, starting from the time delay of UE4.

*RST value	Resolution	Options	SCPI
0 chip	1 chip	B10/B11 and B13 K42 SOURce2 only with second option B9/B10/B11	Device-specific

[SOURce<[1]|2>:]BB:W3GPP:MSTation<[1]|2|3|4>:CHANnel<[1]...6>:DPDCh:CCODE?

The command queries the channelization code of the specified channel. The value is fixed and depends on the overall symbol rate of the user equipment (see the table with the channel table description in Chapter 4).

The command is a query command and therefore does not have an \*RST value.

**Example:** "BB:W3GP:MST1:CHAN:DPDC:CCOD?"  
 'queries the channelization code for DPDCH 1 of user equipment 1.

*RST value	Resolution	Options	SCPI
-	-	B10/B11 and B13 K42 SOURce2 only with second option B9/B10/B11	Device-specific

**[SOURce<[1]|2>:]BB:W3Gpp:MSTation<[1]|2|3|4>:CHANnel<[1]...6>:DPDCh:DATA**  
 PN9 | PN15 | PN16 | PN20 | PN21 | PN23 | DLISt | ZERO | ONE | PATTErn

The command determines the data source for the selected DPDCH.

For the enhanced channels of user equipment 1 (UE1), this entry is valid when channel coding is deactivated. When channel coding is active, data sources are selected for the transport channels with the commands :BB:W3Gpp:MST:CHANnel:DPDCh:DCCH:DATA and :BB:W3Gpp:MST:ENHanced:TCHannel:DATA.

**Parameters:**      **PNxx**  
 The pseudo-random sequence generator is used as the data source. Different random sequence lengths can be selected.

**DLISt**  
 A data list is used. The data list is selected with the command :BB:W3Gpp:MST:CHANnel:DPDCh:DATA:DSElect.

**ZERO | ONE**  
 Internal 0 and 1 data is used.

**PATTErn**  
 Internal data is used. The bit pattern for the data is defined by the command SOURce:BB:W3Gpp:CHANnel:DPDCh:DATA:PATTErn

**Example:**      "BB:W3GP:MST1:CHAN:DPDC:DATA PN11"  
 'selects internal PRBS data with period length  $2^{11}-1$  as the data source.

*RST value	Resolution	Options	SCPI
PN9	-	B10/B11 and B13 K42 SOURce2 only with second option B9/B10/B11	Device-specific

**[SOURce<[1]|2>:]BB:W3Gpp:MSTation<[1]|2|3|4>:CHANnel<[1]...6>:DPDCh:DATA:DSElect**  
 <data list name>

The command selects the data list for the DLISt data source selection.

The files are stored with the fixed file extensions \*.dm\_iqd in a directory of the user's choice. The directory applicable to the commands is defined with the command MMEMoRY:CDIR. To access the files in this directory, you only have to give the file name, without the path and the file extension.

**Example:**      "BB:W3GP:MST1:CHAN1:DPDC:DATA DLIS"  
 'selects the Data Lists data source.  
 "MMEM:CDIR 'D:\Lists\Dm\IQData'"  
 'selects the directory for the data lists.  
 "BB:W3GP:MST1:CHAN1:DPDC:DATA:DSEL 'dpdch\_13'"  
 'selects the file 'dpdch\_13' as the data source.

*RST value	Resolution	Options	SCPI
-	-	B10/B11 and B13 K42 SOURce2 only with second option B9/B10/B11	Device-specific



[SOURce<[1]|2>:]BB:W3GPp:MSTation<[1]|2|3|4>:CHANnel<[1]...6>:DPDCh:DATA:PATtern  
#B0,1...'B11..1,64

The command enters the bit pattern for the PATtern data source selection. The first parameter determines the bit pattern (choice of hexadecimal, octal or binary notation), the second specifies the number of bits to use.

**Example:** "BB:W3GP:MST1:CHAN1:DPDC:DATA PATT"  
'selects the Pattern data source.  
"BB:W3GP:MST1:CHAN1:DPDC:DATA:PATT #H3F, 8"  
'defines the bit pattern.

*RST value	Resolution	Options	SCPI
#H0,1	-	B10/B11 and B13 K42 SOURce2 only with second option B9/B10/B11	Device-specific

[SOURce<[1]|2>:]BB:W3GPp:MSTation<[1]|2|3|4>:CHANnel<[1]...6>:DPDCh:DATA:DCCH  
PN9 | PN15 | PN16 | PN20 | PN21 | PN23 | DLISt | ZERO | ONE | PATtern

The command determines the data source for the DCCH.

This command is only available for UE1 in the enhanced state (realtime signal generation) when channel coding is active. It is also possible to set the data source for the DCCH with the command :BB:W3GPp:MSTation:ENHanced:TCHannel1:DATA.

**Parameters:** **PNxx**  
The pseudo-random sequence generator is used as the data source. Different random sequence lengths can be selected.

**DLISt**  
The internal data generator is used.

**ZERO | ONE**  
Internal 0 and 1 data is used.

**PATtern**  
Internal data is used. The bit pattern for the data is defined by the command SOURce:BB:W3GPp:CHANnel:DPDCh:DCCH:DATA:PATtern.

**Example:** "BB:W3GP:MST1:CHAN1:DPDC:DATA:DCCH PN11"  
'selects internal PRBS data with period length  $2^{11}-1$  as the data source.

*RST value	Resolution	Options	Dependencies	SCPI
PN9	-	B10/B11 and B13 K42 SOURce2 only with second option B9/B10/B11	This command and the command :BB:W3GPp:MST:ENHanced:TCHannel:DATA convert each other to the entered value.	Device-specific

[SOURce<[1]|2>:]BB:W3GPP:MSTation<[1]|2|3|4>:CHANnel<[1]...6>:DPDCh:DATA:DCCH:DSElect <data list name>

The command selects the data list for the DLIS data source selection.

The files are stored with the fixed file extensions \*.dm\_iqd in a directory of the user's choice. The directory applicable to the commands is defined with the command MMEMoRY:CDIR. To access the files in this directory, you only have to give the file name, without the path and the file extension.

This command is only available for UE1 in the enhanced state (realtime signal generation) when channel coding is active. It is also possible to select a data list for the DCCH with the command :BB:W3GPP:MSTation:ENHanced:TCHannell:DATA:DSElect.

```

Example:      "BB:W3GP:MST1:CHAN1:DPDC:DATA:DCCH DLIS"
                  'selects the Data Lists data source.

                  "MMEM:CDIR 'D:\Lists\Dm\IQData'"
                  'selects the directory for the data lists.

                  "BB:W3GP:MST1:CHAN1:DPDC:DATA:DCCH:DSEL 'dpdch_13'"
                  'selects the file 'dpdch_13' as the data source.
    
```

*RST value	Resolution	Options	Dependencies	SCPI
-	-	B10/B11 and B13 K42 SOURce2 only with second option B9/B10/B11	This command and the command :BB:W3GPP:MST:ENHanced:TCHannell:DATA:DSEL each select the valid data list	Device-specific

[SOURce<[1]|2>:]BB:W3GPP:MSTation<[1]|2|3|4>:CHANnel<[1]...6>:DPDCh:DATA:DCCH:PATtern #B0,1...B11..1,64

The command enters the bit pattern for the PATtern data source selection. The first parameter determines the bit pattern (choice of hexadecimal, octal or binary notation), the second specifies the number of bits to use.

This command is only available for UE1 in the enhanced state (realtime signal generation) when channel coding is active. It is also possible to select a data list for the DCCH with the command :BB:W3GPP:MSTation:ENHanced:TCHannell:DATA:PATtern.

```

Example:      "BB:W3GP:MST1:CHAN1:DPDC:DATA:DCCH PATT"
                  'selects the Pattern data source.

                  "BB:W3GP:MST1:CHAN1:DPDC:DATA:DCCH:PATT #H3F,8"
                  'defines the bit pattern.
    
```

*RST value	Resolution	Options	Dependencies	SCPI
#H0,1	-	B10/B11 and B13 K42 SOURce2 only with second option B9/B10/B11	This command and the command :BB:W3GPP:MST:ENHanced:TCHannell:DATA:PATtern each overwrite the pattern that was entered by the other command.	Device-specific

**[SOURce<[1]|2>:]BB:W3GPP:MSTation<[1]|2|3|4>:CHANnel<[1]...6>:DPDCh:SRATe?**

The command queries the symbol rate of the DPDCH. The symbol rate depends on the overall symbol rate set and cannot be modified (see also the channel table in Chapter 4).

The command is a query command and therefore does not have an \*RST value.

**Example:** "BB:W3GP:MST4:CHAN2:DPDC:SRAT?"  
'queries the symbol rate of DPDCH 2 of user equipment 4.

Response: "960"  
'the symbol rate is 960 ksp/s.

**Note:**  
*DPDCH 2 is only active once the overall symbol rate is 2 x 960 ksp/s or more. When overall symbol rates are less, the error message "???" is returned.*

*RST value	Resolution	Options	SCPI
-	-	B10/B11 and B13 K42 SOURce2 only with second option B9/B10/B11	Device-specific

**[SOURce<[1]|2>:]BB:W3GPP:MSTation<2|3|4>:CMODE:METHOD HLSCheduling | SF2**

The command selects compressed mode method

Compressed Mode can be configured for user equipment 2, 3 and 4.

**Parameters:** **SF2**  
The data is compressed by halving the spreading factor.

**HLSCheduling**  
The data is compressed by stopping the transmission of the data stream during the transmission gap.

**Example:** "BB:W3GP:MST2:CMOD:METH HLSC"  
'selects compressed mode method High Layer Scheduling

*RST value	Resolution	Options	SCPI
SF2	-	B10/B11 and B13 K42 SOURce2 only with second option B9/B10/B11	Device-specific

**[SOURce<[1]|2>:]BB:W3GPP:MSTation<2|3|4>:CMODE:PATTern<[1]|2>:TGD 3...100 slots**

The command sets the transmission gap distances. .

Compressed Mode can be configured for user equipment 2, 3 and 4.

**Example:** "BB:W3GP:MST2:CMOD:PATT2:TGD 7"  
'sets transmission gap distance of pattern 2 to 7 slots.

*RST value	Resolution	Options	Dependencies	SCPI
15 slots	-	B10/B11 and B13 K42 SOURce2 only with second option B9/B10/B11	The transmission gap distances of the base station with the same suffix as the selected user equipment is set to the same value	Device-specific

[SOURce<[1]>:]BB:W3Gpp:MSTation<2|3|4>:CMODE:PATtern<[1]>:TGL<[1]> 3...14 slots

The command sets the transmission gap lengths.

Compressed Mode can be configured for user equipment 2, 3 and 4.

**Example:** "BB:W3GP:MST2:CMOD:PATT2:TGL1 4  
'sets transmission gap length of gap 1 of pattern 2 to 4 slots.

*RST value	Resolution	Options	Dependencies	SCPI
3 slots	-	B10/B11 and B13 K42 SOURce2 only with second option B9/B10/B11	The transmission gap lengths of the base station with the same suffix as the selected user equipment is set to the same value.	Device-specific

[SOURce<[1]>:]BB:W3Gpp:MSTation<2|3|4>:CMODE:PATtern<[1]>:TGPL 1/0...100 frames

The command sets the transmission gap pattern lengths. Setting 0 is available only for pattern 2.

Compressed Mode can be configured for user equipment 2, 3 and 4.

**Example:** "BB:W3GP:MST2:CMOD:PATT2:TGPL 7  
'sets transmission gap pattern length of pattern 2 to 7 frames.

*RST value	Resolution	Options	Dependencies	SCPI
2 frames	-	B10/B11 and B13 K42 Compressed Mode Pattern Length - UE	The transmission gap pattern lengths of the base station with the same suffix as the selected user equipment is set to the same value.	Device-specific

[SOURce<[1]>:]BB:W3Gpp:MSTation<2|3|4>:CMODE:PATtern<[1]>:TGSN slot 0...slot 14

The command sets the transmission gap slot number of pattern 1. Slot number of pattern 2 is automatically set to the same value as slot number of pattern 1.

Compressed Mode can be configured for user equipment 2, 3 and 4.

**Example:** "BB:W3GP:MST2:CMOD:PATT:TGSN 4  
'sets slot number of pattern 1 to slot 4.

*RST value	Resolution	Options	Dependencies	SCPI
Slot 7	-	B10/B11 and B13 K42 SOURce2 only with second option B9/B10/B11	The transmission gap slot number of the base station with the same suffix as the selected user equipment is set to the same value.	Device-specific

[SOURce<[1]|2>:]BB:W3GPp:MSTation<2|3|4>:CMODE:POMode AUTO | USER

The command selects the power offset mode.

Compressed Mode can be configured for user equipment 2, 3 and 4.

**Parameters: AUTO**

The power offset is obtained by pilot bit ratio as follows:  
 Number of pilots bits of non-compressed slots/Number of pilot bits by compressed slots.

**USER**

The power offset is defined by command  
 :BB:W3GP:MSTation<2|3|4>CMODE:POFFset

**Example:** "BB:W3GP:MST2:CMOD:POFF 4"  
 'sets the power offset value to 4 dB.

"BB:W3GP:MST2:CMOD:POM USER"  
 'selects power offset mode USER, the power offset is set to 4 dB.

*RST value	Resolution	Options	SCPI
AUTO	-	B10/B11 and B13 K42 SOURce2 only with second option B9/B10/B11	Device-specific

[SOURce<[1]|2>:]BB:W3GPp:MSTation<2|3|4>:CMODE:POFFset 0 dB...10 dB

The command sets the power offset for mode USER.

Compressed Mode can be configured for user equipment 2, 3 and 4.

**Example:** "BB:W3GP:MST2:CMOD:POFF 4"  
 'sets the power offset value to 4 dB.

"BB:W3GP:MST2:CMOD:POM USER"  
 'selects power offset mode USER, the power offset is set to 4 dB.

*RST value	Resolution	Options	SCPI
0 dB	0.01 dB	B10/B11 and B13 K42 SOURce2 only with second option B9/B10/B11	Device-specific

[SOURce<[1]|2>:]BB:W3GPp:MSTation<2|3|4>:CMODE:STATe ON | OFF

The command activates/deactivates the compressed mode.

Compressed Mode can be activated for user equipment 2, 3 and 4.

**Example:** "BB:W3GP:MST2:CMOD:STAT ON"  
 'activates compressed mode for user equipment 2.

*RST value	Resolution	Options	SCPI
OFF	-	B10/B11 and B13 K42 SOURce2 only with second option B9/B10/B11	Device-specific

[SOURce<[1]|2>:]BB:W3GPP:MSTation<[1]|2|3|4>:DPDCh:FCIO ON | OFF

The command sets the channelization code to I/O. This mode can only be activated if the overall symbol rate is < 2 x 960 kbps.

**Example:** "BB:W3GP:MST1:DPDC:FCIO ON"  
'sets the channelization code to I/O.

*RST value	Resolution	Options	SCPI
OFF	-	B10/B11 and B13 K42 SOURce2 only with second option B9/B10/B11	Device-specific

[SOURce<[1]|2>:]BB:W3GPP:MSTation<[1]|2|3|4>:DPDCh:ORATe

D15K | D30K | D60K | D120K | D240K | D480K | D960K | D1920K | D2880K | D3840K | D4800K | D5760K

The command sets the overall symbol rate. The overall symbol rate determines the number of DPDCHs as well as their symbol rate and channelization codes.

**Parameters:** D15K ... D5760K  
15 ksps ... 6 x 960 ksps

**Example:** "BB:W3GP:MST1:DPDC:ORAT D15K"  
'sets the overall symbol rate to 15 ksps. Only DPDCH1 is active, the symbol rate is 15 ksps and the channelization code is 64.

*RST value	Resolution	Options	SCPI
D60K	-	B10/B11 and B13 K42 SOURce2 only with second option B9/B10/B11	Device-specific

[SOURce<[1]|2>:]BB:W3GPP:MSTation<[1]|2|3|4>:DPDCh:POWer -80 dB ... 0 dB

The command defines the channel power of the DPDCHs. The power entered is relative to the powers of the other channels. If **Adjust Total Power to 0 dB** is executed (:BB:W3GP:POWer:ADJust), the power is normalized to a total power for all channels of 0 dB. The power ratios of the individual channels remains unchanged.

**Note:**

*The uplink channels are not blanked in this mode (duty cycle 100%).*

**Example:** "BB:W3GP:MST4:DPDC:POW -60dB"  
'sets the channel power for DPDCH 2 of user equipment 4 to -60 dB. The channel power relates to the power of the other channels.

"BB:W3GP:POW:ADJ"  
'the channel power relates to 0 dB.

*RST value	Resolution	Options	SCPI
0 dB	0.01 dB	B10/B11 and B13 K42 SOURce2 only with second option B9/B10/B11	Device-specific

[SOURce<[1]|2>:]BB:W3GPp:MSTation<[1]|2|3|4>:DPDCh:STATe ON | OFF

The command activates or deactivates DPDCHs. This always activates or deactivates all the channels. The number of channels (1...6) is determined by the overall symbol rate (see the channel table in Chapter 4).

**Example:** "BB:W3GP:MST1:DPDC:STAT ON"  
'activates all the DPDCHs.

*RST value	Resolution	Options	SCPI
OFF	-	B10/B11 and B13 K42 SOURce2 only with second option B9/B10/B11	Device-specific

[SOURce<[1]|2>:]BB:W3GPp:MSTation<[1]|2|3|4>:DPCCh:CCODE?

The command queries the channelization code and the modulation branch of the specified channel. The value is fixed.

The command is a query command and therefore does not have an \*RST value.

**Example:** "BB:W3GP:MST1:DPCC:CCOD?"  
'queries the channelization code for DPCCH of user equipment 1.

Response: "Q, 64"  
'queries the channelization code for DPCCH of user equipment 1.

*RST value	Resolution	Options	SCPI
-	-	B10/B11 and B13 K42 SOURce2 only with second option B9/B10/B11	Device-specific

[SOURce<[1]|2>:]BB:W3GPp:MSTation<[1]|2|3|4>:DPCCh:FBI:MODE OFF | D1B | D2B

The command sets the number of bits (1 or 2) for the FBI field. With OFF, the FBI field is not used.

**Example:** "BB:W3GP:MST1:DPCC:FBI:MODE OFF"  
'an FBI field is not used.

*RST value	Resolution	Options	Dependency	SCPI
OFF	-	B10/B11 and B13 K42 SOURce2 only with second option B9/B10/B11	The command sets the slot format (BB:W3GP:MST:DPCC:SFOR) in conjunction with the set TFCI status (BB:W3GP:MST1:DPCC:TFCI STAT) to the associated values.	Device-specific

[SOURce<[1]|2>:]BB:W3GPP:MSTation<[1]|2|3|4>:DPCCh:FBI:PATtern #B0,1...B11..1,32

The command determines the bit pattern when the PATtern data source is selected for the FBI field. The maximum length is 32 bits. The first parameter determines the bit pattern (choice of hexadecimal, octal or binary notation), the second specifies the number of bits to use.

**Example:** "BB:W3GP:MST1:DPCC:FBI:PATT #H3F,8"  
'defines the bit pattern of the data for the FBI field.

*RST value	Resolution	Options	SCPI
#H0, 1	-	B10/B11 and B13 K42 SOURce2 only with second option B9/B10/B11	Device-specific

[SOURce<[1]|2>:]BB:W3GPP:MSTation<[1]|2|3|4>:DPCCh:HS:CCODE?

The command queries the channelization code and the modulation branch of the HS-DPCCH.

The command is a query command and therefore does not have an \*RST value.

**Example:** "BB:W3GP:MST1:DPCC:HS:CCOD?"  
'queries the channelization code.

Response: "Q,32"  
'the channelization code is 32 and the modulation branch is Q.

*RST value	Resolution	Options	SCPI
		B10/B11 and B13 K42 SOURce2 only with second option B9/B10/B11	Device-specific

[SOURce<[1]|2>:]BB:W3GPP:MSTation<[1]|2|3|4>:DPCCh:HS:CQI:PLENght 1 ... 10

The command sets the length of the CQI sequence. The values of the CQI sequence are defined with command :SOURce:BB:W3GPP:MST:DPCC:HS:CQI<n>:VALues. The pattern is generated cyclically.

**Example:** "BB:W3GP:MST1:DPCC:HS:CQI:PLEN 2"  
'the CQI sequence length is 2 values.

"BB:W3GP:MST1:DPCC:HS:CQI1 -1"  
'the first CQI value is -1.

"BB:W3GP:MST1:DPCC:HS:CQI2 2"  
'the second CQI value is 2.

*RST value	Resolution	Options	SCPI
1		B10/B11 and B13 K42 SOURce2 only with second option B9/B10/B11	Device-specific



**[SOURce<[1]|2>:]BB:W3GPp:MSTation<[1]|2|3|4>:DPCCh:HS:CQI[:VALues] 1 ... 10**

The command sets the values of the CQI sequence. . Value 1 means that no CQI is sent (DTX - Discontinuous Transmission). The length of the CQI sequence is defined with command : SOURce:BB:W3GPp:MST:DPCCh:HS:CQI:PLENgtH. The pattern is generated cyclically.

**Example:** "BB:W3GP:MST1:DPCC:HS:CQI:PLEN 2"  
'the CQI sequence length is 2 values.  
"BB:W3GP:MST1:DPCC:HS:CQI1 -1"  
'the first CQI value is -1.  
"BB:W3GP:MST1:DPCC:HS:CQI2 2"  
'the second CQI value is 2.

*RST value	Resolution	Options	SCPI
1		B10/B11 and B13 K42 SOURce2 only with second option B9/B10/B11	Device-specific

**[SOURce<[1]|2>:]BB:W3GPp:MSTation<[1]|2|3|4>:DPCCh:HS:HAPattern <string>**

The command enters the pattern for the HARQ-ACK field (Hybrid-ARQ Acknowledgement). The pattern is entered as string, the maximum number of entries is 32. Three different characters are permitted (see below).

**Parameter:** "1"  
The HARQ ACK is sent (ACK). Transmission was successful and correct.  
"0"  
The NACK is not sent (NACK). Transmission was not correct. With an NACK, the UE requests retransmission of the incorrect data.  
"-"  
Nothing is sent. Transmission is interrupted (Discontinuous Transmission (DTX)).

**Example:** "BB:W3GP:MST1:DPCC:HS:HAP "110--110-0"  
'enters the pattern for the HARQ-ACK field.

*RST value	Resolution	Options	SCPI
<empty>		B10/B11 and B13 K42 SOURce2 only with second option B9/B10/B11	Device-specific

**[SOURce<[1]|2>:]BB:W3GPp:MSTation<[1]|2|3|4>:DPCCh:HS:POAC -10dB...10dB**

The command sets the channel power part of the ACK in dB.

**Example:** "BB:W3GP:MST1:DPCC:HS:POAC -2.5dB"  
'sets the channel power part of the ACK to 2.5dB.

*RST value	Resolution	Options	SCPI
0>		B10/B11 and B13 K42 SOURce2 only with second option B9/B10/B11	Device-specific

[SOURce<[1]|2>:]BB:W3GPP:MSTation<[1]|2|3|4>:DPCCh:HS:PONA -10dB...10dB

The command sets the channel power part of the NACK in dB.

**Example:** "BB:W3GP:MST1:DPCC:HS:PONA -2.5dB  
'sets the channel power part of the NACK to 2.5dB.

*RST value	Resolution	Options	SCPI
0>		B10/B11 and B13 K42 SOURce2 only with second option B9/B10/B11	Device-specific

[SOURce<[1]|2>:]BB:W3GPP:MSTation<[1]|2|3|4>:DPCCh:HS:POWER -80.00 ... 0.00 dB

The command sets the channel power in dB. The power entered is relative to the powers of the other channels. If **Adjust Total Power to 0 dB** is executed (:BB:W3GP:POWer:ADJust), the power is normalized to a total power for all channels of 0 dB. The power ratios of the individual channels remains unchanged.

**Note:**  
The uplink high speed channel is blanked (duty cycle 3/15).

**Example:** "BB:W3GP:MST1:DPCC:HS:POW -30"  
'sets the channel power to -30dB.

*RST value	Resolution	Options	SCPI
0 dB	0.00 dB	B10/B11 and B13 K42 SOURce2 only with second option B9/B10/B11	Device-specific

[SOURce<[1]|2>:]BB:W3GPP:MSTation<[1]|2|3|4>:DPCCh:HS:SDElay 0 ... 250

This command sets the delay between the uplink HS-DPCCH and the frame of uplink DPCH. The delay is entered as a multiple *m* of 256 chips according to TS 25.211 7.7

**Example:** "BB:W3GP:MST1:DPCC:HS:SDEL 101"  
'sets a start delay of 101 x 256 chips.

*RST value	Resolution	Options	SCPI
101		B10/B11 and B13 K42 SOURce2 only with second option B9/B10/B11	Device-specific

**[SOURce<[1]|2>:]BB:W3GPp:MSTation<[1]|2|3|4>:DPCCh:HS:STATe ON | OFF**

This command activates or deactivates the HS-DPCCH.

**Example:** "BB:W3GP:MST1:DPCC:HS:STAT ON"  
'activates HS-DPCCH.

*RST value	Resolution	Options	SCPI
OFF		B10/B11 and B13 K42 SOURce2 only with second option B9/B10/B11	Device-specific

**[SOURce<[1]|2>:]BB:W3GPp:MSTation<[1]|2|3|4>:DPCCh:HS:HSDPa:TTIDistance 1 ...16**

The command selects the distance between two packets in HSDPA packet mode. The distance is set in number of sub-frames (3 slots = 2 ms). An **Inter TTI Distance** of 1 means continuous generation.

**Example:** "BB:W3GP:MST1:DPCC:HS:TTID 4"  
'selects an Inter TTI Distance of 4 subframes.

*RST value	Resolution	Options	SCPI
5	-	B10/B11 and B13 K42 SOURce2 only with second option B9/B10/B11	Device-specific

**[SOURce<[1]|2>:]BB:W3GPp:MSTation<[1]|2|3|4>:DPCCh:POWER -80 dB ... 0 dB**

The command defines the channel power for the DPCCH.

**Example:** "BB:W3GP:MST1:DPCC:POW -10 dB"  
'sets the channel power to -10 dB.

*RST value	Resolution	Options	SCPI
0 dB	0.1 dB	B10/B11 and B13 K42 SOURce2 only with second option B9/B10/B11	Device-specific

**[SOURce<[1]|2>:]BB:W3GPp:MSTation<[1]|2|3|4>:DPCCh:SFormat 0 ... 5**

The command sets the slot format for the DPCCH.

**Example:** "BB:W3GP:MST2:DPCC:SFOR 3"  
'selects slot format 3 for the DPCCH of user equipment 2.

*RST value	Resolution	Options	Dependency	SCPI
0	-	B10/B11 and B13 K42 SOURce2 only with second option B9/B10/B11	The command sets the FBI mode (BB:W3GP:MST:DPCC:FBI:MODE) and the TFCI status (BB:W3GP:MST1:DPCC:TFCI:STAT) to the associated values.	Device-specific

[SOURce<[1]>:]BB:W3GPp:MSTation<[1]>|2|3|4>:DPCCh:TFCI 0 ... 1023

The command sets the value of the TFCI (Transport Format Combination Indicator) field. This value selects a combination of 30 bits, which are divided into two groups of 15 successive slots.

**Example:** "BB:W3GP:MST1:DPCC:TFCI 21"  
'sets the TFCI value to 21.

*RST value	Resolution	Options	SCPI
0	-	B10/B11 and B13 K42 SOURce2 only with second option B9/B10/B11	Device-specific

[SOURce<[1]>:]BB:W3GPp:MSTation<[1]>|2|3|4>:DPCCh:TFCI:STATe

The command activates the TFCI (Transport Format Combination Indicator) field for the DPCCH.

**Example:** "BB:W3GP:MST1:DPCC:TFCI:STAT ON"  
'activates the TFCI field.

*RST value	Resolution	Options	Dependency	SCPI
OFF	-	B10/B11 and B13 K42 SOURce2 only with second option B9/B10/B11	The command sets the slot format (BB:W3GP:MST:DPCC:SFOR) in conjunction with the set FBI mode (BB:W3GP:MST1:DPCC:FBI MODE) to the associated values.	Device-specific

[SOURce<[1]>:]BB:W3GPp:MSTation<[1]>|2|3|4>:DPCCh:TOFFset?

The command queries the timing offset. The timing offset indicates the time difference between the user equipment signal and the base station signal. This offset is fixed at 1024 chips, as defined in the standard .

The command is a query command and therefore does not have an \*RST value.

**Example:** "BB:W3GP:MST1:DPCC:TOFF?"  
'queries the timing offset.

*RST value	Resolution	Options	SCPI
1024	-	B10/B11 and B13 K42 SOURce2 only with second option B9/B10/B11	Device-specific

[SOURce<[1]|2>:]BB:W3GPp:MSTation<[1]|2|3|4>:DPCCh:TPC:DATA DLIS | ZERO | ONE | PATTErn

The command determines the data source for the TPC field of the DPCCH.

**Parameters: DLIS**

A data list is used. The data list is selected with the command  
:BB:W3GPp:MST:DPDCh:TPC:DATA:DSElect.

**ZERO | ONE**

Internal 0 and 1 data is used

**PATTErn**

Internal data is used. The bit pattern for the data is defined by the command  
BB:W3GPp:MST:DPCCh:TPC:DATA:PATTErn. The maximum length is 64 bits.

**Example:**

"BB:W3GP:MST2:DPCC:TPC:DATA PATT"  
'selects as the data source for the TPC field of user equipment 2 the bit pattern defined with the following command.  
"BB:W3GP:MST2:DPCC:TPC:DATA:PATT #H48D0,16"  
'defines the bit pattern.

*RST value	Resolution	Options	SCPI
PATTErn	-	B10/B11 and B13 K42 SOURce2 only with second option B9/B10/B11	Device-specific

[SOURce<[1]|2>:]BB:W3GPp:MSTation<[1]|2|3|4>:DPCCh:TPC:DATA:DSElect <data\_list>

The command selects the data list when the DLIS data source is selected for the TPC field of the DPCCH.

The files are stored with the fixed file extensions \*.dm\_iqd in a directory of the user's choice. The directory applicable to the commands is defined with the command MMEMoRY:CDIR. To access the files in this directory, you only have to give the file name, without the path and the file extension.

**Example:**

"BB:W3GP:MST1:DPCC:TPC:DATA DLIS" 'selects the Data Lists data source.  
"MMEM:CDIR 'D:\Lists\Dm\IQData'" 'selects the directory for the data lists.  
"BB:W3GP:MST1:DPCC:TPC:DATA:DSEL 'dpcch\_tpc\_1'"  
'selects the data list 'dpcch\_tpc1'.

*RST value	Resolution	Options	SCPI
''	-	B10/B11 and B13 K42 SOURce2 only with second option B9/B10/B11	Device-specific

**[SOURce<[1]|2>:]BB:W3GPP:MSTation<[1]|2|3|4>:DPCCh:TPC:DATA:PATtern**  
 #B0,1...B11..1,64

The command determines the bit pattern for the PATtern data source selection. The maximum length of the bit pattern is 64 bits.

**Example:** "BB:W3GP:MST1:DPCC:TPC:DATA:PATT #B11110000,8"  
 'defines the bit pattern of the data for the TPC field.

*RST value	Resolution	Options	SCPI
#H0, 1	-	B10/B11 and B13 K42 SOURce2 only with second option B9/B10/B11	Device-specific

**[SOURce<[1]|2>:]BB:W3GPP:MSTation<[1]|2|3|4>:DPCCh:TPC:MISuse ON | OFF**

The command activates "mis-" use of the TPC field (Transmit Power Control) for controlling the channel power of the user equipment.

The bit pattern (see commands :SOURce:BB:W3GPP:MSTation:DPCChh:TPC:DATA... ) of the TPC field of the DPCCH is used to control the channel power. A "1" leads to an increase of channel powers, a "0" to a reduction of channel powers. Channel power is limited to the range 0 dB to -80 dB. The step width for the change is defined by the command :SOURce:BB:W3GPP:MSTation:DPCC:TPC:PSTep.

**Example:** "BB:W3GP:MST:DPCC:TPC:MIS ON"  
 'activates regulation of the channel power via the bit pattern of the TPC field.  
 "BB:W3GP:MST:DPCC:TPC:PST 1 dB"  
 'sets the step width for the change of channel power to 1 dB.

*RST value	Resolution	Options	SCPI
OFF	-	B10/B11 and B13 K42 SOURce2 only with second option B9/B10/B11	Device-specific

**[SOURce<[1]|2>:]BB:W3GPP:MSTation<[1]|2|3|4>:DPCCh:TPC:PSTep -10 dB ... +10 dB**

The command sets the level of the power step in dB for controlling the transmit power via the data of the TPC field.

**Example:** "BB:W3GP:MST:DPCC:TPC:MIS ON"  
 'activates regulation of the channel power via the bit pattern of the TPC field.  
 "BB:W3GP:MST:DPCC:TPC:PST 1 dB"  
 'sets the step width for the change of channel power to 1 dB.

*RST value	Resolution	Options	SCPI
0 dB	0.1 dB	B10/B11 and B13 K42 SOURce2 only with second option B9/B10/B11	Device-specific

**[SOURce<[1]|2>:]BB:W3GPp:MSTation<[1]|2|3|4>:DPCCh:TPC:READ**

CONTInuous | S0A | S1A | S01A | S10A

The command sets the read out mode for the bit pattern of the TPC field of the DPCCH.

The bit pattern is selected with the command `SOUR:BB:W3GPp:MST:DPCC:TPC:DATA:PATT`.

**Parameters: CONTInuous**

The bit pattern is used cyclically.

**S0A**

The bit pattern is used once, then the TPC sequence continues with 0 bits.

**S1A**

The bit pattern is used once, then the TPC sequence continues with 1 bits.

**S01A**

The bit pattern is used once and then the TPC sequence is continued with 0 and 1 bits alternately (in multiples, depending on by the symbol rate, for example, 00001111).

**S10A**

The bit pattern is used once and then the TPC sequence is continued with 1 and 0 bits alternately (in multiples, depending on by the symbol rate, for example, 11110000).

**Example:**

`"BB:W3GP:MST2:DPCC:TPC:READ CONT"`

'the selected bit pattern is repeated continuously for the TPC sequence.

*RST value	Resolution	Options	SCPI
CONTInuous	-	B10/B11 and B13 K42 SOURce2 only with second option B9/B10/B11	Device-specific

**[SOURce<[1]|2>:]BB:W3GPp:MSTation<[1]|2|3|4>:HSUPa:DPCC:h:E:STATe ON | OFF**

The command activates or deactivates E-DPCCHs. This always activates or deactivates all the channels.

**Example:**

`"BB:W3GP:MST1:HSUP:DPCC:E:STAT ON"`

'activates all the E-DPCCHs.

*RST value	Resolution	Options	SCPI
OFF	-	B10/B11 and B13 K42 SOURce2 only with second option B9/B10/B11	Device-specific

**[SOURce<[1]|2>:]BB:W3GPp:MSTation<[1]|2|3|4>:HSUPa:DPCC:h:E:DTX:PATTern <string>**

The command sets the bit pattern for the DTX. The maximum length is 64 bits.

**Example:**

`"BB:W3GP:MST1:HSUP:DPCC:E:DTX:PATT "11-1-"`

'sets the bit pattern for the DTX.

*RST value	Resolution	Options	SCPI
1	-	B10/B11 and B13 K42 SOURce2 only with second option B9/B10/B11	Device-specific

[SOURce<[1]|2>:]BB:W3GPP:MSTation<[1]|2|3|4>:HSUPa:DPCCh:E:DTX:STATe ON | OFF

The command activates or deactivates the DTX (Discontinuous Transmission) mode.

If an FRC is set for the channel, this field is read-only.

**Example:** "BB:W3GP:MST1:HSUP:DPCC:E:DTX:STAT ON"  
'activates the DTX mode.

*RST value	Resolution	Options	SCPI
OFF	-	B10/B11 and B13 K42 SOURce2 only with second option B9/B10/B11	Device-specific

[SOURce<[1]|2>:]BB:W3GPP:MSTation<[1]|2|3|4>:HSUPa:DPCCh:E:HBIT ON | OFF

The command activates the happy bit.

**Example:** "BB:W3GP:MST1:HSUP:DPCC:E:HBIT ON"  
'sets the happy bit.

*RST value	Resolution	Options	SCPI
ON	-	B10/B11 and B13 K42 SOURce2 only with second option B9/B10/B11	Device-specific

[SOURce<[1]|2>:]BB:W3GPP:MSTation<[1]|2|3|4>:HSUPa:DPCCh:E:POWER -80dB...0dB

The command sets the power of the E-DPCCH channel.

**Example:** "BB:W3GP:MST1:HSUP:DPCC:E:POW -2.5dB"  
'sets the power of the E-DPCCH channel.

*RST value	Resolution	Options	SCPI
0	-	B10/B11 and B13 K42 SOURce2 only with second option B9/B10/B11	Device-specific

[SOURce<[1]|2>:]BB:W3GPP:MSTation<[1]|2|3|4>:HSUPa:DPCCh:E:RSNumber 0...3

The command sets the retransmission sequence number.

**Example:** "BB:W3GP:MST1:HSUP:DPCC:E:RSN 0"  
'sets the retransmission sequence number.

*RST value	Resolution	Options	SCPI
0	-	B10/B11 and B13 K42 SOURce2 only with second option B9/B10/B11	Device-specific



[SOURce<[1]|2>:]BB:W3GPp:MSTation<[1]|2|3|4>:HSUPa:DPCCh:E:TFCI 0...127

The command sets the value for the TFCI (Transport Format Combination Indicator) field.

**Example:** "BB:W3GP:MST1:HSUP:DPCC:E:TFCI 0"  
'sets the value for the TFCI.

*RST value	Resolution	Options	SCPI
0	-	B10/B11 and B13 K42 SOURce2 only with second option B9/B10/B11	Device-specific

[SOURce<[1]|2>:]BB:W3GPp:MSTation<[1]|2|3|4>:HSUPa:DPCCh:E:TTIEdch 2 | 10

The command sets the value for the TTI (Transmission Time Interval).

**Example:** "BB:W3GP:MST1:HSUP:DPCC:E:TTIE 2"  
'sets the value for the TTI to 2 ms.

*RST value	Resolution	Options	SCPI
2	-	B10/B11 and B13 K42 SOURce2 only with second option B9/B10/B11	Device-specific

[SOURce<[1]|2>:]BB:W3GPp:MSTation<[1]|2|3|4>:HSUPa:DPCCh:E:FRC:CHANnel 1...7

The command sets the FRC according to TS 25.141 Annex A.10.

**Example:** "SOUR:BB:W3GP:MST1:HSUP:DPCC:E:FRC:CHAN 4"  
'sets the FRC to channel 4.

*RST value	Resolution	Options	SCPI
4	-	B10/B11 and B13 K42 SOURce2 only with second option B9/B10/B11	Device-specific

[SOURce<[1]|2>:]BB:W3GPp:MSTation<[1]|2|3|4>:HSUPa:DPCCh:E:FRC:CRATe ?

The command queries the relation between the information bits to binary channel bits.

The command is a query command and therefore does not have an \*RST value.

**Example:** "SOUR1:BB:W3GP:MST1:HSUP:DPCC:E:FRC:CRAT?"  
'queries the coding rate.

Response: 0.705  
'the coding rate is 0.705.

*RST value	Resolution	Options	SCPI
-	-	B10/B11 and B13 K42 SOURce2 only with second option B9/B10/B11	Device-specific

[SOURce<[1]|2>:]BB:W3GPP:MSTation<[1]|2|3|4>:HSUPa:DPCCh:E:FRC:DERRor:BIT:LAYer  
TRANsport | PHYsical

The command sets the layer in the coding process at which bit errors are inserted.

**Example:** "SOUR:BB:W3GP:MST1:HSUP:DPCC:E:FRC:DERR:BIT:LAY TRAN"  
'sets the bit error insertion to the transport layer.

*RST value	Resolution	Options	SCPI
PHYsical	-	B10/B11 and B13 K42 SOURce2 only with second option B9/B10/B11	Device-specific

[SOURce<[1]|2>:]BB:W3GPP:MSTation<[1]|2|3|4>:HSUPa:DPCCh:E:FRC:DERRor:BIT:RATE  
10E-1...10E-7

The command sets the bit error rate.

**Example:** "SOUR:BB:W3GP:MST1:HSUP:DPCC:E:FRC:DERR:BIT:RATE 1e-3"  
'sets the bit error rate to 1e-3.

*RST value	Resolution	Options	SCPI
5E-3	-	B10/B11 and B13 K42 SOURce2 only with second option B9/B10/B11	Device-specific

[SOURce<[1]|2>:]BB:W3GPP:MSTation<[1]|2|3|4>:HSUPa:DPCCh:E:FRC:DERRor:BIT:STATE  
ON | OFF

The command activates or deactivates bit error generation.

**Example:** "SOUR:BB:W3GP:MST1:HSUP:DPCC:E:FRC:DERR:BIT:STAT ON"  
'activates the bit error state.

*RST value	Resolution	Options	SCPI
OFF	-	B10/B11 and B13 K42 SOURce2 only with second option B9/B10/B11	Device-specific

[SOURce<[1]|2>:]BB:W3GPP:MSTation<[1]|2|3|4>:HSUPa:DPCCh:E:FRC:DERRor:BLOCK:RATE  
10E-1...10E-4

The command sets the block error rate.

**Example:** "SOUR:BB:W3GP:MST1:HSUP:DPCC:E:FRC:DERR:BLOC:RATE 1E-3"  
'sets the block error rate.

*RST value	Resolution	Options	SCPI
5E-3	-	B10/B11 and B13 K42 SOURce2 only with second option B9/B10/B11	Device-specific

**[SOURce<[1]|2>:]BB:W3GPp:MSTation<[1]|2|3|4>:HSUPa:DPCCh:E:FRC:DERRor:BLOCK:STATe**  
ON | OFF

The command activates or deactivates block error generation.

**Example:** "SOUR:BB:W3GP:MST1:HSUP:DPCC:E:FRC:DERR:BLOC:STAT ON"  
'activates the block error generation.'

*RST value	Resolution	Options	SCPI
OFF	-	B10/B11 and B13 K42 SOURce2 only with second option B9/B10/B11	Device-specific

**[SOURce<[1]|2>:]BB:W3GPp:MSTation<[1]|2|3|4>:HSUPa:DPCCh:E:FRC:DTX:PATTern** <string>

The command sets the user-definable bit pattern for the DTX.

**Example:** "SOUR:BB:W3GP:MST1:HSUP:DPCC:E:FRC:DTX:PATT "11-1-"  
'sets the bit pattern for the DTX.'

*RST value	Resolution	Options	SCPI
"1"	-	B10/B11 and B13 K42 SOURce2 only with second option B9/B10/B11	

**[SOURce<[1]|2>:]BB:W3GPp:MSTation<[1]|2|3|4>:HSUPa:DPCCh:E:FRC:DTX:STATe** ON | OFF

The command activates or deactivates the DTX (Discontinuous Transmission) mode.

**Example:** "SOUR:BB:W3GP:MST1:HSUP:DPCC:E:FRC:DTX:STAT ON"  
'activates the DTX.'

*RST value	Resolution	Options	SCPI
OFF	-	B10/B11 and B13 K42 SOURce2 only with second option B9/B10/B11	Device-specific

**[SOURce<[1]|2>:]BB:W3GPp:MSTation<[1]|2|3|4>:HSUPa:DPCCh:E:FRC:HARQ:PATTern<CH>**  
<string>

The command sets the pattern for the HARQ-ACK field (Hybrid-ARQ Acknowledgement).

**Example:** "SOUR:BB:W3GP:MST1:HSUP:DPCC:E:FRC:HARQ:PATT4 "1010"  
'sets the bit pattern for the HARQ.'

*RST value	Resolution	Options	SCPI
	-	B10/B11 and B13 K42 SOURce2 only with second option B9/B10/B11	Device-specific

[SOURce<[1]|2>:]BB:W3GPp:MSTation<[1]|2|3|4>:HSUPa:DPCCh:E:FRC:HARQ:STATe ON |OFF

The command activates or deactivates the virtual HARQ mode.

**Example:** "SOUR:BB:W3GP:MST1:HSUP:DPCC:E:FRC:HARQ:STAT ON"  
'activates the virtual HARQ mode.'

*RST value	Resolution	Options	SCPI
OFF	-	B10/B11 and B13 K42 SOURce2 only with second option B9/B10/B11	Device-specific

[SOURce<[1]|2>:]BB:W3GPp:MSTation<[1]|2|3|4>:HSUPa:DPCCh:E:FRC:HPROcesses?

The command queries the number of HARQ (Hybrid-ARQ Acknowledgement) process.

The command is a query command and therefore does not have an \*RST value.

**Example:** "SOUR:BB:W3GP:MST1:HSUP:DPCC:E:FRC:HPRO?"  
'queries the number of HARQ processes.'

Response: 5

*RST value	Resolution	Options	SCPI
	-	B10/B11 and B13 K42 SOURce2 only with second option B9/B10/B11	Device-specific

[SOURce<[1]|2>:]BB:W3GPp:MSTation<[1]|2|3|4>:HSUPa:DPCCh:E:FRC:MIBRate?

The command queries the maximum information bit rate.

The command is a query command and therefore does not have an \*RST value.

**Example:** "SOUR:BB:W3GP:MST1:HSUP:DPCC:E:FRC:HPRO?"  
'queries the maximum information bit rate.'

Response: 1353.0

*RST value	Resolution	Options	SCPI
	-	B10/B11 and B13 K42 SOURce2 only with second option B9/B10/B11	Device-specific

**[SOURce<[1]|2>:]BB:W3GPp:MSTation<[1]|2|3|4>:HSUPa:DPCCh:E:FRC:PAYBits?**

The command queries the payload of the information bit. This value determines the number of transport layer bits sent in each HARQ process.

The command is a query command and therefore does not have an \*RST value.

**Example:** "SOUR:BB:W3GP:MST1:HSUP:DPCC:E:FRC:PAYB?"  
 'queries the payload of the information bit.

Response: 2706

*RST value	Resolution	Options	SCPI
	-	B10/B11 and B13 K42 SOURce2 only with second option B9/B10/B11	Device-specific

**[SOURce<[1]|2>:]BB:W3GPp:MSTation<[1]|2|3|4>:HSUPa:DPCCh:E:FRC:PCCodes?**

The command queries the number of the E-DPDCHs with the corresponding channelization codes.

The command is a query command and therefore does not have an \*RST value.

**Example:** "SOUR:BB:W3GP:MST1:HSUP:DPCC:E:FRC:PCCO?"  
 'queries the number of the E-DPDCHs with the corresponding channelization codes.

Response: 4 . 4

*RST value	Resolution	Options	SCPI
	-	B10/B11 and B13 K42 SOURce2 only with second option B9/B10/B11	Device-specific

**[SOURce<[1]|2>:]BB:W3GPp:MSTation<[1]|2|3|4>:HSUPa:DPCCh:E:FRC:STATE ON | OFF**

The command activates or deactivates the FRC state for the E-DPCCH channels.

**Example:** "SOUR:BB:W3GP:MST1:HSUP:DPCC:E:FRC:STAT ON"  
 'activates the FRC state for the E-DPCCH channels.

*RST value	Resolution	Options	SCPI
OFF	-	B10/B11 and B13 K42 SOURce2 only with second option B9/B10/B11	Device-specific

[SOURce<[1]|2>:]BB:W3GPP:MSTation<[1]|2|3|4>:HSUPa:DPCCh:E:FRC:TTIBits?

The command queries the number of physical bits sent in each HARQ process.

The command is a query command and therefore does not have an \*RST value.

**Example:** "SOUR:BB:W3GP:MST1:HSUP:DPCC:E:FRC:TTIB?"  
'queries the number of physical bits sent in each HARQ process.

*RST value	Resolution	Options	SCPI
	-	B10/B11 and B13 K42 SOURce2 only with second option B9/B10/B11	Device-specific

[SOURce<[1]|2>:]BB:W3GPP:MSTation<[1]|2|3|4>:HSUPa:DPCCh:E:FRC:TTIEdch?

The command queries the the TTI (Transmission Time Interval).

The command is a query command and therefore does not have an \*RST value.

**Example:** "SOUR:BB:W3GP:MST1:HSUP:DPCC:E:FRC:TTIE"  
'queries the TTI.

*RST value	Resolution	Options	SCPI
	-	B10/B11 and B13 K42 SOURce2 only with second option B9/B10/B11	Device-specific

[SOURce<[1]|2>:]BB:W3GPP:MSTation<[1]|2|3|4>:HSUPa:CHANnel<[1]...4>:DPDCh:E:CCODE?

The command queries the channelization code and the modulation branch (I or Q) of the DPDCH channel.

The channelization code is dependent on the overall symbol rate set and cannot be modified.

The command is a query command and therefore does not have an \*RST value.

**Example:** "BB:W3GP:MST4:HSUP:CHAN1:DPDC:E:CCOD?"  
'queries the channelization code and the modulation branch (I or Q)of E-DPDCH 1 of user equipment 4.

Response: "Q, 32"

*RST value	Resolution	Options	SCPI
-	-	B10/B11 and B13 K42 SOURce2 only with second option B9/B10/B11	Device-specific

[SOURce<[1]|2>:]BB:W3GPP:MSTation<[1]|2|3|4>:HSUPa:CHANnel<[1]...4>:DPDCh:DATA  
 PN9 | PN11 | PN15 | PN16 | PN16I | PN20 | PN21 | PN23 | ZERO | ONE | PATTErn | DLISt

The command selects the data source for the E-DPDCH channel.

**Parameters:**     **PNxx**  
 The pseudo-random sequence generator is used as the data source. Different random sequence lengths can be selected.

**DLISt**  
 A data list is used. The data list is selected with the command  
 SOURce:BB:W3GPP:MST:PCPCh:DATA:DSElect.

**ZERO | ONE**  
 Internal 0 and 1 data is used.

**PATTErn**  
 Internal data is used. The bit pattern for the data is defined by the command  
 SOUR:BB:W3GP:MST1:HSUP:CHAN1:DPDC:E:DATA PATT

**Example:**        "`SOUR:BB:W3GP:MST1:HSUP:CHAN1:DPDC:E:DATA PN11`"  
 'selects internal PRBS data with period length  $2^{11}-1$  as the data source.

*RST value	Resolution	Options	SCPI
PN9	-	B10/B11 and B13 K42 SOURce2 only with second option B9/B10/B11	Device-specific

[SOURce<[1]|2>:]BB:W3GPP:MSTation<[1]|2|3|4>:HSUPa:CHANnel<[1]...4>:DPDCh:E:DATA:DSE  
 Lect <data\_list\_name>

The command selects the data list for the DLISt data source.

The files are stored with the fixed file extensions \*.dm\_iqd in a directory of the user's choice. The directory applicable to the commands is defined with the command MMEMoRY:CDIR. To access the files in this directory, you only have to give the file name, without the path and the file extension.

**Example:**        "`SOUR:BB:W3GP:MST1:CHAN1:DPDC:E:DATA DLIS`"  
 'selects data lists as the data source.  
 "`MMEM:CDIR 'D:\Lists\Dm\IQData'`"  
 'selects the directory for the data lists.  
 "`BB:W3GP:MST1:CHAN1:DPDC:E:DATA:DSEL 'dp1'`"  
 'selects the data list 'dp1'.

*RST value	Resolution	Options	SCPI
-	-	B10/B11 and B13 K42 SOURce2 only with second option B9/B10/B11	Device-specific

**[SOURce<[1]|2>:]BB:W3GPP:MSTation<[1]|2|3|4>:HSUPa:CHANnel<[1]...4>:DPDCh:E:DATA:PAtern <bit pattern>**

The command determines the bit pattern for the data component when the PATtern data source is selected. The first parameter determines the bit pattern (choice of hexadecimal, octal or binary notation), the second specifies the number of bits to use.

**Example:** "SOUR:BB:W3GP:MST1:HSUP:CHAN1:DPDC:E:PATT #H3F,8"  
'defines the bit pattern of the data for the DATA component.

*RST value	Resolution	Options	SCPI
#H0, 1	-	B10/B11 and B13 K42 SOURce2 only with second option B9/B10/B11	Device-specific

**[SOURce<[1]|2>:]BB:W3GPP:MSTation<[1]|2|3|4>:HSUPa:DPDCh:E:DTX:PAtern <string>**

The command sets the bit pattern for the DTX. The maximim length is 64 bits.

**Example:** "BB:W3GP:MST1:HSUP:DPDC:E:DTX:PAtern "11-1-"  
'sets the bit pattern for the DTX.

*RST value	Resolution	Options	SCPI
1	-	B10/B11 and B13 K42 SOURce2 only with second option B9/B10/B11	Device-specific

**[SOURce<[1]|2>:]BB:W3GPP:MSTation<[1]|2|3|4>:HSUPa:DPDCh:E:DTX:STATe ON | OFF**

The command activates or deactivates the DTX (Discontinuous Transmission) mode.

If an FRC is set for the channel, this field is read-only.

**Example:** "BB:W3GP:MST1:HSUP:DPDC:E:DTX:STAT ON"  
'activates the DTX mode.

*RST value	Resolution	Options	SCPI
OFF	-	B10/B11 and B13 K42 SOURce2 only with second option B9/B10/B11	Device-specific



[SOURce<[1]|2>:]BB:W3GPP:MSTation<[1]|2|3|4>:HSUPa:DPDCh:E:FCIO ON | OFF

The command sets the channelization code to I/O.

**Example:** "BB:W3GP:MST1:HSUP:DPDC:E:FCIO ON"  
'sets the channelization code to I/O.

*RST value	Resolution	Options	SCPI
OFF	-	B10/B11 and B13 K42 SOURce2 only with second option B9/B10/B11	Device-specific

[SOURce<[1]|2>:]BB:W3GPP:MSTation<[1]|2|3|4>:HSUPa:DPDCh:E:ORATe D60K | D120K | D240K | D480K | D960K | D1920K | D2x1920K | D2x960K2x1920K

The command sets the overall symbol rate of all the E-DPDCH channels.

**Example:** "BB:W3GP:MST1:HSUP:DPDC:E:ORAT D60K"  
'sets the retransmission sequence number.

*RST value	Resolution	Options	SCPI
D60K	-	B10/B11 and B13 K42 SOURce2 only with second option B9/B10/B11	Device-specific

[SOURce<[1]|2>:]BB:W3GPP:MSTation<[1]|2|3|4>:HSUPa:DPDCh:E:POWER -80dB...0dB

The command sets the power of the E-DPDCH channel.

**Example:** "BB:W3GP:MST1:HSUP:DPDC:E:POW -2.5dB"  
'sets the power of the E-DPDCH channel.

*RST value	Resolution	Options	SCPI
0	-	B10/B11 and B13 K42 SOURce2 only with second option B9/B10/B11	Device-specific

[SOURce<[1]|2>:]BB:W3Gpp:MSTation<[1]|2|3|4>:HSUPa:CHANnel<[1]...4>:DPDCh:E:SRATe?

The command queries the symbol rate and the state of the E-DCDCH channel.

The symbol rate and the state of channel 2 to 6 are dependent on the overall symbol rate set and cannot be modified.

The command is a query command and therefore does not have an \*RST value.

**Example:** "BB:W3GP:MST4:HSUP:CHAN1:DPDC:E:SRAT?"  
'queries the symbol rate of E-DPDCH 1 of user equipment 4.

Response: "960"  
'the symbol rate is 960 ksp.

*RST value	Resolution	Options	SCPI
-	-	B10/B11 and B13 K42 SOURce2 only with second option B9/B10/B11	Device-specific

[SOURce<[1]|2>:]BB:W3Gpp:MSTation<[1]|2|3|4>:HSUPa:DPDCh:E:STATe ON | OFF

The command activates or deactivates the E-DPDCHs. This always activates or deactivates all the channels.

**Example:** "BB:W3GP:MST1:HSUP:DPDC:E:STAT ON"  
'activates all the E-DPDCHs.

*RST value	Resolution	Options	SCPI
ON	-	B10/B11 and B13 K42 SOURce2 only with second option B9/B10/B11	Device-specific

[SOURce<[1]|2>:]BB:W3Gpp:MSTation<[1]|2|3|4>:HSUPa:DPDCh:E:TTIEdch 2 | 10

The command sets the value for the TTI (Transmission Time Interval).

**Example:** "BB:W3GP:MST1:HSUP:DPDC:E:TTIE 2"  
'sets the value for the TTI to 2 ms.

*RST value	Resolution	Options	SCPI
2	-	B10/B11 and B13 K42 SOURce2 only with second option B9/B10/B11	Device-specific

[SOURce<[1]|2>:]BB:W3GPp:MSTation<[1]|2|3|4>:MODE PRACH | PPRACH | PCPCh | PPCPch | DPCDch

The command selects the operating mode for the user equipment.

**Parameters:**

**PRACH**

The user equipment only generates a signal with a physical random access channel (PRACH). This channel is used to set up the user equipment connection with the base station. The channel-specific parameters of the PRACH can be set with the commands

:SOURce:BB:W3GPp:MSTation<n>:PRACH:....

**PPRACH**

The user equipment only generates a signal with the preamble component of a physical random access channel (PRACH). The parameters of the PRACH preamble can be set with the commands

:SOURce:BB:W3GPp:MSTation<n>:PRACH:....

**PCPCh**

The user equipment only generates a signal with a physical common packet channel (PCPCH). This channel is used to transmit packet-oriented services (e.g. SMS). The channel-specific parameters of the PCPCH can be set with the commands

:SOURce:BB:W3GPp:MSTation<n>:PCPCh:....

**PPCPch**

The user equipment only generates a signal with the preamble component of a physical common packet channel (PCPCH). The parameters of the PCPCH preamble can be set with the commands

:SOURce:BB:W3GPp:MSTation<n>:PCPCh:....

**DPCDch**

The user equipment generates a signal with a dedicated physical control channel (DPCCH) and up to 6 dedicated physical data channels (DPDCH). This signal is used for voice and data transmission. The channel-specific parameters can be set with the commands

:SOURce:BB:W3GPp:MSTation<n>:DPCCh:... as well as  
 ...:CHANnel<n>:DPDCh<n>:... and ...:DPDCh<n>:....

**Example:**

"BB:W3GP:MST1:MODE DPCD"  
 'switches the user equipment to standard mode - transmission of voice and data.

*RST value	Resolution	Options	SCPI
DPCDch	-	B10/B11 and B13 K42 SOURce2 only with second option B9/B10/B11	Device-specific

**[SOURce<[1]|2>:]BB:W3Gpp:MSTation<[1]|2|3|4>:PCPCh:CPOWer -80 dB ... 0 dB**

The command defines the power of the control component of the PCPCH.

**Example:** "BB:W3GP:MST1:PCPC:CPOW -10 dB"  
'sets the power to -10 dB.

*RST value	Resolution	Options	SCPI
0 dB	0.1 dB	B10/B11 and B13 K42 SOURce2 only with second option B9/B10/B11	Device-specific

**[SOURce<[1]|2>:]BB:W3Gpp:MSTation<[1]|2|3|4>:PCPCh:CPSFormat 0 | 1 | 2**

The command defines the slot format of the control component of the PCPCH.

**Example:** "BB:W3GP:MST1:PCPC:CPSF 2"  
'sets slot format 2.

*RST value	Resolution	Options	Dependency	SCPI
0	-	B10/B11 and B13 K42 SOURce2 only with second option B9/B10/B11	The slot format sets the associated FBI mode automatically: Slot format 0 = FBI OFF Slot format 1 = FBI 1 bit Slot format 2 = FBI 2 bits	Device-specific

**[SOURce<[1]|2>:]BB:W3Gpp:MSTation<[1]|2|3|4>:PCPCh:DATA**

PN9 | PN11 | PN15 | PN16 | PN16I | PN20 | PN21 | PN23 | ZERO | ONE | PATtern

The command determines the data source for the PCPCH.

**Parameters:** **PNxx**

The pseudo-random sequence generator is used as the data source. Different random sequence lengths can be selected.

**DLIST**

A data list is used. The data list is selected with the command  
SOURce:BB:W3Gpp:MST:PCPCh:DATA:DSElect.

**ZERO | ONE**

Internal 0 and 1 data is used.

**PATtern**

Internal data is used. The bit pattern for the data is defined by the command  
SOURce:BB:W3Gpp:PCPCh:DATA:PATtern

**Example:** "BB:W3GP:MST1:PCPC:DATA PN11"  
'selects internal PRBS data with period length  $2^{11}-1$  as the data source.

*RST value	Resolution	Options	SCPI
PN9	-	B10/B11 and B13 K42 SOURce2 only with second option B9/B10/B11	Device-specific

**[SOURce<[1]|2>:]BB:W3GPp:MSTation<[1]|2|3|4>:PCPCh:DATA:DSElect <data\_list\_name>**

The command selects the data list for the DLIS data source.

The files are stored with the fixed file extensions \*.dm\_iqd in a directory of the user's choice. The directory applicable to the commands is defined with the command `MMEMory:CDIR`. To access the files in this directory, you only have to give the file name, without the path and the file extension.

**Example:**       `"BB:W3GP:MST1:PCPC:DATA DLIS"`  
                   'selects data lists as the data source.  
                   `"MMEM:CDIR 'D:\Lists\Dm\IQData'"`  
                   'selects the directory for the data lists.  
                   `"BB:W3GP:MST1:PCPC:DATA:DSEL 'pcpch_data'"`  
                   'selects the data list 'pcpch\_data'.

*RST value	Resolution	Options	SCPI
-	-	B10/B11 and B13 K42 SOURce2 only with second option B9/B10/B11	Device-specific

**[SOURce<[1]|2>:]BB:W3GPp:MSTation<[1]|2|3|4>:PCPCh:DATA:PATtern #B0,1...B11..1,64**

The command determines the bit pattern for the data component when the PATtern data source is selected. The first parameter determines the bit pattern (choice of hexadecimal, octal or binary notation), the second specifies the number of bits to use.

**Example:**       `"BB:W3GP:MST1:PCPC:DATA:PATT #H3F,8"`  
                   'defines the bit pattern of the data for the DATA component.

*RST value	Resolution	Options	SCPI
#H0, 1	-	B10/B11 and B13 K42 SOURce2 only with second option B9/B10/B11	Device-specific

**[SOURce<[1]|2>:]BB:W3GPp:MSTation<[1]|2|3|4>:PCPCh:DPOWER -80 dB ... 0 dB**

The command defines the power of the data component of the PCPCH.

**Example:**       `"BB:W3GP:MST1:PCPC:DPOW -10 dB"`  
                   'sets the power to -10 dB.

*RST value	Resolution	Options	SCPI
0 dB	0.1 dB	B10/B11 and B13 K42 SOURce2 only with second option B9/B10/B11	Device-specific

[SOURce<[1]|2>:]BB:W3GPP:MSTation<[1]|2|3|4>:PCPCh:FBI:MODE OFF | D1B | D2B

The command sets the number of bits (1 or 2) for the FBI field. With OFF, the field is not used.

**Example:** "BB:W3GP:MST2:PCPC:FBI:MODE OFF"  
'the FBI field is not used.'

*RST value	Resolution	Options	Dependency	SCPI
OFF	-	B10/B11 and B13 K42 SOURce2 only with second option B9/B10/B11	The FBI pattern automatically sets the associated slot format: FBI OFF = Slot format 0 FBI 1 bit = Slot format 1 FBI 2 bits = Slot format 2	Device-specific

[SOURce<[1]|2>:]BB:W3GPP:MSTation<[1]|2|3|4>:PCPCh:FBI:PATtern #B0,1...B11..1,32

The command determines the bit pattern for the FBI field when the PATtern data source is selected. The maximum length of the pattern is 32 bits.

The first parameter determines the bit pattern (choice of hexadecimal, octal or binary notation), the second specifies the number of bits to use.

**Example:** "BB:W3GP:MST1:PCPC:FBI:PATT #H3F,8"  
'defines the bit pattern of the data for the FBI field.'

*RST value	Resolution	Options	SCPI
#H0, 1	-	B10/B11 and B13 K42 SOURce2 only with second option B9/B10/B11	Device-specific

[SOURce<[1]|2>:]BB:W3GPP:MSTation<[1]|2|3|4>:PCPCh:MLENght 1 | 2 Frames

The command sets the length of the message component as a number of frames.

**Example:** "BB:W3GP:MST4:PCPC:MLEN 2"  
'the length of the message component is 2 frames.'

*RST value	Resolution	Options	SCPI
1 Frame	-	B10/B11 and B13 K42 SOURce2 only with second option B9/B10/B11	Device-specific

[SOURce<[1]|2>:]BB:W3GPP:MSTation<[1]|2|3|4>:PCPCh:PLENght S0 | S8

The command defines the length of the power control preamble of the PCPCH as a number of slots.

**Example:** "BB:W3GP:MST1:PCPC:PLEN S8"  
'sets a length of 8 slots for the power control preamble.'

*RST value	Resolution	Options	SCPI
S8	-	B10/B11 and B13 K42 SOURce2 only with second option B9/B10/B11	Device-specific

**[SOURce<[1]|2>:]BB:W3GPp:MSTation<[1]|2|3|4>:PCPCh:PPOWer -80 dB ... 0 dB**

The command defines the power of the preamble component of the PCPCH. If the preamble is repeated and the power increased with each repetition, this setting specifies the power achieved during the last repetition.

**Example:** "BB:W3GP:MST1:PCPC:PPOW -10 dB"  
 'sets the power to -10 dB.

"BB:W3GP:MST1:PCPC:PPOW:STEP 1 dB"  
 'sets an increase in power of 1 dB per preamble repetition.

"BB:W3GP:MST1:PCPC:PREP 2"  
 'sets a sequence of 2 preambles. The power of the first preamble is - 9 dB, the power of the second, -1 dB.

*RST value	Resolution	Options	SCPI
0 dB	0.1 dB	B10/B11 and B13; K42 SOURce2 only with second option B9/B10/B11	Device-specific

**[SOURce<[1]|2>:]BB:W3GPp:MSTation<[1]|2|3|4>:PCPCh:PPOWer:STEP 0 dB ... +10 dB**

The command defines the step width of the power increase, by which the preamble component of the PCPCH is increased from repetition to repetition. The power during the last repetition corresponds to the power defined by the command : SOURce:BB:W3GP:MST:PCPCh:PPOWer.

**Example:** "BB:W3GP:MST1:PCPC:PPOW:STEP 2 dB"  
 'the power of the PCPCH preamble is increased by 2 dB with every repetition.

*RST value	Resolution	Options	SCPI
0 dB	0.1 dB	B10/B11 and B13; K42 SOURce2 only with second option B9/B10/B11	Device-specific

**[SOURce<[1]|2>:]BB:W3GPp:MSTation<[1]|2|3|4>:PCPCh:PREPEtition 1 ... 10**

The command defines the number of PCPCH preamble components.

**Example:** "BB:W3GP:MST1:PCPC:PREP 3"  
 'sets three preamble components.

*RST value	Resolution	Options	SCPI
1		B10/B11 and B13; K42 SOURce2 only with second option B9/B10/B11	Device-specific

[SOURce<[1]>:]BB:W3GPP:MSTation<[1]>|2|3|4>:PCPCh:SIGNature 0 ... 15

The command selects the signature of the PCPCH (see Table 3 in 3GPP TS 25.213 Version 3.4.0 Release 1999).

**Example:** "BB:W3GP:MST1:PCPC:SIGN 5"  
'selects signature 5.

*RST value	Resolution	Options	SCPI
0		B10/B11 and B13; K42 SOURce2 only with second option B9/B10/B11	Device-specific

[SOURce<[1]>:]BB:W3GPP:MSTation<[1]>|2|3|4>:PCPCh:SRATe  
D15K | D30K | D60K | D120K | D240K | D480K | D960K

The command sets the symbol rate of the PCPCH.

**Example:** "BB:W3GP:MST1:PCPC:SRAT D15K"  
'sets the symbol rate of the PCPCH of user equipment 1 to 15 kbps.

*RST value	Resolution	Options	Dependencies	SCPI
D30K		B10/B11 and B13 K42 SOURce2 only with second option B9/B10/B11	<b>User Equipment 1:</b> When channel coding is active, the symbol rate is limited to the range between 15 and 120 kbps. Values above this limit are automatically set to 120 kbps.	Device-specific

[SOURce<[1]>:]BB:W3GPP:MSTation<[1]>|2|3|4>:PCPCh:TFCI 0 ... 1023

The command sets the value of the TFCI (Transport Format Combination Indicator) field. This value selects a combination of 30 bits, which are divided into two groups of 15 successive slots.

**Example:** "BB:W3GP:MST1:PCPC:TFCI 21"  
'sets the TFCI value to 21.

*RST value	Resolution	Options	SCPI
0	-	B10/B11 and B13 K42 SOURce2 only with second option B9/B10/B11	Device-specific



**[SOURce<[1]|2>:]BB:W3GPP:MSTation<[1]|2|3|4>:PCPCh:TIMing:DPOWer:MPARt?**

This command queries the level correction value for the message part. In case of one UE active, the power of the message part can be calculated by adding the set RF level.

The command represents a query and thus has no \*RST value.

**Example:** "BB:W3GP:MST3:PCPC:TIM:DPOW:MPAR?"  
'queries the level correction value for the message part.

Response: "1.2"  
'the correction value is 1.2 dB.

"POW?"  
'queries the RF level.

Response: "2"  
'the RF output level is 2 dBm. The message part power is 3.2 dBm.

*RST value	Resolution	Options	SCPI
-	-	B10/B11 and B13 K42 SOURce2 only with second option B9/B10/B11	Device-specific

**[SOURce<[1]|2>:]BB:W3GPP:MSTation<[1]|2|3|4>:PCPCh:TIMing:DPOWer:PREamble?**

This command queries level correction value for the last AICH preamble before the message part. This value is identical to the correction value for the CD preamble. The level of the other preambles can be calculated by subtracting the set **Preamble Power Step**.

The command represents a query and thus has no \*RST value.

**Example:** "BB:W3GP:MST3:PCPC:TIM:DPOW:PRE?"  
'queries the level correction value for the last AICH preamble before the message part.

*RST value	Resolution	Options	SCPI
-	-	B10/B11 and B13 K42 SOURce2 only with second option B9/B10/B11	Device-specific

**[SOURce<[1]|2>:]BB:W3GPP:MSTation<[1]|2|3|4>:PCPCh:TIMing:SOFFset 1 ... 14**

This command defines the start offset of the PCPCH in access slots. The starting time delay in timeslots is calculated according to: 2 x Start Offset.

**Example:** "BB:W3GP:MST3:PCPC:TIM:SOFF 1"  
'the start offset of the PCPCH of UE 3 is 2 access slots.

*RST value	Resolution	Options	SCPI
0	-	B10/B11 and B13 K42 SOURce2 only with second option B9/B10/B11	Device-specific

[SOURce<[1]|2>:]BB:W3GpP:MSTation<[1]|2|3|4>:PCPCh:TIMing:SPERiod?

This command queries the sequence period.

The command represents a query and thus has no \*RST value.

**Example:** "BB:W3GP:MST3:PCPC:TIM:SPER?"  
'queries the sequence period.

Response: "14"  
'the sequence period is 14 slots.

*RST value	Resolution	Options	SCPI
-	-	B10/B11 and B13 K42 SOURce2 only with second option B9/B10/B11	Device-specific

[SOURce<[1]|2>:]BB:W3GpP:MSTation<[1]|2|3|4>:PCPCh:TIMing:TIME:PREM 1 ... 14

This command defines the AICH Transmission Timing. This parameter defines the time difference between the preamble and the message part. Two modes are defined in the standard. In mode 0, the preamble to message part difference is 3 access slots, in mode 1 it is 4 access slots.

**Example:** "BB:W3GP:MST3:PCPC:TIM.TIME:PREM 3"  
'the difference between the preamble and the message part is 3 access slots.

*RST value	Resolution	Options	SCPI
3	-	B10/B11 and B13 K42 SOURce2 only with second option B9/B10/B11	Device-specific

[SOURce<[1]|2>:]BB:W3GpP:MSTation<[1]|2|3|4>:PCPCh:TIMing:TIME:PREPre 1 ... 14

This command defines the time difference between two successive preambles in access slots.

**Example:** "BB:W3GP:MST3:PCPC:TIM.TIME:PREP 3"  
'the time difference between two successive preambles is 3 access slots.

*RST value	Resolution	Options	SCPI
3	-	B10/B11 and B13 K42 SOURce2 only with second option B9/B10/B11	Device-specific

**[SOURce<[1]|2>:]BB:W3GPP:MSTation<[1]|2|3|4>:PCPCh:TPC:DATA DLISt ZERO| ONE| PATTErn**

The command determines the data source for the TPC field of the PCPCH.

**Parameters: DLISt**

A data list is used. The data list is selected with the command  
:BB:W3GPP:MST:PCPCh:DATA:DSEL.

**ZERO | ONE**

Internal 0 and 1 data is used.

**PATTErn**

Internal data is used. The bit pattern for the data is defined by the command  
:BB:W3GPP:MST:PCPCh:DATA:PATTErn. The maximum length is 64 bits.

**Example:**

"BB:W3GP:MST2:PCPC:TPC:DATA PATT"  
'selects as the data source for the TPC field of user equipment 2 the bit pattern defined with the following command.  
"BB:W3GP:MST2:PCPC:TPC:DATA:PATT #H48D0,16"  
'defines the bit pattern.

*RST value	Resolution	Options	SCPI
PATTErn	-	B10/B11 and B13 K42 SOURce2 only with second option B9/B10/B11	Device-specific

**[SOURce<[1]|2>:]BB:W3GPP:MSTation<[1]|2|3|4>:PCPCh:TPC:DATA:DSELEct <data\_list>**

The command selects the data list when the DLISt data source is selected for the TPC field of the PCPCH. The files are stored with the fixed file extensions \*.dm\_iqd in a directory of the user's choice. The directory applicable to the commands is defined with the command MMEMoRY:CDIR. To access the files in this directory, you only have to give the file name, without the path and the file extension.

**Example:**

BB:W3GP:MST1:PCPC:TPC:DATA DLIS  
'selects data lists as the data source.  
MMEMoRY:CDIR 'D:\Lists\Dm\IQData'  
'selects the directory for the data lists.  
BB:W3GP:MST1:PCPC:TPC:DATA:DSEL 'dpcch\_tpc\_1'  
'selects the data list 'dpcch\_tpc1'.

*RST value	Resolution	Options	SCPI
'	-	B10/B11 and B13; K42 SOURce2 only with second option B9/B10/B11	Device-specific

[SOURce<[1]|2>:]BB:W3GpP:MSTation<[1]|2|3|4>:PCPCh:TPC:DATA:PATtern #B0,1...B11..1,64

The command determines the bit pattern for the PATtern data source selection. The maximum length of the bit pattern is 64 bits.

**Example:** "BB:W3GP:MST1:PCPC:DATA:PATT #H3F,8"  
 'defines the bit pattern of the data for the FBI field.

*RST value	Resolution	Options	SCPI
#H0, 1	-	B10/B11 and B13; K42 SOURce2 only with second option B9/B10/B11	Device-specific

[SOURce<[1]|2>:]BB:W3GpP:MSTation<[1]|2|3|4>:PCPCh:TPC:READ

CONTInuous | S0A | S1A | S01A | S10A

The command sets the read out mode for the bit pattern of the TPC field of the PCPCH. The bit pattern is selected with the command :SOURce:BB:W3GpP:MST:PCPC:TPC:DATA.

**Parameters:** **CONTInuous**  
 The bit pattern is used cyclically.

**S0A**  
 The bit pattern is used once, then the TPC sequence continues with 0 bits.

**S1A**  
 The bit pattern is used once, then the TPC sequence continues with 1 bits.

**S01A**  
 The bit pattern is used once and then the TPC sequence is continued with 0 and 1 bits alternately (in multiples, depending on by the symbol rate, for example, 00001111).

**S10A**  
 The bit pattern is used once and then the TPC sequence is continued with 1 and 0 bits alternately (in multiples, depending on by the symbol rate, for example, 11110000).

**Example:** "BB:W3GP:MST2:PCPC:TPC:READ CONT"  
 'the selected bit pattern is repeated continuously for the TPC sequence.

*RST value	Resolution	Options	SCPI
CONTInuous	-	B10/B11 and B13; K42 SOURce2 only with second option B9/B10/B11	Device-specific

**[SOURce<[1]|2>:]BB:W3GPp:MSTation<[1]|2|3|4>:PRACH:CPOWER -80 dB ... 0 dB**

The command defines the power of the control component of the PRACH.

**Example:** "BB:W3GP:MST1:PRAC:CPOW -10 dB"  
'sets the power to -10 dB.

*RST value	Resolution	Options	SCPI
0 dB	0.1 dB	B10/B11 and B13 K42 SOURce2 only with second option B9/B10/B11	Device-specific

**[SOURce<[1]|2>:]BB:W3GPp:MSTation<[1]|2|3|4>:PRACH:DATA  
PN9 | PN15 | PN16 | PN20 | PN21 | PN23 | DLISt | ZERO | ONE | PATTErn**

The command determines the data source for the PRACH.

**Parameters:** **PNxx**  
The pseudo-random sequence generator is used as the data source. Different random sequence lengths can be selected.

**DLISt**  
A data list is used. The data list is selected with the command  
:BB:W3GPp:MST:PRACH:DATA:DSElect.

**ZERO | ONE**  
Internal 0 and 1 data is used.

**PATTErn**  
Internal data is used. The bit pattern for the data is defined by the command  
:BB:W3GPp:PRACH:DATA:PATTErn

**Example:** "BB:W3GP:MST1:PRAC:DATA PN11"  
'selects internal PRBS data with period length  $2^{11}-1$  as the data source.

*RST value	Resolution	Options	SCPI
PN9	-	B10/B11 and B13 K42 SOURce2 only with second option B9/B10/B11	Device-specific

**[SOURce<[1]|2>:]BB:W3GPp:MSTation<[1]|2|3|4>:PRACH:DATA:DSElect <data\_list\_name>**

The command selects the data list for the DLIS data source.

The files are stored with the fixed file extensions \*.dm\_iqd in a directory of the user's choice. The directory applicable to the commands is defined with the command `MMEMory:CDIR`. To access the files in this directory, you only have to give the file name, without the path and the file extension.

**Example:**       `"BB:W3GP:MST1:PRAC:DATA DLIS"`  
                   'selects data lists as the data source.

`"MMEM:CDIR 'D:\Lists\Dm\IQData'"`  
                   'selects the directory for the data lists.

`"BB:W3GP:MST1:PRAC:DATA:DSEL 'pcpch_data'"`  
                   'selects the data list 'pcpch\_data'.

*RST value	Resolution	Options	SCPI
-	-	B10/B11 and B13 K42 SOURce2 only with second option B9/B10/B11	Device-specific

**[SOURce<[1]|2>:]BB:W3GPp:MSTation<[1]|2|3|4>:PRACH:DATA:PATtern #B0,1..B11..1,64**

The command determines the bit pattern for the data component when the PATtern data source is selected. The first parameter determines the bit pattern (choice of hexadecimal, octal or binary notation), the second specifies the number of bits to use.

**Example:**       `"BB:W3GP:MST1:PRAC:DATA:PATT #H3F, 8"`  
                   'defines the bit pattern of the data for the DATA component.

*RST value	Resolution	Options	SCPI
#H0, 1	-	B10/B11 and B13; K42 SOURce2 only with second option B9/B10/B11	Device-specific

**[SOURce<[1]|2>:]BB:W3GPp:MSTation<[1]|2|3|4>:PRACH:DPOWER -80 dB ... 0 dB**

The command defines the power of the data component of the PRACH.

**Example:**       `"BB:W3GP:MST1:PRAC:DPOW -10 dB"`  
                   'sets the power to -10 dB.

*RST value	Resolution	Options	SCPI
0 dB	0.1 dB	B10/B11 and B13; K42 SOURce2 only with second option B9/B10/B11	Device-specific

**[SOURce<[1]|2>:]BB:W3GPp:MSTation<[1]|2|3|4>:PRACH:MLENgtH 1 | 2 Frames**

The command sets the length of the message component as a number of frames.

**Example:** "BB:W3GP:MST4:PRAC:MLEN 2"  
'the length of the message component is 2 frames.

*RST value	Resolution	Options	SCPI
1 Frame	-	B10/B11 and B13 ; K42 SOURce2 only with second option B9/B10/B11	Device-specific

**[SOURce<[1]|2>:]BB:W3GPp:MSTation<[1]|2|3|4>:PRACH:PPOWER -80 dB ... 0 dB**

The command defines the power of the preamble component of the PRACH. If the preamble is repeated and the power increased with each repetition, this setting specifies the power achieved during the last repetition.

**Example:** "BB:W3GP:MST1:PRAC:PPOW -10 dB"  
'sets the power to -10 dB.

"BB:W3GP:MST1:PRAC:PPOW:STEP 1 dB"  
'sets an increase in power of 1 dB per preamble repetition.

"BB:W3GP:MST1:PRAC:PREP 2"  
'sets a sequence of 2 preambles. The power of the first preamble is - 9 dB, the power of the second, -1 dB.

*RST value	Resolution	Options	SCPI
0 dB	0.1 dB	B10/B11 and B13; K42 SOURce2 only with second option B9/B10/B11	Device-specific

**[SOURce<[1]|2>:]BB:W3GPp:MSTation<[1]|2|3|4>:PRACH:PPOWER:STEP 0 dB ... +10 dB**

The command defines the step width of the power increase, by which the preamble component of the PRACH is increased from repetition to repetition. The power defined during the last repetition corresponds to the power defined by the command : SOURce:BB:W3GPp:MST:PRACH:PPOWER.

**Example:** "BB:W3GP:MST1:PRAC:PPOW:STEP 2 dB"  
'the power of the PRACH preamble is increased by 2 dB with every repetition.

*RST value	Resolution	Options	SCPI
0 dB	0.1 dB	B10/B11 and B13 K42 SOURce2 only with second option B9/B10/B11	Device-specific

[SOURce<[1]|2>:]BB:W3GPp:MSTation<[1]|2|3|4>:PRACH:PREPetition 1 ... 10

The command defines the number of PRACH preamble components.

**Example:** "BB:W3GP:MST1:PRAC:PREP 3"  
'sets three preamble components.

*RST value	Resolution	Options	SCPI
1		B10/B11 and B13 K42 SOURce2 only with second option B9/B10/B11	Device-specific

[SOURce<[1]|2>:]BB:W3GPp:MSTation<[1]|2|3|4>:PRACH:SFORmat 0 | 1 | 2 | 3

The command defines the slot format of the PRACH.

**Example:** "BB:W3GP:MST:PRAC:SFOR 2"  
'sets slot format 2.

*RST value	Resolution	Options	Dependency	SCPI
0	-	B10/B11 and B13 K42 SOURce2 only with second option B9/B10/B11	A change of slot format leads to an automatic change of symbol rate :BB:W3GPp:MST:PRACH:SRATe User Equipment 1: When channel coding is active, the slot format is predetermined. So in this case, the command has no effect.	Device-specific

[SOURce<[1]|2>:]BB:W3GPp:MSTation<[1]|2|3|4>:PRACH:SIGNature 0 ... 15

The command selects the signature of the PRACH (see Table 3 in 3GPP TS 25.213 Version 3.4.0 Release 1999).

**Example:** "BB:W3GP:MST1:PRAC:SIGN 5"  
'selects signature 5.

*RST value	Resolution	Options	SCPI
0		B10/B11 and B13 K42 SOURce2 only with second option B9/B10/B11	Device-specific



[SOURce<[1]|2>:]BB:W3GPp:MSTation<[1]|2|3|4>:PRACH:SRATe D15K | D30K | D60K | D120K

The command sets the symbol rate of the PRACH.

**Example:** "BB:W3GP:MST1:PRAC:SRAT D15K"  
'sets the symbol rate of the PRACH of user equipment 1 to 15 ksp.

*RST value	Resolution	Options	Dependency	SCPI
D30K	-	B10/B11 and B13 K42 SOURce2 only with second option B9/B10/B11	A change of symbol rate leads to an automatic change of slot format :BB:W3GPp:MST:PRACH:SFOFormat	Device-specific

[SOURce<[1]|2>:]BB:W3GPp:MSTation<[1]|2|3|4>:PRACH:TFCI 0 ... 1023

The command sets the value of the TFCI (Transport Format Combination Indicator) field. This value selects a combination of 30 bits, which are divided into two groups of 15 successive slots.

**Example:** "BB:W3GP:MST1:PRAC:TFCI 21"  
'sets the TFCI value to 21.

*RST value	Resolution	Options	SCPI
0	-	B10/B11 and B13 K42 SOURce2 only with second option B9/B10/B11	Device-specific

[SOURce<[1]|2>:]BB:W3GPp:MSTation<[1]|2|3|4>:PRACH:TIMing:DPOWER:MPARt?

This command queries the level correction value for the message part. In case of one UE active, the power of the message part can be calculated by adding the set RF level.

The command represents a query and thus has no \*RST value.

**Example:** "BB:W3GP:MST3:PRAC:TIM:DPOW:MPAR?"  
'queries the level correction value for the message part.

Response: "1.2"  
'the correction value is 1.2 dB.

"POW?"  
'queries the RF level.

Response: "2"  
'the RF output level is 2 dBm. The message part power is 3.2 dBm.

*RST value	Resolution	Options	SCPI
-	-	B10/B11 and B13 K42 SOURce2 only with second option B9/B10/B11	Device-specific

[SOURce<[1]|2>:]BB:W3Gpp:MSTation<[1]|2|3|4>:PRACH:TIMing:DPOWer:MPARt:CONTRol?

This command queries the level correction value for the message control part.

The command represents a query and thus has no \*RST value.

**Example:** "BB:W3GP:MST3:PRAC:TIM:DPOW:MPAR:CONT?"  
'queries the level correction value for the message control part.

Response: "-3.24"  
'the correction value is -3.24 dB.

*RST value	Resolution	Options	SCPI
-	-	B10/B11 and B13 K42 SOURce2 only with second option B9/B10/B11	Device-specific

[SOURce<[1]|2>:]BB:W3Gpp:MSTation<[1]|2|3|4>:PRACH:TIMing:DPOWer:MPARt:DATA?

This command queries the level correction value for the message data part.

The command represents a query and thus has no \*RST value.

**Example:** "BB:W3GP:MST3:PRAC:TIM:DPOW:MPAR:DATA?"  
'queries the level correction value for the message data part.

Response: "-3.24"  
'the correction value is -3.24 dB.

*RST value	Resolution	Options	SCPI
-	-	B10/B11 and B13 K42 SOURce2 only with second option B9/B10/B11	Device-specific

[SOURce<[1]|2>:]BB:W3Gpp:MSTation<[1]|2|3|4>:PRACH:TIMing:DPOWer:PREAmble?

This command queries level correction value for the preamble before the message part. The level of the other preambles can be calculated by subtracting the set **Preamble Power Step**.

The command represents a query and thus has no \*RST value.

**Example:** "BB:W3GP:MST3:PRAC:TIM:DPOW:PRE?"  
'queries the level correction value for the last preamble before the message part.

*RST value	Resolution	Options	SCPI
-	-	B10/B11 and B13 K42 SOURce2 only with second option B9/B10/B11	Device-specific

**[SOURCE<[1]>:]BB:W3GPP:MSTation<[1]>|2|3|4>:PRACH:TIMing:SOFFset 1 ... 50**

This command defines the start offset of the PRACH in access slots. The starting time delay in timeslots is calculated according to: 2 x Start Offset.

**Example:** "BB:W3GP:MST3:PRAC:TIM:SOFF 1"  
'the start offset of the PRACH of UE 3 is 2 access slots.

*RST value	Resolution	Options	SCPI
0	-	B10/B11 and B13 K42 SOURCE2 only with second option B9/B10/B11	Device-specific

**[SOURCE<[1]>:]BB:W3GPP:MSTation<[1]>|2|3|4>:PRACH:TIMing:SPERiod?**

This command queries the sequence period.

The command represents a query and thus has no \*RST value.

**Example:** "BB:W3GP:MST3:PRAC:TIM:SPER?"  
'queries the sequence period.

Response: "14"  
'the sequence period is 14 slots.

*RST value	Resolution	Options	SCPI
-	-	B10/B11 and B13 K42 SOURCE2 only with second option B9/B10/B11	Device-specific

**[SOURCE<[1]>:]BB:W3GPP:MSTation<[1]>|2|3|4>:PRACH:TIMing:TIME:PREMp 1 ... 14**

This command defines the AICH Transmission Timing. This parameter defines the time difference between the preamble and the message part. Two modes are defined in the standard. In mode 0, the preamble to message part difference is 3 access slots, in mode 1 it is 4 access slots.

**Example:** "BB:W3GP:MST3:PRAC:TIM:TIME:PREM 3"  
'the difference between the preamble and the message part is 3 access slots.

*RST value	Resolution	Options	SCPI
3	-	B10/B11 and B13 K42 SOURCE2 only with second option B9/B10/B11	Device-specific

**[SOURce<[1]|2>:]BB:W3GpP:MSTation<[1]|2|3|4>:PRACH:TIMing:TIME:PREPre 1 ... 14**

This command defines the time difference between two successive preambles in access slots.

**Example:** "BB:W3GP:MST3:PRAC:TIM.TIME:PREP 3"  
 'the time difference between two successive preambles is 3 access slots.

*RST value	Resolution	Options	SCPI
3	-	B10/B11 and B13 K42 SOURce2 only with second option B9/B10/B11	Device-specific

**[SOURce<[1]|2>:]BB:W3GpP:MSTation:PRESet**

The command produces a standardized default for all the user equipment. The settings correspond to the \*RST values specified for the commands.

This command triggers an action and therefore has no \*RST value and no query form.

**Example:** "BB:W3GP:MST:PRES"  
 'resets all the user equipment settings to default values.

*RST value	Resolution	Options	Dependencies	SCPI
-	-	B10/B11 and B13 K42 SOURce2 only with second option B9/B10/B11	All user equipment settings are preset.  An overview is provided by Table in Chapter 4.	Device-specific

**[SOURce<[1]|2>:]BB:W3GpP:MSTation<[1]|2|3|4>:SCODE #H0...#FFFFFFF**

The command sets the scrambling code. Long or short scrambling codes can be generated (command :BB:W3GP:MST2:SCOD:MODE).

**Example:** "BB:W3GP:MST2:SCOD #H12"  
 'sets scrambling code #12.

*RST value	Resolution	Options	SCPI
#H0	-	B10/B11 and B13 K42 SOURce2 only with second option B9/B10/B11	Device-specific

**[SOURce<[1]|2>:]BB:W3GPp:MSTation<[1]|2|3|4>:SCODE:MODE SHORT | LONG | OFF**

The command sets the type for the scrambling code. The scrambling code generator can also be deactivated for test purposes.

SHORT is only standardized for the selection :BB:W3GP:MST:MODE DPCDh and :BB:W3GP:MST:MODE PCPCh. But it can also be generated for the PCPCH for test purposes.

**Example:** "BB:W3GP:MST2:SCOD:MODE OFF"  
'deactivates the scrambling code generator.

*RST value	Resolution	Options	SCPI
LONG	-	B10/B11 and B13 K42 SOURce2 only with second option B9/B10/B11	Device-specific

**[SOURce<[1]|2>:]BB:W3GPp:MSTation<[1]|2|3|4>:STATE ON | OFF**

The command activates and deactivates the specified user equipment.

**Example:** "BB:W3GP:MST2:STAT OFF"  
'deactivates user equipment 2.

*RST value	Resolution	Options	SCPI
ON	-	B10/B11 and B13 K42 SOURce2 only with second option B9/B10/B11	Device-specific

**[SOURce<[1]|2>:]BB:W3GPp:MSTation<2|3|4>:TDElay 0 ... 38400 chips**

The command sets the time shift of the selected user equipment compared to user equipment 1 in chips.

The command is only valid for user equipment 2, 3 and 4. So a suffix must be specified at MSTation (2, 3, or 4).

**Example:** "BB:W3GP:MST2:TDEL 256"  
'shifts user equipment 2 by 256 chips compared to user equipment 1.

*RST value	Resolution	Options	SCPI
0		B10/B11 and B13 K42 SOURce2 only with second option B9/B10/B11	Device-specific

## SOURce:W3GPP - Enhanced Channels of the User Equipment

The SOURce:BB:W3GPP:MSTation:ENHanced subsystem contains the commands for setting the enhanced channels of user equipment 1 (UE1). The channels of UE1 are always generated in enhanced mode. The commands of this system only take effect when the 3GPP FDD standard is activated, the uplink transmission direction is selected and user equipment 1 is enabled:

SOURce:BB:W3GPP:STATE ON

SOURce:BB:W3GPP:LINK UP

SOURce:BB:W3GPP:MSTation1:STATE ON

Command	Parameters	Default unit	Comments
[SOURce<[1] 2>:]BB:W3GPP:MSTation:ENHanced:DPDCh:BPFRame?			Query only
[SOURce<[1] 2>:]BB:W3GPP:MSTation:ENHanced:DPDCh:CCODing:STATE	ON   OFF		
[SOURce<[1] 2>:]BB:W3GPP:MSTation:ENHanced:DPDCh:CCODing:TYPE	M12K2   M64K   M144K   M384K   AMR		
[SOURce<[1] 2>:]BB:W3GPP:MSTation:ENHanced:DPDCh:CCODing:USER:C ATalog?			Query only
[SOURce<[1] 2>:]BB:W3GPP:MSTation:ENHanced:DPDCh:CCODing:USER:D ELete	<u_coding>		No query
[SOURce<[1] 2>:]BB:W3GPP:MSTation:ENHanced:DPDCh:CCODing:USER:L OAD	<u_coding>		No query
[SOURce<[1] 2>:]BB:W3GPP:MSTation:ENHanced:DPDCh:CCODing:USER:S TORe	<u_coding>		No query
[SOURce<[1] 2>:]BB:W3GPP:MSTation:ENHanced:DPDCh:DERRor:BIT:LAYer	TRANSport   PHYSical		
[SOURce<[1] 2>:]BB:W3GPP:MSTation:ENHanced:DPDCh:DERRor:BIT:RATE	1E-7...5E-1		
[SOURce<[1] 2>:]BB:W3GPP:MSTation:ENHanced:DPDCh:DERRor:BIT:STAT e	ON   OFF		
[SOURce<[1] 2>:]BB:W3GPP:MSTation:ENHanced:DPDCh:DERRor:BLOCK:R ATE	1E-4...5E-1		
[SOURce<[1] 2>:]BB:W3GPP:MSTation:ENHanced:DPDCh:DERRor:BLOCK:ST ATe	ON   OFF		
[SOURce<[1] 2>:]BB:W3GPP:MSTation:ENHanced:DPDCh:DPControl:DIRectio n	UP   DOWN		
[SOURce<[1] 2>:]BB:W3GPP:MSTation:ENHanced:DPDCh:DPControl:MODE	EXTernal   TPC   MANual		
[SOURce<[1] 2>:]BB:W3GPP:MSTation:ENHanced:DPDCh:DPControl:[:POWER ]			Query only
[SOURce<[1] 2>:]BB:W3GPP:MSTation:ENHanced:DPDCh:DPControl:RANGE: DOWN	0.0 ...30.0dB		
[SOURce<[1] 2>:]BB:W3GPP:MSTation:ENHanced:DPDCh:DPControl:RANGE: UP	0.0 ...30.0dB		
[SOURce<[1] 2>:]BB:W3GPP:MSTation:ENHanced:DPDCh:DPControl:STATE	ON   OFF		
[SOURce<[1] 2>:]BB:W3GPP:MSTation:ENHanced:DPDCh:DPControl:STEP:M ANual	MAN0   MAN1		
[SOURce<[1] 2>:]BB:W3GPP:MSTation:ENHanced:DPDCh:DPControl:STEP[:E XTernal]	0.25... 6.0dB		

Command	Parameters	Default unit	Comments
[SOURce<[1]>:]BB:W3GPP:MSTation:ENHanced:DPDCh:INTerleaver2	ON   OFF		
[SOURce<[1]>:]BB:W3GPP:MSTation:ENHanced:DPDCh:ORATe?			Query only
[SOURce<[1]>:]BB:W3GPP:MSTation:ENHanced:DPDCh:TCHannel<0[[1]...6>:CRCSIZE	NONE   8   12   16   24		
[SOURce<[1]>:]BB:W3GPP:MSTation:ENHanced:DPDCh:TCHannel<0[[1]...6>:DATA	PN9   PN11   PN15   PN16   PN20   PN21   PN23   DLIS   ZERO   ONE   PATtern		
[SOURce<[1]>:]BB:W3GPP:MSTation:ENHanced:DPDCh:TCHannel<0[[1]...6>:DATA:DSElect	<data_list>		
[SOURce<[1]>:]BB:W3GPP:MSTation:ENHanced:DPDCh:TCHannel<0[[1]...6>:DATA:PATtern	:PRACH:DAT A:PATtern		
[SOURce<[1]>:]BB:W3GPP:MSTation:ENHanced:DPDCh:TCHannel<0[[1]...6>:EPRotecton	NONE   TURBo3   CON2   CON3		
[SOURce<[1]>:]BB:W3GPP:MSTation:ENHanced:DPDCh:TCHannel<0[[1]...6>:INTerleaver[1]	ON   OFF		
[SOURce<[1]>:]BB:W3GPP:MSTation:ENHanced:DPDCh:TCHannel<0[[1]...6>:RMAtributE	16 ... 1024		
[SOURce<[1]>:]BB:W3GPP:MSTation:ENHanced:DPDCh:TCHannel<0[[1]...6>:STATe	ON   OFF		
[SOURce<[1]>:]BB:W3GPP:MSTation:ENHanced:DPDCh:TCHannel<0[[1]...6>:TBCount			
[SOURce<[1]>:]BB:W3GPP:MSTation:ENHanced:DPDCh:TCHannel<0[[1]...6>:TBSIZE	0 ... 4096		
[SOURce<[1]>:]BB:W3GPP:MSTation:ENHanced:DPDCh:TCHannel<0[[1]...6>:TTINterval	10MS   20MS   40MS   80MS	s	
[SOURce<[1]>:]BB:W3GPP:MSTation:ENHanced:PCPCh:CCODing:STATe	ON   OFF		
[SOURce<[1]>:]BB:W3GPP:MSTation:ENHanced:PCPCh:CCODing:TYPE	TB168   TB360		
[SOURce<[1]>:]BB:W3GPP:MSTation:ENHanced:PRACH:CCODing:STATe	ON   OFF		
[SOURce<[1]>:]BB:W3GPP:MSTation:ENHanced:PRACH:CCODing:TYPE	TB168   TB360		

**[SOURce<[1]>:]BB:W3GPP:MSTation:ENHanced:DPDCh:BPFRame?**

The command queries the number of data bits in the DPDCH component of the frame at the physical layer. The number of data bits depends on the overall symbol rate.

The command is a query command and therefore does not have an \*RST value.

**Example:** "BB:W3GP:MST:ENH:DPDC:BPFR?"  
'queries the number of data bits

Response: "300"  
'the number of data bits is 300

*RST value	Resolution	Options	SCPI
-	-	B10/B11 and B13 K42 SOURce2 only with second option B9/B10/B11	Device-specific

[SOURce<[1]|2>:]BB:W3GPP:MSTation:ENHanced:DPDCh:CCODing:STATe ON | OFF

The command activates or deactivates channel coding for the enhanced channels.

**Example:** "BB:W3GP:MST:ENH:DPDC:CCOD:TYPE M12K2"  
 'selects channel coding type RMC 12.2 kbps.  
 "BB:W3GP:MST:ENH:DPDC:CCOD:STAT ON"  
 'activates channel coding.

*RST value	Resolution	Options	Dependency	SCPI
OFF	-	B10/B11 and B13 K42 SOURce2 only with second option B9/B10/B11	When channel coding is activated, the overall symbol rate (:BB:W3GP:MST:DPDCh:ORATe) is set to the value predetermined by the selected channel coding type (:BB:W3GP:MST:ENH:DPDC:CCOD:TYPE).	Device-specific

[SOURce<[1]|2>:]BB:W3GPP:MSTation:ENHanced:DPDCh:CCODing:TYPE  
 M12K2 | M64K | M144K | M384K | AMR

The command selects the channel coding scheme in accordance with the 3GPP specification. The channel coding scheme selected predetermines the overall symbol rate.

**Parameters:**

- M12K2**  
Measurement channel with an input data bit rate of 12.2 ksps.
- M64K**  
Measurement channel with an input data bit rate of 64 ksps.
- M144K**  
Measurement channel with an input data bit rate of 144 ksps.
- M384K**  
Measurement channel with an input data bit rate of 384 ksps.
- AMR**  
Channel coding for the AMR Coder (coding a voice channel).
- USER**  
This parameter cannot be set. USER is returned whenever a user-defined channel coding is active, that is to say, after a channel coding parameter has been changed or a user coding file has been loaded. The file is loaded by the command :BB:W3GP:BST:ENH:CHAN:DPCH:CCOD:USER:LOAD

**Example:** "BB:W3GP:MST:ENH:DPDC:CCOD:TYPE M144K"  
 'selects channel coding scheme RMC 144 kbps.

*RST value	Resolution	Options	Dependency	SCPI
M12K2	-	B10/B11 and B13 K42 SOURce2 only with second option B9/B10/B11	When channel coding is activated (:BB:W3GP:MST:ENH:DPDC:CCOD:STAT) the overall symbol rate (:BB:W3GP:MST:DPDCh:ORATe) is set to the value predetermined by the selected channel coding type.	Device-specific



**[SOURce<[1]|2>:]BB:W3GPP:MSTation:ENHanced:DPDCh:CCODing:USER:CATalog?**

The command queries existing files with stored user channel codings.  
 The files are stored with the fixed file extensions \*.3g\_ccod\_ul in a directory of the user's choice.  
 The directory applicable to the commands is defined with the command MMEMemory:CDIR.

**Example:** "MMEM:CDIR 'D:\Lists\Wcdma\CcodDpchUser'"  
 'selects the directory for the user channel coding files.  
 "BB:W3GP:MST:ENH:DPDC:CCOD:USER:CAT?"  
 'queries the existing files with user coding.  
 Response: "'user\_cc1'"  
 'there is one file with user coding.

*RST value	Resolution	Options	SCPI
-	-	B10/B11 and B13 K42 SOURce2 only with second option B9/B10/B11	Device-specific

**[SOURce<[1]|2>:]BB:W3GPP:MSTation:ENHanced:DPDCh:CCODing:USER:DELeTe <user\_coding>**

The command deletes the specified files with stored user channel codings.  
 The files are stored with the fixed file extensions \*.3g\_ccod\_ul in a directory of the user's choice.  
 The directory applicable to the commands is defined with the command MMEMemory:CDIR. To access the files in this directory, you only have to give the file name, without the path and the file extension.  
 The command triggers an event and therefore has no query form and no \*RST value.

**Example:** "MMEM:CDIR 'D:\Lists\Wcdma\CcodDpchUser'"  
 'selects the directory for the user channel coding files.  
 "BB:W3GP:MST:ENH:DPDC:CCOD:USER:DEL 'user\_cc1'"  
 'deletes the specified file with user coding.

*RST value	Resolution	Options	SCPI
-	-	B10/B11 and B13 K42 SOURce2 only with second option B9/B10/B11	Device-specific

**[SOURce<[1]2>:]BB:W3GPP:MSTation:ENHanced:DPDCh:CCODing:USER:LOAD <user\_coding>**

The command loads the specified files with stored user channel codings.

The files are stored with the fixed file extensions \*.3g\_ccod\_ul in a directory of the user's choice. The directory applicable to the commands is defined with the command MMEMoRY:CDIR. To access the files in this directory, you only have to give the file name, without the path and the file extension.

The command triggers an event and therefore has no query form and no \*RST value.

**Example:**           "MMEM:CDIR 'D:\Lists\Wcdma\CcodDpchUser'"  
                      'selects the directory for the user channel coding files.  
                      "BB:W3GP:MST:ENH:DPDC:CCOD:USER:LOAD 'user\_cc1'"  
                      'loads the specified file with user coding.

*RST value	Resolution	Options	SCPI
-	-	B10/B11 and B13 K42 SOURce2 only with second option B9/B10/B11	Device-specific

**[SOURce<[1]2>:]BB:W3GPP:MSTation:ENHanced:DPDCh:CCODing:USER:STORE <user\_coding>**

The command saves the current settings for channel coding as user channel coding in the specified file.

The files are stored with the fixed file extensions \*.3g\_ccod\_ul in a directory of the user's choice. The directory in which the file is stored is defined with the command MMEMoRY:CDIR. To store the files in this directory, you only have to give the file name, without the path and the file extension.

The command triggers an event and therefore has no query form and no \*RST value.

**Example:**           "MMEM:CDIR 'D:\Lists\Wcdma\CcodDpchUser'"  
                      'selects the directory for the user channel coding files.  
                      "BB:W3GP:MST:ENH:DPDC:CCOD:USER:STOR 'user\_cc1'"  
                      'saves the current channel coding setting in file user\_cc1 in directory  
                      D:\Lists\Wcdma\CcodDpchUser.

*RST value	Resolution	Options	SCPI
-	-	B10/B11 and B13 K42 SOURce2 only with second option B9/B10/B11	Device-specific

**[SOURCE<[1]>:]BB:W3GPp:MSTation:ENHanced:DPDCh:DERRor:BIT:LAYer**  
 TRANsport | PHYSical

The command selects the layer at which bit errors are inserted.

**Parameters: TRANsport**

Transport Layer (Layer 2). This layer is only available when channel coding is active.

**PHYSical**

Physical layer (Layer 1)

**Example:** "BB:W3GP:MST:ENH:DPDC:DERR:BIT:LAY PHYS"  
'selects layer 1 for entering bit errors.

*RST value	Resolution	Options	SCPI
PHYSical	-	B10/B11 and B13 K42 SOURCE2 only with second option B9/B10/B11	Device-specific

**[SOURCE<[1]>:]BB:W3GPp:MSTation:ENHanced:DPDCh:DERRor:BIT:RATE 1E-7 ... 5E-1**

The command sets the bit error rate.

**Example:** "BB:W3GP:MST:ENH:DPDC:DERR:BIT:RATE 1E-2"  
'sets a bit error rate of 0.01.

*RST value	Resolution	Options	SCPI
5E-3	-	B10/B11 and B13 K42 SOURCE2 only with second option B9/B10/B11	Device-specific

**[SOURCE<[1]>:]BB:W3GPp:MSTation:ENHanced:DPDCh:DERRor:BIT:STATE ON | OFF**

The command activates or deactivates bit error generation.

Bit errors are inserted into the data fields of the enhanced channels. When channel coding is active, it is possible to select the layer in which the errors are inserted (physical or transport layer). When the data source is read out, individual bits are deliberately inverted at random points in the data bit stream at the specified error rate in order to simulate an invalid signal.

**Example:** "BB:W3GP:MST:ENH:DPDC:DERR:BIT:RATE 1E-2"  
'sets a bit error rate of 0.01.

"BB:W3GP:MST:ENH:DPDC:DERR:BIT:LAY PHYS"  
'selects layer 1 for entering bit errors.

"BB:W3GP:MST:ENH:DPDC:DERR:BIT:STAT ON"  
'activates bit error generation.

*RST value	Resolution	Options	SCPI
OFF	-	B10/B11 and B13 K42 SOURCE2 only with second option B9/B10/B11	Device-specific

[SOURce<[1]|2>:]BB:W3Gpp:MSTation:ENHanced:DPDCh:DERRor:BLOCK:RATE 1E-4 ... 5E-1

The command sets the block error rate.

**Example:** "BB:W3GP:MST:ENH:DPDC:DERR:BLOC:RATE 1E-2"  
'sets the block error rate to 0.01.

*RST value	Resolution	Options	SCPI
5E-1	-	B10/B11 and B13 K42 SOURce2 only with second option B9/B10/B11	Device-specific

[SOURce<[1]|2>:]BB:W3Gpp:MSTation:ENHanced:DPDCh:DERRor:BLOCK:STATe ON | OFF

The command activates or deactivates block error generation . Block error generation is only possible when channel coding is activated.

During block error generation, the CRC checksum is determined and then the last bit is inverted at the specified error probability in order to simulate a defective signal.

**Example:** "BB:W3GP:MST:ENH:DPDC:CCOD:STAT ON"  
'activates channel coding.  
"BB:W3GP:MST:ENH:DPDC:DERR:BLOC:RATE 10E-2"  
'sets the block error rate to 0.1.  
"BB:W3GP:MST:ENH:DPDC:DERR:BLOC:STAT ON"  
'activates block error generation.

*RST value	Resolution	Options	SCPI
OFF	-	B10/B11 and B13 K42 SOURce2 only with second option B9/B10/B11	Device-specific

[SOURce<[1]|2>:]BB:W3Gpp:MSTation:ENHanced:DPDCh:DPCControl:DIRection UP | DOWN

The command selects the Dynamic Power Control direction. The selected direction determines if the channel power is increased (UP) or decreased (DOWN) by control signal with high level.

**Example:** "BB:W3GP:MST:ENH:DPDC:DPC:DIR UP"  
'selects direction up, a high level of the control signals leads to an increase of the channel power.

*RST value	Resolution	Options	SCPI
UP	-	B10/B11 and B13 K42 SOURce2 only with second option B9/B10/B11	Device-specific

[SOURce<[1]|2>:]BB:W3GPP:MSTation:ENHanced:DPDCh:DPCControl:MODE EXTernal | TPC | MANual

The command selects the Dynamic Power Control mode. The mode determines the source of the control signal.

**Example:** "BB:W3GP:MST:ENH:DPDC:DPC:MODE EXT"  
 'selects external power control. The control signal is supplied via the LEV ATT input of the AUX I/O connector (path A).

*RST value	Resolution	Options	SCPI
EXT	-	B10/B11 and B13 K42 SOURce2 only with second option B9/B10/B11	Device-specific

[SOURce<[1]|2>:]BB:W3GPP:MSTation:ENHanced:DPDCh:DPCControl[:POWER]?

The command queries the deviation of the channel power ( $\Delta$ POW) from the set power start value of the DPDCH.

The command is a query command and therefore does not have an \*RST value.

**Example:** "BB:W3GP:MST:ENH:DPDC:DPC?"  
 'queries the deviation of the channel power ( $\Delta$ POW) from the set power start value of the DPDCH.

*RST value	Resolution	Options	SCPI
-	-	B10/B11 and B13 K42 SOURce2 only with second option B9/B10/B11	Device-specific

[SOURce<[1]|2>:]BB:W3GPP:MSTation:ENHanced:DPDCh:DPCControl:RANGe:DOWN 0 ... 30 dB

The command selects the dynamic range for ranging down the channel power.

**Example:** "BB:W3GP:MST:ENH:DPDC:DPC:RANG:DOWN 20 dB"  
 'selects a dynamic range of 20 dB for ranging down the channel power.

*RST value	Resolution	Options	SCPI
10 dB	0.01 dB	B10/B11 and B13 K42 SOURce2 only with second option B9/B10/B11	Device-specific

[SOURce<[1]|2>:]BB:W3GPP:MSTation:ENHanced:DPDCh:DPCControl:RANGe:UP 0 ... 30 dB

The command selects the dynamic range for ranging up the channel power.

**Example:** "BB:W3GP:MST:ENH:DPDC:DPC:RANG:UP 20 dB"  
'selects a dynamic range of 20 dB for ranging up the channel power.

*RST value	Resolution	Options	SCPI
10 dB	0.01 dB	B10/B11 and B13 K42 SOURce2 only with second option B9/B10/B11	Device-specific

[SOURce<[1]|2>:]BB:W3GPP:MSTation:ENHanced:DPDCh:DPCControl:STATe ON | OFF

The command activates/deactivates Dynamic Power Control.

**Example:** "BB:W3GP:MST:ENH:DPDC:DPC:STAT ON"  
'activates Dynamic Power Control for the enhanced channels of UE1.

*RST value	Resolution	Options	SCPI
OFF	-	B10/B11 and B13 K42 SOURce2 only with second option B9/B10/B11	Device-specific

[SOURce<[1]|2>:]BB:W3GPP:MSTation:ENHanced:DPDCh:DPCControl:STEP[:EXTernal] 0.25 dB ... 6.0 dB

This command sets step width by which – with Dynamic Power Control being switched on - the channel power of the enhanced channels is increased or decreased.

**Example:** "BB:W3GP:MST:ENH:DPDC:DPC:DIR UP"  
'selects direction up, a high level of the control signals leads to an increase of the channel power.

"BB:W3GP:MST:ENH:DPDC:RANG:UP 10 dB"  
'selects a dynamic range of 10 dB for ranging up the channel power.

"BB:W3GP:MST:ENH:DPDC:RANG:DOWN 10 dB"  
'selects a dynamic range of 10 dB for ranging down the channel power.

"BB:W3GP:MST:ENH:DPDC:STEP 0.5 dB"  
'selects a step width of 0.5 dB. A high level of the control signal leads to an increase of 0.5 dB of the channel power, a low level to a decrease of 0.5 dB. The overall increase and decrease of channel power is limited to 10 dB each.

"BB:W3GP:MST:ENH:DPDC:DPC:MODE EXT"  
'selects external power control.

"BB:W3GP:MST:ENH:DPDC:DPC:STAT ON"  
'activates Dynamic Power Control for the enhanced channels of UE1.

*RST value	Resolution	Options	SCPI
1 dB	0.01 dB	B10/B11 and B13 K42 SOURce2 only with second option B9/B10/B11	Device-specific

[SOURce<[1]|2>:]BB:W3GPp:MSTation:ENHanced:DPDCh:DPCControl:STEP:MANual MAN1 | MAN2

This command provides the control signal for manual mode of Dynamic Power Control.

- Example:**
- "BB:W3GP:MST:ENH:DPC:DPC:DIR UP"  
'selects direction up, a high level of the control signals leads to an increase of the channel power.
  - "BB:W3GP:MST:ENH:DPC:RANG:UP 10 dB"  
'selects a dynamic range of 10 dB for ranging up the channel power.
  - "BB:W3GP:MST:ENH:DPC:RANG:DOWN 10 dB"  
'selects a dynamic range of 10 dB for ranging down the channel power.
  - "BB:W3GP:MST:ENH:DPC:STEP 0.5 dB"  
'selects a step width of 0.5 dB. A high level of the control signal leads to an increase of 0.5 dB of the channel power, a low level to a decrease of 0.5 dB. The overall increase and decrease of channel power is limited to 10 dB each.
  - "BB:W3GP:MST:ENH:DPDC:DPC:MODE MAN"  
'selects manual power control.
  - "BB:W3GP:MST:ENH:DPDC:DPC:STAT ON"  
'activates Dynamic Power Control for the enhanced channels of UE1.
  - "BB:W3GP:MST:ENH:DPDC:DPC:STEP:MAN MAN0"  
'decreases the level by 0.5 dB.

*RST value	Resolution	Options	SCPI
MAN1		B10/B11 and B13 K42 SOURce2 only with second option B9/B10/B11	Device-specific

[SOURce<[1]|2>:]BB:W3GPp:MSTation:ENHanced:DPDCh:INTerleaver2 ON | OFF

The command activates or deactivates channel coding interleaver state 2 for all the transport channels.

Interleaver state 1 can be activated and deactivated for each channel individually  
(:BB:W3GPp:MST[1]:ENHanced:DPDCh:TChannel<n>:INTerleaver[1])

**Note:**

*The interleaver states do not cause the symbol rate to change*

- Example:**
- "BB:W3GP:MST:ENH:DPDC:INT2 OFF"  
'deactivates channel coding interleaver state 2 for all the transport channels.

*RST value	Resolution	Options	SCPI
ON	-	B10/B11 and B13 K42 SOURce2 only with second option B9/B10/B11	Device-specific

**[SOURce<[1]>:]BB:W3GPP:MSTation:ENHanced:DPDCh:ORATe?**

The command queries the overall symbol rate (Overall Symbol Rate) of the enhanced channels. The value is set with the command :SOURce:BB:W3GPP:MSTation1:DPDCh:ORATe. This setting also defines the number of active channels, their symbol rates and channelization codes.

The command is a query command and therefore does not have an \*RST value.

**Example:** "BB:W3GP:MST:ENH:DPDC:ORAT?"  
 'queries the overall symbol rate of the DPDCH of user equipment 1.

*RST value	Resolution	Options	SCPI
-	-	B10/B11 and B13 K42 SOURce2 only with second option B9/B10/B11	Device-specific

**[SOURce<[1]>:]BB:W3GPP:MSTation:ENHanced:DPDCh:TCHannel<0|[1]...6>:CRCSize**

NONE | 8 | 12 | 16 | 24

The command defines the CRC length for the selected transport channel. It is also possible to deactivate checksum determination.

**Note:**

*The transport channel designations for remote control are TCHannel0 for DCCH, TCHannel1 to TCHannel6 for DTCH1 to DTCH6.*

**Example:** "BB:W3GP:MST:ENH:DPDC:TCH:CRCS NONE"  
 'deactivates checksum determination for DTCH1.

*RST value	Resolution	Options	SCPI
12	-	B10/B11 and B13 K42 SOURce2 only with second option B9/B10/B11	Device-specific



[SOURCE<[1]|2>:]BB:W3GPP:MSTation:ENHanced:DPDCh:TCHannel<0|[1]...6>:DATA  
 PN9 | PN11 | PN15 | PN16 | PN20 | PN21 | PN23 | DLISt | ZERO | ONE | PATTErn

The command determines the data source for the data fields of the transport channels of enhanced channels with channel coding. If channel coding is not active, the data source is selected with the command :BB:W3GP:MST:CHANnel<n>:DPDCh:DATA. Also applicable for the DCCH is the command :BB:W3GPP:MST:CHANnel1:DPDCh:DATA:DCCH.

**Note:**

The transport channel designations for remote control are TCHannel0 for DCCH, TCHannel1 to TCHannel6 for DTCH1 to DTCH6.

**Parameters:****PNxx**

The pseudo-random sequence generator is used as the data source. Different random sequence lengths can be selected.

**DLISt**

A data list is used. The data list is selected with the command  
 W3GPP:MST:ENH:TCH:DATA:DSEL.

**ZERO | ONE**

Internal 0 and 1 data is used.

**PATTErn**

Internal data is used. The bit pattern for the data is defined by the command  
 SOURCE:BB:W3GP:MST:ENH:DPDC:TCH<n>:DATA:PATT

**Example:**

"BB:W3GP:MST:ENH:DPDC:TCH2:DATA PATT"  
 'selects as the data source for the data fields of DTCH2 of user equipment 1, the bit pattern defined with the following command.  
 "BB:W3GP:MST:ENH:DPDC:TCH2:DATA:PATT #H3F, 8"  
 'defines the bit pattern.

*RST value	Resolution	Options	SCPI
PN9	-	B10/B11 and B13 K42 SOURCE2 only with second option B9/B10/B11	Device-specific

[SOURCE<[1]|2>:]BB:W3GPP:MSTation:ENHanced:DPDCh:TCHannel<0|[1]...6>:DATA:PATTERn  
 #B0,1 ... #B11..1,64

The command determines the bit pattern for the PATTErn data source selection for transport channels.

**Note:**

The transport channel designations for remote control are TCHannel0 for DCCH, TCHannel1 to TCHannel6 for DTCH1 to DTCH6.

**Example:**

"BB:W3GP:MST:ENH:DPDC:TCH0:DATA:PATT #H3F, 8"  
 'defines the bit pattern for DCCH.

*RST value	Resolution	Options	SCPI
#H0, 1	-	B10/B11 and B13 K42 SOURCE2 only with second option B9/B10/B11	Device-specific

[SOURce<[1]>:]BB:W3GPP:MSTation:ENHanced:DPDCh:TCHannel<0|[1]...6>:DATA:DSElect <data list name>

The command selects the data list for the enhanced channels for the DLIS selection.

The files are stored with the fixed file extensions \*.dm\_iqd in a directory of the user's choice. The directory applicable to the commands is defined with the command `MMEMory:CDIR`. To access the files in this directory, you only have to give the file name, without the path and the file extension.

**Note:**

The transport channel designations for remote control are *TCHannel0* for DCCH, *TCHannel1* to *TCHannel6* for DTCH1 to DTCH6.

**Example:**

```
"BB:W3GP:MST:ENH:DPDC:TCH1:DATA DLIS"
'selects the Data Lists data source.

"MMEM:CDIR 'D:\Lists\Dm\IQData'"
'selects the directory for the data lists.

"BB:W3GP:MST:ENH:DPDC:TCH1:DATA:DSEL 'TCH1'"
'selects the file 'tch1' as the data source.
```

*RST value	Resolution	Options	SCPI
-	-	B10/B11 and B13 K42 SOURce2 only with second option B9/B10/B11	Device-specific

[SOURce<[1]>:]BB:W3GPP:MSTation:ENHanced:DPDCh:TCHannel<0|[1]...6>:EPRotection NONE | TURBo3 | CON2 | CON3

The command determines the error protection

**Note:**

The transport channel designations for remote control are *TCHannel0* for DCCH, *TCHannel1* to *TCHannel6* for DTCH1 to DTCH6.

**Parameters:**

- NONE**  
No error protection.
- TURBo3**  
Turbo Coder of rate 1/3 in accordance with the 3GPP specifications.
- CON2 | CON3**  
Convolution Coder of rate 1/2 or 1/3 with generator polynomials defined by 3GPP.

**Example:**

```
"BB:W3GP:MST:ENH:DPDC:TCH1:EPR NONE"
'error protection is deactivated.
```

*RST value	Resolution	Options	SCPI
CON1/3	-	B10/B11 and B13 K42 SOURce2 only with second option B9/B10/B11	Device-specific

[SOURce<[1]2>:]BB:W3GPp:MSTation:ENHanced:DPDCh:TCHannel<0|[1]...6>:INTerleaver[1] ON | OFF

The command activates or deactivates channel coding interleaver state 1 for the selected channel. Interleaver state 1 can be activated and deactivated for each channel individually. The channel is selected via the suffix at TCHannel.

Interleaver state 2 can only be activated or deactivated for all the channels together (:BB:W3GP:MSTation:ENHanced:INTerleaver2).

**Note:**

The interleaver states do not cause the symbol rate to change.  
The transport channel designations for remote control are TCHannel0 for DCCH, TCHannel1 to TCHannel6 for DTCH1 to DTCH6.

**Example:** "BB:W3GP:MST:ENH:DPDC:TCH5:INT1 OFF"  
'deactivates channel coding interleaver state 1 for TCH 5.

*RST value	Resolution	Options	SCPI
ON	-	B10/B11 and B13 K42 SOURce2 only with second option B9/B10/B11	Device-specific

[SOURce<[1]2>:]BB:W3GPp:MSTation:ENHanced:DPDCh:TCHannel<0|[1]...6>:RMATtribute 16...1024

The command sets data rate matching (Rate Matching).

**Note:**

The transport channel designations for remote control are TCHannel0 for DCCH, TCHannel1 to TCHannel6 for DTCH1 to DTCH6.

**Example:** "BB:W3GP:MST:ENH:DPDC:TCH:RMAT 1024"  
'sets rate matching to 1024 for DTCH1.

*RST value	Resolution	Options	SCPI
256	-	B10/B11 and B13 K42 SOURce2 only with second option B9/B10/B11	Device-specific

[SOURce<[1]|2>:]BB:W3Gpp:MSTation:ENHanced:DPDCh:TCHannel<0|[1]...6>:STATe ON|OFF

The command activates/deactivates the selected transport channel.

**Note:**

The transport channel designations for remote control are TCHannel0 for DCCH, TCHannel1 to TCHannel6 for DTCH1 to DTCH6.

**Example:** "BB:W3GP:MST:ENH:DPDC:TCH1:STAT"  
'activates DTCH1.

*RST value	Resolution	Options	SCPI
OFF	1	B10/B11 and B13 K42 SOURce2 only with second option B9/B10/B11	Device-specific

[SOURce<[1]|2>:]BB:W3Gpp:MSTation:ENHanced:DPDCh:TCHannel<0|[1]...6>:TBCount 1 ... 16

The command sets the transport block count.

**Note:**

The transport channel designations for manual operation and remote control are different: TCHannel1 designates DCCH, TCHannel2 to TCHannel7, DTCH1 to DTCH6.

**Example:** "BB:W3GP:MST:ENH:DPDC:TCH2:TBC 4"  
'activates 4 transport blocks for DTCH1.

*RST value	Resolution	Options	SCPI
1	-	B10/B11 and B13 K42 SOURce2 only with second option B9/B10/B11	Device-specific

[SOURce<[1]|2>:]BB:W3Gpp:MSTation:ENHanced:DPDCh:TCHannel<0|[1]...6>:TBSize 0 - 4096

The command sets the size of the data blocks.

**Example:** "BB:W3GP:MST:ENH:DPDC:TCH2:TBS 1024"  
'sets the length of the transport blocks for DTCH2 to 1024.

*RST value	Resolution	Options	SCPI
100	-	B10/B11 and B13 K42 SOURce2 only with second option B9/B10/B11	Device-specific

**[SOURce<[1]|2>:]BB:W3GPp:MSTation:ENHanced:DPDCh:TCHannel<0|[1]...6>:TTINterval**  
 10MS | 20MS | 40MS | 80MS

The command sets the number of frames into which a TCH is divided. This setting also defines the interleaver depth.

**Note:**

The transport channel designations for remote control are TCHannel0 for DCCH, TCHannel1 to TCHannel6 for DTCH1 to DTCH6.

**Example:**           "BB:W3GP:MST:ENH:DPDC:TCH2:TTIN 20ms"  
                           'sets that the transport channel is divided into 2 frames.

*RST value	Resolution	Options	SCPI
10MS	-	B10/B11 and B13 K42 SOURce2 only with second option B9/B10/B11	Device-specific

**[SOURce<[1]|2>:]BB:W3GPp:MSTation:ENHanced:PCPCh:CCODing:STATe** ON | OFF

The command activates or deactivates channel coding for the PCPCH.

**Example:**           "BB:W3GP:MST:ENH:PCPC:CCOD:TYPE TB168"  
                           'selects channel coding type CPCH RMC (TB size 168 bits).

"BB:W3GP:MST:ENH:PCPC:CCOD:STAT ON"  
                           'activates channel coding.

*RST value	Resolution	Options	Dependencies	SCPI
OFF	-	B10/B11 and B13 K42 SOURce2 only with second option B9/B10/B11	When channel coding is active, the symbol rate is limited to the range between 15 and 120 ksps. Values above this limit are automatically set to 120 ksps.	Device-specific

[SOURce<[1]>:]BB:W3GPP:MSTation:ENHanced:PCPCh:CCODing:TYPE TB168 | TB360

The command selects the channel coding scheme in accordance with the 3GPP specification.

**Parameters:**     **TB168**  
                  CPCCH RMC (TB size 168 bits)

**TB360**  
                  CPCCH RMC (TB size 360 bits)

**Example:**       "BB:W3GP:MST:ENH:PCPC:CCOD:TYPE TB168"  
                  'selects channel coding scheme RMC 168 bits.

*RST value	Resolution	Options	SCPI
TB168	-	B10/B11 and B13 K42 SOURce2 only with second option B9/B10/B11	Device-specific

[SOURce<[1]>:]BB:W3GPP:MSTation:ENHanced:PRACH:CCODing:STATE ON | OFF

The command activates or deactivates channel coding for the PRACH.

**Example:**       "BB:W3GP:MST:ENH:PRAC:CCOD:TYPE TB168"  
                  'selects channel coding type RACH RMC (TB size 168 bits).

                  "BB:W3GP:MST:ENH:PRAC:CCOD:STAT ON"  
                  'activates channel coding.

*RST value	Resolution	Options	SCPI
OFF	-	B10/B11 and B13 K42 SOURce2 only with second option B9/B10/B11	Device-specific

[SOURce<[1]>:]BB:W3GPP:MSTation:ENHanced:PRACH:CCODing:TYPE TB168 | TB360

The command selects the channel coding scheme in accordance with the 3GPP specification.

**Parameters:**     **TB168**  
                  RACH RMC (TB size 168 bits)

**TB360**  
                  RACH RMC (TB size 360 bits)

**Example:**       "BB:W3GP:MST:ENH:PRAC:CCOD:TYPE TB168"  
                  'selects channel coding scheme RMC 168 bits.

*RST value	Resolution	Options	SCPI
TB168	-	B10/B11 and B13 K42 SOURce2 only with second option B9/B10/B11	Device-specific

## SOURce:W3GPP - TS25141 - Test Wizard

The signal generator gives you the opportunity to generate predefined settings which enable tests on base stations in conformance with the 3G Standard 3GPP-FDD. It offers a selection of predefined settings according to Test Cases in TS 25.141. The settings take effect only after execution of command [SOURce:]BB:W3GPP:TS25141:TCASe:EXECute.

The test setups and equipment requirements for each Test Case are described in Chapter 4, Section "Tests on Base Stations in Conformance with the 3 G Standard 3GPP-FDD".

Unlike most of the other commands of the SOURce:W3GPP-Subsystem, key word SOURce is without Suffix. Signal routing is possible only for Test Cases that do not use diversity and is performed via command :SOURce:BB:W3GPP:TS25141:ROUte.

Command	Parameter	Default unit	Comment
[SOURce:]BB:W3GPP:TS25141:AWGN:CNRatio	-40.0 dB ... 40.0 dB	dB	
[SOURce:]BB:W3GPP:TS25141:AWGN:ENRatio	-80.0 dB .. 80.0 dB	dB	
[SOURce:]BB:W3GPP:TS25141:AWGN:POWer:NOISe	Wanted Signal Level - C/N	dB	
[SOURce:]BB:W3GPP:TS25141:AWGN:RBLock:RATE	B0 (=0.0)   B01 (=0.1)   B001 (=0.01)   B0001 (=0.001)		
[SOURce:]BB:W3GPP:TS25141:AWGN:RPDection:RATE	PD099   PD0999		
[SOURce:]BB:W3GPP:TS25141:AWGN:STATe	ON   OFF		
[SOURce:]BB:W3GPP:TS25141:BSPClass	WIDE   MEdium   LOCal		
[SOURce:]BB:W3GPP:TS25141:BSSignal:FREQuency	100.0 kHz ... 6.0 GHz		
[SOURce:]BB:W3GPP:TS25141:BSSignal:POWer	-145.0 dBm ... 20.0 dBm	dBm	
[SOURce:]BB:W3GPP:TS25141:EMODe	STANdard   USER		
[SOURce:]BB:W3GPP:TS25141:IFSignal:BWIDth	WIDE   NARRow		
[SOURce:]BB:W3GPP:TS25141:IFSignal:CNRatio	-80.0 ... 80.0 dB	dB	
[SOURce:]BB:W3GPP:TS25141:IFSignal:CW:FOFFset	-40.0 MHz ... 40.0 MHz	Hz	
[SOURce:]BB:W3GPP:TS25141:IFSignal:CW:POWer	-145.0 dBm .. 20.0 dBm	dBm	
[SOURce:]BB:W3GPP:TS25141:IFSignal:CW:STATe	ON   OFF		
[SOURce:]BB:W3GPP:TS25141:IFSignal:FOFFset	-40.0 MHz ... 40.0 MHz	Hz	
[SOURce:]BB:W3GPP:TS25141:IFSignal:MODulated:FOFFset	-40.0 MHz .. 40.0 MHz	Hz	
[SOURce:]BB:W3GPP:TS25141:IFSignal:MODulated:POWer	-145.0 dBm ... 20.0 dBm	dBm	
[SOURce:]BB:W3GPP:TS25141:IFSignal:MODulated:STATe	ON   OFF		

Command	Parameter	Default unit	Comment
[SOURce:]BB:W3GPP:TS25141:IFSignal:MODulated:TYPE	WCDMA   GMSK   CW   QPSK		
[SOURce:]BB:W3GPP:TS25141:IFSignal:POWer	-145.0 .. 20.0 dBm	dBm	
[SOURce:]BB:W3GPP:TS25141:IFSignal:SETTing:TMOdel:BSTation	TM164   TM116   TM132   TM2   TM316   TM332   TM4   TM538   TM528   TM58		
[SOURce:]BB:W3GPP:TS25141:IFSignal:STATe	ON   OFF		
[SOURce:]BB:W3GPP:TS25141:IFSignal:TYPE	WCDMA   GMSK   CW   QPSK		
[SOURce:]BB:W3GPP:TS25141:ROUte	A   B		
[SOURce:]BB:W3GPP:TS25141:RXDiversity	OFF   ON		
[SOURce:]BB:W3GPP:TS25141:SCODE	0x0 .. 0xFFFF FF (24 bits)		
[SOURce:]BB:W3GPP:TS25141:SCODE:MODE	OFF   LONG   SHORT		
[SOURce:]BB:W3GPP:TS25141:TCASe	TC642   TC66   TC72   TC73   TC74   TC75   TC76   TC78   TC821   TC86   TC881   TC883   TC891   TC893		
[SOURce:]BB:W3GPP:TS25141:TCASe:EXECute			No query
[SOURce:]BB:W3GPP:TS25141:TRIGger	AUTO   PRESet		
[SOURce:]BB:W3GPP:TS25141:TRIGger:OUTPut	AUTO   PRESet		
[SOURce:]BB:W3GPP:TS25141:WSIGnal:BTYPe	WIDE   COlocated   NARRow		
[SOURce:]BB:W3GPP:TS25141:WSIGnal:DCRatio	-80.0 dB .. 80.0 dB	dB	
[SOURce:]BB:W3GPP:TS25141:WSIGnal:DPCCh:SFORmat	0 ... 5		
[SOURce:]BB:W3GPP:TS25141:WSIGnal:DPCCh:TPC:RDATa	AGGRegated   DLISt   ONE   SINGle   ZERO		
[SOURce:]BB:W3GPP:TS25141:WSIGnal:DPCCh:TPC:RDATa:DSElect	<data_list>		
[SOURce:]BB:W3GPP:TS25141:WSIGnal:DPCCh:TPC:RDATa:PATtern	#B0,1...#B11..1,64		
[SOURce:]BB:W3GPP:TS25141:WSIGnal:DPCCh:TPC:SDATa	PMAxlessnsteps   DLISt		
[SOURce:]BB:W3GPP:TS25141:WSIGnal:DPCCh:TPC:SDATa:DSElect	<data_list>		
[SOURce:]BB:W3GPP:TS25141:WSIGnal:DPCCh:TPC:SDATa:PDSTeps	1 ... 1000		
[SOURce:]BB:W3GPP:TS25141:WSIGnal:DPCCh:TPC:SDATa:PUSTeps	1 ... 1000		
[SOURce:]BB:W3GPP:TS25141:WSIGnal:DPDCh:DERRor:BIT:RATE	0.0 ... 0.1		
[SOURce:]BB:W3GPP:TS25141:WSIGnal:DPDCh:DERRor:BLOCK:RATE	0.0 ... 0.1		
[SOURce:]BB:W3GPP:TS25141:WSIGnal:DPDCh:CCODing:TYPE	M12K2   M64K   M144k   M384k   AMR		



Command	Parameter	Default unit	Comment
[SOURce:]BB:W3GPp:TS25141:WSIGnal:DPDCh:ORATe	D7K5   D15K   D30K   D60K   D120k   D240k   D480k   D960k   D1920k   D2880k   D3840k   D4800k   D5760k		
[SOURce:]BB:W3GPp:TS25141:WSIGnal:FREQUency	100.0 kHz ... 6.0 GHz	Hz	
[SOURce:]BB:W3GPp:TS25141:WSIGnal:OBANd	I   II   III   IV   V		
[SOURce:]BB:W3GPp:TS25141:WSIGnal:PCPCh:CCODing:TYPE	TB168   TB360		
[SOURce:]BB:W3GPp:TS25141:WSIGnal:POWEr	-145.0 dBm ... 20.0 dBm	dBm	
[SOURce:]BB:W3GPp:TS25141:WSIGnal:PRACH:CCODing:TYPE	TB168   TB360		
[SOURce:]BB:W3GPp:TS25141:WSIGnal:STATe	ON   OFF		
[SOURce:]BB:W3GPp:TS25141:WSIGnal:TRIGger[:EXTernal]:DELay	0.0 ... 65535.0 chips		

**[SOURce:]BB:W3GPp:TS25141:AWGN:CNRatio -40.0 dB ... 40.0 dB**

This command sets the carrier/noise ratio in mode **"User definable"** (:SOURce:BB:W3GPp:TS25141:EMODE USER). It is query only in mode **"According to Standard"** (:SOURce:BB:W3GPp:TS25141:EMODE STANdard).

**Example:** "BB:W3GP:TS25141:TCAS TC73"  
'selects test case 7.3.

"BB:W3GP:TS25141:EMOD STAN"  
'selects mode "According to Standard". Only settings in compliance with the standard can be made.

"BB:W3GP:TS25141:AWGN:CNR?"  
'queries the signal/noise ratio of the interfering signal.

Response: "-16.80"  
'the signal/noise ratio of the interfering signal is -16.8 dB.

*RST value	Resolution	Options	Dependencies	SCPI
-16.8 dB	0.01 dB	Test Cases 7.3, 8.x (not 8.6) minimum requirement: Options B13, B9/B10/B11, K42 and K62  For additionally required options see selected test case	Sets command :SOURce1 2:AWGN:CNR after execution of :SOURce:BB:W3GP:TS25141:TCAS:EXECute	Device-specific

[SOURce:]BB:W3GPP:TS25141:AWGN:ENRatio -80.0 dB .. 80.0 dB

This command sets the ratio of bit energy to noise power density in mode "User definable" (:SOURce:BB:W3GPP: TS25141:EMODE USER). It is query only in mode "According to Standard" (:SOURce:BB:W3GPP:TS25141:EMODE STANdard).

**Example:** "BB:W3GP:TS25141:TCAS TC821"  
 'selects test case 8.2.1.

"BB:W3GP:TS25141:EMOD STAN"  
 'selects mode "According to Standard". Only settings in compliance with the standard can be made.

"BB:W3GP:TS25141:AWGN:ENR?"  
 'queries the ratio of bit energy to noise power density of the interfering signal.

Response: "8.70"  
 'the E/N ratio of the interfering signal is 8.7 dB.

RST value	Resolution	Options	Dependencies	SCPI
8.7 dB	0.01 dB	Test Cases 8.x (not 8.6) minimum requirement: Options B13, B9/B10/B11, K42 and K62  For additionally required options see selected test case	Sets command :SOURce1 2:AWGN:ENR after execution of :SOURce:BB:W3GP:TS25141:TCASe:EXECute	Device-specific

[SOURce:]BB:W3GPP:TS25141:AWGN:POWER:NOISe wanted signal level - C/N

This command sets the noise level in mode "User definable" (:SOURce:BB:W3GPP:TS25141:EMODE USER). It is query only in mode "According to Standard" (:SOURce:BB:W3GPP:TS25141:EMODE STANdard).

**Example:** "BB:W3GP:TS25141:TCAS TC73"  
 'selects test case 7.3.

"BB:W3GP:TS25141:EMOD STAN"  
 'selects mode "According to Standard". Only settings in compliance with the standard can be made.

"BB:W3GP:TS25141:AWGN:POW:NOIS?"  
 'queries the noise level of the interfering signal.

Response: "-73"  
 'the noise level of the interfering signal is -73 dB.

RST value	Resolution	Options	Dependencies	SCPI
Depending on the selected test case	0.1 dB	Test Cases 7.3, 8.x (not 8.6) minimum requirement: Options B13, B9/B10/B11, K42 and K62  For additionally required options see selected test case	Sets command :SOURce1 2:AWGN:POW:NOISe after execution of :SOURce:BB:W3GP:TS25141:TCASe:EXECute	Device-specific

**[SOURce:]BB:W3GPp:TS25141:AWGN:RBLock:RATE B0 | B01 | B001 | B0001**

This command sets the required block error rate in edit mode 'According to Standard' (:SOURce:BB:W3GPp:TS25141:EMODe STANdard).

**Example:** "BB:W3GP:TS25141:TCAS TC893"  
'selects test case 8.9.3.

"BB:W3GP:TS25141:EMOD STAN"  
'selects mode "According to Standard". Only settings in compliance with the standard can be made.

"BB:W3GP:TS25141:AWGN:RBL:RATE B01"  
'sets the required block error rate to < 0.01.

*RST value	Resolution	Options	SCPI
B001	-	Test Cases 8.x (, not 8.6, 8.8.1, 8.9.1), minimum requirement: Options B13, B9/B10/B11, K42 and K62  For additionally required options see selected test case	Device-specific

**[SOURce:]BB:W3GPp:TS25141:AWGN:RPDetection:RATE PD099 | PD0999**

This command sets the required probability of detection of preamble (Pd) in edit mode 'According to Standard' (:SOURce:BB:W3GPp:TS25141:EMODe STANdard). The selection determines the ratio  $E_p/N_0$ .

**Example:** "BB:W3GP:TS25141:TCAS TC891"  
'selects test case 8.9.1.

"BB:W3GP:TS25141:EMOD STAN"  
'selects mode "According to Standard". Only settings in compliance with the standard can be made.

"BB:W3GP:TS25141:AWGN:RPD:RATE PD099"  
'sets the required probability of detection of preamble to > 0.99.

*RST value	Resolution	Options	SCPI
PD099	-	Test Cases 8.8.1, 8.9.1 minimum requirement: Options B13, B9/B10/B11, K42 and K62  For additionally required options see selected test case	Device-specific

[SOURce:]BB:W3GPP:TS25141:AWGN:STATe ON | OFF

This command enables/disables the generation of the AWGN signal in mode 'User Definable'. In mode 'According to Standard' the state is fixed to 'ON'.

**Example:** "BB:W3GP:TS25141:TCAS TC892"  
'selects test case 8.9.2.

"BB:W3GP:TS25141:EMOD USER"  
'selects mode "User definable". Also settings that are not in compliance with the standard can be made.

"BB:W3GP:TS25141:AWGN:STAT OFF"  
'disables the generation of the AWGN signal.

*RST value	Resolution	Options	Dependencies	SCPI
ON	-	Test Cases 7.3, 8.x (not 8.6) minimum requirement: Options B13, B9/B10/B11, K42 and K62  For additionally required options see selected test case	Sets command :SOURce1 2:AWGN:STATe after execution of :SOURce:BB:W3GP:TS25141:TCASe:EXECute	Device-specific

[SOURce:]BB:W3GPP:TS25141:BSPClass WIDE | MEDium | LOCal

This command enters the base station power class in mode "According to Standard" (:SOURce:BB:W3GPP:TS25141:EMODE STANDard). The selected power class determines the output level of the signal generator. For edit mode "User Definable" (:SOURce:BB:W3GPP:TS25141:EMODE USER), the output level can be set with command :SOURce:BB:W3GPP:TS25141:WSIGnal:POWer.

**Example:** "BB:W3GP:TS25141:BSPC WIDE"  
'the base station under test is a wide area base station.

*RST value	Resolution	Options	Dependencies	SCPI
ON	-	All test cases except for 6.6 minimum requirement: Options B13, B9/B10/B11 and K42  For additionally required options see selected test case	Sets the power commands associated with the selected test case (e.g. :SOURce1 2:POWer) after execution of :SOURce:BB:W3GP:TS25141:TCASe:EXECute	Device-specific

[SOURce:]BB:W3GPP:TS25141:BSSignal:FREQUency 100.0 kHz ... 6.0 GHz

This command enters the RF frequency of the base station.

**Example:** "BB:W3GP:TS25141:BSS:FREQ 1GHz"  
'the frequency of the base station under test is 1 GHz.

*RST value	Resolution	Options	SCPI
1 GHz	-	Test case 6.6 Options B13, B9/B10/B11 and K42	Device-specific

[SOURce:]BB:W3GPp:TS25141:BSSignal:POWer -145.0 dBm ... 20.0 dBm

This command enters the RF power of the base station.

**Example:** "BB:W3GP:TS25141:TCAS TC66"  
'selects test case 6.6.

"BB:W3GP:TS25141:BSS:POW -30"  
'the power of the base station under test is -30 dBm.

*RST value	Resolution	Options	SCPI
-30 dBm	0.0 dBm	Test case 6.6 Options B13, B9/B10/B11 and K42	Device-specific

[SOURce:]BB:W3GPp:TS25141:EMODE STANDard | USER

This command selects the edit mode for the configuration of the test cases.).

**Parameter: STANDard**  
Edit mode "**According to Standard**". Only settings in compliance with TS 25.141 are possible. All other parameters are preset.

**USER**  
Edit mode "**User definable**". A wider range of settings is possible.

**Example:** "BB:W3GP:TS25141:EMOD USER"  
'selects edit mode "**User definable**".

*RST value	Resolution	Options	SCPI
STANdard	-	All test cases minimum requirement: Options B13, B9/B10/B11 and K42 For additionally required options see selected test case	Device-specific

**SOURce:]BB:W3GPP:TS25141:IFSignal:BWIDth WIDE | NARRow**

This command selects the interferer scenario.

**Parameter:**       **WIDE**

A 3GPP FDD uplink interfering signal is generated for path B. In "**According to Standard**" mode, the 3GPP FDD uplink interfering signal is superimposed by a CW interfering signal with a frequency of 10 MHz and a level of -48 dB.

**NARROW**

A GMSK interfering signal (3.84 MHz bandwidth, root cosine filter 0.22, PRBS9 data source) is generated for path B. In "**According to Standard**" mode, the GMSK interfering signal is superimposed by a CW interfering signal with a frequency of 3.5 MHz and a level of -47 dB.

**Example:**       "BB:W3GP:TS25141:TCAS TC76"

'selects test case 7.6.

"BB:W3GP:TS25141:IFS:BWID WIDE"

'selects a 3GPP FDD uplink interfering signal 1.

*RST value	Resolution	Options	SCPI
WIDE	-	Test Case 7.6 Option K62 and B20x, two options B13, B9/B10/B11, and K42 each	Device-specific

**[SOURce:]BB:W3GPP:TS25141:IFSignal:CNRatio -80.0 ... 80.0 dB**

This command sets the power ratio of wanted signal to interfering signal for test case 7.4 in mode "**User definable**" (:SOURce:BB:W3GPP: TS25141:EMODE USER). It is query only in mode "**According to Standard**" (:SOURce:BB:W3GPP:TS25141:EMODE STANdard).

This command sets the power ratio of interfering signal to wanted signal for test case 6.6 in mode "**User definable**" (:SOURce:BB:W3GPP: TS25141:EMODE USER). It is query only in mode "**According to Standard**" (:SOURce:BB:W3GPP:TS25141:EMODE STANdard).

**Example:**       "BB:W3GP:TS25141:TCAS TC74"

'selects test case 7.4.

"BB:W3GP:TS25141:EMOD STAN"

'selects mode "**According to Standard**". Only settings in compliance with the standard can be made.

"BB:W3GP:TS25141:IFS:CNR?"

'queries the power ratio.

Response: "-63.0"

'the signal/noise ratio of the interfering signal is -63 dB.

*RST value	Resolution	Options	Dependencies	SCPI
-63 dB	0.01 dB	Test case 6.6 Options B13, B9/B10/B11 and K42 Test case 7.4 Options B13, B9/B10/B11, B20x , and two options K42	Sets command :SOURce2:POWer after execution of :SOURce:BB:W3GP:TS25141:TCASe:EXECute	Device-specific

**SOURce:]BB:W3GPP:TS25141:IFSignal:CW:FOFFset -40.0 MHz ... 40.0 MHz**

This command sets frequency offset of the CW interfering signal versus the wanted signal RF frequency. In mode **"According to Standard"** (:SOURce:BB:W3GPP:TS25141:EMODE STANdard) the frequency offset value is fixed to a value determined by the selected **Interferer Bandwidth** (:SOURce:BB:W3GPP:TS25141:IFS:BWIDth).

**Example:** "BB:W3GP:TS25141:TCAS TC76"  
'selects test case 7.6.

"BB:W3GP:TS25141:EMOD STAN"  
'selects mode **"According to Standard"**. Only settings in compliance with the standard can be made.

"BB:W3GP:TS25141:IFS:IFS:BWID WIDE"  
'selects interferer scenario wideband.

"BB:W3GP:TS25141:IFS:CW:FOFF?" '  
queries the frequency offset of the CW interferer.

Response: "10000000"  
'the frequency offset is 10 MHz.

*RST value	Resolution	Options	Dependencies	SCPI
10 MHz	0.01 Hz	Test Case 7.6 Options B20x and K62, second option B10/B11 and B13 each, two options K42.	Sets commands :SOURce2:FREQ, :SOURce2:BB:FOFF and :SOURce2:AWGN:FREQ:TARGet after execution of :SOURce:BB:W3GP:TS25141:TCAS:EXEC	Device-specific

**[SOURce:]BB:W3GPP:TS25141:IFSignal:CW:POWER -145.0 dBm ... 20.0 dBm**

This command sets the RF level of the CW interfering signal. In mode **"According to Standard"** (:SOURce:BB:W3GPP:TS25141:EMODE STANdard) the RF level value is fixed to a value determined by the selected **Interferer Bandwidth** (:SOURce:BB:W3GPP:TS25141:IFS:BWIDth).

**Example:** "BB:W3GP:TS25141:TCAS TC76"  
'selects test case 7.6.

"BB:W3GP:TS25141:EMOD STAN"  
'selects mode **"According to Standard"**. Only settings in compliance with the standard can be made.

"BB:W3GP:TS25141:IFS:BWID NARR"  
'selects interferer scenario narrowband.

"BB:W3GP:TS25141:IFS:CW:POW?" '  
'queries the RF level of the CW interferer.

Response: "-47"  
'the RF level is -47.00 dBm.

*RST value	Resolution	Options	Dependencies	SCPI
-48 dBm	0.01 dBm	Test Case 7.6 Options B20x and K62, two options B10/B11, B13, two options and K42 each.	Sets commands :SOURce2:AWGN:CNRatio and :SOURce2:AWGN:POWER:NOISe after execution of :SOURce:BB:W3GP:TS25141:TCAS:EXEC	Device-specific

[SOURce:]BB:W3GPP:TS25141:IFSignal:CW:STATe ON | OFF

This command enable/disables the CW interfering signal. In mode "**According to Standard**" (:SOURce:BB:W3GPP:TS25141:EMODE STANDard) the value is fixed to "ON".

**Example:** "BB:W3GP:TS25141:TCAS TC76"  
'selects test case 7.6.

"BB:W3GP:TS25141:EMOD STAN"  
'selects mode "**According to Standard**". Only settings in compliance with the standard can be made.

"BB:W3GP:TS25141:IFS:BWID NARR"  
'selects interferer scenario narrowband.

"BB:W3GP:TS25141:IFS:CW:STAT?"  
'queries the state of the CW interferer.

Response: "1"  
'the CW interferer is enabled.

*RST value	Resolution	Options	Dependencies	SCPI
-48 dBm	0.01 dBm	Test Case 7.6 Options B20x and K62, second option B10/B11 and B13 each, two options K42.	Sets commands :SOURce2:AWGN:CNRatio and :SOURce2:AWGN:Power:NOISe after execution of :SOURce:BB:W3GP:TS25141:TCAS:EXEC	Device-specific

[SOURce:]BB:W3GPP:TS25141:IFSignal:FOFFset -40.0 MHz ... 40.0 MHz

This command sets frequency offset of the interfering signal versus the wanted signal RF frequency. For test case 7.4, the choice is limited to +/- 5MHz in mode "**According to Standard**" (:SOURce:BB:W3GPP:TS25141:EMODE STANDard).

**Example:** "BB:W3GP:TS25141:TCAS TC74"  
'selects test case 7.4.

"BB:W3GP:TS25141:EMOD STAN"  
'selects mode "**According to Standard**". Only settings in compliance with the standard can be made.

"BB:W3GP:TS25141:IFS:FOFF 0.5 MHz"  
'sets the frequency offset of the interferer to 5 MHz.

*RST value	Resolution	Options	Dependencies	SCPI
1 MHz	0.01 Hz	Test cases 7.4 / 7.5 Option B20x, two options B10/B11, B13 and K42 each.	Sets commands :SOURce2:FREQ after execution of :SOURce:BB:W3GP:TS25141:TCAS:EXEC	Device-specific



**[SOURce:]BB:W3GPP:TS25141:IFSignal:MODulated:FOFFset** -40.0 MHz ... 40.0 MHz

This command sets frequency offset of the modulated interfering signal versus the wanted signal RF frequency. In mode **"According to Standard"** (:SOURce:BB:W3GPP:TS25141:EMODE STANdard) the frequency offset value is fixed to a value determined by the selected **Interferer Bandwidth** (:SOURce:BB:W3GPP:TS25141:IFS:BWIDth).

**Example:** "BB:W3GP:TS25141:TCAS TC76"

'selects test case 7.6.

"BB:W3GP:TS25141:EMOD STAN"

'selects mode **"According to Standard"**. Only settings in compliance with the standard can be made.

"BB:W3GP:TS25141:IFS:BWID WIDE"

'selects interferer scenario wideband.

"BB:W3GP:TS25141:IFS:MOD:FOFF?"

'queries the frequency offset of the modulated interferer.

Response: "20000000"

'the frequency offset is 20 MHz.

*RST value	Resolution	Options	Dependencies	SCPI
20 MHz	0.01 Hz	Test Case 7.6 Options B20x and K62, second option B10/B11 and B13 each, two options K42.	Sets commands :SOURce2:FREQ and :SOURce2:BB:FOFF after execution of :SOURce:BB:W3GP:TS25141: TCAS:EXEC	Device- specific

**[SOURce:]BB:W3GPP:TS25141:IFSignal:MODulated:POWER** -145.0 dBm ... 20.0 dBm

This command sets the RF level of the modulated interfering signal. In mode **"According to Standard"** (:SOURce:BB:W3GPP:TS25141:EMODE STANdard) the RF level value is fixed to a value determined by the selected **Interferer Bandwidth** (:SOURce:BB:W3GPP:TS25141:IFS:BWIDth).

**Example:** "BB:W3GP:TS25141:TCAS TC76"

'selects test case 7.6.

"BB:W3GP:TS25141:EMOD STAN"

'selects mode **"According to Standard"**. Only settings in compliance with the standard can be made.

"BB:W3GP:TS25141:IFS:BWID NARR"

'selects interferer scenario narrowband.

"BB:W3GP:TS25141:IFS:MOD:POW?"

'queries the RF level of the modulated interferer.

Response: "-47"

'the RF level is 47.00 dBm.

*RST value	Resolution	Options	Dependencies	SCPI
-48 dBm	0.01 dBm	Test Case 7.6 Options B20x and K62, second option B10/B11 and B13 each, two options K42.	Sets command :SOURce2:POWER after execution of :SOURce:BB:W3GP:TS25141:TC AS:EXEC	Device- specific

[SOURce:]BB:W3GPP:TS25141:IFSignal:MODulated:STATe ON | OFF

This command enable/disables the modulated interfering signal. In mode "According to Standard" (:SOURce:BB:W3GPP:TS25141:EMODe STANdard) the value is fixed to "ON".

**Example:** "BB:W3GP:TS25141:TCAS TC76"  
'selects test case 7.6.

"BB:W3GP:TS25141:EMOD STAN"  
'selects mode "According to Standard". Only settings in compliance with the standard can be made.

"BB:W3GP:TS25141:IFS:BWID NARR"  
'selects interferer scenario narrowband.

"BB:W3GP:TS25141:IFS:MOD:STAT?"  
'queries the state of the modulated interferer.

Response: "1"  
'the modulated interferer is enabled.

*RST value	Resolution	Options	Dependencies	SCPI
ON		Test Case 7.6 Options B20x and K62, second option B10/B11 and B13 each, two options K42.	Sets command :SOURce2:W3GP:STAT (Bandwidth Type Wideband) or :SOURce2:DM:STATe (Bandwidth Type Narrowband) after execution of :SOURce:BB:W3GP:TS25141:TCASe:EXEC	Device-specific

[SOURce:]BB:W3GPP:TS25141:IFSignal:MODulated:TYPE WCDMa | QPSK | GMSK

This command selects the type of modulation for the interfering uplink signal in the second path. In mode "According to Standard" (:SOURce:BB:W3GPP:TS25141:EMODe STANdard) the modulation type is fixed to 'WCDMA' for interferer scenario "wideband" and to "GMSK" for interferer scenario "narrowband" (:BB:W3GPP:TS25141:IFSignal:BWIDth WIDE|NARRow).

**Example:** "BB:W3GP:TS25141:TCAS TC76"  
'selects test case 7.6.

"BB:W3GP:TS25141:EMOD STAN"  
'selects mode "According to Standard". Only settings in compliance with the standard can be made.

"BB:W3GP:TS25141:IFS:BWID NARR"  
'selects interferer scenario narrowband.

"BB:W3GP:TS25141:IFS:MOD:TYPE?"  
'queries the type of the modulated interferer.

Response: "GMSK"  
'the modulation type is GMSK.

*RST value	Resolution	Options	Dependencies	SCPI
ON		Test case 7.6 Options B20x and K62, second option B10/B11 and B13 each, two options K42.	Sets commands of subsystem :SOURce2:W3GPP:... (WCDMa) or :SOURce2:DM:... (QPSK and GMSK) after execution of :SOURce:BB:W3GP:TS25141:TCASe:EXEC	Device-specific

[SOURce:]BB:W3GPP:TS25141:IFSignal:POWer -145.0 dBm ... 20.0 dBm

This command sets the RF level of the interfering signal. In mode "**According to Standard**" (:SOURce:BB:W3GPP:TS25141:EMODe STANdard) the RF level value is fixed to a value determined by the selected **Blocking Scenario** (:SOURce:BB:W3GPP:TS25141:WSIGnal:BTYPe).

**Example:** "BB:W3GP:TS25141:TCAS TC75"  
 'selects test case 7.6.

"BB:W3GP:TS25141:EMOD STAN"  
 'selects mode "**According to Standard**". Only settings in compliance with the standard can be made.

"BB:W3GP:TS25141:WSIG:BTYP NARR"  
 'selects blocking scenario narrowband.

"BB:W3GP:TS25141:IFS:POW?"  
 'queries the RF level of the CW interferer.

Response: "-47"  
 'the RF level is -47.00 dBm.

*RST value	Resolution	Options	Dependencies	SCPI
-15 dBm	0.01 dBm	Test case 7.5 Option B20x, second option B10/B11 and B13 each, two options K42.	Sets command :SOURce2:POWer after execution of SOUR:BB:W3GP:TS25141:TCASe:EXEC	Device-specific

[SOURce:]BB:W3GPP:TS25141:IFSignal:SETTing:TMODel:BSTation  
 TM164 | TM116 | TM132 | TM2 | TM316 | TM332 | TM4 | TM538 | TM528 | TM58

This command selects the interfering signal from a list of test models in accordance with TS 25.141. All test models refer to the predefined downlink configurations. In edit mode '**According to Standard**' (:SOURce:BB:W3GPP:TS25141:EMODe STANdard) Test Model 1, 64 DPCHs is fixed.

**Example:** "BB:W3GP:TS25141:TCAS TC66"  
 'selects test case 6.6.

"BB:W3GP:TS25141:EMOD USER"  
 'selects mode "**User Definable**".

"BB:W3GP:TS25141:IFS:SETT:TMOD:BST TM116"  
 'the interfering signal is generated according to test model Test Model 1; 16 Channels.

*RST value	Resolution	Options	Dependencies	SCPI
T164		Test case 6.6 Options B13, B9/B10/B11 and K42	Sets commands of subsystem :SOURce1:W3GPP:... after execution of SOUR:BB:W3GP:TS25141:TCASe:EXEC	Device-specific

[SOURce:]BB:W3GPP:TS25141:IFSignal:STATe ON | OFF

This command enable/disables the modulated interfering signal. In mode "**According to Standard**" (:SOURce:BB:W3GPP:TS25141:EMODe STANdard) the value is fixed to "ON".

**Example:** "BB:W3GP:TS25141:TCAS TC75"  
'selects test case 7.5.

"BB:W3GP:TS25141:EMOD STAN"  
'selects mode "**According to Standard**". Only settings in compliance with the standard can be made.

"BB:W3GP:TS25141:IFS:STAT?"  
'queries the state of the interferer.

Response: "1"  
'the interferer is enabled.

*RST value	Resolution	Options	SCPI
ON	-	Test cases 7.4 / 7.5 Options B13, B9/B10/B11, B20x , and two K42	Device-specific

[SOURce:]BB:W3GPP:TS25141:IFSignal:TYPE WCDMa | QPSK | GMSK | CW

This command selects the type of modulation for the interfering signal. In mode "**According to Standard**" (:SOURce:BB:W3GPP:TS25141:EMODe STANdard) the modulation type is fixed to '**WCDMA**' for test case 7.4 and to "**GMSK**" for test case 7.5.

**Example:** "BB:W3GP:TS25141:TCAS TC75"  
'selects test case 7.5.

"BB:W3GP:TS25141:EMOD STAN"  
'selects mode "**According to Standard**". Only settings in compliance with the standard can be made.

"BB:W3GP:TS25141:IFS:TYPE?"  
'queries the type of the interferer.

Response: "CW"  
'the modulation type is CW interferer.

*RST value	Resolution	Options	SCPI
WCDMa		Test cases 7.4 / 7.5 Options B13, B9/B10/B11, B20x , and two K42	Device-specific

**[SOURce:]BB:W3GPp:TS25141:ROUTe A | B**

The command selects the signal routing for baseband A signal which in most test cases represents the wanted signal (exception test case 6.6). The command is only available for two-path-instruments and only for test cases that do not use both paths anyway.

**Parameter: A**  
The baseband signal A is routed to RF output A.

**B**  
The baseband signal A is routed to RF output B.

**Example:** "BB:W3GP:TS25141:ROUT B"  
'the baseband signal of path A is introduced into path B.

*RST value	Resolution	Options	SCPI
A	-	All test cases minimum requirement: Option B20x, B9/B10/B11, K42 and two options B13,	Device-specific

**[SOURce:]BB:W3GPp:TS25141:RXDiversity ON | OFF**

The command sets the signal generator according to the base station diversity processing capability. The command is only available for two-path-instruments and only for test cases that do not use both paths anyway.

**Parameter: ON**  
The baseband signal A is routed to RF output A and B.

**OFF**  
The baseband signal A is routed to either to RF output A or B.

**Example:** "BB:W3GP:TS25141:RXD ON"  
'the baseband signal of path A is introduced into both paths.

*RST value	Resolution	Options	Dependencies	SCPI
OFF	-	Test cases 8.x Options B20x, B14, B15, K71, and K62, two options B10/B11 and B13 each.	Sets the power commands associated with the selected test case (e.g. :SOURce1 2:POWer) after execution of SOUR:BB:W3GP:TS25141:TCASe:EXE Cute	Device-specific

**[SOURce:]BB:W3GPp:TS25141:SCODE <numeric\_value>**

The command sets the scrambling code. The value range depends on whether the generator is used in uplink or downlink direction (test case 6.6) according to the selected test case.

**Example:** "BB:W3GP:TS25141:SCOD #H5FFF"  
'sets scrambling code #H5FFF.

*RST value	Resolution	Options	Dependencies	SCPI
#H0	-	All test cases minimum requirement: Options B13, B9/B10/B11 and K42.  For additionally required options see selected test case.	Sets command :SOURce:BB:W3GP:BST:SCODE (test case 6.6) or :SOURce:BB:W3GP:MST:SCODE after execution of SOUR:BB:W3GP:TS25141:TCASe:EXE Cute	Device-specific

[SOURce:]BB:W3GPP:TS25141:SCODE:MODE SHORT | LONG | OFF | ON

The command sets the type for the scrambling code for the uplink direction. The scrambling code generator can also be deactivated. In downlink direction (test case 6.6), the scrambling generator can be switched on and off.

**Example:** "BB:W3GP:TS25141:SCOD:MODE OFF"  
 'deactivates the scrambling code generator.

*RST value	Resolution	Options	Dependencies	SCPI
LONG   ON	-	All test cases minimum requirement: Options B13, B9/B10/B11 and K42.  For additionally required options see selected test case.	Sets command :SOUR:BB:W3GP:BST:SCOD:STAT (test case 6.6) or :SOUR:BB:W3GP:MST:SCOD:MODE after execution of SOUR:BB:W3GP:TS25141:TCAS:EXE Cute	Device-specific

[SOURce:]BB:W3GPP:TS25414:TCAS TC642 | TC66 | TC72 | TC73 | TC74 | TC75 | TC76 | TC78 | TC821 | TC86 | TC881 | TC883 | TC891 | TC893

The command selects a test case defined by the standard. The signal generator is preset according to the selected standard. The selected edit mode (SOURce:BB:W3GP:TS25141:EMODE) determines the range of parameters that can be adjusted.

**Example:** "BB:W3GP:TS25141:TCAS TC73"  
 'selects the test case 7.3, Dynamic Range.

*RST value	Resolution	Options	Dependencies	SCPI
TS642	-	Minimum requirement: Options B13, B9/B10/B11 and K42	Depending on the selected test case the parameters of the TS25141 commands are preset. For most test cases also the parameters of one or more of the subsystems SOURce:AWGN, SOURce:W3GPP, SOURce:DM and SOURce:FSIM are preset. The preset parameters are activated with command :BB:W3GP:TS25141:TCAS:EXEC	Device-specific

[SOURce:]BB:W3GPp:TS25141:TCASe:EXECute

The command activates the current settings of the test case wizard.. Signal generation is started at the first trigger received by the generator. The RF output is not activated /deactivated by this command, so care has to be taken that **RF State is On** (OUTPut:STATe ON) at the beginning of the measurement.

This command triggers an event and therefore has no \*RST value and no query form.

**Example:** "BB:W3GP:TS25141:TCAS TC73"  
 'selects the settings for test case 7.3, Dynamic Range.  
 "BB:W3GP:TS25141:BSPC MED"  
 'sets the base station power class "Medium Range BS".  
 "BB:W3GP:TS25141:SCOD #H000FFF"  
 'sets the uplink scrambling code 'H000FFF'.  
 "BB:W3GP:TS25141:WSIG:FREQ 1710MHz"  
 'sets the wanted signal frequency.  
 "BB:W3GP:TS25141:TCAS:EXEC"  
 'activates the settings for test case 7.3, Dynamic Range. For all other parameters the preset values are used.  
 "OUTP ON"  
 'activates RF output A.

*RST value	Resolution	Options	Dependencies	SCPI
TS642	-	Minimum requirement: Options B13, B9/B10/B11 and K42.  For additionally required options see selected test case.	The command activates the preset parameters of the TS25141 commands and - for most test cases - also the parameters of one or more of the subsystems SOURce:AWGN, SOURce:W3GPp, SOURce:DM and SOURce:FSIM.	Device-specific

[SOURce:]BB:W3GPp:TS25141:TRIGger AUTO | PRESet

The command selects the trigger mode. The trigger is used to synchronize the signal generator to the other equipment.

**Parameter: AUTO**  
 The trigger settings are customized for the selected test case. In most cases trigger setting **Armed Auto** with external trigger source **External Trigger 1** is used. Unless otherwise noted the trigger delay is set equal to zero.

**PRESet**  
 The current trigger settings of the signal generator are kept.

**Example:** "BB:W3GP:TS25141:TRIG AUTO"  
 'selects customization of trigger mode for the selected test case.

*RST value	Resolution	Options	Dependencies	SCPI
AUTO	-	All test cases Minimum requirement: Options B13, B9/B10/B11 and K42.  For additionally required options see selected test case.	When AUTO is selected, all commands concerning the baseband trigger settings are adjusted to the requirements of the selected test case after execution of SOUR:BB:W3GP:TS25141:TCASe:EXECute .	Device-specific

[SOURce:]BB:W3GPP:TS25141:TRIGger:OUTPut AUTO | PRESet

The command defines the signal for the selected marker output.

**Parameter:** AUTO

The marker settings are customized for the selected test case.

**PRESet**

The current marker settings of the signal generator are kept.

**Example:**

"BB:W3GP:TS25141:TRIG:OUTP PRES"

'selects that the current marker setting are kept independently of the selected test case.

*RST value	Resolution	Options	Dependencies	SCPI
AUTO	-	All test cases Minimum requirement: Options B13, B9/B10/B11 and K42.  For additionally required options see selected test case.	When AUTO is selected, all commands of the W3GPP Subsystem concerning the marker settings are adjusted to the selected test case after execution of SOUR:BB:W3GP:TS25141:TCASe:EXEC	Device-specific

[SOURce:]BB:W3GPP:TS25141:WSIGnal:BTYPe WIDE | COLocated | NARRow

The command selects the type of blocking scenario in edit mode 'According to Standard' (SOURce:BB:W3GP:TS25141:EMODE STAN). The selected blocking scenario determines the type of interfering signal and its level.

**Parameter:** WIDE

The interferer signal for wide band blocking depends on the set **Operating Band** and **RF Frequency**:

As long as the interferer **RF frequency** lies within the selected **Operating Band**, a 3GPP FDD uplink signal with a power level of -40 dB is generated for path B.

When the interferer **RF Frequency** lies outside the selected **Operating Band**, a CW carrier interfering signal with a power level of -15 dB is generated for path B.

**COLocated**

A CW carrier interfering signal with a power level of -15 dB is generated for path B.

**NARRow**

A GMSK (270.833 kHz) interfering signal with a power level of -47 dB is generated for path B.

**Example:**

"BB:W3GP:TS25141:TCAS TC75"

'selects the settings for test case 7.5, Blocking Characteristics.

"BB:W3GP:TS25141:WSIG:BTYP NARR"

'selects the GMSK (270.833 kHz) interfering signal.

*RST value	Resolution	Options	Dependencies	SCPI
WIDE		Test case 7.5 Option B20x, two options B10/B11, B13 and K42 each.	Determines the settings of subsystems :SOUR:BB:W3GP:... (WIDE), :SOUR:BB:DM:... (NARRow) or :SOUR:FREQ:... and OUTPut:... (COLocated and WIDE) after execution of :SOURce:BB:W3GP:TS25141:TCASe:EX ECute	Device-specific



[SOURce:]BB:W3GPp:TS25141:WSIGnal:DCRatio -80.0 dB .. 80.0 dB

The command sets channel power ratio of DPCCH to DPDCH.

**Example:** "BB:W3GP:TS25141:TCAS TC642"  
 'selects the settings for test case 6.4.2, Power Control Steps.  
 "BB:W3GP:TS25141:WSIG:DCR -3 dB"  
 'sets a ratio of -3 dB for DPCCH power/DPDCH power.

*RST value	Resolution	Options	Dependencies	SCPI
0 dB	0.01 dB	Test case 6.4.2 Options B13, B9/B10/B11 and K42	Sets commands :SOUR:BB:W3GP:MST1:DPCC:POW and :SOUR:BB:W3GP:MST1:DPDC:POW after execution of SOUR:BB:W3GP:TS25141:TCAS:EXEC	Device-specific

[SOURce:]BB:W3GPp:TS25141:WSIGnal:DPCCh:SFORmat 0 ... 5

The command sets the slot format for the DPCCH. The slot format defines the FBI mode and the TFCI status.

**Example:** "BB:W3GP:TS25141:TCAS TC642"  
 'selects the settings for test case 6.4.2, Power Control Steps.  
 "BB:W3GP:TS25141:WSIG:DPCC:SFOR 3"  
 'selects slot format 3 for the DPCCH.

*RST value	Resolution	Options	Dependencies	SCPI
0		Test case 6.4.2 Options B13, B9/B10/B11 and K42	Sets command :SOUR:BB:W3GP:MST1:DPCC:SFOR after execution of SOUR:BB:W3GP:TS25141:TCAS:EXEC	Device-specific

[SOURce:]BB:W3GPP:TS25141:WSIGnal:DPCCh:TPC:RDATa AGGRegated | DLISt | ONE | SINGle | ZERO

The command sets the TPC repeat pattern for verification of the base stations power control steps.

**Parameter:** **AGGRegated**  
 A 000000000111111111 pattern is sent periodically for measurement of the transmitter aggregated power control step range after 10 consecutive equal commands.

**DLISt**  
 The TPC repeat pattern is taken from a data list. The data list is selected with the command SOURce:BB:W3GP:TS25141:DPDCh:TPC:RDAT:DSElect.

**ONE**  
 A all 1 pattern is sent continuously. The base station is forced to maximum power. This selection is only available in edit mode 'User Definable' (SOURce:BB:W3GP:TS25141:EMODE USER).

**PATtern**  
 Internal data is used. The bit pattern for the data is defined by SOURce:BB:W3GP:TS25141:DPDCh:TPC:RDAT:PATtern. The maximum length is 64 bits. This selection is only available in edit mode 'User Definable' (SOURce:BB:W3GP:TS25141:EMODE USER).

**SINGle**  
 A 01 pattern is sent periodically for measurement of the transmitter power control step tolerance.

**ZERO**  
 A all 0 pattern is sent continuously. The base station is forced to minimum power. This selection is only available in edit mode 'User Definable' (SOURce:BB:W3GP:TS25141:EMODE USER).

**Example:** "BB:W3GP:TS25141:TCAS TC642"  
 'selects the settings for test case 6.4.2, Power Control Steps.  
 "BB:W3GP:TS25141:WSIG:DPCC:TPC:RDAT SING"  
 'selects the 01 pattern

*RST value	Resolution	Options	Dependencies	SCPI
SINGle		Test case 6.4.2 Options B13, B9/B10/B11 and K42	Sets command :SOUR:BB:W3GP:MST1:DPCC:TPC: DATA to DLISt and activates a predefined data list for TPC pattern (command :SOUR:BB:W3GP:MST1:DPCC:TPC: DATA:DSEL)  The commands are set only after execution of :SOURce:BB:W3GP:TS25141:TCASe:EXECu te	Device-specific

**[SOURce:]BB:W3GPp:TS25141:WSIGnal:DPCCCh:TPC:RDATa:DSElect <data\_list\_name>**

The command selects the data list when the DLISt data source is selected for the TPC repeat pattern of the DPCCH.

The files are stored with the fixed file extensions \*.dm\_iqd in a directory of the user's choice. The directory applicable to the commands is defined with the command MMEMory:CDIR. To access the files in this directory, only the file name has to be given, without the path and the file extension.

**Example:** "BB:W3GP:TS25141:TCAS TC642"  
 'selects the settings for test case 6.4.2, Power Control Steps.  
 "BB:W3GP:TS25141:WSIG:DPCC:TPC:RDAT DLIS"  
 'selects the data source DLISt.  
 "MMEM:CDIR 'D:\Lists\Dm\IQData'"  
 'selects the directory for the data lists.  
 "BB:W3GP:TS25141:WSIG:DPCC:TPC:RDAT:DSEL 'dpcch\_tpc\_1'"  
 'selects the data list 'dpcch\_tpc1'.

*RST value	Resolution	Options	Dependencies	SCPI
-		Test case 6.4.2 Options B13, B9/B10/B11 and K42	Determines contents of the predefined data list used with command : SOUR:BB:W3GP:MST1:DPCC:TPC: DTA:DSEL after execution of SOUR:BB:W3GP:TS25141:TCAS:EXEC	Device-specific

**[SOURce:]BB:W3GPp:TS25141:WSIGnal:DPCCCh:TPC:RDATa:PATTern #B0,1 ... #B11..1,64**

The command determines the bit pattern for the PATTern data source selection. The maximum length of the bit pattern is 64 bits. This command is only available in edit mode 'User Definable' (SOURce:BB:W3GP:TS25141:EMODE USER).

**Example:** "BB:W3GP:TS25141:TCAS TC642"  
 'selects the settings for test case 6.4.2, Power Control Steps.  
 "BB:W3GP:TS25141:WSIG:DPCC:TPC:RDAT PATT"  
 'selects the data source pattern.  
 "BB:W3GP:TS25141:WSIG:DPCC:TPC:RDAT:PATT #HF0C20,19"  
 'defines the TPC pattern.

*RST value	Resolution	Options	Dependencies	SCPI
#H0, 1		Test case 6.4.2 Options B13, B9/B10/B11 and K42	Determines the contents of the predefined data list used with command : SOUR:BB:W3GP:MST1:DPCC:TPC: DTA:DSEL after execution of SOUR:BB:W3GP:TS25141:TCAS:EXEC	Device-specific

[SOURce:]BB:W3GPP:TS25141:WSIGnal:DPCCh:TPC:SDATa DLISt | PMAxlessnsteps

The command sets the TPC pattern for initialization of the base stations power level in edit mode 'User Definable' (SOURce:BB:W3GP:TS25141:EMODE USER). In edit mode 'According to Standard' (SOURce:BB:W3GP:TS25141:EMODE STAN) the pattern is fixed to 'Maximum Power Less n Steps' (PMAxlessnsteps). The TPC start pattern is sent before the TPC repeat pattern to set the base station to a defined initial state for the measurement.

**Parameter:** PMAxlessnsteps

A sequence of power up steps (TPC bits "1") is followed by a number of power down steps (TPC bits "0"). The TPC bits "1" ('power up' commands) force the base station to maximum transmit power. By the n 'power down' commands the base station is set to a defined number of n power steps (e.g. 1 dB or 0.5 dB) below its maximum transmit power at the beginning of the measurement.

**DLISt**

The TPC start pattern is taken from a data list. The data list is selected with the command SOURce:BB:W3GP:TS25141:DPDCh:TPC:SDAT:DSElect. This selection is only available in edit mode 'User Definable' (SOURce:BB:W3GP:TS25141:EMODE USER).

**Example:**

"BB:W3GP:TS25141:TCAS TC642"  
 'selects the settings for test case 6.4.2, Power Control Steps.  
 "BB:W3GP:TS25141:WSIG:DPCC:TPC:SDAT PMAx"  
 'selects the 01 pattern.

RST value	Resolution	Options	Dependencies	SCPI
PMAx		Test case 6.4.2 Options B13, B9/B10/B11 and K42	Sets command :SOUR:BB:W3GP:MST1:DPCC:TPC: DATA to DLISt and activates a predefined data list for TPC pattern (command :SOUR:BB:W3GP:MST1:DPCC:TPC: DATA:DSEL)  The commands are set only after execution of :SOURce:BB:W3GP:TS25141:TCASe:EXECu te	Device- specific

**[SOURce:]BB:W3GPp:TS25141:WSIGnal:DPCCCh:TPC:SDATa:DSElect <data\_list\_name>**

The command selects the data list when the DLIS data source is selected for the TPC start pattern of the DPCCH.

The files are stored with the fixed file extensions \*.dm\_iqd in a directory of the user's choice. The directory applicable to the commands is defined with the command MMEMoRY:CDIR. To access the files in this directory, only the file name has to be given, without the path and the file extension.

**Example:**

```
"BB:W3GP:TS25141:TCAS TC642"
  'selects the settings for test case 6.4.2, Power Control Steps.

"BB:W3GP:TS25141:WSIG:DPCC:TPC:SDAT DLIS"
  'selects the data source DLIS for TPC start pattern.

"MMEM:CDIR 'D:\Lists\Dm\IQData'"
  'selects the directory for the data lists.

"BB:W3GP:TS25141:WSIG:DPCC:TPC:SDAT:DSEL 'dpcch_tpc_s'"
  'selects the data list 'dpcch_tpc_s'.
```

*RST value	Resolution	Options	Dependencies	SCPI
-		Test case 6.4.2 Options B13, B9/B10/B11 and K42	Determines contents of the predefined data list used with command : SOUR:BB:W3GP:MST1:DPCC:TPC: DTA:DSEL after execution of SOUR:BB:W3GP:TS25141:TCAS:EXEC	Device-specific

**[SOURce:]BB:W3GPp:TS25141:WSIGnal:DPCCCh:TPC:SDATa:PDSTep 1 ... 1000**

The command sets the number of power down bits in the TPC start pattern. The total TPC start pattern length is the number of 'power up' ('1') bits plus the number of n 'power down' ('0') bits. This parameter is only available for TPC Start Pattern = **Max. Pow. Less N Steps**

(:BB:W3GP:TS25141:WSIG:DPCC:TPC:SDAT PMAxlessnsteps).

**Example:**

```
"BB:W3GP:TS25141:TCAS TC642"
  'selects the settings for test case 6.4.2, Power Control Steps.

"BB:W3GP:TS25141:WSIG:DPCC:TPC:SDAT PMAx"
  'selects the pattern Max. Pow. Less N Steps.

"BB:W3GP:TS25141:WSIG:DPCC:TPC:SDAT:PUST 100"
  'defines 100 power up steps. Presumably the base station is set to
  maximum transmit power.

"BB:W3GP:TS25141:WSIG:DPCC:TPC:SDAT:PDST 10"
  'defines 10 power down steps. The base station is set to two power steps
  below its maximum transmit power.
```

*RST value	Resolution	Options	Dependencies	SCPI
1		Test case 6.4.2 Options B13, B9/B10/B11 and K42	Determines contents of the predefined data list used with command : SOUR:BB:W3GP:MST1:DPCC:TPC: DTA:DSEL after execution of SOUR:BB:W3GP:TS25141:TCAS:EXEC	Device-specific

[SOURce:]BB:W3Gpp:TS25141:WSIGnal:DPCC:TPC:SDATa:PUSTep 1 ... 1000

The command sets the number of power up bits in the TPC start pattern. The total TPC start pattern length is the number of 'power up' ('1') bits plus the number of n 'power down' ('0') bits. This parameter is only available for TPC Start Pattern = **Max. Pow. Less N Steps**

(:BB:W3GP:TS25141:WSIG:DPCC:TPC:SDAT PMAXlessnsteps).

- Example:**
- "BB:W3GP:TS25141:TCAS TC642"  
'selects the settings for test case 6.4.2, Power Control Steps.
  - "BB:W3GP:TS25141:WSIG:DPCC:TPC:SDAT PMAX"  
'selects the pattern **Max. Pow. Less N Steps**
  - "BB:W3GP:TS25141:WSIG:DPCC:TPC:SDAT:PUST 100"  
'defines 100 power up bits. The base station is (presumably) set to maximum transmit power.
  - "BB:W3GP:TS25141:WSIG:DPCC:TPC:SDAT:PDST 10"  
'defines 10 power down bits. The base station is set to two power steps below its maximum transmit power. The TPC start patter is 110 bits long.

*RST value	Resolution	Options	Dependencies	SCPI
1		Test case 6.4.2 Options B13, B9/B10/B11 and K42	Determines contents of the predefined data list used with command : SOUR:BB:W3GP:MST1:DPCC:TPC: DTA:DSEL after execution of SOUR:BB:W3GP:TS25141:TCAS:EXEC	Device-specific

[SOURce:]BB:W3Gpp:TS25141:WSIGnal:DPDC:CCODing:TYPE M12K2 | M64K | M144K | M384K | AMR

The command selects the channel coding scheme in accordance with the 3GPP specification. The channel coding scheme selected predetermines the overall symbol rate. In mode '**According to Standard**' (SOURce:BB:W3GP:TS25141:EMODE STAN), RMC 12.2 kbps (M12K2) is selected.

- Parameters:**
- M12K2**  
Measurement channel with an input data bit rate of 12.2 kbps.
  - M64K**  
Measurement channel with an input data bit rate of 64 kbps.
  - M144K**  
Measurement channel with an input data bit rate of 144 kbps.
  - M384K**  
Measurement channel with an input data bit rate of 384 kbps.
  - AMR**  
Channel coding for the AMR Coder (coding a voice channel).

- Example:**
- "BB:W3GP:TS25141:WSIG:DPDC:CCOD:TYPE M144K"  
'selects channel coding scheme RMC 144 kbps.

*RST value	Resolution	Options	Dependency	SCPI
M12K2	-	Test cases 7.3, 8.x minimum requirement: Options B13, B9/B10/B11, K42 and K62 For additionally required options see selected test case	Sets command : BB:W3GP:MST:ENH:DPDC: CCOD:TYPE and : BB:W3GP:MST:DPDC:ORAT after execution of : SOURce:BB:W3GP:TS25141:TCA Se:EXECute	Device-specific

**[SOURce:]BB:W3GPp:TS25141:WSIGnal:DPDC:h:DERRor:BIT:RATE 0.0 .. 0.1**

The command sets the bit error rate. For test case 7.8 in mode 'According to Standard' (SOURce:BB:W3GP:TS25141:EMODE STAN), only values 0.00 (no bit errors are inserted) and 0.01 (1 percent bit errors are inserted) are available. For test case 8.6 this command is only available for mode 'User Definable' (SOURce:BB:W3GP:TS25141:EMODE USER).

**Example:** "BB:W3GP:TS25141:WSIG:DPDC:DERR:BIT:RATE 1E-2"  
'sets a bit error rate of 0.01.

*RST value	Resolution	Options	Dependencies	SCPI
0.0	0.001	Test cases 7.8, 8.6 minimum requirement: Options B13, B9/B10/B11, K42 and K62  For additionally required options see selected test case	Sets command : SOUR:BB:W3GP:MST1:DPDC:ENH:DERR:BIT:RATE after execution of SOUR:BB:W3GP:TS25141:TCASe:EXECute	Device-specific

**[SOURce:]BB:W3GPp:TS25141:WSIGnal:DPDC:h:DERRor:BLOCK:RATE 0.0 .. 0.1**

The command sets the block error rate. For test case 8.6 in mode 'According to Standard' (SOURce:BB:W3GP:TS25141:EMODE STAN), only values 0.00 (no block errors are inserted) and 0.01 (1 percent block errors are inserted) are available. For test case 7.8 this command is only available for mode 'User Definable' (SOURce:BB:W3GP:TS25141:EMODE USER).

**Example:** "BB:W3GP:TS25141:WSIG:DPDC:DERR:BLOC:RATE 1E-2"  
'sets a bit error rate of 0.01.

*RST value	Resolution	Options	Dependencies	SCPI
0.0	0.001	Test cases 7.8, 8.6 minimum requirement: Options B13, B9/B10/B11 and K42  For additionally required options see selected test case	Sets command : SOUR:BB:W3GP:MST1:DPDC:ENH:DERR:BLOC:RATE after execution of SOUR:BB:W3GP:TS25141:TCASe:EXECute	Device-specific

**[SOURce:]BB:W3GPP:TS25141:WSIGnal:DPDCh:ORATe** D15K | D30K | D60K | D120k | D240k | D480k | D960k | D1920k | D2880k | D3840k | D4800k | D5760kR

The command sets the overall symbol rate. The structure of the DPDCH channel table depends on this parameter. The overall symbol rate determines which DPDCHs are active, which symbol rate they have and which channelization codes they use.

**Parameters:**       **D15K ... D5760K**  
                           15 kspS ... 6 x 960 kspS

**Example:**           "BB:W3GP:TS25141:TCAS TC642"  
                           'selects the settings for test case 6.4.2, Power Control Steps.

"BB:W3GP:TS25141:WSIG:DPDC:ORAT D15K"  
                           'sets the overall symbol rate to 15 kspS. Only DPDCH1 is active, the symbol rate is 15 kspS and the channelization code is 64.

*RST value	Resolution	Options	Dependency	SCPI
D60K	-	Test case 6.4.2 Options B13, B9/B10/B11, and K42	Sets commands :BB:W3GP:MST:DPDCh:ORATe after execution of SOUR:BB:W3GP:TS25141:TCAS:EXE Cute	Device-specific

**[SOURce:]BB:W3GPP:TS25141:WSIGnal:FREQuency**       MIN ... MAX

The command sets the RF frequency of the wanted signal.

**Example:**           "BB:W3GP:TS25141:WSIG:FREQ 2.5GHz"  
                           'sets a frequency of 2.5 GHz for the wanted signal.

*RST value	Resolution	Options	Dependencies	SCPI
1 GHz	0.01 Hz	All test cases except for 6.6 minimum requirement: Options B13, B9/B10/B11 and K42  For additionally required options see selected test case	Sets command : SOUR:FREQ after execution of SOUR:BB:W3GP:TS25141:TCA Se:EXECute	Device-specific



[SOURce:]BB:W3GPp:TS25141:WSIGnal:OBANd I | II | III | IV | V | VI

The command selects the operating band of the base station for **Wideband Blocking**. The operating band is required for calculation of power levels and interferer modulation.

- Parameters:**
- I** Operating band I: (1920 – 1980 MHz)
  - II** Operating band II: (1850 – 1910 MHz)
  - III** Operating band III: (1710 – 1785 MHz)
  - IV** Operating band IV: (1710 – 1755 MHz)
  - V** Operating band V: (824 – 849 MHz)
  - VI** Operating band VI: (830 – 840 MHz)

**Example:**

```
"BB:W3GP:TS25141:TCAS TC75"
'selects the settings for test case 7.5, Blocking Characteristics.
```

```
"BB:W3GP:TS25141:EMOD STAN"
'selects mode "According to Standard". Only settings in compliance with the
standard can be made.
```

```
"BB:W3GP:TS25141:WSIG:BTYP WIDE"
'selects blocking scenario wideband.
```

```
"BB:W3GP:TS25141:WSIG:OBAN III"
'selects operating band III.
```

*RST value	Resolution	Options	Dependencies	SCPI
1 GHz	0.01 Hz	Test case 7.5 Option B20x, two options B10/B11, B13 and K42 each.	Sets command :BB:W3GP:TS25141:IFS:TYPE	Device- specific

[SOURce:]BB:W3GPP:TS25141:WSIGnal:PCPCh:CCODing:TYPE TB168 | TB360

The command selects the Transport Block Size.

**Parameters:**     **TB168**  
                          transport block size 168 bits

**TB360**  
                          transport block size 360 bits

**Example:**         "BB:W3GP:TS25141:TCAS TC893"  
                          'selects the settings for test case 8.9.3, Demodulation of CPCH Message in Static Propagation Conditions.

                          "BB:W3GP:TS25141:WSIG:PCPC:CCOD:TYPE TB168"  
                          'selects transport block size 168 bits.

*RST value	Resolution	Options	Dependency	SCPI
TB168	-	Test case 8.9.3 Option B20xs, and two option B13, B9/B10/B11, and K42 each	Sets commands :BB:W3GP:MST:ENH:PCPC:CCOD:TYPE	Device-specific

[SOURce:]BB:W3GPP:TS25141:WSIGnal:POWer -145.0 dBm ... 20.0 dBm

The command sets the RF level of the wanted signal in mode 'User Definable' (SOURce:BB:W3GP:TS25141:EMODE USER). In edit mode 'According to Standard' (SOURce:BB:W3GP:TS25141:EMODE STAN) the RF level is determined by the selected **Power Class** (SOURce:BB:W3GP:TS25141:BSPC).

**Example:**         "BB:W3GP:TS25141:WSIG:POW?"  
                          'queries the RF level of the wanted signal.

Response:"103.1"  
                          'the RF level is -103.1 dBm

*RST value	Resolution	Options	Dependencies	SCPI
-120.3 dBm	0.01 dBm	Test cases 7.x, 8.x, 6.4.2 minimum requirement: Options B13, B9/B10/B11 and K42 For additionally required options see selected test case	Sets command :SOURce:POWer	Device-specific

[SOURce:]BB:W3GPp:TS25141:WSIGnal:PRACH:CCODing:TYPE TB168 | TB360

The command selects the Transport Block Size.

**Parameters:**     **TB168**  
                          transport block size 168 bits

**TB360**  
                          transport block size 360 bits

**Example:**         "BB:W3GP:TS25141:TCAS TC883"  
                          'selects the settings for test case 8.8.3, Demodulation of RACH Message in Static Propagation Conditions.

                          "BB:W3GP:TS25141:WSIG:PRAC:CCOD:TYPE TB168"  
                          'selects transport block size 168 bits.

*RST value	Resolution	Options	Dependency	SCPI
TB168	-	Test case 8.8.3 Option B20x, and two options B13, B9/B10/B11, and K42 each	Sets commands :BB:W3GP:MST:ENH:PRAC:CCOD:TYPE	Device-specific

[SOURce:]BB:W3GPp:TS25141:WSIGnal:STATE ON | OFF

This command enables/disables the generation of the wanted signal in mode 'User Definable'. In mode 'According to Standard' the state is fixed to 'ON'.

**Example:**         "BB:W3GP:TS25141:TCAS TC891"  
                          'selects test case 8.9.1

                          "BB:W3GP:TS25141:EMOD USER"  
                          'selects mode "User definable". Also settings that are not in compliance with the standard can be made.

                          "BB:W3GP:TS25141:WSIG:STAT OFF"  
                          'disables the generation of the wanted signal.

*RST value	Resolution	Options	Dependency	SCPI
ON	-	Test cases 6.4.2, 7.3, 8.x minimum requirement: Options B13, B9/B10/B11, K62 and K42  For additionally required options see selected test case	Sets command :BB:W3GP:STATe after execution of SOUR:BB:W3GP:TS25141:TCASe:EXE Cute	Device-specific

**[SOURce:]BB:W3Gpp:TS25141:WSIGnal:TRIGger[:EXTernal<[1]|2>]:DELay 0.0 .. 65535.0 Chips**

The command sets an additional propagation delay besides the fixed DL-UL timing offset of 1024 chip periods.

The additional propagation delay is obtained by charging the start trigger impulse with the respective delay.

**Example:** "BB:W3GP:TS25141:TCAS TC642"  
 'selects the settings for test case 6.4.2, Power Control Steps.  
 "BB:W3GP:TS25141:WSIG:TRIG:EXT:DEL 14"  
 'sets a additional propagation delay of 14 chips.

*RST value	Resolution	Options	Dependency	SCPI
0 chips	0.0 chips	Test case 6.4.2 Options B13, B9/B10/B11, and K42	Sets command :BB:W3GP:TRIGger:EXTernal:DELay after execution of SOUR:BB:W3GP:TS25141:TCASe:EXEC	Device-specific

## SOURce:CORRection Subsystem

The output level is corrected in the CORRection subsystem. Correction is performed by user-defined table values being added to the output level for the respective RF frequency. In the R&S Vector Signal Generator, this subsystem is used to select, transfer and activate user correction tables.

Each list is stored as a file. The name of the user correction file can be freely selected. The file extension \*.uco is assigned automatically and cannot be changed.

The files can be stored in a freely selectable directory and opened from there. The default directory is set using command `MMEMemory:CDIRectory`. In the case of files which are stored in the default directory, only the file name has to be specified in commands. Otherwise, the complete absolute path has to be specified with every command. The extension can be omitted in any case.

### Note

*In the following command examples, the files are stored in the default directory.*

In the case of two-path instruments with two RF paths (option R&S SMATE-B20x), level correction is performed separately for the two RF outputs. The commands which affect selection and activation of the tables are therefore path-specific. The suffix under SOURce distinguishes the outputs:

SOURce[1] = RF output A

SOURce2 = RF output B

The keyword SOURce is optional with commands for RF output A and can be omitted. For RF output B, the command must contain the keyword together with the suffix 2.

The same tables are, however, accessed for both paths. File operations such as creating, deleting and querying files are therefore path-independent. In this case, the suffix under SOURce must be omitted. An error message is displayed if the suffix is specified.

Command	Parameters	Default unit	Remark
[SOURce:]CORRection:CSET:CATalog?	-		Query only
[SOURce:]CORRection:CSET:DATA:FREQuency	300 kHz...RF <sub>max</sub> {,300 kHz...RF <sub>max</sub> }	HZ	
[SOURce:]CORRection:CSET:DATA:FREQuency:POINts?			Query only
[SOURce:]CORRection:CSET:DATA:POWer	-40 dB...6dB {,-40 dB...6 dB}	dB	
[SOURce:]CORRection:CSET:DATA:POWer:POINts?			Query only
[[:SOURce<[1]]2>:]CORRection:CSET:DATA[:SENSor<[1]]2[:3>][:POWer]:SONCe			No query
[SOURce:]CORRection:CSET:DELete	<table name>		No query
[SOURce<[1]]2>:]CORRection:DEXChange:AFILe:CATalog?			Query only
[SOURce<[1]]2>:]CORRection:DEXChange:AFILe:EXTensi on	TXT   CSV		
[SOURce<[1]]2>:]CORRection:DEXChange:AFILe:SELect	<ASCII file name>		
[SOURce<[1]]2>:]CORRection:DEXChange:AFILe:SEParat or:COLumn	TABulator   SEMicolon   COMMa   SPACe		
[SOURce<[1]]2>:]CORRection:DEXChange:AFILe:SEParat or:DECimal	DOT   COMMa		
[SOURce<[1]]2>:]CORRection:DEXChange:EXECute			No query
[SOURce<[1]]2>:]CORRection:DEXChange:MODE	IMPort   EXPort		
[SOURce<[1]]2>:]CORRection:DEXChange:SELect	<list mode file>		
[SOURce<[1]]2>:]CORRection:CSET[:SELect]	<table name>		

[SOURce<[1]]2>:]CORRection[:STATe]	ON   OFF		
[SOURce<[1]]2>:]CORRection:VALue		dB	Query only

**[SOURce:]CORRection:CSET:CATalog?**

The command requests a list of user correction tables. The individual lists are separated by commas.

The lists are stored with the fixed file extensions \*.uco in a directory of the user's choice. The directory applicable to the commands is defined with the command MMEMoRY:CDIR. A path can also be specified in command :SOUR:CORR:CSET:CAT?, in which case the files in the specified directory are read.

This command is a query command and has no \*RST value. The numerical suffix at SOURce must not be used for this command.

**Example:** "MMEM:CDIR 'D:\Lists\ucor'"  
 'selects the directory for the user correction files.  
 "CORR:CSET:CAT?"  
 'queries which correction tables are available.  
 Response: "UCOR1,UCOR2,UCOR3"  
 'the correction tables UCOR1, UCOR2 and UCOR3 are available.

*RST value	Resolution	Options	SCPI
-	-	-	Device-specific

**[SOURce:]CORRection:CSET:DATA:FREQuency**

300 kHz...RF<sub>max</sub> {,300 kHz...RF<sub>max</sub>}, (RF<sub>max</sub> depending on model)

The command transfers the frequency data to the table selected with :CORRection:CSET:SElect.

\*RST does not affect data lists. The numerical suffix at SOURce must not be used for this command.

**Example:** "CORR:CSET 'D:\Lists\ucor\ucor1'"  
 'selects the table ucor1.  
 "CORR:CSET:DATA:FREQ 100MHz,102MHz,103MHz,..."  
 'enters the frequency value in the table UCOR1.

*RST value	Resolution	Options	SCPI
-	-	-	Device-specific

**[SOURce:]CORRection:CSET:DATA:FREQuency:POINts?**

The command queries the number of frequency values in the selected table.

The command is a query command and therefore has no \*RST value. The numerical suffix at SOURce must not be used for this command.

**Example:** "CORR:CSET 'D:\Lists\ucor\ucor1'"  
 'selects the table ucor1.  
 "CORR:CSET:DATA:FREQ:POIN?"  
 'queries the number of frequency values in the table ucor1.  
 Response: "440"  
 'the table ucor1 contains 440 frequency values.

*RST value	Resolution	Options	SCPI
-	-	-	Device-specific

**[SOURce:]CORRection:CSET:DATA:POWer -40dB ... 6dB {,-40dB ... 6dB}**

The command transfers the level data to the table selected with :CORRection:CSET:SElect.

\*RST does not affect data lists. The numerical suffix at SOURce must not be used for this command.

**Example:** "CORR:CSET 'D:\Lists\ucor\ucor1'"  
 'selects the table ucor1.  
 "CORR:CSET:DATA:POW 1dB, 0.8dB, 0.75dB,..."  
 'enters the level values in the table ucor1.

*RST value	Resolution	Options	SCPI
-	-	-	Device-specific

**[SOURce:]CORRection:CSET:DATA:POWer:POINts?**

The command queries the number of level values in the selected table.

The command is a query command and therefore has no \*RST value. The numerical suffix at SOURce must not be used for this command.

**Example:** "CORR:CSET 'D:\Lists\ucor\ucor1'"  
 'selects the table ucor1.  
 "CORR:CSET:DATA:POW:POIN?"  
 'queries the number of level values in the table ucor1.  
 Response: "440"  
 'the table ucor1 contains 440 level values.

*RST value	Resolution	Options	SCPI
-	-	-	Device-specific

**[SOURce<[1]2>:]CORRection:CSET:DATA[:SENSor<[1]2|3>][:POWer]:SONCe**

The command activates the filling of the user correction list with level values acquired by the selected power sensor. All level correction values for the given frequency values are entered in the selected list. The power sensor used is selected by the suffix in key word SENSE of the command header. Suffix 1 denotes the sensor connected to the SENSOR connector, suffix 2 the sensor connected first to one of the USB interfaces and suffix 3 the sensor connected second to one of the USB interfaces.

The command is an event and therefore has no \*RST value and no query.

**Example:**           "CORR:CSET:DATA:SENS:POW:SONC"  
                       'fills of the user correction list with level values acquired by the power sensor connector to the SENSOR connector.

*RST value	Resolution	Options	SCPI
-	-	-	Device-specific

**[SOURce:]CORRection:CSET:DELeTe <table name>**

The command deletes the specified table.

The lists are stored with the fixed file extensions \*.uco in a directory of the user's choice. The directory applicable to the commands is defined with the command MMEMoRY:CDIR. A path can also be specified in command :SOUR:CORR:CSET:CAT?, in which case the file in the specified directory is deleted.

The command is an event and therefore has no \*RST value. The numerical suffix under SOURce is irrelevant.

**Example:**           "MMEM:CDIR 'D:\Lists\ucor'"  
                       'selects the directory for the user correction files.  
                       "CORR:CSET:DEL 'UCOR1'"  
                       'deletes the table ucor1.

*RST value	Resolution	Options	SCPI
-	-	-	Device-specific



**[SOURce<[1]>:]CORRection:DEXChange:AFILe:CATalog?**

The command requests a list of available ASCII files for export/import of user correction data. The individual files are separated by commas.

The ASCII files are stored with the fixed file extensions \*.txt or \*.csv in a directory of the user's choice. The directory applicable to the commands is defined with the command MMEMoRY:CDIR. A path can also be specified in command SOUR:CORR:DEXC:AFIL:CAT?, in which case the files in the specified directory are read.

The command is a query command and therefore has no \*RST value.

**Example:** MMEM:CDIR 'd:\lists/ucor/import'  
 'selects the directory for the ASCII files with frequency and level value pairs.  
 CORR:DEXC:AFIL:EXT TXT  
 'selects that ASCII files with extension \*.txt are listed.  
 CORR:DEXC:AFIL:CAT?  
 'queries the available files with extension \*.txt.  
 Response: 'ucor1,ucor2'  
 'the ASCII files ucor1.txt and ucor2.txt are available.

*RST value	Resolution	Options	SCPI
-	-	SOURce2 only with option B20x	Device-specific

**[SOURce<[1]>:]CORRection:DEXChange:AFILe:EXTension TXT | CSV**

The command selects the file extension of the ASCII file to be imported or exported. Selection TXT (text file) or CSV (Excel file) is available.

**Example:** MMEM:CDIR 'd:\lists/ucor/import'  
 'selects the directory for the ASCII files with frequency and level value pairs.  
 CORR:DEXC:AFIL:EXT TXT  
 'selects that ASCII files with extension \*.txt are listed.  
 CORR:DEXC:AFIL:CAT?  
 'queries the available files with extension \*.txt.  
 Response: 'list1,list2'  
 'the ASCII files ucor1.txt and ucor2.txt are available.

*RST value	Resolution	Options	SCPI
TXT	-	SOURce2 only with option B20x	Device-specific

**[SOURce<[1]>:]CORRection:DEXChange:AFILe:SElect <ascii\_file\_name>**

The command selects the ASCII file to be imported or exported.

The ASCII files are stored with the fixed file extensions \*.txt or \*.csv in a directory of the user's choice. The directory applicable to the commands is defined with the command MMEMory:CDIR. A path can also be specified in command SOUR:CORR:DEXC:AFIL:SEL, in which case the files are stored or loaded in the specified directory.

**Example:**           CORR:DEXC:MODE IMP  
                       'selects that ASCII files with frequency and level value pairs are imported and transferred into user correction lists.  
                       CORR:DEXC:AFIL:SEL ' `d:\user\ucor/import/ucor.csv'  
                       'selects that ASCII file ucor.csv is imported.  
                       CORR:DEXC:SEL ' `d:\user\ucor/import/ucor\_imp'  
                       'selects that the ASCII file ucor.csv is imported into user correction list ucor\_imp.

*RST value	Resolution	Options	SCPI
-	-	SOURce2 only with option B20x	Device-specific

**[SOURce<[1]>:]CORRection:DEXChange:AFILe:SEParator:COLumn TABulator | SEMicolon | COMMa | SPACe**

The command selects the separator between the frequency and level column of the ASCII table.

**Example:**           CORR:DEXC:MODE EXP  
                       'selects that the user correction list is exported into an ASCII file.  
                       CORR:DEXC:AFIL:SEL ' `d:/user/ucor/import/ucor.csv'  
                       'selects ASCII file ucor.csv as destination for the user correction list data.  
                       CORR:DEXC:AFIL:SEP:COL TAB  
                       'the pairs of frequency and level values are separated by a tabulator.  
                       CORR:DEXC:AFIL:SEP:DEC DOT  
                       'selects the decimal separator dot.  
                       CORR:DEXC:SEL ' `d:/user/ucor/import/ucor\_imp'  
                       'selects that the user correction list ucor\_imp is imported into ASCII file ucor.csv .

*RST value	Resolution	Options	SCPI
SEMIColon	-	SOURce2 only with option B20x	Device-specific

**[SOURce<[1]>:]CORRection:DEXChange:AFILe:SEParator:DECimal DOT | COMMa**

The command the decimal separator used in the ASCII data between '.' (decimal point) and ',' (comma) with floating-point numerals.

**Example:**           CORR:DEXC:MODE EXP  
                       'selects that the user correction list is exported into an ASCII file.

                      CORR:DEXC:AFIL:SEL ' `d:/user/ucor/import/ucor.csv'  
                       'selects ASCII file ucor.csv as destination for the user correction list data.

                      CORR:DEXC:AFIL:SEP:COL TAB  
                       'the pairs of frequency and level values are separated by a tabulator.

                      CORR:DEXC:AFIL:SEP:DEC DOT  
                       'selects the decimal separator dot.

                      CORR:DEXC:SEL ' `d:/user/ucor/import/ucor\_imp'  
                       'selects that the user correction list ucor\_imp is imported into ASCII file ucor.csv .

*RST value	Resolution	Options	SCPI
DOT	-	SOURce2 only with option B20x	Device-specific

**[SOURce<[1]>:]CORRection:DEXChange:EXECute**

The command starts the export or import of the selected file. When import is selected, the ASCII file is imported as user correction list. When export is selected, the user correction list is exported into the selected ASCII file.

The command triggers an event and therefore has no \*RST value.

**Example:**           CORR:DEXC:MODE IMP  
                       'selects that ASCII files with frequency and level value pairs are imported and transferred into user correction lists.

                      CORR:DEXC:AFIL:SEL ' `d:/user/ucor/import/ucor.csv'  
                       'selects that ASCII file ucor.csv is imported.

                      CORR:DEXC:SEL ' `d:/user/ucor/import/ucor\_imp'  
                       'selects that the ASCII file ucor.csv is imported into user correction list ucor\_imp.

                      CORR:DEXC:EXEC  
                       'starts the import of the ASCII file data into the user correction file.

*RST value	Resolution	Options	SCPI
-	-	SOURce2 only with option B20x	Device-specific

[SOURce<[1]]2>:]CORRection:DEXChange:MODE IMPort | EXPort

The command selects if user correction lists should be imported or exported. Depending on the selection her, the file select command define either the source or the destination for user correction lists and ASCII files.

**Example:**

```

CORR:DEXC:MODE IMP
'selects that ASCII files with frequency and level value pairs are imported and
transferred into user correction lists.

CORR:DEXC:AFIL:SEL ' `d:/user/ucor/import/ucor.csv'
'selects that ASCII file ucor.csv is imported.

CORR:DEXC:SEL ' `d:/user/ucor/import/ucor_imp'
'selects that the ASCII file ucor.csv is imported into user correction list
ucor_imp.
    
```

*RST value	Resolution	Options	SCPI
-	-	SOURce2 only with option B20x	Device-specific

[SOURce<[1]]2>:]CORRection:DEXChange:SElect <list\_name>

The command selects the user correction list to be imported or exported.

The user correction files are stored with the fixed file extensions \*.uco in a directory of the user's choice. The directory applicable to the commands is defined with the command MMEMory:CDIR. A path can also be specified in command SOUR:CORR:DEXC:SEL, in which case the files are stored or loaded in the specified directory.

**Example:**

```

CORR:DEXC:MODE IMP
'selects that ASCII files with frequency and level value pairs are imported and
transferred into user correction lists.

CORR:DEXC:AFIL:SEL ' `d:/user/ucor/import/ucor.csv'
'selects that ASCII file ucor.csv is imported.

CORR:DEXC:SEL ' `d:/user/ucor/import/ucor_imp'
'selects that the ASCII file ucor.csv is imported into user correction list
ucor_imp.
    
```

*RST value	Resolution	Options	SCPI
-	-	SOURce2 only with option B20x	Device-specific

**[SOURce<[1]|2>:]CORRection:CSET[:SElect] <table name>**

The command selects the table for user correction. Level correction must also be activated with the command `SOURce<[1]|2>:CORRection:CSET:STATe ON`.

The lists are stored with the fixed file extensions `*.uco` in a directory of the user's choice. The directory applicable to the commands is defined with the command `MMEMoRY:CDIR`. A path can also be specified in command `:SOUR:CORR:CSET:SEL`, in which case the files in the specified directory are selected.

The command is an event and therefore has no `*RST` value.

**Example:**           `"CORR:CSET 'D:\Lists\ucor\ucor1'"`  
                           'selects the table `ucor1` for RF output A.  
                           `"CORR ON"`  
                           'activates level correction for RF output A. Correction is performed using the table `ucor1`.

*RST value	Resolution	Options	SCPI
-	-	SOURce2 only with option B20x	Device-specific

**[SOURce<[1]|2>:]CORRection[:STATe] ON | OFF**

The command activates/deactivates level correction. Level correction is performed using the table which has been selected with the command `CORRection:CSET:SElect`.

**Example:**           `"SOUR2:CORR:CSET 'ucor1'"`  
                           'selects the table `ucor1` for RF output B.  
                           `"SOUR2:CORR ON"`  
                           'activates user correction for RF output B.

*RST value	Resolution	Options	SCPI
OFF	-	SOURce2 only with option B20x	Device-specific

**[SOURce:]CORRection:VALue?**

The command requests the current value for user correction.

This command is a query command and has no `*RST` value.

**Example:**           `"CORR:VAL?"`  
                           'queries the value currently used for level correction.  
                           Response: `"-3"`  
                           'the correction value is - 3dB.

*RST value	Resolution	Options	SCPI
-	-	SOURce2 only with option B20x	Device-specific

# SOURce:FM Subsystem

The FM subsystem contains the commands for checking the frequency modulation. The settings for the internal modulation source (LF generator) are made in the SOURce:LFOuTput subsystem.

Frequency modulation requires option R&S SMATE-B22 (FM/PhiM Modulator and Low Phase Noise). Two-path instruments require a second RF path (R&S SMATE-B20x option) and a second option R&SSMATE-B22.

In the case of two-path instruments, the frequency modulation can be set separately and independently for the two RF outputs. The suffix under SOURce distinguishes the outputs:

SOURce[1] = RF output A

SOURce2 = RF output B

The keyword SOURce is optional with commands for RF output A and can be omitted. For RF output B, the command must contain the keyword together with the suffix 2.

Command	Parameters	Default unit	Remark
[SOURce<[1] 2>:]FM[:DEVIation]	0 Hz...10 MHz	Hz	
[SOURce<[1] 2>:]FM:EXTErnal:COUPling	AC   DC		
[SOURce<[1] 2>:]FM:MODE	NORMal   LNOise		
[SOURce<[1] 2>:]FM:SENSitivity?			Query only
[SOURce<[1] 2>:]FM:SOURce	EXT   INT   INT, EXT		
[SOURce<[1] 2>:]FM:STATe	ON   OFF		

## [SOURce<[1]|2>:]FM[:DEVIation] 0 Hz ... 10 MHz

The command sets the modulation deviation of the frequency modulation in Hz. The maximal deviation depends on the RF frequency set and the selected modulation mode (see data sheet).

**Example:** "FM 5E3"  
'sets the FM modulation deviation to 5 kHz.

*RST value	Resolution	Options	SCPI
10 kHz	See data sheet	Option B22 SOURce2 only with second option B22	Compliant

[SOURce<[1]>:]FM:EXTernal:COUPling AC | DC

The command selects the coupling mode for the external modulation input (EXT MOD) in the case of frequency modulation.

**Note:**

*Coupling for external feed via input EXT MOD can be set independently for modulations AM, FM and PhiM.*

**Parameters:**

**AC**

The DC voltage component is disconnected from the modulation signal.

**DC**

The modulation signal is not changed.

**Example:**

"FM:EXT:COUP AC"

'selects the coupling mode AC for external frequency modulation.

*RST value	Resolution	Options	SCPI
AC	-	Option B22 SOURce2 only with second option B22	Compliant

[SOURce<[1]>:]FM:MODE NORMal | LNOise

The command selects the mode for the frequency modulation.

**Parameters:**

**NORMal**

The maximum range for modulation bandwidth and FM deviation is available.

**LNOise**

Frequency modulation with phase noise and spurious characteristics close to CW mode. The range for modulation bandwidth and FM deviation is reduced (see data sheet).

**Example:**

"FM:MODE LNO"

'selects Low Noise mode for external frequency modulation.

*RST value	Resolution	Options	SCPI
NORMal	-	Option B22 SOURce2 only with second option B22	Compliant

**[SOURce<[1]>:]FM:SENSitivity?**

The command queries the input sensitivity of the EXT MOD input in Hz/V. The command is only effective if the external modulation source is selected (SOUR:FM:SOUR EXT). The returned value depends on the modulation deviation setting (SOUR:FM:DEVIation). This value is assigned to the voltage value for full modulation of the input signal.

The command is a query command and therefore has no \*RST value.

**Example:** "FM:DEV 5E3"  
 'sets a modulation deviation of 5 kHz.  
 "FM:SENS?"  
 'queries the input sensitivity at the EXT MOD input.  
 Response: "5E3"  
 'since the voltage value for full modulation is 1V, the resulting sensitivity is precisely 5000Hz/V.

*RST value	Resolution	Options	SCPI
-	-	Option B22 SOURce2 only with second option B22	Compliant

**[SOURce<[1]>:]FM:SOURce EXT | INT | INT,EXT**

The command selects the modulation source for frequency modulation. INT is the LF generator. The frequency of the internal modulation signal can be set in the SOURce:LFOuTput subsystem. The external signal is input at the EXT MOD connector. Internal and external modulation source can be selected at the same time.

**Example:** "FM:SOUR INT"  
 'selects the internal modulation source.

*RST value	Resolution	Options	SCPI
INTernal	-	Option B22 SOURce2 only with second option B22	Compliant

**[SOURce<[1]>:]FM:STATe ON | OFF**

The command activates/deactivates frequency modulation.

Activation of frequency modulation deactivates phase modulation.

**Example:** "FM:STAT ON"  
 'activates FM modulation.

*RST value	Resolution	Options	Correlation	SCPI
OFF	-	Option B22 SOURce2 only with second option B22	FM ON deactivates phase modulation.	Compliant



## SOURce:FREQuency Subsystem

This subsystem contains the commands used to define the frequency settings for the RF sources and sweeps.

In the case of two-path instruments with two RF paths (option R&S SMATE-B20x), the numerical suffix under SOURce distinguishes between RF output A and RF output B:

SOURce[1] = RF output A

SOURce2 = RF output B

The keyword SOURce is optional with commands for RF output A and can be omitted. For RF output B, the command must contain the keyword together with the suffix 2.

Command	Parameters	Default unit	Remark
[SOURce<[1] 2>:]FREQuency:CENTer	300 kHz...RF <sub>max</sub>	Hz	RF <sub>max</sub> depending on model
[SOURce<[1] 2>:]FREQuency[:CW]:FIXed]	300 kHz...RF <sub>max</sub>	Hz	RF <sub>max</sub> depending on model
[SOURce:]FREQuency[:CW]:FIXed]:RCL	INCLude   EXCLude		
[SOURce<[1] 2>:]FREQuency:MANual	300 kHz...RF <sub>max</sub>	Hz	RF <sub>max</sub> depending on model
[SOURce<[1] 2>:]FREQuency:MODE	CW FIXed   SWEEp   LIST		
[SOURce<[1] 2>:]FREQuency:OFFSet	50 ...+50 GHz	Hz	
[SOURce<[1] 2>:]FREQuency:SPAN	0...RF <sub>max</sub>	Hz	RF <sub>max</sub> depending on model
[SOURce<[1] 2>:]FREQuency:START	300 kHz...RF <sub>max</sub>	Hz	RF <sub>max</sub> depending on model
[SOURce<[1] 2>:]FREQuency:STOP	300 kHz...RF <sub>max</sub>	Hz	RF <sub>max</sub> depending on model
[SOURce<[1] 2>:]FREQuency:STEP[:INCRement]	0...RF <sub>max</sub> - 100 kHz	Hz	
[SOURce<[1] 2>:]FREQuency:STEP:MODE	USER   DECimal		

**[SOURce<[1]|2>:FREQUENCY:CENTer 300 kHz...RF<sub>max</sub> (RF<sub>max</sub> depending on model)**

The command sets the center frequency of the sweep. This setting in combination with the span setting ([SOURce:]FREQUENCY:SPAN) defines the sweep range.

This command is linked to the commands [SOURce:]FREQUENCY:START and [SOURce:]FREQUENCY:STOP, i.e. changing these values causes the CENTer value to change, and vice versa:

$$CENTer = (START + STOP)/2.$$

As with the **Frequency** value entered in the header, the OFFSet value is also taken into consideration with this command. The specified value range is therefore only effective if OFFSet is set to 0. The value range for other OFFSet values can be calculated using the following formula.

$$300 \text{ kHz} + OFFSet \dots RF_{max} + OFFSet$$

**Example:** "FREQ:CENT 400 MHz"  
 'sets the center frequency for the frequency sweep to 400 MHz for Path A.  
 "FREQ:SPAN 200 MHz"  
 'sets a span of 200 MHz. This sets the sweep range for Path A to 300 MHz to 500 MHz.

*RST value	Resolution	Options	Correlation	SCPI
300 MHz	0.01 Hz	SOURce2 only with option B20x	CENTer = (START + STOP)/2	Compliant

**[SOURce<[1]|2>:FREQUENCY[:CW]:FIXed] 300 kHz ... RF<sub>max</sub>**

The command sets the frequency of the RF output signal for CW mode (SOURce:FREQUENCY:MODE CW). In Sweep mode (SOURce:FREQUENCY:MODE SWEep), this value is linked to the current sweep frequency.

In addition to a numerical value, it is also possible to specify UP and DOWN. The frequency is then increased or decreased by the value which is set under [SOURce<[1]|2>:FREQUENCY:STEP.

As with the **FREQ** value entered in the display, the OFFSet value is also taken into consideration with this command. The specified value range is therefore only effective if OFFSet is set to 0. The value range for other OFFSet values can be calculated using the following formula:

$$300 \text{ kHz} + OFFSet \dots RF_{max} + OFFSet$$

**Example:** "FREQ 500kHz"  
 'sets the frequency of RF output signal A to 500 kHz.

*RST value	Resolution	Options	Correlation	SCPI
1 GHz	0.01 Hz	SOURce2 only with option B20x	:FREQ for FREQ:MODE SWE linked to sweep frequency.	Compliant

**[SOURce:]FREQuency[:CW]:FIXed]:RCL INCLude | EXCLude**

The command determines whether the current frequency setting is retained or whether the stored frequency setting is adopted when an instrument configuration is loaded.

\*RST does not affect this setting. The setting is valid for both paths. If a suffix is specified, it is ignored.

**Parameters: INCLude**

The stored frequency is also loaded when a stored instrument configuration is loaded.

**EXCLude**

The RF frequency is not loaded when a stored instrument configuration is loaded. The current frequency is retained.

**Example:**

"FREQ:RCL INCL"

'the stored frequency is set if the Recall command is called.

*RST value	Resolution	Options	SCPI
-	-	SOURce2 only with option B20x	Compliant

**[SOURce<[1]|2>:]FREQuency:MANual START ... STOP**

In Sweep mode (:SOUR:FREQ:MODE SWE) the command sets the frequency for the next sweep step in the **Step** sweep mode (SOUR:SWE:MODE MAN). Here only frequency values between the settings [SOUR]:FREQ:STAR and . . . :STOP are permitted. Each sweep step is triggered by a separate SOUR:FREQ:MAN command.

As with the **Frequency** value entered in the header, the OFFSet value is also taken into consideration with this command. The specified value range is therefore only effective if OFFSet is set to 0. The value range for other OFFSet values can be calculated using the following formula.

START + OFFSet ... STOP +OFFSet

**Example:**

"SWE:MODE MAN"

'sets the **Step** sweep mode.

"FREQ:MAN 500MHz"

'sets an RF frequency of 500 MHz for the next step in the **Step** sweep mode.

"FREQ:MODE SWE"

'sets the Frequency Sweep mode for Path A. An RF frequency of 500 MHz is output.

"FREQ:MAN 550MHz"

'triggers the next sweep step with an RF frequency of 550 MHz.

*RST value	Resolution	Options	SCPI
100 MHz	0.01 Hz	SOURce2 only with option B20x	Compliant

[SOURce<[1]|2>:]FREQuency:MODE -CW|FIXed | SWEep | LIST

The command sets the instrument operating mode and therefore also the commands used to set the output frequency.

**Parameters:** CW|FIXed

The instrument operates in fixed-frequency mode for the selected path. CW and FIXed are synonyms. The output frequency is set with :SOURce:FREQuency:CW|FIXed.

**SWEep**

The instrument operates in SWEep mode for the selected path. The frequency is set using the commands SOURce:FREQuency:START; STOP; CENTer; SPAN; MANual.

**LIST**

The instrument processes a list of frequency and level settings for the selected path. The List mode settings are made in the SOURce:LIST subsystem. The setting SOURce:FREQuency:MODE LIST also sets the command SOURce:POWer:MODE automatically to LIST.

**Example:**

"FREQ:MODE SWE"

'sets the SWEep mode for Path A. The settings under SOURce:FREQuency:START; STOP; CENTer; SPAN; MANual become effective.

*RST value	Resolution	Option	Correlation	SCPI
CW	-	SOURce2 only with option B20x	FREQ:MODE LIST sets POW:MODE LIST	Compliant

[SOURce<[1]|2>:]FREQuency:OFFSet -50 GHz ... + 50 GHz

The command sets the frequency offset of a downstream instrument, e.g. a mixer. If a frequency offset is entered, the frequency entered with SOURce:FREQuency:... no longer corresponds to the RF output frequency. The following correlation applies:

$$\text{SOURce:FREQuency:...} = \text{RF output frequency} + \text{SOURce:FREQuency:OFFSet.}$$

Entering an offset does not change the RF output frequency, but rather the query value of SOURce:FREQuency:.....

**Example:**

"SOUR2:FREQ:OFFS 500kHz"

'sets the frequency offset to 500 kHz for path B.

*RST value	Resolution	Options	SCPI
0 Hz	0.01 Hz	SOURce2 only with option B20x	Compliant

**[SOURce<[1]|2>:FREQuency:SPAN 0...RF<sub>max</sub> (RF<sub>max</sub> depending on model)**

This command specifies the span for the sweep. This setting in combination with the center frequency setting ([SOUR]:FREQ:CENT) defines the sweep range.

This command is linked to the commands [SOUR]:FREQ:STAR and [:SOUR]:FREQ:STOP, i.e. changing these values causes the SPAN value to change, and vice versa:

$$SPAN = (STOP - START)$$

Negative values for SPAN are permitted; START > STOP then applies.

**Example:** "FREQ:CENT 400 MHz"  
 'sets the center frequency of the frequency sweep to 400 MHz for Path A.  
 "FREQ:SPAN 200 MHz"  
 'sets a span of 200 MHz for Path A. This sets the sweep range to 300 MHz to 500 MHz.

*RST value	Resolution	Options	Correlation	SCPI
400 MHz	0.01 Hz	SOURce2 only with option B20x	SPAN = (STOP - START)	Compliant

**[SOURce<[1]|2>:FREQuency:START 300 kHz...RF<sub>max</sub> (RF<sub>max</sub> depending on model)**

This command sets the start frequency for the sweep mode. START can be greater than STOP.

This command is linked to the commands [SOUR]:FREQ:CENT and [SOUR]:FREQ:SPAN, i.e. changing these values causes the START value to change, and vice versa:

$$START = (CENTer - SPAN/2).$$

As with the **Frequency** value entered in the header, the OFFSet value is also taken into consideration with this command. The specified value range is therefore only effective if OFFSet is set to 0. The value range for other OFFset values can be calculated using the following formula:

$$300 \text{ kHz} + OFFSet \dots RF_{max} + OFFSet$$

**Example:** "FREQ:START 1 MHz"  
 'sets the start frequency for the frequency sweep to 1 MHz for Path A.  
 "FREQ:STOP 2 GHz"  
 'sets the stop frequency for the frequency sweep to 2 GHz for Path A.

*RST value	Resolution	Options	Correlation	SCPI
100 MHz	0.01 Hz	SOURce2 only with option B20x	START = (CENTer - SPAN/2)	Compliant

**[SOURce<[1]|2>:]FREQUENCY:STOP** 300 kHz...RF<sub>max</sub> (RF<sub>max</sub> depending on model)

This command sets the stop frequency for the sweep mode. STOP can be less than START.

This command is linked to the commands [:SOUR]:FREQ:CENT and [:SOUR]:FREQ:SPAN, i.e. changing these values causes the START value to change, and vice versa:

$$STOP = (CENTER + SPAN/2).$$

As with the **Frequency** value entered in the header, the OFFSet value is also taken into consideration with this command. The specified value range is therefore only effective if OFFSet is set to 0. The value range for other OFFSet values can be calculated using the following formula:

$$300 \text{ kHz} + OFFSet \dots RF_{max} + OFFSet$$

**Example:** "FREQ:STOP 2 GHz"  
 'sets the stop frequency for the frequency sweep to 2 GHz for Path A.  
 "FREQ:STAR 1 MHz"  
 'sets the start frequency for the frequency sweep to 1 MHz for Path A.

*RST value	Resolution	Options	Correlation	SCPI
500 MHz	0.01 Hz	SOURce2 only with option B20x	STOP = (CENTER + SPAN/2)	Compliant

**[SOURce<[1]|2>:]FREQUENCY:STEP[:INCRement]** 0 Hz ... RF<sub>max</sub> - 100 kHz

The command sets the step width for the frequency setting if the frequency values UP/DOWN are used and variation mode SOUR:FREQ:STEP:MODE USER is selected. The command is linked to **Variation Step** for manual control, i.e. the command also sets the step width of the rotary knob for **Variation Active on**. In the case of two-path instruments, the step width can be set separately for each path.

**Example:** "FREQ:STEP 50 kHz"  
 'sets the step width for the frequency setting to 50 kHz'.

*RST value	Resolution	Options	SCPI
1 MHz	0.01 Hz	SOURce2 only with option B20x	Device-specific

[SOURce<[1]|2>:]FREQuency:STEP:MODE USER | DECimal

This command activates (USER) or deactivates (DECimal) the user-defined step width used when varying the frequency value with the frequency values UP/DOWN. The command is linked to the command **Variation Active** for manual control, i.e. the command also activates/deactivates the user-defined step width used when varying the frequency value with the rotary knob. In the case of two-path instruments, the step width can be set separately for each path.

**Example:**

"FREQ:STEP 50 kHz"

'sets the step width for the frequency setting to 50 kHz'.

"FREQ:STEP:MODE USER"

'activates this step width for frequency variation with the rotary knob (manual control) and with frequency values UP/DOWN (remote control)'.

*RST value	Resolution	Options	SCPI
DECimal	-	SOURce2 only with option B20x	Device-specific

# SOURce:INPut Subsystem

The SOURce:INPut subsystem contains the commands for configuring the inputs for trigger, data and control signals.

A common trigger threshold and input impedance is effective for all trigger and control signal inputs (Path A and Path B). The settings influence the digital modulations, the generation of waveforms or multicarrier signals, and all digital standards. Irrespective of this, a common threshold and input impedance is effective for the serial and parallel data input (Path A only). These data sources are available for digital modulation (**Custom Digital Modulation**).

The instrument trigger setting influences all sweeps and is effective in the List mode (Instrument Trigger, Path A and Path B).

Command	Parameters	Default unit	Remark
[SOURce:]INPut:DATA:IMPedance	G50   G1K		
[SOURce:]INPut:DATA:THReshold	0 ... 2 V		
[SOURce:]INPut:MODext:IMPedance	G50   HIGH		
[SOURce:]INPut:TRIGger:BBANd:SLOPe	POSitive   NEGative		
[SOURce:]INPut:TRIGger:IMPedance	G50   G1K		
[SOURce:]INPut:TRIGger:LEVel	0 ... 2 V		
[SOURce:]INPut:TRIGger:SLOPe	POSitive   NEGative		

## [SOURce:]INPut:DATA:IMPedance G50 | G1K

The command sets the impedance of all data inputs.

The setting affects the serial data input DATA at the front of the instrument and the serial data inputs DATA at the AUX I/O interface at the rear of the instrument.

**Example:**           "INP:DATA:IMP G50"  
                          'all data inputs are set to 50 ohm to ground.

*RST value	Resolution	Options	SCPI
G1K	-	B10/B11 and B13	Device-specific

## [SOURce:]INPut:DATA:THReshold 0 ... 2 V

The command sets the high/low threshold of the data inputs in the baseband section. In the case of positive polarity, this threshold determines the point as of which a signal is high (active) or low (inactive).

The setting affects the serial data input DATA at the front of the instrument and the serial data inputs DATA at the AUX I/O interface at the rear of the instrument.

**Example:**           "INP:DATA:THR 1 V"  
                          'a high/low threshold of 1 volt is set at all data inputs of the baseband section.  
                          The signal is high (active) for a signal voltage of 1 volt and higher.

*RST value	Resolution	Options	SCPI
-	-	B10/B11 and B13	Device-specific



**[SOURce:]INPut:MODext:IMPedance HIGH | G50**

The command sets the impedance of the EXT MOD input.

This setting affects all analog modulations which use the external modulation source.

**Parameters:**     **HIGH**  
                          > 100 kOhm to ground

**G50**  
                          50 Ohm to ground

**Example:**         "INP:MOD:IMP G50"  
                          'the EXT MOD input is set to 50 ohm to ground.

*RST value	Resolution	Options	SCPI
G50	-		Device-specific

**[SOURce:]INPut:TRIGger:BBANd:SLOPe POSitive | NEGative**

The command sets the active slope of an externally applied trigger signal at the **TRIGGER 1 | 2** connectors. The setting is effective for both connectors at the same time.

**Example:**         "INP:TRIG:BBAN:SLOP NEG"  
                          'the active slope of the external trigger signal at the TRIGGER 1 and 2 connector is the falling slope.

*RST value	Resolution	Options	SCPI
POSitive	-	B10/B11 and B13	Device-specific

**[SOURce:]INPut:TRIGger:IMPedance G1K | G50**

The command sets the impedance of the trigger and control signal inputs.

The setting affects the TRIGGER 1 and 2, and CLOCK inputs (BNC connectors at the front of the instrument), and the CW, BURST, and LEV\_ATT inputs (AUX I/O interface at the rear of the instrument).

**Parameters:**     **G1K**  
                          1 kOhm to ground

**G50**  
                          50 Ohm to ground

**Example:**         "INP:TRIG:IMP G50"  
                          'all trigger and control signal inputs are set to 50 ohm to ground. This setting is recommended in the case of high clock rates.

*RST value	Resolution	Options	SCPI
G1K	-	B10/B11 and B13	Device-specific

**[SOURce:]INPut:TRIGger:LEVel 0...2 V**

The command sets the high/low threshold of the trigger and control signal inputs in the baseband section. In the case of positive polarity, this threshold determines the point as of which a signal is high (active) or low (inactive).

The setting affects the TRIGGER 1 and 2, and CLOCK inputs (BNC connectors at the front of the instrument), and the CW, BURST, and LEV\_ATT inputs (AUX I/O interface at the rear of the instrument).

**Example:** "INP:TRIG:LEV 1 V"  
 'a high/low threshold of 1 volt is set at all trigger and control signal inputs of the baseband section. In the case of positive polarity, the signal is high (active) for a signal voltage of 1 volt and higher.

*RST value	Resolution	Options	SCPI
1 V	-	B10/B11 and B13	Device-specific

**[SOURce:]INPut:TRIGger:SLOPe POSitive | NEGative**

The command sets the active slope of an externally applied trigger signal at the INST TRIG inputs (BNC connector at the rear of the instrument for Path A, pin at the AUX I/O interface for Path B). The setting is effective for both inputs at the same time.

**Example:** "INP:TRIG:SLOP NEG"  
 'the active slope of the external trigger signal at the INST TRIG inputs (BNC connector and AUX I/O interface) is the falling slope.

*RST value	Resolution	Options	SCPI
POSitive	-		Device-specific

## SOURce:IQ Subsystem - I/Q Modulation

This subsystem contains the commands for checking the I/Q modulation.

I/Q modulation can be activated for both RF outputs in the case of two-path instruments with a second RF path (option R&S SMATE-B20x), a second R&S SMATE-B13 option (Baseband Main Module), and one of the options R&S SMATE-B10/B11 (Baseband Generator), R&S SMATE-B17 (External Baseband Input) or R&S SMATE-K62 (Noise Generator).

SOURce[1] = Path A

SOURce2 = Path B

Command	Parameters	Default unit	Remark
[SOURce<[1] 2>:]IQ:CREStfactor	0...30 dB	dB	
[SOURce<[1] 2>:]IQ:GAIN	DBM3   DB0   DB3   DB6		
[SOURce<[1] 2>:]IQ:IMPAirment:IQRatio[:MAGNitude]	-12.0...12.0 PCT	PCT	
[SOURce<[1] 2>:]IQ:IMPAirment:LEAKage:I	0 ... 50.0 PCT	PCT	
[SOURce<[1] 2>:]IQ:IMPAirment:LEAKage:Q	0 ... 50.0 PCT	PCT	
[SOURce<[1] 2>:]IQ:IMPAirment:QUADrature[:ANGLE]	-10.0...10.0 DEG	DEG	
[SOURce<[1] 2>:]IQ:IMPAirment[:STATe]	ON   OFF		
[SOURce<[1] 2>:]IQ:SOURce	ANALog   BASeband		
[SOURce<[1] 2>:]IQ:STATe	ON   OFF		
[SOURce<[1] 2>:]IQ:SWAP[:STATe]	ON   OFF		
[SOURce<[1] 2>:]IQ:WBState	ON   OFF		

### [SOURce<[1]|2>:]IQ:CREStfactor 0...30 dB

This command specifies the crest factor of the external analog signal.

**Example:** "IQ:CRESt 10"  
'specifies a crest factor of 10 dB for the external analog signal.

*RST value	Resolution	Options	SCPI
0 dB	0.01 dB	SOURce2 only with option B20x, second B13 option and at least one of options B10/B11, B17 or K62	Device-specific

[SOURce<[1]|2>:]IQ:GAIN DBM3 | DB0 | DB3 | DB6

This command specifies the baseband gain for the external analog wideband I/Q signal. Thus, the modulation of the I/Q modulator can be optimized for any measurement requirement. The gain settings for an internal or external baseband signal are performed with command

:SOURce:BB:IQGain.

**Parameters:**     **DBM3**

Activates -3 dB gain. With this setting, signal distortions are minimized.

**DB0**

Activates 0 dB gain (standard settings).

**DB3**

Activates 3 dB gain. This setting is recommended for 3GPP signals with very high adjacent channel power ratio (ACPR).

**DB6**

Activates 6 dB gain. With this setting, signal noise is minimized.

**Example:**

"IQ:SOUR ANAL"

'selects an external analog signal as the input signal for the I/Q modulator. The signal must be applied at the inputs **I** and **Q**.'

"IQ:GAIN DB0"

'sets gain 0 dB (standard).'

*RST value	Resolution	Options	SCPI
External Wideband: 3 dB	0.01 dB	SOURce2 only with option B20x, second B13 option and at least one of options B10/B11, B17 or K62	Device-specific

[SOURce<[1]|2>:]IQ:IMPairment:IQRatio[:MAGNitude] -12 ... +12 PCT

This command sets the ratio of I modulation to Q modulation (amplification "imbalance").

**Example:**

"IQ:IMP:IQR 3 PCT"

'sets the imbalance to 3 percent.'

*RST value	Resolution	Options	SCPI
0 PCT	0.05 PCT	SOURce2 only with option B20x, second B13 option and at least one of options B10/B11, B17 or K62	Device-specific

[SOURce<[1]|2>:]IQ:IMPairment:LEAKage:I 0 ... 50 PCT

This command sets the carrier offset for the I-channel of the I/Q modulation.

**Example:**

"IQ:IMP:LEAK:I 3 PCT"

'sets the leakage for the I-channel to 3 percent.'

*RST value	Resolution	Options	SCPI
0 PCT	0.05 PCT	SOURce2 only with option B20x, second B13 option and at least one of options B10/B11, B17 or K62	Device-specific

**[SOURce<[1]|2>:IQ:IMPairment:LEAKage:Q 0 ... 50 PCT**

This command sets the carrier leakage amplitude for the Q-channel of the I/Q modulation.

**Example:** "IQ:IMP:LEAK:Q 3 PCT"  
'sets the leakage for the Q-channel to 3 percent.

*RST value	Resolution	Options	SCPI
0 PCT	0.05 PCT	SOURce2 only with option B20x, second B13 option and at least one of options B10/B11, B17 or K62	Device-specific

**[SOURce<[1]|2>:IQ:IMPairment:QUADrature[:ANGLE] -10.0 ... 10.0 DEG**

This command sets the quadrature offset for the I/Q modulation.

**Example:** "IQ:IMP:QUAD:ANGL -5DEG"  
'sets the quadrature offset to -5 degrees.

*RST value	Resolution	Options	SCPI
0 DEG	0.02 DEG	SOURce2 only with option B20x, second B13 option and at least one of options B10/B11, B17 or K62	Device-specific

**[SOURce<[1]|2>:IQ:IMPairment[:STATe] ON | OFF**

The command activates (ON) and deactivates (OFF) the three impairment or correction values LEAKage, QUADrature and IQRatio for the analog signal in the I/Q modulator.

**Example:** "IQ:IMP OFF"  
'deactivates I/Q impairment.

*RST value	Resolution	Options	SCPI
OFF	-	SOURce2 only with option B20x, second B13 option and at least one of options B10/B11, B17 or K62	Device-specific

**[SOURce<[1]|2>:IQ:SOURce ANALog | BASeband**

This command selects the input signal for the I/Q modulator. This selection is only available for Path A (SOURce[1]). The input signal for the I/Q modulator of Path B is always the internal baseband signal (BASeband) I

**Example:** "IQ:SOUR ANAL"  
'selects an external analog signal as the input signal. The signal must be applied at the inputs I and Q.

*RST value	Resolution	Options	Dependencies	SCPI
BASeband		SOURce2 only with option B20x	Selecting ANALog (Wideband I/Q In) switches off: SOURce:AM:STATe OFF SOURce:BBAM:STATe OFF SOURce:BB:DM:STATe OFF SOURce:BB:<standard>:STATe OFF	Device-specific

**[SOURce<[1]|2>:IQ:STATe ON | OFF**

This command activates and deactivates I/Q modulation.

**Example:** "IQ:STAT ON"  
'activates I/Q modulation for Path A.

*RST value	Resolution	Options	SCPI
OFF	-	SOURce2 only with option B20x, second B13 option and at least one of options B10/B11, B17 or K62	Device-specific

**[SOURce<[1]|2>:IQ:SWAP[:STATe] ON | OFF**

When set to ON, this command swaps the I and Q channel.

**Example:** "IQ:SWAP ON"  
'swaps the I and Q channel.

*RST value	Resolution	Options	SCPI
OFF	-	SOURce2 only with option B20x, second B13 option and at least one of options B10/B11, B17 or K62	Device-specific

**[SOURce<[1]|2>:IQ:WBSTate ON | OFF**

This command selects optimized setting for wideband modulation signals (>5 MHz) (State ON).

**Example:** "IQ:WBST ON"  
'activates optimized setting for wideband signals.

*RST value	Resolution	Options	SCPI
OFF	-	SOURce2 only with option B20x, second B13 option and at least one of options B10/B11, B17 or K62	Device-specific

## SOURce:IQ:OUTPut Subsystem - Differential Outputs

This subsystem contains the commands for configuring the differential output.

The outputs can be assigned either to path A or to path B. Assignment is performed with command `SOURce:BB:IQOut:SOURce`.

Therefore, key word `SOURce` is without suffix in this sub system, it is optional and can be omitted.

The key word `SOURce` is optional and can be omitted.

Command	Parameters	Default unit	Remark
[SOURce:]IQ:OUTPut:BIAS:COUPling[:STATe]	ON   OFF		
[SOURce:]IQ:OUTPut:BIAS:I	-2.50 .. 2.50V	V	
[SOURce:]IQ:OUTPut:BIAS:OPTimization[:RF]:STATe	ON   OFF		
[SOURce:]IQ:OUTPut:BIAS:Q	-2.50 .. 2.50V	V	
[SOURce:]IQ:OUTPut:LEVel	<numeric value>	V	
[SOURce:]IQ:OUTPut:MODE	FIXed   VARiable		
[SOURce:]IQ:OUTPut:OFFSet:I	0 .. 600mV	V	
[SOURce:]IQ:OUTPut:OFFSet:Q	0 .. 600mV	V	
[SOURce:]IQ:OUTPut:TYPE	SINGle   DIFFerential		

### [SOURce:]IQ:OUTPut:BIAS:COUPling[:STATe] ON | OFF

This command activates/deactivates coupling of bias setting of the I-signal and Q-signal component. For activated coupling, the setting can be made for the I-signal component, it automatically applies to the Q-signal component as well.

For two-path instruments the outputs are assigned with command `SOURce:BB:IQOut:SOURce`.

**Example:** `"IQ:OUTP:BIAS:COUP ON"`  
'activates coupling of bias settings of the two components.

*RST value	Resolution	Options	Dependencies	SCPI
ON		B13 and B16	If coupling is activated, settings made for the I-signal component (SOUR:IQ:OUT:BIAS:I) automatically applies to the Q-signal (SOUR:IQ:OUT:BIAS:Q)	Device-specific

**[SOURce:]IQ:OUTPut:BIAS:I** -2.50 .. 2.50V

**[SOURce:]IQ:OUTPut:BIAS:Q** -2.50 .. 2.50V

This command sets the amplifier bias. The maximum overall voltage (SOUR:IQ:OUTPut:LEV + SOUR:IQ:OUTPut:BIAS:I|Q + SOUR:IQ:OUTPut:OFFS:I|Q) is 4 volts.

For two-path instruments the outputs are assigned with command SOURce:BB:IQOut:SOURce.

**Example:** "IQ:OUTPut:BIAS:I 0.1 V"  
'sets a bias of 100 mV for the I-signal.

*RST value	Resolution	Options	SCPI
0 V	2mV	B13 and B16	Device-specific

**[SOURce:]IQ:OUTPut:BIAS:OPTimization[:RF]:STATe** ON | OFF

This command activates/deactivates optimization of level accuracy and imbalance for RF Output. Level accuracy and imbalance can be either optimized for RF output (active) or for differential outputs (not active).

For two-path instruments the outputs are assigned with command SOURce:BB:IQOut:SOURce

**Example:** "IQ:OUTPut:BIAS:OPT:STAT ON"  
'activates optimization for RF output.

*RST value	Resolution	Options	SCPI
OFF		B13 and B16	Device-specific

**[SOURce:]IQ:OUTPut:LEVel** <numeric value>

This command sets the off-load voltage. The value range differs for the two output types. The maximum overall voltage (SOUR:IQ:OUTPut:LEV + SOUR:IQ:OUTPut:BIAS:I|Q + SOUR:IQ:OUTPut:OFFS:I|Q) is 4 volts.

**Differential output:** Value range: ± 2,0 Volt (corresponds to 0 ... 4 Volt open-circuit voltage). The maximum overall output voltage (**Level EMF + Bias + Offset**) is 4 volts.

**Single Ended:** Value range: ± 1,0 Volt (corresponds to 0 ... 2 Volt peak-peak).

For two-path instruments the outputs are assigned with command SOURce:BB:IQOut:SOURce.

**Example:** "IQ:OUTPut:LEV 2 V"  
'sets a off-load level of 2 V.

*RST value	Resolution	Options	SCPI
1 V	0.001 V	B13 and B16	Device-specific



**[SOURce:]IQ:OUTPut:MODE** FIXed | VARiable

This command selects the mode for setting the outputs.

For two-path instruments the outputs are assigned with command `SOURce:BB:IQOut:SOURce`.

**Parameter:**      **FIXed**

The settings are fixed and cannot be changed.

(`IQ:OUTPut:BIAS:I|Q = 0V`, `IQ:OUTPut:OFFSet:I|Q = 0V` and  
`IQ:OUTPut:LEVel = 2V` (TYPE DIFFerential) or `1V` (TYPE SINGle).

**VARIABLE**

The settings can be changed.

**Example:**      `"IQ:OUTP:MODE FIX"`  
                  'the predefined settings are used.

*RST value	Resolution	Options	Dependencies	SCPI
FIXed	-	B13 and B16	Selection FIXed locks all IQ:OUTPut-commands except for IQ:OUTPut:TYPE and sets them to predefined values (see above).	Device-specific

**[SOURce:]IQ:OUTPut:OFFSet:I** 0.01 .. 1.0 V**[SOURce:]IQ:OUTPut:OFFSet:Q** 0.01 .. 1.0 V

This command sets an offset between the positive and the negative output. The maximum overall voltage (`SOUR:IQ:OUTPut:LEV + SOUR:IQ:OUTP:BIAS:I|Q + SOUR:IQ:OUTP:OFFS:I|Q`) is 4 volts. The commands are only valid for output type Differential (`IQ:OUTP:TYPE DIFF`).

For two-path instruments the outputs are assigned with command `SOURce:BB:IQOut:SOURce`.

**Example:**      `"IQ:OUTP:TYPE DIFF"`  
                  'the I/Q-signal components are output differential.

`"IQ:OUTP:OFFS:I 0.05 V"`  
                  'sets an offset of 50 mV for the I-signal.

*RST value	Resolution	Options	SCPI
0 V	0.2 mV	B13 and B16	Device-specific

**[SOURce:]IQ:OUTPut:TYPE** SINGle | DIFFerential

This command selects the output type.

For two-path instruments the outputs are assigned with command `SOURce:BB:IQOut:SOURce`.

**Parameter:**      **DIFFerential**

The I/Q-signal components are output differential. A bias can be defined.

**Single Ended**

The I/Q-signal components are output single-ended.

**Example:**      `"IQ:OUTP:TYPE DIFF"`  
                  'the I/Q-signal components are output differential.

*RST value	Resolution	Options	SCPI
SINGle		B13 and B16	Device-specific

# SOURce:LFOutput Subsystem

This subsystem contains the commands for setting the LF signal source in CW and Sweep mode as well as for analog modulation. An LF generator is always available in the instrument, even in two-path instruments.

An LF sweep is set in several steps which are shown in the following example:

1. Set the sweep range.

```
LFOutput:FREQuency:START 4 kHz
LFOutput:FREQuency:STOP 10 kHz
```

2. Select linear or logarithmic sweep spacing.

```
LFOutput:SWEep[:FREQuency]:SPACing LIN
```

3. Set the step width and dwell time.

```
LFOutput:SWEep[:FREQuency]:STEP[:LINear] 100 Hz
LFOutput:SWEep[:FREQuency]:DWELl 20 ms
```

4. Determine the sweep mode.

```
LFOutput:SWEep:MODE AUTO
```

5. Determine the trigger.

```
TRIGger0:SOURce SINGLE
```

6. Activate the sweep.

```
LFOutput:FREQuency:MODE SWEep
```

7. Trigger the sweep (depending on the mode).

```
LFOutput:SWEep:EXECute
```

The keyword SOURce is optional and can be omitted. An error message is displayed if a suffix is specified.

Command	Parameters	Default unit	Remark
[SOURce:]LFOutput:FREQuency	0.1 Hz...1 MHz	Hz	
[SOURce:]LFOutput:FREQuency:MANual	0.1 Hz...1 MHz	Hz	
[SOURce:]LFOutput:FREQuency:MODE	CW FIXed   SWEep		
[SOURce:]LFOutput:FREQuency:START	0.1 Hz...1 MHz	Hz	
[SOURce:]LFOutput:FREQuency:STOP	0.1 Hz...1 MHz	Hz	
[SOURce:]LFOutput[:STATe]	ON   OFF		
[SOURce:]LFOutput:SWEep[:FREQuency]:DWELl	2 ms ... 10 s	s	
[SOURce:]LFOutput:SWEep[:FREQuency]:EXECute	-		
[SOURce:]LFOutput:SWEep[:FREQuency]:MODE	AUTO   MANual   STEP		
[SOURce:]LFOutput:SWEep[:FREQuency]:POINts	<numeric_value>		
[SOURce:]LFOutput:SWEep[:FREQuency]:SPACing	LINear   LOGarithmic		
[SOURce:]LFOutput:SWEep[:FREQuency]:STEP[:LINear]	0 ... (STOP - START)	Hz	
[SOURce:]LFOutput:SWEep[:FREQuency]:STEP:LOGarithmic	0.01 ... 50 PCT	PCT	
[SOURce:]LFOutput:VOLTage	0 V ... 4 V	V	

[SOURce:]LFOutput:FREQUENCY 0.1 Hz... 1 MHz

The command sets the frequency of the LF signal for CW mode (:SOUR:MODE CW mode). The setting is valid for all analog modulations (AM/FM/PhiM/Pulse) with internal modulation source.

In Sweep mode (SOUR:LFO:FREQ:MODE SWE), the frequency is linked to the sweep frequency.

**Example:** "LFO:FREQ 5kHz"  
'sets the frequency of the LF signal to 5 kHz.

*RST value	Resolution	Options	Correlation	SCPI
1 kHz	0.1 Hz	-	LFO:FREQ for LFO:FREQ:MODE SWE linked to sweep frequency	Compliant

[SOURce:]LFOutput:FREQUENCY:MANual START ... STOP

In Sweep mode (SOUR:LFO:FREQ:MODE SWE) the command sets the frequency for the next sweep step in the **Step** sweep mode (SOUR:LFO:SWE:MODE MAN). Here only frequency values between the settings SOUR:LFO:FREQ:STAR and . . . :STOP are permitted. Each sweep step is triggered by a separate SOUR:LFO:FREQ:MAN command.

**Example:** "LFO:SWE:MODE MAN"  
'sets the **Step** sweep mode.  
"LFO:FREQ:MAN 5 kHz"  
'sets an LF frequency of 5 kHz for the next step in the **Step** sweep mode.  
"LFO:FREQ:MODE SWE"  
'sets the LF Sweep mode. An LF frequency of 5 kHz is output.  
"LFO:FREQ:MAN 5.1 kHz"  
'triggers the next sweep step with a frequency of 5.1 kHz.

*RST value	Resolution	Options	SCPI
1 kHz	0.1 Hz.	-	Compliant

[SOURce:]LFOutput:FREQUENCY:MODE CW|FIXed | SWEep

The command sets the instrument operating mode and therefore also the commands used to set the output frequency.

**Parameters:** **CW|FIXed**  
The instrument operates in fixed-frequency mode. CW and FIXed are synonyms. The output frequency is set with [SOURce:]LFOutput:FREQUENCY.

**SWEep**  
The instrument operates in SWEep mode. The frequency is set using the commands SOURce:LFOutput:FREQUENCY:START; STOP or MANual.

**Example:** "LFO:FREQ:MODE SWE"  
'sets the SWEep mode. The settings under SOURce:LFOutput:FREQUENCY:START; STOP; MANual become effective.

*RST value	Resolution	Options	SCPI
CW	-	-	Compliant

**[SOURce:]LFOutput:FREQuency:STARt 0.1 Hz... 1 MHz**

This command sets the start frequency for the LF Sweep mode.

**Example:** "RST\*" 'activates all presetsettings.  
 "LFO:SWE:MODE AUTO" 'sets the AUTO sweep mode, i.e. each trigger triggers a complete sweep.  
 "TRIG:FSW:SOUR SING" 'sets the SINGle trigger mode, i.e. the sweep is triggered by the command :LFOutput:SWEep:EXECute or \*TRG.  
 "LFO:FREQ:STAR 100 kHz" 'sets the start frequency for the LF sweep to 100 kHz.  
 "LFO:FREQ:STOP 200 kHz" 'sets the stop frequency of the LF sweep to 200 kHz.  
 "LFO:FREQ:MODE SWE" 'sets the LF sweep mode.  
 "LFO:SWE:EXEC" 'a one-off LF sweep from 100 kHz to 200 kHz is performed. The linear step width is 1 kHz with a dwell time of 15 ms (preset values).

*RST value	Resolution	Options	SCPI
1 kHz	0.1 Hz	-	Compliant

**[SOURce:]LFOutput:FREQuency:STOP 0.1 Hz... 1 MHz**

This command sets the stop frequency for the LF sweep.

**Example:** "LFO:FREQ:STOP 200 kHz" 'sets the stop frequency for the LF sweep to 200 kHz.  
 "LFO:FREQ:STAR 100 kHz" 'sets the start frequency for the LF sweep to 100 kHz.

*RST value	Resolution	Options	SCPI
50 kHz	0.1 Hz	-	Compliant

**[SOURce:]LFOutput[:STATe] ON | OFF**

The command activates/deactivates the LF output.

**Example:** "LFO ON" 'activates the LF output. The settings under LFO:FREQ and LFO:SWE become effective.

*RST value	Resolution	Options	SCPI
OFF	-	-	Device-specific

**[SOURce:]LFOutput:SWEep[:FREQUENCY]:DWELI 2 ms...10 s**

The command sets the dwell time for each frequency step of the sweep.

**Example:** "LFO:SWE:DWEL 20 ms"  
'sets a dwell time of 20 ms.'

*RST value	Resolution	Options	SCPI
10 ms	0.1 ms	-	Device-specific

**[SOURce:]LFOutput:SWEep[:FREQUENCY]:EXECute**

The command immediately starts an LF sweep. The MODE setting determines which sweep is executed, e.g. SOURce:LFOutput:SWEep:FREQUENCY:MODE STEP. The command corresponds to the manual-control command EXECUTE SINGLE SWEEP.

This command triggers an event and therefore has no \*RST value.

**Example:** "LFO:SWE:MODE STEP"  
'sets the step-by-step processing of the LF sweep.'  
"LFO:SWE:EXEC"  
'starts a step of the LF sweep.'

*RST value	Resolution	Options	SCPI
-	-	-	Device-specific

**[SOURce:]LFOutput:SWEep[:FREQUENCY]:MODE AUTO | MANual | STEP**

The command sets the cycle mode of the LF sweep.

The assignment of the IEC/IEEE-bus commands to the sweep modes is given in the description of the sweep menus.

**Parameters:** **AUTO**  
Each trigger triggers exactly one complete sweep.

**MANual**

The trigger system is not active. Each frequency step of the sweep is triggered individually, either by varying the **Current Frequency** value using the rotary knob under manual control or by means of a :LFOutput:FREQ:MAN command under remote control. With manual control, the frequency increases or decreases (depending on the direction of the rotary encoder) by the value specified under :LFOutput:FREQ:STEP:INCRement. With remote control, the frequency is set directly with the command :LFOutput:FREQ:MAN.

**STEP**

Each trigger triggers one sweep step only. The frequency increases by the value entered under [SOURce:]LFOutput:SWEep:STEP.

**Example:** "LFO:SWE:MODE AUTO"  
'selects **Mode Auto**.'

*RST value	Resolution	Options	SCPI
AUTO	-	-	Device-specific

**[SOURce:]LFOuTput:SWEep[:FREQuency]:POINts <numeric\_value>**

The command sets the number of steps in an LF sweep. The command is linked to the command :LFOuTput:SWEep[:FREQuency]:STEP as follows:

The following applies for linear sweeps and START < STOP:  $POINts = ((STOP-START) / STEP:LIN) + 1$

The following applies for logarithmic sweeps and START < STOP:

$$POINts = ((\log STOP - \log START) / \log STEP:LOG) + 1$$

If POINTs changes, the value of STEP is adjusted. The START and STOP value is retained.

Two separate POINTs values are used for linear or logarithmic sweep spacing (LFOuTput:SWEep[:FREQuency]:SPACing LIN | LOG). The command is always effective for the currently set sweep spacing.

**Example:** "LFO:FREQ:STAR"  
'sets the start frequency to 2 kHz.  
"LFO:FREQ:STOP"  
'sets the stop frequency to 20 kHz.  
"LFO:SWE:SPAC LIN"  
'sets linear sweep spacing.  
"LFO:SWE:POIN 11"  
'sets 11 sweep steps for linear sweep spacing. The sweep step width (STEP) is automatically set to 2 kHz.

*RST value	Resolution	Options	Correlation	SCPI
100	1	-	The value of :LFO:SWE:STEP is adjusted automatically.	Device-specific (adapted to instrument properties)

**[SOURce:]LFOuTput:SWEep[:FREQuency]:SPACing LINear | LOGarithmic**

The command selects linear or logarithmic sweep spacing.

**Example:** "LFO:SWE:SPAC LIN"  
'selects linear sweep spacing.

*RST value	Resolution	Options	SCPI
LINear	-	-	Device-specific

**[SOURce:]LFOOutput:SWEep[:FREQUENCY]:STEP[:LINear] 0 ... (STOP - START)**

The command sets the step width for the linear sweep.

This command is linked to the command :LFOOutput:SWEep[:FREQUENCY]:POINTs as follows:

The following applies for  $START < STOP$ :  $POINTs = ((STOP - START) / STEP:LIN) + 1$

If  $STEP:LIN$  changes, the value of  $POINTs$  is adjusted. The  $START$  and  $STOP$  value is retained.

**Example:**

```
"LFO:FREQ:STAR"
'sets the start frequency to 2 kHz.

"LFO:FREQ:STOP"
'sets the stop frequency to 20 kHz.

"LFO:SWE:SPAC LIN"
'sets linear sweep spacing.

"LFO:SWE:STEP 2 kHz"
'sets the sweep step width to 2 kHz. The number of sweep steps for linear
sweep spacing (POINTs) is automatically set to 11.
```

*RST value	Resolution	Options	Correlation	SCPI
1kHz	0.1 Hz	-	The value of :LFO:SWE:POIN is adjusted automatically.	Device-specific

**[SOURce:]LFOOutput:SWEep[:FREQUENCY]:STEP:LOGarithmic 0.01 ... 100 PCT**

The command specifies the step width factor for logarithmic sweeps. The next frequency value of a sweep is calculated (for  $START < STOP$ ) using the following formula:

New frequency = Old frequency +  $STEP:LOG \times$  Old frequency

$STEP:LOG$  therefore gives the fraction of the old frequency. The frequency is increased by this fraction for the next sweep step. Usually  $STEP:LOG$  is given in percent, whereby the suffix **PCT** must always be used.

The command is linked to the command :LFOOutput:SWEep[:FREQUENCY]:POINTs as follows:

The following applies for logarithmic sweeps and  $START < STOP$ :

$$POINTs = ((\log STOP - \log START) / \log STEP:LOG) + 1$$

If  $STEP:LOG$  changes, the value of  $POINTs$  is adjusted. The  $START$  and  $STOP$  value is retained.

**Example:**

```
"LFO:FREQ:STAR"
'sets the start frequency to 1 kHz.

"LFO:FREQ:STOP"
'sets the stop frequency to 100 kHz.

"LFO:SWE:SPAC LOG"
'sets logarithmic sweep spacing.

"LFO:SWE:STEP:LOG 10PCT"
'sets the step width for logarithmic sweep spacing to 10% of the previous
frequency in each instance.
```

*RST value	Resolution	Options	Correlation	SCPI
1 PCT	0.01 PCT	-	The value of :LFO:SWE:POIN is adjusted automatically.	Device-specific

**[SOURce:]LFOOutput:VOLTage 0 V...4 V**

The command sets the output voltage of the LF output.

**Example:**           "LF0:VOLT 3 V"  
                      'sets the voltage of the LF output to 3 V.

RST value	Resolution	Options	SCPI
1 V	0.001 V	-	Device-specific

## SOURce:LIST Subsystem

This subsystem contains the commands for the List mode of the instrument.

The following settings are required to operate the instrument in List mode:

1. Create a list.

If a list which does not exist is selected with the :LIST:SEL command, an empty list with the name of the selected list is created.

```
SOURce1:LIST:SEL "New_list"
```

2. Fill the list with values.

All list components must be of the same length. This does not apply to components of length 1.

This is interpreted as if the component has the same length as the other components and as if all values are the same as the first value.

```
SOURce1:LIST:FREQ 100 MHz, 110 MHz, 120 MHz, ...
```

```
SOURce1:LIST:POW 2dBm, -1dBm, 0dBm, ...
```

3. Select a list.

If a new empty file has been created with the :LIST:SEL command, this file is selected, otherwise an existing list must be selected before the List mode is activated.

```
SOURce1:LIST:SEL "Old_list"
```

4. Set the dwell time.

The dwell time determines the duration of the individual list steps.

```
SOURce1:LIST:DWELL 3ms
```

5. Set the List mode.

The List mode determines the way in which the list is processed.

In the example the list is processed once only or repeatedly depending on the trigger setting.

```
SOURce1:LIST:MODE AUTO
```

6. Determine the trigger.

In the example each trigger causes the list to be processed once from beginning to end.

```
SOURce:LIST:TRIGger:SOURce SINGLE
```

7. Activate the List mode.

```
SOURce1:FREQuency:MODE LIST
```

8. Trigger the list (depending on the mode).

```
SOURce1:LIST:TRIGger:EXECute
```

9. Deactivate the List mode.

```
SOURce1:FREQuency:MODE CW
```



**Note:**

SCPI refers to the individual lists as segments.

In the case of two-path instruments with two RF paths (option R&S SMATE-B20x), the List mode is activated and set separately for the two RF outputs. The commands which affect selection and activated of the lists are therefore path-specific. The suffix under SOURce distinguishes the outputs:

SOURce[1] = RF output A

SOURce2 = RF output B

The keyword SOURce is optional with commands for RF output A and can be omitted. For RF output B, the command must contain the keyword together with the suffix 2.

The same lists are, however, accessed for both paths. File operations such as creating, deleting and querying lists are therefore path-independent. In this case, the suffix under SOURce must be omitted. An error message is displayed if the suffix is specified.

Command	Parameters	Default unit	Remark
[SOURce<[1] 2>:]LIST:CATalog?			Query only
[SOURce<[1] 2>:]LIST:DELeTe	<list name>		
[SOURce<[1] 2>:]LIST:DELeTe:ALL			
[SOURce<[1] 2>:]LIST:DEXChange:AFILe:CATalog?			Query only
[SOURce<[1] 2>:]LIST:DEXChange:AFILe:EX Tension	TXT   CSV		
[SOURce<[1] 2>:]LIST:DEXChange:AFILe:SE Lect	<ASCII file name>		
[SOURce<[1] 2>:]LIST:DEXChange:AFILe:SE Parator:COLumn	TABulator   SEMicolon   COMMa   SPACE		
[SOURce<[1] 2>:]LIST:DEXChange:AFILe:SE Parator:DECimal	DOT   COMMa		
[SOURce<[1] 2>:]LIST:DEXChange:EXECute			No query
[SOURce<[1] 2>:]LIST:DEXChange:MODE	IMPort   EXPort		
[SOURce<[1] 2>:]LIST:DEXChange:SELeCt	<list mode file>		
[SOURce<[1] 2>:]LIST:DWELI	1 ms ... 1 s	s	
[SOURce<[1] 2>:]LIST:FREQuency	300kHz..RF <sub>max</sub> {, 300kHz..RF <sub>max</sub> }   block data	Hz	RF <sub>max</sub> depending on model
[SOURce<[1] 2>:]LIST:FREQuency:POINts?			Query only
[SOURce<[1] 2>:]LIST:INDex:STARt	0 ... list length		
[SOURce<[1] 2>:]LIST:INDex:STOP	0 ... list length		
[SOURce<[1] 2>:]LIST:LEARn			No query
[SOURce<[1] 2>:]LIST:MODE	AUTO   STEP   HOP   HOPD		
[SOURce<[1] 2>:]LIST:POWer	-145 ... 30 dBm {, -145 ... 30 dBm}   block data	dBm	
[SOURce<[1] 2>:]LIST:POWer:AMode	NORMal   HPOWER		
[SOURce<[1] 2>:]LIST:POWer:POINts?			Query only
[SOURce<[1] 2>:]LIST:RESet			No query
[SOURce<[1] 2>:]LIST:SELeCT	<list name>		
[SOURce<[1] 2>:]LIST:TRIGger:EXECute			No query
[SOURce<[1] 2>:]LIST:TRIGger:SOURce	AUTO IMMediate   SINGle BUS   EXTernal		

**[SOURce<[1]|2>:]LIST:CATalog?**

The command requests a list of available lists. The individual lists are separated by commas.

The lists are stored with the fixed file extensions \*.lsw in a directory of the user's choice. The directory applicable to the commands is defined with the command MMEMory:CDIR. A path can also be specified in command SOUR:LIST:CAT?, in which case the files in the specified directory are read.

The command is a query command and therefore has no \*RST value.

**Example:**           "MMEM:CDIR 'D:\Lists\Listmode'"  
                       'selects the directory for the list mode files.  
                       "LIST:CAT?"  
                       'queries the available lists.  
                       Response: 'list1,list2'"  
                       'the lists list1 and list2 are available.

*RST value	Resolution	Options	SCPI
-	-	SOURce2 only with option B20x	Device-specific

**[SOURce<[1]|2>:]LIST:DELeTe '<list file name>'**

The command deletes the specified list.

The files are stored with the fixed file extensions \*.lsw in a directory of the user's choice. The directory applicable to the command is defined with the command MMEMory:CDIR. To access the files in this directory, only the file name has to be given, without the path and the file extension. A path can also be specified in command :SOUR:LIST:CAT?, in which case the file in the specified directory is deleted.

\*RST does not affect data lists.

**Example:**           "MMEM:CDIR 'D:\Lists\Listmode'"  
                       'selects the directory for the list mode files.  
                       "LIST:DEL 'LIST1'"  
                       'deletes the list list1

*RST value	Resolution	Options	SCPI
-	-	SOURce2 only with option B20x	Device-specific

**[SOURce<[1]2>:]LIST:DELeTe:ALL**

The command deletes all lists in the set directory. The List mode must be deactivated beforehand to ensure that no lists are selected when this command is called (SOUR:FREQ:MODE CW or SWE).

The files are stored with the fixed file extensions \*.**lsw** in a directory of the user's choice. The directory applicable to the command is defined with the command MMEMoRY:CDIR. A path can also be specified in command SOUR:LIST:CAT?, in which case all list mode files in the specified directory are deleted.

\*RST does not affect data lists.

**Example:**           "MMEM:CDIR 'D:\Lists\Listmode'"  
                       'selects the directory for the list mode files.  
                       "FREQ:MODE SWE"  
                       'deactivates the List mode for RF output A and activates the Sweep mode.  
                       "SOUR2:FREQ:MODE SWE"  
                       'deactivates the List mode for RF output B and activates Sweep mode.  
                       "LIST:DEL:ALL"  
                       'deletes all list mode files available in the set directory.

*RST value	Resolution	Options	SCPI
-	-	SOURce2 only with option B20x	Device-specific

**[SOURce<[1]2>:]LIST:DEXChange:AFILe:CATalog?**

The command requests a list of available ASCII files for export/import of list mode data. The individual files are separated by commas.

The ASCII files are stored with the fixed file extensions \*.**txt** or \*.**csv** in a directory of the user's choice. The directory applicable to the commands is defined with the command MMEMoRY:CDIR. A path can also be specified in command SOUR:LIST:DEXC:AFIL:CAT?, in which case the files in the specified directory are read.

The command is a query command and therefore has no \*RST value.

**Example:**           MMEM:CDIR 'd:\lists\listmode/import'  
                       'selects the directory for the ASCII files with frequency and level value pairs.  
                       LIST:DEXC:AFIL:EXT TXT  
                       'selects that ASCII files with extension \*.txt are listed.  
                       LIST:DEXC:AFIL:CAT?  
                       'queries the available files with extension \*.txt.  
                       Response: 'list1,list2'  
                       'the ASCII files list1.txt and list2.txt are available.

*RST value	Resolution	Options	SCPI
-	-	SOURce2 only with option B20x	Device-specific

**[SOURce<[1]|2>:]LIST:DEXChange:AFILe:EXTension TXT | CSV**

The command selects the file extension of the ASCII file to be imported or exported. Selection TXT (text file) or CSV (Excel file) is available.

**Example:**           MMEM:CDIR `d:\lists\listmode/import`  
                       'selects the directory for the ASCII files with frequency and level value pairs.

                      LIST:DEXC:AFIL:EXT TXT  
                       'selects that ASCII files with extension \*.txt are listed.

                      LIST:DEXC:AFIL:CAT?  
                       'queries the available files with extension \*.txt.

                      Response: 'list1,list2'  
                       'the ASCII files list1.txt and list2.txt are available.

*RST value	Resolution	Options	SCPI
TXT	-	SOURce2 only with option B20x	Device-specific

**[SOURce<[1]|2>:]LIST:DEXChange:AFILe:SELEct <ascii\_file\_name>**

The command selects the ASCII file to be imported or exported.

The ASCII files are stored with the fixed file extensions \*.txt or \*.csv in a directory of the user's choice. The directory applicable to the commands is defined with the command MMEMory:CDIR. A path can also be specified in command SOUR:LIST:DEXC:AFIL:SEL, in which case the files are stored or loaded in the specified directory.

**Example:**           LIST:DEXC:MODE IMP  
                       'selects that ASCII files with frequency and level value pairs are imported and transferred into list mode lists.

                      LIST:DEXC:AFIL:SEL ' `d:\user\listmode/import/list.csv`  
                       'selects that ASCII file list.csv is imported.

                      LIST:DEXC:SEL ' `d:\user\listmode/import/list\_imp`  
                       'selects that the ASCII file list.csv is imported into list mode list list\_imp.

*RST value	Resolution	Options	SCPI
-	-	SOURce2 only with option B20x	Device-specific

[SOURce<[1]|2>:]LIST:DEXChange:AFIL:SEParator:COLumn TABulator | SEMicolon | COMMa | SPACe

The command selects the separator between the frequency and level column of the ASCII table.

**Example:** LIST:DEXC:MODE EXP  
 'selects that the list mode list is exported into an ASCII file.  
 LIST:DEXC:AFIL:SEL ' 'd:\user\listmode/import/list.csv'  
 'selects ASCII file list.csv as destination for the list mode list data.  
 LIST:DEXC:AFIL:SEP:COL TAB  
 'the pairs of frequency and level values are separated by a tabulator.  
 LIST:DEXC:AFIL:SEP:DEC DOT  
 'selects the decimal separator dot.  
 LIST:DEXC:SEL ' 'd:\user\listmode/import/list\_imp'  
 'selects that the list mode list list\_imp is imported into ASCII file list.csv .

*RST value	Resolution	Options	SCPI
SEMICOLON	-	SOURCE2 only with option B20x	Device-specific

[SOURce<[1]|2>:]LIST:DEXChange:AFIL:SEParator:DECimal DOT | COMMa

The command the decimal separator used in the ASCII data between '.' (decimal point) and ',' (comma) with floating-point numerals.

**Example:** LIST:DEXC:MODE EXP  
 'selects that the list mode list is exported into an ASCII file.  
 LIST:DEXC:AFIL:SEL ' 'd:\user\listmode/import/list.csv'  
 'selects ASCII file list.csv as destination for the list mode list data.  
 LIST:DEXC:AFIL:SEP:COL TAB  
 'the pairs of frequency and level values are separated by a tabulator.  
 LIST:DEXC:AFIL:SEP:DEC DOT  
 'selects the decimal separator dot.  
 LIST:DEXC:SEL ' 'd:\user\listmode/import/list\_imp'  
 'selects that the list mode list list\_imp is imported into ASCII file list.csv .

*RST value	Resolution	Options	SCPI
DOT	-	SOURCE2 only with option B20x	Device-specific

**[SOURce<[1]|2>:]LIST:DEXChange:EXECute**

The command starts the export or import of the selected file. When import is selected, the ASCII file is imported as list mode list. When export is selected, the list mode list is exported into the selected ASCII file.

The command triggers an event and therefore has no \*RST value.

**Example:**

```
LIST:DEXC:MODE IMP
    'selects that ASCII files with frequency and level value pairs are imported and
    transferred into list mode lists.

LIST:DEXC:AFIL:SEL ' `d:\user/listmode/import/list.csv'
    'selects that ASCII file list.csv is imported.

LIST:DEXC:SEL ' `d:\user/listmode/import/list_imp'
    'selects that the ASCII file list.csv is imported into list mode list list_imp.

LIST:DEXC:EXEC
    'starts the import of the ASCII file data into the list mode file.
```

*RST value	Resolution	Options	SCPI
-	-	SOURce2 only with option B20x	Device-specific

**[SOURce<[1]|2>:]LIST:DEXChange:MODE IMPort | EXPort**

The command selects if list mode lists should be imported or exported. Depending on the selection her, the file select command define either the source or the destination for list mode lists and ASCII files.

**Example:**

```
LIST:DEXC:MODE IMP
    'selects that ASCII files with frequency and level value pairs are imported and
    transferred into list mode lists.

LIST:DEXC:AFIL:SEL ' `d:\user/listmode/import/list.csv'
    'selects that ASCII file list.csv is imported.

LIST:DEXC:SEL ' `d:\user/listmode/import/list_imp'
    'selects that the ASCII file list.csv is imported into list mode list list_imp.
```

*RST value	Resolution	Options	SCPI
-	-	SOURce2 only with option B20x	Device-specific

**[SOURce<[1]|2>:]LIST:DEXChange:SElect <list\_name>**

The command selects the list mode list to be imported or exported. .

The list mode files are stored with the fixed file extensions \*.**lsw** in a directory of the user's choice. The directory applicable to the commands is defined with the command `MMEMoRY:CDIR`. A path can also be specified in command `SOUR:LIST:DEXC:SEL`, in which case the files are stored or loaded in the specified directory.

**Example:**       `LIST:DEXC:MODE IMP`  
                   'selects that ASCII files with frequency and level value pairs are imported and transferred into list mode lists.

`LIST:DEXC:AFIL:SEL ' 'd:\user\listmode/import/list.csv'`  
                   'selects that ASCII file list.csv is imported.

`LIST:DEXC:SEL ' 'd:\user\listmode/import/list_imp'`  
                   'selects that the ASCII file list.csv is imported into list mode list list\_imp.

*RST value	Resolution	Options	SCPI
-	-	SOURce2 only with option B20x	Device-specific

**[SOURce<[1]|2>:]LIST:DWELI 1 ms ... 1 s**

The command sets the time for which the instrument retains a setting.

**Example:**       `"LIST:DWEL 15"`  
                   'each setting in the list is retained for 15 ms.

*RST value	Resolution	Options	SCPI
10 ms	-	SOURce2 only with option B20x	Compliant

**[SOURce<[1]|2>:]LIST:FREquency**

300 kHz...RF<sub>max</sub> {, 300 kHz...RF<sub>max</sub>} | block data (RF<sub>max</sub> depending on model)

The command fills the FREquency part of the selected list with data. The data can be given either as a list of numbers (list can be of any length and list entries must be separated by commas) or as binary block data. When block data is transferred, 8 (4) bytes are always interpreted as a floating-point number with double accuracy (see the command `FORMat:DATA`).

\*RST does not affect data lists.

**Example:**       `"LIST:SEL 'D:\Lists\Listmode\list3'"`  
                   'selects list3 for editing. List3 is created if it does not yet exist.

`"SOUR:LIST:FREQ 1.4GHz, 1.3GHz, 1.2GHz,..."`  
                   'specifies the frequency values in list3. If the list already contains data, it is overwritten.

*RST value	Resolution	Options	SCPI
-	-	SOURce2 only with option B20x	Compliant

**[SOURce<[1]|2>:]LIST:FREQUency:POINts?**

The command queries the length (in points) of the FREQUency component of the selected list.  
 The command is a query command and therefore has no \*RST value.

**Example:**       "LIST:SEL 'D:\Lists\Listmode\list3'"  
                   'selects list3 for editing. List3 is created if it does not yet exist.  
                   "LIST:FREQ:POIN?"  
                   'queries the number of frequency values in list3  
                   Response: "327"  
                   'list3 has 327 frequency entries.

*RST value	Resolution	Options	SCPI
-	-	SOURce2 only with option B20x	Compliant

**[SOURce<[1]|2>:]LIST:INDex:STARt 0 ... list length**

The command sets the start index of the index range which defines a subgroup of frequency/level value pairs in the current list. Only the values in the set index range (:LIST:INDex:STARt ... :LIST:INDex:STOP) are processed in List mode.

**Example:**       "LIST:SEL 'D:\Lists\Listmode\list3'"  
                   'selects list3 for use in List mode.  
                   "LIST:IND:STAR 25"  
                   'sets 25 as start index of the index range.  
                   "LIST:IND:STOP 49"  
                   'sets 49 as stop index of the index range.  
                   "FREQ:MODE LIST"  
                   'activates List mode. The frequency/level value pairs from index 25 to index 49  
                   in list3 are processed. All other entries of the list are ignored.

*RST value	Resolution	Options	SCPI
0	-	SOURce2 only with option B20x	Device-specific



**[SOURce<[1]|2>:]LIST:INDEX:STOP 0 ... list length**

The command sets the stop index of the index range which defines a subgroup of frequency/level value pairs in the current list. Only the values in the set index range (:LIST:INDEX:START ... :LIST:INDEX:STOP) are processed in List mode.

**Example:**           "LIST:SEL 'D:\Lists\Listmode\list3'"  
                       'selects list3 for use in List mode.  
                       "LIST:IND:STAR 25"  
                       'sets 25 as start index of the index range.  
                       "LIST:IND:STOP 49"  
                       'sets 49 as stop index of the index range.  
                       "FREQ:MODE LIST"  
                       'activates List mode. The frequency/level value pairs from index 25 to index 49 in list3 are processed. All other entries of the list are ignored.

*RST value	Resolution	Options	SCPI
0	-	SOURce2 only with option B20x	Device-specific

**[SOURce<[1]|2>:]LIST:LEARn**

The command learns the selected list, i.e. it determines the hardware setting for the entire list. The data determined in this way is stored together with the list. When the list is activated for the first time, these settings are calculated automatically.

The command triggers an event and therefore has no \*RST value.

**Example:**           :LIST:SEL 'D:\Lists\Listmode\list3'"  
                       'Selects list3. List3 is created if it does not yet exist.  
                       "LIST:LEAR"  
                       'Starts learning of the hardware setting for list3 and stores the setting.

*RST value	Resolution	Options	SCPI
-	-	SOURce2 only with option B20x	Device-specific

[SOURce<[1]]2>:LIST:MODE AUTO | STEP | HOP | DHOP

The command specifies how the list is to be processed (similar to SOURce:SWEep:MODE).

**Parameters:**     **AUTO**

Each trigger event triggers a complete list cycle. Possible trigger settings for :LIST:TRIGger:SOURce are AUTO, SINGle and EXT.

**STEP**

Each trigger event triggers only one step in the list processing cycle. Possible trigger settings for :LIST:TRIGger:SOURce are SINGle and EXT

**HOP**

Index-by-index cycle. The processed list index is determined by the external control signals provided via the serial FHOP bus on the Digital I/O interface at the rear of the instrument (see above, introduction to list mode). The external trigger signal is used (:LIST:TRIGger:SOURce EXT).

**DHOP**

Index-by-index cycle. The processed list index is determined by the external control signals provided via the serial FHOP bus on the Digital I/O interface at the rear of the instrument. Processing of the frequency and level settings associated with selected index is automatically started at the end of data transmission. The trigger source has to be set to external (:LIST:TRIGger:SOURce EXT).

**Example:**

"LIST:MODE STEP"  
'selects step-by-step processing of the list.

*RST value	Resolution	Options	SCPI
AUTO	-	SOURce2 only with option B20x	Compliant

[SOURce<[1]]2>:LIST:POWer -145 ...30 dBm {, -145 ...30 dBm} | block data

The command fills the Level part of the selected list with data. The data can be given either as a list of numbers (list can be of any length and list entries must be separated by commas) or as binary block data. When block data is transferred, 8 (4) bytes are always interpreted as a floating-point number with double accuracy (see the command FORMat:DATA).

\*RST does not affect data lists.

**Example:**

"LIST:SEL 'D:\Lists\Listmode\list3'"  
'selects list3 for editing. List3 is created if it does not yet exist.  
"LIST:POW 0dBm, 2dBm, 2dBm, 3dBm,.."'  
'specifies the level values in list3. The number of level values must correspond to the number of frequency values. The previous data is overwritten.

*RST value	Resolution	Options	SCPI
-	-	SOURce2 only with option B20x	Compliant

[SOURce<[1]>:]LIST:POWer:AMODe NORMal | HPOWer

The command selects the ranges of level settings for the list mode. The level settings are either performed in the low level or in the high level ranges.

**Parameters:**      **NORMal**  
                          **With Option High Power only:** The level settings are made in the range of the electronically switching attenuator. The high level ranges are not available.

**HPOWer**  
                          **With Option High Power only:** The level settings are made in the range of the option. Only the high level range is available.

**Example:**            "LIST:POW:AMOD HPOW"  
                          'selects the high level ranges for List Mode'.

*RST value	Resolution	Options	SCPI
NORMal	-	SOURce2 only with option B20x	Device-specific

[SOURce<[1]>:]LIST:POWer:POINts?

The command queries the length (in points) of the LEVel part of the selected list.

The command is a query command and therefore has no \*RST value.

**Example:**            "LIST:SEL 'D:\Lists\Listmode\list3'"  
                          'selects list3 for editing. List3 is created if it does not yet exist.

"LIST:POW:POIN?"  
                          'queries the number of levels in list3

Response: "327"  
                          'LIST2 has 327 level entries.

*RST value	Resolution	Options	SCPI
-	-	SOURce2 only with option B20x	Compliant

[SOURce<[1]>:]LIST:RESet

The command resets the list to the starting point.

The command triggers an event and therefore has no reset value.

**Example:**            "LIST:RES"  
                          'resets the list to the starting point.

*RST value	Resolution	Options	SCPI
-	-	SOURce2 only with option B20x	Device-specific

**[SOURce<[1]|2>:]LIST:SElect '<list name>'**

The command selects the specified list. If a new list is to be created, the name can be entered here. The list is created if it does not yet exist. The list selected here is available for the further processing steps (editing) and is used in the instrument when the List mode is activated.

The files are stored with the fixed file extensions **\*.lsw** in a directory of the user's choice. The directory applicable to the command is defined with the command `MMEMory:CDIR`. A path can also be specified in command `:SOUR:LIST:SEL` in which case the list mode file in the specified directory is selected.

\*RST does not affect data lists.

**Example:**           `"LIST:SEL 'D:\Lists\Listmode\list3'"`  
                           `'selects list3 for editing. List3 is created if it does not yet exist.`

*RST value	Resolution	Options	SCPI
-	-	SOURce2 only with option B20x	Device-specific

**[SOURce<[1]|2>:]LIST:TRIGger:EXECute**

The command immediately starts the processing of a list in list mode. It corresponds to the manual-control command **Execute Single**.

The command triggers an event and therefore has no reset value.

**Example:**           `"SOUR2:LIST:TRIG:EXEC"`  
                           `'triggers the processing of the selected list for path B.`

*RST value	Resolution	Options	SCPI
-	-	SOURce2 only with option B20x	Device-specific

**[SOURce<[1]|2>:]LIST:TRIGger:SOURce** AUTO|IMMEDIATE | SINGLE | EXTernal|BUS

The command sets the trigger source for the LIST mode.

The names of the parameters correspond to those under sweep mode. SCPI uses other names for the parameters; these names are also accepted by the instrument. The SCPI names should be used if compatibility is an important consideration. An overview of the various names is given in the following table:

R&S name	SCPI name	Command under manual control
AUTO	IMMEDIATE	MODE AUTO
SINGLE	BUS	MODE SINGLE or STEP
EXTernal	EXTernal	MODE EXT TRIG SINGLE or EXT TRIG STEP

**Parameters:**

**AUTO**

The trigger is free-running, i.e. the trigger condition is fulfilled continuously. The selected list in List mode is restarted as soon as it is finished.

**SINGLE**

The list is triggered by the IEC/IEEE-bus commands `SOURce:LIST:TRIGger:EXECute`. The list is executed once.

**EXTernal**

The list is triggered externally via the INST TRIG connector (Path A = BNC connector; Path B = Pin at AUX I/O interface). The list is executed once.

**Example:**

`"TRIG:LIST:SOUR EXT"`  
 'selects triggering by means of the external trigger. The trigger is input via the INST TRIG connector.

*RST value	Resolution	Options	SCPI
SINGLE	-	SOURce2 only with option B20x	Device-specific

# SOURce:MODulation Subsystem

This subsystem contains the command for switching on/off all modulations.

Command	Parameters	Default unit	Remark
[SOURce:]MODulation[:ALL]:STATe	ON   OFF		

## [SOURce:]MODulation[:ALL]:STATe ON | OFF

The command switches the modulations on and off. In the two-path mode, command :SOUR:MOD:ALL:STAT OFF switches all modulations off. A subsequent command :SOUR:MOD:ALL:STAT ON restores the status that was active before the last switch-off. **MOD OFF** is displayed in the info line of the header next to the **Level** field.

The keyword SOURce is optional. The setting is valid for both paths. If a suffix is specified, an error message is generated.

**Example:**           "MOD:STAT OFF"  
                              'switches off all modulations

*RST value	Resolution	Options	SCPI
IN	-	-	Device-specific

## SOURce:PATH Subsystem

This subsystem contains the command for retrieving the number of installed RF paths.

Command	Parameters	Default unit	Remark
[SOURce:]PATH:COUNT?			Query only

### [SOURce:]PATH:COUNT

The command queries the number of installed RF paths.

This command is a query and therefore has no \*RST value.

**Example:**       "PATH:COUN?"  
                  'queries the number of RF paths.

Response:"1"  
          'the instrument is equipped with one RF path.

*RST value	Resolution	Options	SCPI
-	-	Response 2 only with option B20x	Device-specific

# SOURce:PHASe Subsystem

This subsystem contains the commands for adjusting the phase of the RF output signal relative to a reference signal of the same frequency.

In the case of two-path instruments with a second RF path (option R&S SMATE-B20x), the numerical suffix under SOURce distinguishes between RF output A and RF output B:

SOURce[1]= RF output A

SOURce2 = RF output B

The keyword SOURce is optional with commands for RF output A and can be omitted. For RF output B, the command must contain the keyword together with the suffix 2.

The keyword SOURce is optional and can be omitted.

Command	Parameters	Default unit	Remark
[SOURce<[1] 2>:]PHASe	-359.9 deg ... +359.9 deg	RAD	
[SOURce<[1] 2>:]PHASe:REFeRence			No query

## [SOURce<[1]|2>:]PHASe -359.9 deg ... +359.9 deg

The command specifies the phase variation relative to the current phase. The variation can be specified in RADians.

**Example:** "PHAS 2DEG"  
 'changes the phase by 2 degrees relative to the current phase.'  
 "PHAS : REF"  
 'adopts the set phase as the current phase'.

*RST value	Resolution	Options	SCPI
0.0 deg	0.1 deg	SOURce2 only with option B20x	Compliant

## [SOURce<[1]|2>:]PHASe:REFeRence

The command adopts the phase set with SOURce:PHASe:ADJusT as the current phase.

The command triggers an event and therefore has no \*RST value and no query form.

**Example:** "PHAS 0.1RAD"  
 'changes the phase by 0.1 rad relative to the current phase.'  
 "PHAS : REF"  
 'adopts the set phase as the current phase'.

*RST value	Resolution	Options	SCPI
-	-	SOURce2 only with option B20x	Compliant



## SOURce:PM Subsystem

The PM subsystem contains the commands for checking the phase modulation. The settings for the internal modulation source (LF generator) are made in the SOURce:LFOutput subsystem.

Phase modulation requires option R&S SMATE-B22 (PM/PhiM Modulator and Low Phase Noise). Twopath instruments require a second RF path (R&S SMATE-B20x option) and a second option R&S SMATE-B22.

Command	Parameters	Default unit	Remark
[SOURce<[1]>:]PM[:DEVIation]	0 ...20 RAD	RAD	
[SOURce<[1]>:]PM:EXTernal:COUPLing	AC   DC		
[SOURce<[1]>:]PM:MODE	HBANdwidth   HDEVIation   LNOise		
[SOURce<[1]>:]PM:SENSitivity?			Query only
[SOURce<[1]>:]PM:SOURce	EXT   INT   INT, EXT		
[SOURce<[1]>:]PM:STATe	ON   OFF		

### [SOURce<[1]>:]PM[:DEVIation] 0 ... 20 RAD

The command sets the modulation deviation of the phase modulation in RAD. The maximal deviation depends on the RF frequency set and the selected modulation mode (see data sheet).

**Example:** "PM 5E3"  
'sets the PM modulation deviation to 5 RAD.

*RST value	Resolution	Options	SCPI
1 RAD	See data sheet	Option B22 SOURce2 only with second option B22	Compliant

### [SOURce<[1]>:]PM:EXTernal:COUPLing AC | DC

The command selects the coupling mode for the external modulation input (EXT MOD) in the case of phase modulation.

**Note:**

*Coupling for external feed via input EXT MOD can be set independently for modulations AM, PM and PhiM.*

**Parameters:** **AC**  
The DC voltage component is disconnected from the modulation signal.

**DC**  
The modulation signal is not changed.

**Example:** "PM:EXT:COUP AC"  
'selects the coupling mode AC for external phase modulation.

*RST value	Resolution	Options	SCPI
AC	-	Option B22 SOURce2 only with second option B22	Compliant

[SOURce<[1]]2>:]PM:MODE HBANdwidth | HDEViation | LNOise

The command selects the mode for the phase modulation.

**Parameters: HBANdwidth**

The maximum range for modulation bandwidth is available. However, phase noise is increased for low frequencies. The range for PhiM deviation is limited. This mode is recommended for high modulation frequencies.

**HDEViation**

The maximum range for PhiM deviation is available. Phase noise is improved for low frequencies. The range for modulation frequency is limited (see data sheet). This mode is recommended for low modulation frequencies and/or high PhiM deviation.

**LNOise**

Phase modulation with phase noise and spurious characteristics close to CW mode. The range for modulation bandwidth and PM deviation is limited (see data sheet)

**Example:** "PM:MODE LNO"  
'selects Low Noise mode for external phase modulation.

*RST value	Resolution	Options	SCPI
HBANdwidth	-	Option B22 SOURce2 only with second option B22	Compliant

[SOURce<[1]]2>:]PM:SENSitivity?

The command queries the input sensitivity of the EXT MOD input in RAD/V. The command is only effective if the external modulation source is selected (SOUR:PM:SOUR EXT). The returned value depends on the modulation deviation setting (SOUR:PM:DEVIation). This value is assigned to the voltage value for full modulation of the input.

The command is a query command and therefore has no \*RST value.

**Example:** "PM:DEV 1"  
'sets a modulation deviation of 1RAD.  
"PM:SENS?"  
'queries the input sensitivity at the EXT MOD input.

Response: "1"  
'since the voltage value for full modulation is 1V, the resulting sensitivity is precisely 1RAD/V.

*RST value	Resolution	Options	SCPI
-	-	Option B22 SOURce2 only with second option B22	Compliant

[SOURce<[1]|2>:]PM:SOURce EXT | INT | INT,EXT

The command selects the modulation source for phase modulation. INT is the LF generator. The frequency of the internal modulation signal can be set in the SOURce:LFOOutput subsystem. The external signal is input at the EXT MOD connector. Internal and external modulation source can be selected at the same time.

**Example:** "PM:SOUR INT"  
'selects the internal modulation source.

*RST value	Resolution	Options	SCPI
INTernal	-	Option B22 SOURce2 only with second option B22	Compliant

[SOURce<[1]|2>:]PM:STATe ON | OFFT

The command activates/deactivates phase modulation.

Activation of phase modulation deactivates phase modulation.

**Example:** "PM:STAT ON"  
'activates PM modulation.

*RST value	Resolution	Options	Correlation	SCPI
OFF	-	Option B22 SOURce2 only with and second option B22	PM:STATe ON deactivates phase modulation.	Compliant

# SOURce:POWer Subsystem

This subsystem contains the commands for setting the output level, level control and level correction of the RF signal. Other units can also be used instead of dBm:

by entering the unit directly after the numerical value (example :POW 0.5V),

by changing the DEFault unit in the UNIT system (see the command UNIT:POWER).

In the case of two-path instruments with a second RF path (option R&S SMATE-B20x), the numerical suffix under SOURce distinguishes between RF output A and RF output B:

SOURce[1] = RF output A

SOURce2 = RF output B

The keyword SOURce is optional with commands for RF output A and can be omitted. For RF output B, the command must contain the keyword together with the suffix 2.

Command	Parameters	Default unit	Remark
[SOURce<[1] 2>:]POWer:ALC:OMODE	SHOLd		
[SOURce<[1] 2>:]POWer:ALC:SONCe			No query
[SOURce<[1] 2>:]POWer:ALC[:STATe]	ON   OFF   AUTO		
[SOURce<[1] 2>:]POWer:[LEVEL][:IMMediate][:AMPLitude]	<numeric_value>	dBm	Depending on model
[SOURce<[1] 2>:]POWer:[LEVEL][:IMMediate]:OFFSet	-100 ...+100 dB	dB	Depending on model
[SOURce<[1] 2>:]POWer:[LEVEL][:IMMediate]:RCL	INCLude   EXCLude		
[SOURce<[1] 2>:]POWer:LIMit[:AMPLitude]	<numeric_value>	dBm	Depending on model
[SOURce<[1] 2>:]POWer:MANual	<numeric_value>	dBm	Depending on model
[SOURce<[1] 2>:]POWer:MODE	FIXed CW   SWEEp   LIST		
[SOURce<[1] 2>:]POWer:PEP?		dBm	Query only
[SOURce<[1] 2>:]POWer:START	<numeric_value>	dBm	Depending on model
[SOURce<[1] 2>:]POWer:STEP[:INCRement]	0 ...100 dB	dB	
[SOURce<[1] 2>:]POWer:STEP:MODE	USER   DECimal		
[SOURce<[1] 2>:]POWer:STOP	<numeric_value>	dBm	Depending on model

**[SOURce<[1]|2>:]POWer:ALC:OMODe SHOLd**

The command sets the level control mode which becomes active when automatic level control is deactivated (**ALC Off**).

**Parameter:**       **SHOLd**  
                           Level control is activated briefly if the level or frequency changes (**ALC Off Sample & Hold**).

**Example:**        "POW:ALC OFF"  
                           'deactivates automatic level control for RF output A.

"POW:ALC:OMOD SHOL"  
                           'level control is briefly activated if the frequency or level changes.

*RST value	Resolution	Options	SCPI
SHOLd		SOURce2 only with option B20x	Device-specific

**[SOURce<[1]|2>:]POWer:ALC:SONCe**

The command briefly activates level control for correction purposes.

The command triggers an event and therefore has no \*RST value and no query form.

**Example:**        "POW:ALC OFF"  
                           'deactivates automatic level control for RF output A.

"POW:ALC:SONC"  
                           'level control is performed once only.

*RST value	Resolution	Options	SCPI
-	-	SOURce2 only with option B20x	Device-specific

**[SOURce<[1]|2>:]POWer:ALC[:STATe] ON | OFF | AUTO**

The command activates/deactivates automatic level control.

**Parameters:**    **ON**  
                           internal level control is permanently activated.

**OFF**  
                           internal level control is deactivated, Sample & Hold mode is activated.

**AUTO**  
                           internal level control is activated/deactivated automatically depending on the operating state.

**Example:**        "POW:ALC ON"  
                           'activates automatic level control for RF output A.

*RST value	Resolution	Options	SCPI
AUTO	-	SOURce2 only with option B20x	Compliant

**[SOURce<[1]|2>:]POWer[:LEVel][:IMMediate][:AMPLitude]** Minimum level ... Maximal level

The command sets the RF output level in CW mode. In addition to numerical values, it is also possible to specify UP and DOWN. The level is then increased or decreased by the value specified under [SOURce<[1]|2>:]POWer:STEP.

As with the **Level** value entered in the header, the **OFFSet** value is also taken into consideration with this command.

The specified value range is therefore only effective if :SOURce:POWer:OFFSet is set to 0. The value range for other OFFSet values can be calculated using the following formula:

$$\text{Minimum level} + \text{OFFSet} \dots \text{Maximum level} + \text{OFFSet}$$

The keywords of this command are largely optional. Therefore, both the long and short form of the command are shown in the example.

**Parameters: Minimum level ... Maximum level**

The value range for the level setting varies according to the instrument model and depending on whether or not the instrument has the **High Power option**. The values are given in the data sheet.

**Example:** "SOUR:POW:LEV:IMM:AMPL 15" or ":POW 15"  
'sets the RF level at output A to 15 dBm.

*RST value	Resolution	Options	SCPI
-30 dBm	0.01 dB	SOURce2 only with option B20x	Compliant

**[SOURce<[1]|2>:]POWer[:LEVel][:IMMediate]:OFFSet** -100 dB ... +100 dB

**Caution:**

*The level offset is also effective for level sweeps!*

The command specifies the constant level offset of a downstream attenuator/amplifier. If a level offset is entered, the level entered with :POWer no longer corresponds to the RF output level. The following correlation applies:

$$:\text{POWer} = \text{RF output level} + \text{POWer:OFFSet}.$$

Entering a level offset does not change the RF output level, but rather the query value of :POWer.

Only dB is permitted as the unit here. The linear units (V, W, etc.) are not permitted.

The keywords of this command are largely optional. Therefore, both the long and short form of the command are shown in the example.

**Example:** "SOURce:POWer:LEVel:IMMediate:OFFSet -10"  
or  
"POW:OFFS 10"  
'sets the RF level offset to 10 dB.

*RST value	Resolution	Options	SCPI
0 dB	0.01 dB	SOURce2 only with option B20x	Compliant

**[SOURce:]POWer[:LEVel][:IMMediate]:RCL INCLude | EXCLude**

The command determines whether the current level is retained or whether the stored level setting is adopted when an instrument configuration is loaded.

\*RST does not affect this setting. The setting is valid for both paths. If a suffix is specified, it is ignored.

**Parameters: INCLude**

The stored level is also loaded when a stored instrument configuration is loaded.

**EXCLude**

The RF level is not loaded when a stored instrument configuration is loaded. The current level is retained.

**Example:**

"POW:RCL INCL"

'the stored level is set if the Recall command is called.

*RST value	Resolution	Options	SCPI
-	-	SOURce2 only with option B20x	Compliant

**[SOURce<[1]|2>:]POWer:LIMit[:AMPLitude] Minimum level .... Maximum level**

The command limits the maximum RF output level in CW and SWEEP mode. It does not influence the LEVEL display or the response to the POW? query command.

**Parameters: Minimum level ... Maximum level**

The value range for the level setting varies according to the instrument model and depending on whether or not the instrument has the **High Power option**. The values are given in the data sheet.

**Example:**

"SOURce:POWer:LIMit:AMPLitude 10" or ":POW:LIM 10"

'limits the RF level to maximum +10 dBm.

*RST value	Resolution	Options	SCPI
+30 dBm	0.01 dB	SOURce2 only with option B20x	Compliant

**[SOURce<[1]2>:]POWer:MANual** Minimum level ... Maximum level

In Sweep mode (:SOUR:POW:MODE SWE) the command sets the level for the next sweep step in the **Step** sweep mode (:SOUR:SWE:POW:MODE MAN). Here only level values between the settings [:SOUR]:POW:STAR and ...:STOP are permitted. Each sweep step is triggered by a separate :SOUR:POW:MAN command.

As with the **Level** value entered in the **RF Level** menu, the OFFSet value is also taken into consideration with this command.

The specified value range is therefore only effective if :SOURce:POWer:OFFSet is set to 0. The value range for other OFFset values can be calculated using the following formula:

Minimum level + OFFSet ... Maximum level + OFFSet

**Parameters: Minimum level ... Maximum level**

The value range for the level setting varies according to the instrument model and depending on whether or not the instrument has the **High Power option**. The values are given in the data sheet.

**Example:**

"POW:SWE:MODE MAN"

'sets the **Step** sweep mode for RF output A.

"POW:MAN -5 dBm"

'sets an RF level of -5 dBm for the next setting in the **Step** sweep mode for RF output A.

"POW:MODE SWE"

'sets the Level Sweep mode for RF output A.

"POW:MAN -5.5 dBm"

'triggers the next sweep step with a level of -5.5 dBm.

*RST value	Resolution	Options	SCPI
-30 dBm	0.01 dBm	SOURce2 only with option B20x	Compliant



[SOURce<[1]|2>:]POWer:MODE CW|FIXed | SWEep | LIST

The command sets the instrument operating mode and therefore also the commands used to set the output level.

**Parameters:** CW|FIXed

The instrument operates at a constant level for the selected path. CW and FIXed are synonyms. The output level is set with :SOURce:POWer.

**SWEep**

The instrument operates in SWEep mode for the selected path. The level is set using the commands SOURce:POWer:STARt; STOP; MANual.

**LIST**

The instrument processes a list of frequency and level settings for the selected path. The List mode settings are made in the SOURce:LIST subsystem. The setting SOURce:POWer:MODE LIST also sets the command SOURce:FREQuency:MODE automatically to LIST.

**Example:**

"POW:MODE SWEep"  
 'sets the SWEep mode for Path A. The settings under SOURce:POW:STARt; STOP; MANual become effective.

*RST value	Resolution	Options	Correlation	SCPI
CW	-	SOURce2 only with option B20x	POW:MODE LIST sets FREQ:MODE LIST	Compliant

[SOURce<[1]|2>:]POWer:PEP?

With digital modulation and all digital standards, the command returns the peak envelope power (PEP) in dBm (the value which is shown under the **Level** specification in the PEP lines in the display header).

The command is a query and therefore has no \*RST value.

**Example:**

"POW:PEP?"  
 'queries the PEP value for RF output A in the case of digital modulation.

Response: "4"  
 'the PEP value for RF output A is 4 dBm.

*RST value	Resolution	Options	SCPI
--	-	B13 and B10/B11 SOURce2 only with options B20x and second B13	Compliant

[SOURce<[1]|2>:]POWer:STARt Minimum level ... Maximum level

The command sets the RF start level in Sweep mode.

As with the **Level** value entered in the **RF Level** menu, the **OFFSet** value is also taken into consideration with this command.

The specified value range is therefore only effective if :SOURce:POWer:OFFSet is set to 0. The value range for other OFFSet values can be calculated using the following formula:

Minimum level + OFFSet ...Maximum level + OFFSet

**Parameters: Minimum level ... Maximum level**

The value range for the level setting varies according to the instrument model and depending on whether or not the instrument has the **High Power option**. The values are given in the data sheet.

**Example:** "POW:STAR -20 dBm"  
'sets the start level for the level sweep to -15 dBm for RF output A.

*RST value	Resolution	Options	SCPI
-30 dBm	0.01 dB	SOURce2 only with option B20x	Compliant

[SOURce<[1]|2>:]POWer:STEP[:INCRement] 0 dB ... 100dB

The command sets the step width for the level setting if UP and DOWN are used as the level values and variation mode :SOUR:POW:STEP:MODE USER is selected. The command is linked to setting **Variation Step** for manual control, i.e. the command also sets the step width of the rotary knob for **Variation Active on**. In the case of two-path instruments, the step width can be set separately for each path.

**Example:** "SOURce:POWer:STEP:INCRement 2" or "POW:STEP 2"  
'sets the step width for entering the RF level to 2 dB.

*RST value	Resolution	Options	SCPI
1 dB	0.01 dB	SOURce2 only with option B20x	Device-specific

[SOURce<[1]|2>:]POWer:STEP:MODE USER | DECimal

This command activates (USER) or deactivates (DECimal) the user-defined step width used when varying the level value with the level values UP/DOWN. The command is linked to setting **Variation Active** for manual control, i.e. the command also activates/deactivates the user-defined step width used when varying the level value with the rotary knob. In the case of two-path instruments, the step width can be set separately for each path.

**Example:** "POW:STEP 2"  
'sets the step width for the level setting to 2 dB.

"POW:STEP:MODE USER"  
'activates this step width for level variation with the rotary knob (manual control) and with level values UP/DOWN (remote control).

*RST value	Resolution	Options	SCPI
DECimal	-	SOURce2 only with option B20x	Device-specific

**[SOURce<[1]|2>:]POWer:STOP** Minimum level ... Maximum level

The command sets the stop level in Sweep mode.

As with the **Level** value entered in the **RF Level** menu, the **OFFSet** value is also taken into consideration with this command.

The specified value range is therefore only effective if :SOURce:POWer:OFFSet is set to 0. The value range for other OFFset values can be calculated using the following formula:

$$\text{Minimum level} + \text{OFFSet} \quad \dots \quad \text{Maximum level} + \text{OFFSet}$$

**Parameters: Minimum level ... Maximum level**

The value range for the level setting varies according to the instrument model and depending on whether or not the instrument has the **High Power option**. The values are given in the data sheet.

**Example:** "POW:STOP 3"  
 'sets the stop level for the level sweep to 3 dBm for RF output A.

*RST value	Resolution	Options	SCPI
-10 dBm	0.01 dB	SOURce2 only with option B20x	Compliant

# SOURce:PULM Subsystem

This subsystem contains the commands for setting the pulse modulation.

The LF generator is used as the internal modulation source. The pulse frequency of the internal rectangular signal is therefore set in the SOURce:LFOOutput subsystem.

The external modulation signal is input at the EXT MOD connector at the rear of the R&S Vector Signal Generator.

In the case of two-path instruments with a second RF path (option R&S SMATE-B20x), the pulse modulation can be set separately and independently for the two RF outputs. The suffix under SOURce distinguishes the outputs:

SOURce[1] = RF output A

SOURce2 = RF output B

The keyword SOURce is optional with commands for RF output A and can be omitted. For RF output B, the command must contain the keyword together with the suffix 2.

Command	Parameters	Default unit	Remark
[SOURce<[1] 2>:]PULM:POLarity	NORMal   INVerted		
[SOURce<[1] 2>:]PULM:SOURce	INT   EXT		
[SOURce<[1] 2>:]PULM:STATe	ON   OFF		

## [SOURce<[1]|2>:]PULM:POLarity NORMal | INVerted

The command sets the polarity between modulating and modulated signal. This command is only effective for an external modulation signal.

**Parameters:**     **NORMal**

The RF signal is suppressed during the pulse pause.

**INVerted**

The RF signal is suppressed during the pulse.

**Example:**

"PULM:SOUR EXT"

'selects the external modulation source.

"PULM:POL INV"

'selects inverted polarity.

*RST value	Resolution	Options	SCPI
NORMal	-	SOURce2 only with option B20x	Device-specific

[SOURce<[1]|2>:]PULM:SOURce INTernal | EXTernal | CODer

The command selects the source for pulse modulation.

**Parameters:**     **INTernal**

The internally generated rectangular signal is used for the pulse modulation. The frequency of the internal signal can be set in the SOURce:LFOuTput subsystem.

**EXTernal**

The signal applied externally via the EXT MOD connector is used for the pulse modulation.

**Example:**        "PULM:SOUR INT"  
                      'selects the internal modulation source.

"PULM:STAT ON"  
                      'activates the pulse modulation.

*RST value	Resolution	Options	SCPI
INTernal	-	SOURce2 only with option B20x	Compliant

[SOURce<[1]|2>:]PULM:STATe ON | OFF

The command activates/deactivates the pulse modulation.

**Example:**        "PULM:STAT ON"  
                      'activates pulse modulation with the modulation source selected under SOURce:PULM:SOURce.

*RST value	Resolution	Options	SCPI
OFF	-	SOURce2 only with option B20x	Compliant

# SOURce:ROSCillator Subsystem

This subsystem contains the commands for setting the external and internal reference frequency.

In the case of two-path instruments, this setting is effective for all paths. No suffix should therefore be specified under SOURce.

Command	Parameters	Default unit	Remark
[SOURce:]ROSCillator:EXternal:FREQuency	5 MHz   10 MHz   13 MHz	Hz	
[SOURce:]ROSCillator:EXternal:SBANdwidth			
[SOURce:]ROSCillator[:INternal]:ADJust[:STATe]	ON   OFF		
[SOURce:]ROSCillator[:INternal]:ADJust:VALue	0 ... 4095		
[SOURce:]ROSCillator:SOURce	INternal   EXternal		

## [SOURce:]ROSCillator:EXternal:FREQuency 5 MHz | 10 MHz | 13 MHz

The command informs the instrument of the frequency of the external reference.

**Example:** "ROSC:SOUR EXT"  
'selects the external source. The reference must be input at the REF IN input.

"ROSC:EXT:FREQ 5 MHz"  
'informs the instrument that the external reference frequency is 5 MHz'.

*RST value	Resolution	Options	SCPI
10 MHz	-	-	Compliant

## [SOURce:]ROSCillator:EXternal:SBANdwidth NARRow | WIDe

The command selects the synchronization bandwidth for an external reference signal.

**Parameters:** **NARRow**  
Synchronization bandwidth is approx. 1 Hz.

**WIDe**  
Synchronization bandwidth is approx. 750 Hz

**Example:** "ROSC:SOUR EXT"  
'selects the external source.

"ROSC:EXT:FREQ 5 MHz"  
'informs the instrument that the external reference has a frequency of 5 MHz.

"ROSC:EXT:SBAN WID"  
'selects wideband setting for synchronization bandwidth.

*RST value	Resolution	Options	SCPI
NARRow	-	-	Device-specific

**[SOURce:]ROSCillator[:INTernal]:ADJust:VALue 0 ... 4095**

The command specifies the frequency correction value (adjustment value).

**Example:**       "ROSC:ADJ:VAL 1400"  
                      'sets the adjustment value to 1400.

*RST value	Resolution	Options	SCPI
1400	1		Device-specific

**[SOURce:]ROSCillator[:INTernal]:ADJust[:STATe] ON | OFF**

The command determines whether the calibrated (OFF) or a user-defined (ON) adjustment value is used for fine adjustment of the frequency. With STATE ON, the instrument is no longer in the calibrated state.

**Example:**       "ROSC:SOUR INT"  
                      'selects the internal source.  
  
                      "ROSC:ADJ ON"  
                      'activates use of a user-defined adjustment value.  
  
                      "ROSC:ADJ:VAL 1400"  
                      'sets the adjustment value to 1400.

*RST value	Resolution	Options	SCPI
OFF	-	-	Device-specific

**[SOURce:]ROSCillator:SOURce INTernal | EXTernal**

The command selects between internal and external reference frequency.

**Parameters:**   **INTernal**  
                      The internal reference oscillator is used.

**EXTernal**  
An external reference signal is used. It must be input at the REF IN connector at the rear of the instrument. The instrument is informed of the frequency of the external reference signal by means of the command  
SOURce:ROSCillator:EXTernal:FREQuency.

**Example:**       "ROSC:SOUR EXT"  
                      'selects the external source.  
  
                      "ROSC:EXT:FREQ 5 MHz"  
                      'informs the instrument that the external reference has a frequency of 5 MHz.

*RST value	Resolution	Options	SCPI
INTernal	-	-	Device-specific

# SOURce:SWEep Subsystem

This subsystem contains the commands for checking the RF sweeps, i.e. the sweeps of the RF generators. Sweeps are always triggered, except for the **MANual** sweep mode. The frequency sweep is activated by the command `SOURce:FREQuency:MODE SWEep`, and the level sweep by the command `SOURce:POWer:MODE SWEep`. All sweeps, including the LF sweep, can be set independently of each other.

In the case of two-path instruments with a second RF path (option R&S SMATE-B20x), the numerical suffix under `SOURce` distinguishes between RF output A and RF output B:

`SOURce<1>` = RF output A  
`SOURce2` = RF output B

The keyword `SOURce` is optional with commands for RF output A and can be omitted. For RF output B, the command must contain the keyword together with the suffix 2.

A sweep is set in several steps which are shown below taking a frequency sweep as an example:

1. Set the sweep range.

```
[SOURce<[1]|2>:]FREQuency:CENTer 200 MHz
[SOURce<[1]|2>:]FREQuency:SPAN 300 MHz
```

2. Select linear or logarithmic spacing.

```
[SOURce<[1]|2>:]SWEep[:FREQuency]:SPACing LIN
```

3. Set the step width and dwell time.

```
[SOURce<[1]|2>:]SWEep[:FREQuency]:STEP:LINear 20 MHz
[SOURce<[1]|2>:]SWEep[:FREQuency]:DWELl 12 ms
```

4. Select the trigger mode.

```
TRIGger<[1]|2>:FSWEEP:SOURce SINGLE
```

5. Select the sweep mode and activate the sweep.

```
[SOURce<[1]|2>:]SWEep[:FREQuency]:MODE AUTO
[SOURce<[1]|2>:]FREQuency:MODE SWEep
```

6. Trigger the sweep.

```
[SOURce<[1]|2>:]SWEep[:FREQuency]:EXECute
```

Command	Parameters	Default unit	Remark
[SOURce<[1] 2>:]SWEep[:FREQuency]:DWELl	2 ms ... 10 s	s	
[SOURce<[1] 2>:]SWEep[:FREQuency]:EXECute	-		
[SOURce<[1] 2>:]SWEep[:FREQuency]:MODE	AUTO   MANual   STEP		
[SOURce<[1] 2>:]SWEep[:FREQuency]:POINts	<numeric_value>		
[SOURce<[1] 2>:]SWEep[:FREQuency]:SPACing	LINear   LOGarithmic		
[SOURce<[1] 2>:]SWEep[:FREQuency]:STEP:LINear]	0 ... (STOP - START)	Hz	
[SOURce<[1] 2>:]SWEep[:FREQuency]:STEP:LOGarithmic	0.01 ... 9999 PCT		
[SOURce<[1] 2>:]SWEep:POWer:AMODe	NORMal   HPOWer		
[SOURce<[1] 2>:]SWEep:POWer:DWELl	2 ms...10 s	s	
[SOURce<[1] 2>:]SWEep:POWer:EXECute	-		
[SOURce<[1] 2>:]SWEep:POWer:MODE	AUTO   MANual   STEP		
[SOURce<[1] 2>:]SWEep:POWer:POINts	<numeric_value>		



[SOURce<[1]]2>:]SWEep:POWer:SPACing:MODE			Query only
[SOURce<[1]]2>:]SWEep:POWer:STEP[:LOGarithmic]	0.1 ...20 dB		
[SOURce<[1]]2>:]SWEep:RESet[:ALL]			No query

**[SOURce<[1]]2>:]SWEep[:FREQuency]:DWELI 3 ms...10 s**

The command sets the time taken for each frequency step of the sweep.

The keyword [ :FREQuency] can be omitted (see example). The command is then SCPI-compliant.

**Example:** "SWE:DWEL 12 ms"  
 'sets a dwell time of 12 ms for a frequency sweep at RF output A.

*RST value	Resolution	Options	SCPI
10 ms	0.1 ms	SOURce2 only with option B20x	Device-specific

**[SOURce<[1]]2>:]SWEep[:FREQuency]:EXECute**

The command triggers a sweep.

The command triggers an event and therefore has no query form and no \*RST value.

**Example:** "SWE:FREQ:EXEC"  
 'triggers a frequency sweep at RF output A.

*RST value	Resolution	Options	SCPI
-	-	SOURce2 only with option B20x	Device-specific

**[SOURce<[1]|2>:SWEep[:FREQuency]:MODE** AUTO | MANual | STEP

The command sets the sweep mode.

The keyword [ :FREQuency] can be omitted (see example). The command is then SCPI-compliant.

**Parameters:**     **AUTO**  
                       Each trigger triggers exactly one complete sweep.

**MANual**  
 The trigger system is not active. Each frequency step of the sweep is triggered individually, either by varying the **Current Frequency** value using the rotary knob under manual control or by means of a `FREQ:MAN` command under remote control. With manual control, the frequency increases or decreases (depending on the direction of the rotary encoder) by the value specified under `FREQ:STEP:INCRement`. With remote control, the frequency is set directly with the command `:FREQ:MAN`.

**STEP**  
 Each trigger triggers one sweep step only (**Mode Single Step**). The frequency increases by the value entered under `SOUR:SWE:FREQ:STEP:LIN` (linear spacing) or `...:STEP:LOG` (logarithmic spacing).

**Example:**         " SWE:MODE AUTO"  
                       'selects **Mode Auto** for a frequency sweep at RF output A.

*RST value	Resolution	Options	SCPI
AUTO	-	SOURce2 only with option B20x	Device-specific

**[SOURce<[1]|2>:SWEep[:FREQuency]:POINTs** <numeric\_value>

The command sets the number of steps in an RF sweep. The command is linked to the command `:SWEep[:FREQuency]:STEP` as follows:

The following applies for linear sweeps:      $POINTs = (SPAN / STEP:LIN) + 1$

The following applies for logarithmic sweeps and `START < STOP`:  
 $POINTs = ((\log STOP - \log START) / \log STEP:LOG) + 1$

If `POINTs` changes, the value of `STEP` is adjusted. The `START` and `STOP` value is retained.

Two separate `POINTs` values are used for linear or logarithmic sweep spacing (`:SWEep[:FREQuency]:SPACing LIN | LOG`). The command is always effective for the currently set sweep spacing.

**Example:**         " FREQ:STAR"  
                       'sets the start frequency to 100 MHz.  
                       " FREQ:STOP"  
                       'sets the stop frequency to 500 MHz.  
                       " SWE:SPAC LIN"  
                       'sets linear sweep spacing.  
                       " SWE:POIN 401"  
                       'sets 401 sweep steps for linear sweep spacing. The sweep step width (`STEP`) is automatically set to 1 MHz.

*RST value	Resolution	Options	Correlation	SCPI
	-	SOURce2 only with option B20x	The value of <code>:SWE:STEP</code> is adjusted automatically.	Device-specific (adapted to instrument properties)

[SOURce<[1]|2>:]SWEep[:FREQuency]:SPACing LINear | LOGarithmic

The command selects linear or logarithmic sweep spacing.

The keyword [:FREQuency] can be omitted (see example). The command is then SCPI-compliant.

**Example:** "SWE:SPAC LIN"  
 'selects linear sweep spacing for a frequency sweep at RF output A.

*RST value	Resolution	Options	SCPI
LIN	-	SOURce2 only with option B20x	Device-specific

[SOURce<[1]|2>:]SWEep[:FREQuency]:STEP[:LINear] 0 ... (STOP - START)

The command sets the step width for linear sweeps.

This command is linked to the command :SWEep[:FREQuency]:POINTs as follows:

$$POINTs = (SPAN / STEP:LIN) + 1$$

If STEP:LIN changes, the value of POINTs is adjusted. The START and STOP value is retained.

The keywords [:FREQuency] and [:LINear] can be omitted (see example). The command is then SCPI-compliant.

**Example:** "FREQ:STAR"  
 'sets the start frequency to 100 MHz.  
 "FREQ:STOP"  
 'sets the stop frequency to 500 MHz.  
 "SWE:SPAC LIN"  
 'sets linear sweep spacing.  
 "SWE:STEP 2 MHz"  
 'sets the step width for linear sweep spacing to 2 MHz (RF sweep at RF output A). The number of sweep steps for linear sweep spacing (POINTs) is automatically set to 201.

*RST value	Resolution	Options	Correlation	SCPI
1 MHz	0.1 Hz.	SOURce2 only with option B20x	The value of :SWE:POINTs is adjusted automatically.	Device-specific

**[SOURce<[1]|2>:]SWEep[:FREQuency]:STEP:LOGarithmic 0.01 ... 9999 PCT**

The command specifies the step width factor for logarithmic sweeps. The next frequency value of a sweep is calculated (for START < STOP) using the following formula:

$$\text{New frequency} = \text{Old frequency} + \text{STEP:LOG} \times \text{Old frequency}$$

STEP:LOG therefore gives the fraction of the old frequency. The frequency is increased by this fraction for the next sweep step. Usually STEP:LOG is given in percent, whereby the suffix PCT must always be used.

The command is linked to the command :SWEep[:FREQuency]:POINTs for START < STOP as follows:

$$\text{POINTs} = ((\log \text{STOP} - \log \text{START}) / \log \text{STEP:LOG}) + 1$$

If STEP:LOG changes, the value of POINTs is adjusted. The START and STOP value is retained.

**Example:** "FREQ:STAR"  
'sets the start frequency to 100 MHz.  
"FREQ:STOP"  
'sets the stop frequency to 500 MHz.  
"SWE:SPAC LOG"  
'sets logarithmic sweep spacing.  
"SWE:STEP:LOG 10PCT"  
'sets the step width for logarithmic sweep spacing to 10% of the previous frequency in each instance (for a frequency sweep at RF output A).

*RST value	Resolution	Options	Correlation	SCPI
1 PCT	0.01 PCT	SOURce2 only with option B20x	The value of :SWE:POIN is adjusted automatically.	Device-specific

**[SOURce<[1]|2>:]SWEep:POWer:AMODe NORMal | HPOWer**

The command selects the ranges of level settings for the level sweep. The sweep is either performed in the low level or in the high level ranges.

**Parameters:** **NORMal**  
**With Option High Power only:** The level settings are made in the range of the electronically switching attenuator. The high level ranges are not available.

**HPOWer**  
**With Option High Power only:** The level settings are made in the range of the option. Only the high level range is available.

**Example:** "SWE:POW:AMOD HPOW"  
'selects the high level ranges.

*RST value	Resolution	Options	SCPI
NORMal	-	SOURce2 only with option B20x	Device-specific

**[SOURce<[1]|2>:]SWEep:POWer:DWELI 2 ms...10 s**

The command sets the time taken for each level step of the sweep.

**Example:** "SWE:POW:DWEL 12 ms"  
'sets a dwell time of 12 ms for a level sweep at RF output A.

*RST value	Resolution	Options	SCPI
10 ms	0.1 ms	SOURce2 only with option B20x	Device-specific

**[SOURce<[1]|2>:]SWEep:POWer:EXECute**

The command triggers a sweep.

The command triggers an event and therefore has no query form and no \*RST value.

**Example:** "SWE:POW:EXEC"  
'triggers a level sweep at RF output A.

*RST value	Resolution	Options	SCPI
-	-	SOURce2 only with option B20x	Device-specific

**[SOURce<[1]|2>:]SWEep:POWer:MODE AUTO | MANual | STEP**

The command sets the cycle mode of the level sweep.

**Parameters:** **AUTO**  
Each trigger triggers exactly one complete sweep.

**MANual**

The trigger system is not active. Each level step of the sweep is triggered individually, either by varying the **Current Level** value using the rotary knob under manual control or by means of a POW:MAN command under remote control. With manual control, the level increases or decreases (depending on the direction of the rotary encoder) by the value specified under POW:STEP:INCRement. With remote control, the level is set directly with the command POW:MAN.

**STEP**

Each trigger triggers one sweep step only. The level increases by the value entered under :SWEep:POWer:STEP:LOGarithmic.

**Example:** "SWE:POW:MODE AUTO"  
'selects **Mode Auto** for a level sweep at RF output A.

*RST value	Resolution	Options	SCPI
AUTO	-	SOURce2 only with option B20x	Device-specific

[SOURce<[1]|2>:]SWEep:POWer:POINts <numeric\_value>

The command sets the number of steps in a level sweep. The command is linked to the command :SWEep:POWer:STEP as follows:

$$POINTs = ((STOP - START) / STEP:LOG) + 1$$

If POINTs changes, the value of STEP is adjusted. The START and STOP value is retained.

**Example:** "POW:STAR - 30 dBm"  
'sets the start frequency to -30 dBm.  
"POW:STOP - 10 dBm"  
'sets the stop frequency to -10 dBm.  
"SWE:POW:POIN 20"  
'sets 20 sweep steps. The sweep step width (STEP) is automatically set to 1 dB.

*RST value	Resolution	Options	Correlation	SCPI
20 dB	-	SOURce2 only with option B20x	The value of :SWE:POW:STEP is adjusted automatically.	Device-specific (adapted to instrument properties)

[SOURce<[1]|2>:]SWEep:POWer:SPACing:MODE?

The command queries the sweep spacing. The sweep spacing for level sweeps is always linear.

This command is a query command and has no \*RST value.

**Example:** "SWE:POW:SPAC:MODE?"  
'queries the sweep spacing for a level sweep at RF output A.  
Result: "LIN" 'linear spacing.

*RST value	Resolution	Options	SCPI
-	-	SOURce2 only with option B20x	Device-specific

[SOURce<[1]|2>:]SWEep:POWer:STEP[:LOGarithmic] 0.01 ... 165 dB

The command sets the step width factor for logarithmic sweeps. The next level value of a sweep is calculated (for START < STOP) using the following formula:

$$\text{New level} = \text{Old level} + STEP:LOG \times \text{Old level}$$

STEP:LOG therefore gives the fraction of the old level. The level is increased by this fraction for the next sweep step. Usually STEP:LOG is given in decibels, whereby the suffix dB must always be used.

The command is linked to the command :SWEep:POWer:POINts for START < STOP as follows:

$$POINTs = ((STOP - START) / STEP:LOG) + 1$$

If STEP:LOG changes, the value of POINTs is adjusted. The START and STOP value is retained.

**Example:** "SWE:POW:STEP 10dB"  
'sets the step width for logarithmic sweep spacing to 10 dB of the previous level in each instance (for a level sweep at RF output A).

*RST value	Resolution	Options	SCPI
1 dB	0.01 dB	SOURce2 only with option B20x	Device-specific

**[SOURce<[1]|2>:]SWEep:RESet[:ALL]**

The command resets all active sweeps to the starting point.

The command triggers an event and therefore has no reset value.

**Example:**           "SWEEP:RES"  
                          'resets all active sweeps to the starting point.

*RST value	Resolution	Options	SCPI
-	-	SOURce2 only with option B20x	Device-specific

## STATus Subsystem

This system contains the commands for the status reporting system. \*RST has no effect on the status registers.

Queries return the current value of the respective register, which permits a check of the device status. A decimal value between 0 and 32767 ( $=2^{15}-1$ ) is returned.

The configuration commands set the respective register thus determining which status changes of the R&S Vector Signal Generator causes the status registers to be changed. A decimal value between 0 and 32767 ( $=2^{15}-1$ ) is set.

Command	Parameters	Default unit	Remark
STATus:OPERation:CONDition?			Query only
STATus:OPERation:ENABLE	0...32767		
STATus:OPERation[:EVENT]?			Query only
STATus:OPERation:NTRansition	0...32767		
STATus:OPERation:PTRansition	0...32767		
STATus:PRESet			No query
STATus:QUEStionable:CONDition?			Query only
STATus:QUEStionable:ENABLE	0...32767		
STATus:QUEStionable[:EVENT]?			Query only
STATus:QUEStionable:NTRansition	0...32767		
STATus:QUEStionable:PTRansition	0...32767		
STATus:QUEue[:NEXT]?			Query only

**STATus:OPERation:CONDition?**

The command queries the content of the CONDition part of the STATus:OPERation register. This part contains information on the action currently being performed in the instrument. The content is not deleted after being read out since it indicates the current hardware status.

**Example:**           "STAT:OPER:COND?"  
                          'queries the Status:Operation:Condition register.

*RST value	Resolution	Options	SCPI
-	-		Compliant

**STATus:OPERation:ENABLE**

The command sets the bits of the ENABLE part of the STATus:OPERation register. This setting determines which events of the Status-Event part are forwarded to the sum bit in the status byte. These events can be used for a service request.

**Example:**           "STAT:OPER:ENAB 32767"  
                          'all events are forwarded to the sum bit of the status byte.

*RST value	Resolution	Options	SCPI
-	-		Compliant

**STATus:OPERation:EVENT?**

The command queries the content of the EVENT part of the STATus:OPERation register. This part contains information on the actions performed in the instrument since the last readout. The content of the EVENT part is deleted after being read out.

**Example:**           "STAT:OPER:EVENT?"  
                          'queries the STATus:OPERation:EVENT register.

*RST value	Resolution	Options	SCPI
-	-		Compliant

**STATus:OPERation:PTRansition**

The command sets the bits of the PTRansition part of the STATus:OPERation register. If a bit is set, a transition from 0 to 1 in the condition part causes an entry to be made in the EVENT part of the register. A new event in the hardware is thus registered, e.g. the start of an adjustment.

**Example:**           "STAT:OPER:PTR 32767"  
                          'all transitions from 0 to 1 in the condition part of the Status:Operation register cause an entry to be made in the EVENT part.

*RST value	Resolution	Options	SCPI
-	-		Compliant

**STATus:OPERation:NTRansition**

The command sets the bits of the NTRansition part of the STATus:OPERation register. If a bit is set, a transition from 1 to 0 in the condition part causes an entry to be made in the EVENT part of the register. The disappearance of an event in the hardware is thus registered, e.g. the end of an adjustment.

**Example:**           "STAT:OPER:NTR 0"  
                          'a transition from 1 to 0 in the condition part of the Status:Operation register does not cause an entry to be made in the EVENT part.

*RST value	Resolution	Options	SCPI
-	-		Compliant



**STATus:PRESet**

The command resets the status registers. All PTRansition parts are set to FFFFh (32767), i.e. all transitions from 0 to 1 are detected. All NTRansition parts are set to 0, i.e. a transition from 1 to 0 in a CONDition bit is not detected. The ENABLE parts of STATus:OPERation and STATus:QUESTionable are set to 0, i.e. all events in these registers are not passed on.

The command triggers an event and therefore has no query form and no \*RST value.

**Example:**           "STAT:PRESet"  
                          'resets the status registers.

*RST value	Resolution	Options	SCPI
-	-		Compliant

**STATus:QUESTionable:EVENT?**

The command queries the content of the EVENT part of the STATus:QUESTionable register. This part contains information on the actions performed in the instrument since the last readout. The content of the EVENT part is deleted after being read out.

**Example:**           "STAT:OPER:EVENT?"  
                          'queries the Status:Questionable:Event register.

*RST value	Resolution	Options	SCPI
-	-		Compliant

**STATus:QUESTionable:CONDition?**

The command queries the content of the CONDition part of the STATus:QUESTionable register. This part contains information on the action currently being performed in the instrument. The content is not deleted after being read out since it indicates the current hardware status.

**Example:**           "STAT:OPER:COND?"  
                          'queries the Status:Questionable:Condition register.

*RST value	Resolution	Options	SCPI
-	-		Compliant

**STATus:QUESTionable:PTRansition**

The command sets the bits of the PTRansition part of the STATus:QUESTionable register. If a bit is set, a transition from 0 to 1 in the condition part causes an entry to be made in the EVENT part of the register.

**Example:**           "STAT:OPER:PTR 32767"  
                          'all transitions from 0 to 1 in the condition part of the Status:Questionable register cause an entry to be made in the EVENT part.

*RST value	Resolution	Options	SCPI
-	-		Compliant

**STATus:QUESTionable:NTRansition**

The command sets the bits of the NTRansition part of the STATus:QUESTionable register. If a bit is set, a transition from 1 to 0 in the condition part causes an entry to be made in the EVENT part of the register.

**Example:**           "STAT:OPER:NTR 0"  
                           'a transition from 1 to 0 in the condition part of the Status:Questionable register does not cause an entry to be made in the EVENT part.

*RST value	Resolution	Options	SCPI
-	-		Compliant

**STATus:QUESTionable:ENABLE**

The command sets the bits of the ENABLE part of the STATus:QUESTionable register. This setting determines which events of the Status-Event part are enabled for the sum bit in the status byte. These events can be used for a service request.

**Example:**           "STAT:OPER:ENAB 1"  
                           'problems when performing an adjustment cause an entry to be made in the sum bit.

*RST value	Resolution	Options	SCPI
-	-		Compliant

**STATus:QUEue[:NEXT]?**

The command queries the oldest entry in the error queue and then deletes it. Positive error numbers denote device-specific errors, and negative error numbers denote error messages defined by SCPI (see Chapter 9). If the error queue is empty, 0 ("No error") is returned. The command is identical to SYSTem:ERRor?.

**Example:**           "STAT:QUE?"  
                           'queries the oldest entry in the error queue.  
                           Response: "0, 'no error'"  
                           'no errors have occurred since the error queue was last read out.

*RST value	Resolution	Options	SCPI
-	-		Compliant

# SYSTEM Subsystem

The SYSTEM subsystem contains a series of commands for general functions which do not directly affect signal generation.

Command	Parameters	Default unit	Remark
SYSTEM:BEEPer:STATe	ON   OFF		
SYSTEM:COMMunicate:GPIB:LTERminator	EOI   STANdard		
SYSTEM:COMMunicate:GPIB[:SELF]:ADDRess	0...30		
SYSTEM:COMMunicate:NET:RESource	'string'		
SYSTEM:DATE	<year>,<month>,<day>		
SYSTEM:DISPlay:UPDate	ON   OFF		
SYSTEM:ERRor:ALL			Query only
SYSTEM:ERRor:CODE:ALL			Query only
SYSTEM:ERRor:CODE[:NEXT]?			Query only
SYSTEM:ERRor:COUNt?			Query only
SYSTEM:ERRor[:NEXT]?			Query only
SYSTEM:KLOCK	ON   OFF		
SYSTEM:PRESet			No query
SYSTEM:PROTect<n>[:STATe]	ON   OFF , password		
SYSTEM:SECurity[:STATe]	ON   OFF		
SYSTEM:SERRor?			Query only
SYSTEM:TIME	<hour>,<minute>,<second>		
SYSTEM:VERSIon?			Query only

## SYSTEM:BEEPer:STATe ON | OFF

The command switches the key beep on or off.

**Example:** "SYST:BEEP:STAT OFF"  
 'no acoustic signal is output when a key on the front panel is pressed.

*RST value	Resolution	Options	SCPI
OFF	-		Compliant

**SYSTEM:COMMunicate:GPIB:LTERminator** EOI | STANdard

The command sets the terminator recognition for remote control via the IEC/IEEE bus.

**Parameters:** EOI

The terminator must be sent together with the line message EOI (End of Line). This setting is recommended for binary block transmissions where a character could coincidentally have the value LF (Line Feed) but is not intended as the terminator. This setting must be selected for block data with undefined length.

**STANdard**

An LF (Line Feed) is recognized as the terminator regardless of whether it is sent with or without EOI.

**Example:**

"SYST:COMM:GPIB:LTER EOI"

'only a character which is sent simultaneously with the line message EOI is accepted as the terminator.

*RST value	Resolution	Options	SCPI
STANdard	-		Compliant

**SYSTEM:COMMunicate:GPIB[:SELF]:ADDRess** 1 ... 30

The command sets the IEC/IEEE-bus address.

**Example:**

"SYST:COMM:GPIB:ADDR 14"

'sets IEC/IEEE-bus address 14.

*RST value	Resolution	Options	SCPI
28	-		Compliant

**SYSTEM:COMMunicate:NET:RESource?**

The command queries the visa resource string. This string is used for remote control of the instrument.

The command is a query command and therefore has no \*RST value.

**Example:**

SYST:COMM:NET:RES?

'queries the VISA resource string.

Response:

TCPIP::192.1.1.2.3::INSTR

*RST value	Resolution	Options	SCPI
	-		Device-specific

**SYSTEM:DATE** <year>,<month>,<day>

The command sets the date for the instrument-internal calendar.

**Example:**       "SYST:DATE 2003,05,01"  
                  'sets May 1, 2003.

*RST value	Resolution	Options	SCPI
-	-		Compliant

**SYSTEM:DISPlay:UPDate** ON | OFF

The command switches the update of the display on/off. A switchover from remote control to manual control always sets the status of the update of the display to ON.

**Example:**       "SYST:DISP:UPD OFF"  
                  'switches update of displayed parameter values off.

*RST value	Resolution	Options	SCPI
-	-		Device-specific

**SYSTEM:ERRor:ALL?**

The command queries all entries in the error queue and then deletes them. Positive error numbers denote device-specific errors, and negative error numbers denote error messages defined by SCPI. If the error queue is empty, 0 ("No error") is returned.

The command is a query command and therefore has no \*RST value.

**Example:**       "SYST:ERR:ALL?"  
                  'queries all entries in the error queue.

Response: "0, 'no error'"  
          'no errors have occurred since the error queue was last read out.

*RST value	Resolution	Options	SCPI
-	-		Compliant

**SYSTEM:ERRor:CODE:ALL?**

The command queries all entries in the error queue and then deletes them. Only the error numbers are returned and not the entire error text. Positive error numbers denote device-specific errors, and negative error numbers denote error messages defined by SCPI (see chapter 9, section "[Error Messages](#)"). If the error queue is empty, 0 ("No error") is returned.

The command is a query command and therefore has no \*RST value.

**Example:**       "SYST:ERR:CODE:ALL?"  
                  'queries all entries in the error queue.

Response: "0"  
          'no errors have occurred since the error queue was last read out.

*RST value	Resolution	Options	SCPI
-	-		Compliant

**SYSTEM:ERRor:CODE[:NEXT]?**

The command queries the oldest entry in the error queue and then deletes it. Only the error number is returned and not the entire error text. Positive error numbers denote device-specific errors, and negative error numbers denote error messages defined by SCPI (see chapter 9, section "Error Messages"). If the error queue is empty, 0 is returned.

The command is a query command and therefore has no \*RST value.

**Example:**           "SYST:ERR:CODE?"  
                          'queries the oldest entry in the error queue.

Response: "0"  
                          'no errors have occurred since the error queue was last read out.

*RST value	Resolution	Options	SCPI
-	-		Compliant

**SYSTEM:ERRor:COUNt?**

The command queries the number of entries in the error queue. If the error queue is empty, '0' is returned.

The command is a query command and therefore has no \*RST value.

**Example:**           "SYST:ERR:CODE?"  
                          'queries the oldest entry in the error queue.

Response: "1"  
                          'one error has occurred since the error queue was last read out.

*RST value	Resolution	Options	SCPI
-	-		Compliant

**SYSTEM:ERRor[:NEXT]?**

The command queries the oldest entry in the error queue and then deletes it. Positive error numbers denote device-specific errors, and negative error numbers denote error messages defined by SCPI (see Chapter 9). If the error queue is empty, 0 ("No error") is returned. The command is identical to the command `STATus:QUEue:NEXT?`.

The command is a query command and therefore has no \*RST value.

**Example:**           "SYST:ERR?"  
                          'queries the oldest entry in the error queue.

Response: "0, 'no error'"  
                          'no errors have occurred since the error queue was last read out.

*RST value	Resolution	Options	SCPI
-	-		Compliant

**SYSTEM:KLOCK ON | OFF**

The command (Keyboard LOCK) disables the front panel keyboard of the R&S Vector Signal Generator including the LOCAL key, or enables it again (OFF).

**Example:** "SYST:KLOC ON"  
'activates the keyboard lock. The keyboard cannot be operated again until it has been enabled with SYST:KLOC OFF.

*RST value	Resolution	Options	SCPI
OFF	-		Compliant

**SYSTEM:PRESet**

The command triggers an instrument reset. It has the same effect as the PRESET key on the front panel and the \*RST command.

The command triggers an event and therefore has no \*RST value and no query form.

**Example:** "SYST:PRES"  
'all instrument settings (also those that are not currently active) are reset to their default values.

*RST value	Resolution	Options	SCPI
-	-		Compliant

**SYSTEM:PROTect<n>[:STATe] ON | OFF, password**

The command activates and deactivates the specified protection level. There are several protection levels which disable specific service functions (authorized personnel of R&S Service Departments only). These levels are identified by the suffix under PROTect.

The respective functions are disabled when the protection level is activated. No password is required for activation. A password must be entered to deactivate the protection level. The password for the first level is 123456. This protection level can be used to lock-out internal adjustments.

The command triggers an event and therefore has no \*RST value and no query form.

**Example:** "SYST:PROT1 ON"  
'activates protection level 1. Internal adjustments are only possible after deactivating the lock-out.  
  
"SYST:PROT1 OFF, 123456"  
'deactivates protection level 1. Internal adjustments are enabled again.

*RST value	Resolution	Options	SCPI
-	-		Compliant

**SYSTEM:SERRor?**

This command returns a list of all errors existing at the time when the query is started. This list corresponds to the display on the info page under manual control.

The command is a query command and therefore has no \*RST value.

**Example:** "SYST:SERR?"  
'queries all errors existing in the error queue.

Response:

"-221, 'Settings conflict', 153, 'Input voltage out of range'"

'the two returned errors have occurred since the error queue was last queried.

*RST value	Resolution	Options	SCPI
-	-		Device-specific

**SYSTEM:TIME 0...23,0...59,0...59**

The command sets the time for the instrument-internal clock.

**Example:** "SYST:TIME 12,0,0"  
'sets the time to precisely 12 pm.

*RST value	Resolution	Options	SCPI
-	-		Compliant

**SYSTEM:VERSion?**

The command queries the SCPI version with which the instrument complies.

The command is a query command and therefore has no \*RST value.

**Example:** "SYST:VERS?"  
'queries the SCPI version.

Response: 1996

'the instrument complies with the version from 1996.

*RST value	Resolution	Options	SCPI
-	-		Compliant



## TEST Subsystem

The TEST system contains the commands for performing the routines as well as for direct manipulation of the hardware assemblies (:TEST:DIReCt). The self tests return a "0" if the test is performed successfully, otherwise a value other than "0" is returned. None of the commands of this system have an \*RST value.

In the case of two-path instruments, the numerical suffix under TEST distinguishes between RF Path A and RF Path B:

TEST[1] = RF Path A

TEST2 = RF Path B



### Caution!

*The respective hardware assembly responds directly to the :TEST:DIReCt command; any safety mechanisms are bypassed. The command is used for servicing purposes and should not be applied by the user. Improper use could destroy the assembly.*

Command	Parameters	Default unit	Remark
TEST:CONNeCtor:AUXio	-		Query only
TEST:CONNeCtor:BNC	-		Query only
TEST<1 2>:DIReCt	'SSYN'   'IQOP3'   'IQOP6'   'SATT3'   'SATT6'   'DIRECTLAST', subaddress, hex data string		

### TEST:CONNeCtor:AUXio?

The command triggers a test of the AUX IQ interface (see Service Manual Instrument, chapter 1, "Performance Test"). This function is only available via remote control.

**Example:** "TEST:CONN:AUX?"

*RST value	Resolution	Options	SCPI
-	-	Z5	Device-specific

### TEST:CONNeCtor:BNC?

The command triggers a test of the BNC connectors of the instrument (see Service Manual Instrument, chapter 1, "Performance Test"). This function is only available via remote control.

**Example:** "TEST:CONN:BNC?"

*RST value	Resolution	Options	SCPI
-	-	Z5	Device-specific

**TEST<1|2>:DIRect** "SSYN' | 'IQOP3' | 'IQOP6' | 'SATT3' | 'SATT6' | 'DIRECTLAST', subaddress, hex data string

The respective hardware assembly responds directly to the command; any safety mechanisms are bypassed. This function is only available via remote control.

**Example:** "TEST:DIR 'SSYN',0,#H12345678"  
 "TEST:DIR? 'SSYN',0"

Response:  
 '#H12345678

*RST value	Resolution	Options	SCPI
-	-	SOURce2 only with option B20x	Device-specific

## TRIGger Subsystem

The TRIGger system contains the commands for selecting the trigger source for the RF and LF sweep.

The trigger input connectors are configured in the SOURce:INPut subsystem.

In the case of two-path instruments, the suffix determines the path for which the trigger setting is effective:

Path A = TRIGger[1]

Path B = TRIGger2

In addition, the LF output is activated with TRIGger0.

The trigger system of the R&S Vector Signal Generator is a simplified implementation of the SCPI trigger system. The TRIGger system differs from the SCPI system as follows:

- No INITiate command; the instrument behaves as if INITiate:CONTinuous ON were set.
- Under TRIGger several sweep subsystems exist.

Other commands associated with the trigger system of the R&S Vector Signal Generator can be found in the modulation and RF signal subsystems.

Command	Parameters	Default unit	Remark
TRIGger0[:SWEep]:SOURce	AUTO   IMMEDIATE   SINGLE   BUS   EXTERNAL		
TRIGger<[1] 2>:FSWEEP[:IMMEDIATE]			No query
TRIGger<[1] 2>:FSWEEP:SOURce	AUTO   IMMEDIATE   SINGLE   BUS   EXTERNAL		
TRIGger<[1] 2>:LIST[:IMMEDIATE]			No query
TRIGger<[1] 2>:PSWEEP[:IMMEDIATE]			No query
TRIGger<[1] 2>:PSWEEP:SOURce	AUTO   IMMEDIATE   SINGLE   BUS   EXTERNAL		
TRIGger<[1] 2>[:SWEep][:IMMEDIATE]			No query
TRIGger<[1] 2>[:SWEep]:SOURce	AUTO   IMMEDIATE   SINGLE   BUS   EXTERNAL		

**TRIGger0[:SWEep]:SOURce** AUTO | IMMEDIATE | SINGLE | EXTERNAL|BUS

The command sets the trigger source for the LF sweep. The trigger is triggered by the command :SOURce:LFOutput:SWEep[:FREQuency]EXECute.

The names of the parameters correspond directly to the various settings under manual control. SCPI uses other names for the parameters; these names are also accepted by the instrument. The SCPI names should be used if compatibility is an important consideration. An overview of the various names is given in the following table:

R&S name	SCPI name	Command under manual control
AUTO	IMMEDIATE	<b>Auto</b> mode
SINGLE	BUS	<b>Single</b> and <b>Step</b> mode. The command LFO:SWEep:MODE is used to select between the two sweep modes.
EXTERNAL	EXTERNAL	<b>Ext Single</b> and <b>Ext Step</b> mode. The command LFO:SWEep:MODE is used to select between the two sweep modes.

**Parameters:** AUTO | IMMEDIATE

The trigger is free-running, i.e. the trigger condition is fulfilled continuously. As soon as one sweep is finished, the next sweep is started.

**SINGLE**

The sweep is triggered by the IEC/IEEE-bus commands ::LFOutput:SWEep:EXEC or \*TRG. If :SOURce:SWEep:MODE is set to STEP, one step is executed. If :SOURce:SWEep:MODE is set to AUTO, one complete sweep is executed.

**EXTERNAL**

The sweep is triggered externally via the INST TRIG connector (Path A = BNC connector; Path B = Pin at AUX I/O interface).

**Example:** "TRIG0:SOUR EXT"

'selects triggering with an external trigger. The trigger is input via the INST TRIG connector.

*RST value	Resolution	Options	SCPI
SINGLE	-	-	Device-specific

**TRIGger<[1]|2>:FSWEEP[:IMMEDIATE]**

The command immediately starts an RF frequency sweep. The sweep to be executed depends on the respective MODE setting (SOURce:SWEep:FREQuency:MODE SING). The command corresponds to the manual-control command **Execute Trigger**.

This command triggers an event and therefore has no \*RST value.

**Example:** "SWE:FREQ:MODE SING"

'sets the Single trigger mode, i.e. a trigger starts a single sweep.

"TRIG:FSW"

'starts a single RF frequency sweep for Path A.

*RST value	Resolution	Options	SCPI
-	-	SOURce2 only with option B20x	Device-specific

**TRIGger<[1]|2>:FSWEEP:SOURce AUTO|IMMEDIATE | SINGLE | EXTERNAL|BUS**

The command sets the trigger source for the RF frequency sweep.

The names of the parameters correspond directly to the various settings under manual control. SCPI uses other names for the parameters; these names are also accepted by the instrument. The SCPI names should be used if compatibility is an important consideration. An overview of the various names is given in the following table:

R&S name	SCPI name	Command under manual control
AUTO	IMMEDIATE	<b>Auto</b> mode
SINGLE	BUS	<b>Single</b> and <b>Step</b> mode. The command :SWEep:FREQ:MODE is used to select between the two sweep modes.
EXTERNAL	EXTERNAL	<b>Ext Single</b> and <b>Ext Step</b> mode. The command :SWEep:FREQ:MODE is used to select between the two sweep modes.

**Parameters: AUTO | IMMEDIATE**

The trigger is free-running, i.e. the trigger condition is fulfilled continuously. As soon as one sweep is finished, the next sweep is started.

**SINGLE**

The sweep is triggered by the IEC/IEEE-bus commands ...:SWEep:EXEC or \*TRG or TRIG:FSW:IMM. If :SOURce:SWEep:MODE is set to STEP, one step is executed. If :SOURce:SWEep:MODE is set to AUTO, one complete sweep is executed.

**EXTERNAL**

The sweep is triggered externally via the INST TRIG connector (Path A = BNC connector; Path B = Pin at AUX I/O interface).

**Example:** "TRIG:FSW:SOUR EXT"

'selects triggering with an external trigger. The trigger is input via the TRIGGER 1 connector.

*RST value	Resolution	Options	SCPI
SINGLE	-	SOURce2 only with option B20x	Device-specific

**TRIGger<[1]|2>:LIST[:IMMEDIATE]**

The command immediately starts the processing of a list in LIST mode. It corresponds to the manual-control command **Execute Trigger**.

This command triggers an event and therefore has no \*RST value.

**Example:**

"SOUR2:LIST "LIST1"  
'selects the list for Path B.  
"SOUR2:LIST:DWEL 5 ms"  
'sets the dwell time to 5 ms.  
  
"TRIG2:LIST"  
'starts processing of the selected list in Path B.

*RST value	Resolution	Options	SCPI
-	-	SOURce2 only with option B20x	Device-specific

**TRIGger<[1]|2>[:PSweep][:IMMediate]**

The command immediately starts an RF level sweep. The sweep to be executed depends on the set sweep mode (:SOURce:SWEep:POWer:MODE). The command corresponds to the manual-control command **Execute Trigger**.

This command triggers an event and therefore has no \*RST value.

**Example:** "SWE:POW:MODE STEP"  
 'sets the STEP trigger mode, i.e. a trigger starts the sweep initially, and then the sweep is generated continuously.  
 "TRIG:PSW"  
 'starts the continuous generation of the RF level sweep at output A.

*RST value	Resolution	Options	SCPI
-	-	SOURce2 only with option B20x	Device-specific

**TRIGger<[1]|2>:PSweep:SOURce AUTO|IMMediate | SINGle | EXTernal|BUS**

The command sets the trigger source for the RF level sweep.

The names of the parameters correspond directly to the various settings under manual control. SCPI uses other names for the parameters; these names are also accepted by the instrument. The SCPI names should be used if compatibility is an important consideration. An overview of the various names is given in the following table:

R&S name	SCPI name	Command under manual control
AUTO	IMMediate	<b>Auto</b> mode
SINGle	BUS	<b>Single</b> and <b>Step</b> mode. The command :SWEep:POW:MODE is used to select between the two sweep modes.
EXTernal	EXTernal	<b>Ext Single</b> and <b>Ext Step</b> mode. The command :SWEep:POW:MODE is used to select between the two sweep modes.

**Parameters:** **AUTO | IMMediate**  
 The trigger is free-running, i.e. the trigger condition is fulfilled continuously. As soon as one sweep is finished, the next sweep is started.

**SINGle**  
 The sweep is triggered by the IEC/IEEE-bus commands :SOURce:SWEep:POWer:EXEC or \*TRG or TRIGger:PSweep:IMMediate. If :SOURce:SWEep:POWer:MODE is set to STEP, one step is executed. If :SOURce:SWEep:POWer:MODE is set to AUTO, one complete sweep is executed.

**EXTernal**

**Example:** "TRIG:PSW:SOUR EXT"  
 'selects triggering with an external trigger. The trigger is input via the INST TRIG connector.

*RST value	Resolution	Options	SCPI
SINGle	-	SOURce2 only with option B20x	Device-specific

**TRIGger<[1]|2>[:SWEep][:IMMediate]**

The command starts all sweeps which are activated for the respective path. The sweep to be executed depends on the respective MODE setting (: SOUR< [ 1 ] | 2> : SWEep : POW | FREQ : MODE and : SOUR< [ 1 ] | 2> : LFO : SWEep [ : FREQ ] : MODE).

The command corresponds to the manual-control command **Execute Trigger**.

This command triggers an event and therefore has no \*RST value.

**Example:** "TRIG"  
'starts all active sweeps in Path A.

*RST value	Resolution	Options	SCPI
-	-	SOURce2 only with option B20x	Device-specific

**TRIGger<[1]|2>:SWEep:SOURce AUTO|IMMediate | SINGle | EXTernal|BUS**

The command sets the trigger source for all sweeps.

The names of the parameters correspond directly to the various settings under manual control. SCPI uses other names for the parameters; these names are also accepted by the instrument. The SCPI names should be used if compatibility is an important consideration.

An overview of the various names is given in the following table:

R&S name	SCPI name	Command under manual control
AUTO	IMMediate	MODE AUTO
SINGle	BUS	MODE SINGLE or STEP
EXTernal	EXTernal	MODE EXT TRIG SINGLE or EXT TRIG STEP

**Parameters: AUTO | IMMediate**

The trigger is free-running, i.e. the trigger condition is fulfilled continuously. As soon as one sweep is finished, the next sweep is started.

**SINGle**

The sweep is triggered by the IEC/IEEE-bus commands

: SOURce : SWEep : POWer | FREQuency : EXEC or \*TRG or

TRIGger : PSWEEP | FSWEEP : IMMediate. If : SOURce : SWEep : POWer : MODE

is set to STEP, one step is executed. If : SOURce : SWEep : POWer : MODE is set to AUTO, one complete sweep is executed.

**EXTernal**

The sweep is triggered externally via the TRIGGER connectors.

**Example:** "TRIG:SWE:SOUR EXT"  
'selects triggering with an external trigger. The trigger is input via the TRIGGER 1 connector.

*RST value	Resolution	Options	SCPI
SINGle	-	SOURce2 only with option B20x	Device-specific

# UNIT Subsystem

The UNIT subsystem contains the commands specifying which units are valid if no unit is indicated in a command. These settings are valid for the entire instrument.

Command	Parameters	Default unit	Remark
UNIT:ANGLE	DEG   RAD		
UNIT:POW	V   DBM		

## UNIT:ANGLE DEG | RAD

The command defines the default unit for angles. It is valid for all commands which determine angle values. It does not influence the manual control parameter unit and the display.

**Example:** "UNIT:ANGL DEG"  
 'sets default unit DEG for all commands which determine angle values.

*RST value	Resolution	Options	SCPI
RAD	-		Compliant

## UNIT:POW V | DBM

The command defines the default unit for power. It is valid for all commands which determine power values. It does not influence the manual control parameter unit and the display.

**Example:** "UNIT:POW V"  
 'sets default unit V for all commands which determine power values.

*RST value	Resolution	Options	SCPI
DBM	-		Compliant

## Alphabetical List of R&S SMIQ Commands

The table lists the commands of the R&S SMIQ in the **SMIQ Command** column and describes their function in the **Short description** column. A checkmark in the **SMATE** column indicates that the command is also implemented in the R&S SMATE. Differences between the two sets of commands are specified in the **Remarks** column.

SMIQ Command	Short description	SMATE	Remarks
ABORT:...	Reset		
ABORT[:SWEep]	Reset sweep	√	
ABORT:LIST	Reset list mode	√	
ARB:...	Arbitrary Waveform Generator		SMATE: [SOURce<[1]]2>.:BB:ARB:...
ARBASET:...	Automatic settings on/off	-	
ARB:CLOCK	Clock rate	√	
ARB:CLOCK:DELay	Clock delay	-	
ARB:CLOCK:SOURce	Clock source	√	
ARB:IQ:...	IQ settings	-	
ARB:SEQuence	Trigger mode	√	
ARB:STATe	ARB generator on/off	√	
ARB:TRIGger:DELay	Trigger delay	√	
ARB:TRIGger:INHibit	Trigger inhibition	√	
ARB:TRIGger:OUTPut<[1]]2>:DELay	Marker delay	√	
ARB:TRIGger:OUTPut<[1]]2>:MODE	Marker signal	√	
ARB:TRIGger:OUTPut<[1]]2>:MODE:CATalog	Marker files	-	
ARB:TRIGger:OUTPut<[1]]2>:OFFTime	OFF period for TRIGger:OUTPut:MODE USER	√	SMATE: OFF period for TRIGger:OUTPut:MODE RATio
ARB:TRIGger:OUTPut<[1]]2>:ONTime	ON period for TRIGger:OUTPut:MODE USER	√	SMATE: ON period for TRIGger:OUTPut:MODE RATio
ARB:TRIGger:OUTPut<[1]]2>:POLarity	Polarity of marker signal	-	
ARB:TRIGger:SOURce	Trigger source	√	
ARB:WAVeform:CATalog?	Waveform files	√	
ARB:WAVeform:CATalog:LENGth?	Number of waveform files	√	
ARB:WAVeform:DATA	Waveform data	√	
ARB:WAVeform:DELete	Delete waveform	√	
ARB:WAVeform:FREE?	Free memory	-	
ARB:WAVeform:POINts?	Waveform length	√	
ARB:WAVeform:SElect	Select waveform file	√	
ARB:WAVeform:TAG?	Tag contents	√	
CALibration:...	Adjustment of instrument functions	-	SMATE: New functions
CALibration:ALL?	Overall adjustment	√	
DIAGnostic:...	Calculate checksum of control list	-	SMATE: New functions
DISPlay:...	Display Configuration	-	
FORMat:...	Data format		
FORMat:BORDer	Sequence of bytes within a binary block	√	
FORMat[:DATA]	Data format	√	



SMIQ Command	Short description	SMA TE	Remarks
MEMory:...	Memory configuration	-	SMATE: New functions
OUTPut[1]:...	RF output settings	√	SMATE: OUTPut<[1]>2>, OUTPut1 = path A OUTPut2 = path B
OUTPut[1]:AFIXed:RANGe:LOWer?	Minimum level	√	
OUTPut[1]:AFIXed:RANGe:UPPer?	Maximum level	√	
OUTPut[1]:AMode	Attenuator mode	√	
OUTPut[1]:BLANk:POLarity?	Polarity of the No Signal (Blank) marker	√	
OUTPut[1]:IMPedance	Impedance of RF-output	-	
OUTPut[1]:PROTection:CLear	Resets protective circuit	√	
OUTPut[1]:PROTection:TRIPped?	State of the protective circuit	√	
OUTPut[1]::STATe]	RF output on/off	√	
OUTPut[1]::STATe];PON	State of RF-output after switch-on	√	
OUTPut2:...	LF output settings		SMATE: LF output = SOURce<[1]>2>:LFOutput:...
OUTPut2:VOLTage	Output voltage of the LF output	√	
OUTPut2[:STATe]	LF output on/off	√	
[SOURce[1]:]AM:...	Amplitude Modulation		SMATE: [SOURce<[1]>2>:]....
[SOURce[1]:]AM:BBANd[:STATe]	BB-AM on/off	√	
[SOURce[1]:]AM[:DEPTh]	Modulation depth AM	√	
[SOURce[1]:]AM:EXTernal:COUPling	Coupling mode EXT MOD (AM) input	√	
[SOURce[1]:]AM:INTernal:FREQUency	AM modulation frequency	√	
[SOURce[1]:]AM:SOURce	AM modulation source	√	
[SOURce[1]:]AM:STATe	AM on/off	√	
[SOURce[1]:]CORRection:....	User Correction		SMATE: [SOURce<[1]>2>:]....
[SOURce[1]:]CORRection:CSET:CATalog?	List of user correction tables	√	
[SOURce[1]:]CORRection:CSET:DATA:FREQUency	Frequency data	√	
[SOURce[1]:]CORRection:CSET:DATA:POWer	Level data	√	
[SOURce[1]:]CORRection:CSET:DELeTe	Deletes the specified table	√	
[SOURce[1]:]CORRection:CSET[:SELeCt]	Table for user correction	√	
[SOURce[1]:]CORRection[:STATe]	Level correction	√	
[SOURce[1]:]DM:....	Custom Dig Mod		SMATE: [SOURce<[1]>2>:]BB:DM:...
[SOURce[1]:]DM:ASK:DEPTh	ASK depth	√	
[SOURce[1]:]DM:CLISt:CATalog?	Query control list catalog	√	
[SOURce[1]:]DM:CLISt:CONTRol[:STATe]	Enable control list	-	
[SOURce[1]:]DM:CLISt:COPIY	Copy control list	√	
[SOURce[1]:]DM:CLISt:DATA	Control list data	√	
[SOURce[1]:]DM:CLISt:DELeTe	Delete Control list	√	
[SOURce[1]:]DM:CLISt:FREe?	Free space for control data	√	
[SOURce[1]:]DM:CLISt:POINtS?	Query length of control list	√	
[SOURce[1]:]DM:CLISt:SELeCt	Select control list	√	
[SOURce[1]:]DM:CLOCK:DELay	Clock delay	-	
[SOURce[1]:]DM:CLOCK:MODE	Clock mode	√	
[SOURce[1]:]DM:CLOCK:POLarity	Clock Polarity	-	
[SOURce[1]:]DM:CLOCK:SOURce	Clock source	√	
[SOURce[1]:]DM:CODing	Coding	√	

SMIQ Command	Short description	SMA TE	Remarks
[SOURCE[1]:]DM:DLIST:CATalog?	Queries data list catalog	√	
[SOURCE[1]:]DM:DLIST:COpy	Copy data list	√	
[SOURCE[1]:]DM:DLIST:DATA	Fill data into data list	√	
[SOURCE[1]:]DM:DLIST:DATA:APPend	Append data in data list	√	
[SOURCE[1]:]DM:DLIST:DATA?	Read out data of data list	√	
[SOURCE[1]:]DM:DLIST:DELeTe	Delete Data list	√	
[SOURCE[1]:]DM:DLIST:FREE?	Free space for data	√	
[SOURCE[1]:]DM:DLIST:POINTs?	Query length of data list	√	
[SOURCE[1]:]DM:DLIST:SELeCt	Select data list	√	
[SOURCE[1]:]DM:FiLTeR:MODE	Filter mode	-	
[SOURCE[1]:]DM:FiLTeR:PARaMeteR	Filter parameter	-	
[SOURCE[1]:]DM:FiLTeR:TYPe	Filter type	√	
[SOURCE[1]:]DM:FLISt:...	Filter lists	-	
[SOURCE[1]:]DM:FORMat	Modulation type	√	
[SOURCE[1]:]DM:FSK:DEVIation	Frequency deviation	√	
[SOURCE[1]:]DM:INPut:IMPedance	Impedance of all data and clock inputs	√	
[SOURCE[1]:]DM:LDIStortion:STATe	Low distortion on/off	-	
[SOURCE[1]:]DM:MDELaY?	Modulation delay for external modulation	√	
[SOURCE[1]:]DM:MLISt:...	Mapping lists	-	
[SOURCE[1]:]DM:PATTeRn	Data pattern	√	
[SOURCE[1]:]DM:PRAMp:ATTenuation	Level attenuation	√	
[SOURCE[1]:]DM:PRAMp:DELaY	Position of ramp envelope	-	
[SOURCE[1]:]DM:PRAMp:SHAPE	Edge shape	√	
[SOURCE[1]:]DM:PRAMp:SOURce	Source for the power ramp control signals	√	
[SOURCE[1]:]DM:PRAMp:TIME	Power ramping rise time and fall time	√	
[SOURCE[1]:]DM:PRAMp:STATe	Power ramping on/off	√	
[SOURCE[1]:]DM:PRBS:LENGTh	PRBS length	√	
[SOURCE[1]:]DM:SEQUence	Trigger mode	√	
[SOURCE[1]:]DM:SOURce	Data source	√	
[SOURCE[1]:]DM:SRATe	Symbol rate	√	
[SOURCE[1]:]DM:STANdard	Standard	√	
[SOURCE[1]:]DM:STATe	Digital modulation on/off	√	
[SOURCE[1]:]DM:THReshold[ALL]	High/low threshold of digital inputs	√	
[SOURCE[1]:]DM:TRIGger:DELaY	Trigger delay	√	
[SOURCE[1]:]DM:TRIGger:INHibit	Trigger inhibition	√	
[SOURCE[1]:]DM:TRIGger:SLOPe	Trigger slope	√	
[SOURCE[1]:]DM:TRIGger:SOURce	Trigger source	√	
[SOURCE[1]:]DM:IQ:---	I/Q modulation	-	SMATE: SOURCE<[1]>:IQ:...
[SOURCE[1]:]DM:IQ:CREStfactor	Crest-Factor	√	
[SOURCE[1]:]DM:IQ:FiLTeR:FREQUency	Select I/Q filter	-	
[SOURCE[1]:]DM:IQ:FiLTeR:STATe	IQ-Filter on/off	-	
[SOURCE[1]:]DM:IQ:IMPairment[STATe]	IQ impairment on/off	√	
[SOURCE[1]:]DM:IQ:LEAKage[MAGNitude]	Leakage amplitude for the Q-channel	√	
[SOURCE[1]:]DM:IQ:QUADrature:ANGLE	Quadrature offset	√	
[SOURCE[1]:]DM:IQ:PRAMp	Power ramping state	-	
[SOURCE[1]:]DM:IQ:STATe	I/Q-modulation on/off	√	
[SOURCE[1]:]DM:IQ:TRANSition	IQ filter transition time	-	
[SOURCE[1]:]DM:IQRatio[MAGNitude]	Imbalance	√	

SMIQ Command	Short description	SMA TE	Remarks
[SOURce[1]:]DM:IQSWap[:]STATe]	Swaps the I and Q channels	√	
[SOURce[1]:]FM:....			
[SOURce[1]:]FM[:]DEVIation]	FM deviation	√	
[SOURce[1]:]FM:EXTernal1 2:COUPling]	Coupling of external mod. input	√	
[SOURce[1]:]FM:INTernal:FREQUency]	Modulation frequency	√	
[SOURce[1]:]FM:PREEmphasis]	Preemphasis	-	
[SOURce[1]:]FM:SOURce]	Modulation source	√	
[SOURce[1]:]FM:STATe]	State	√	
[SOURce[1]:]FREQUency:....			SMATE: SOURce<[1] 2>
[SOURce[1]:]FREQUency:CENTer]	RF-sweep center frequency	√	
[SOURce[1]:]FREQUency[:]CW FIXed]	RF frequency	√	
[SOURce[1]:]FREQUency[:]CW[:]FIXed[:]RCL]	Recall RF frequency	√	
[SOURce[1]:]FREQUency:MANual]	Frequency for the next sweep step	√	
[SOURce[1]:]FREQUency:MODE]	RF operating mode	√	
[SOURce[1]:]FREQUency:OFFSet]	RF-frequency offset	√	
[SOURce[1]:]FREQUency:SPAN]	Span for the sweep	√	
[SOURce[1]:]FREQUency:STARt]	Start frequency for the sweep mode	√	
[SOURce[1]:]FREQUency:STEP[:]INCRement]	Step width for the frequency setting	√	
[SOURce[1]:]FREQUency:STOP]	Stop frequency for the sweep mode	√	
SOURce2:....	LF generator frequency		SMATE: SOURce:LFOutput:FREQUency
SOURce2:FREQUency:MODE]	LF operating mode	√	
SOURce2:FREQUency:STARt]	Start frequency for the LF Sweep	√	
SOURce2:FREQUency:STOP]	Stop frequency for the LF sweep	√	
SOURce2:FREQUency[:]CW FIXed]	Frequency LF signal	√	
[SOURce[1]:]GSM:...	Standard GSM		SMATE: SOURce<[1] 2>:BB:GSM...
[SOURce[1]:]GSM:CLOCK:DELay]	Clock delay	-	
[SOURce[1]:]GSM:CLOCK:SOURce]	Clock source	√	
[SOURce[1]:]GSM:DLISt:...	Data lists	-	SMATE: SOURce:BB:DM:DLISt...
[SOURce[1]:]GSM:FILTer:TYPE]	Filter type	√	
[SOURce[1]:]GSM:FILTer:PARAmeter]	Filter parameter	√	
[SOURce[1]:]GSM:FLISt:...	Filter lists	-	
[SOURce[1]:]GSM:FORMat]	Modulation type	√	
[SOURce[1]:]GSM:FSK:DEVIation]	FSK modulation deviation	√	
[SOURce[1]:]GSM:PRAMP:DELay]	Ramp envelope offset	√	
[SOURce[1]:]GSM:PRAMP:FOFFset]	Offset in the falling edge	√	
[SOURce[1]:]GSM:PRAMP:PRESet]	Preset PRAMP	-	
[SOURce[1]:]GSM:PRAMP:ROFFset]	Offset in the rising edge	√	
[SOURce[1]:]GSM:PRAMP:SHAPE]	Edge shape	√	
[SOURce[1]:]GSM:PRAMP:TIME]	Edge slope	√	
[SOURce[1]:]GSM:SEQUence]	Trigger mode	√	
[SOURce[1]:]GSM:SLOT:ATTenuation]	Level attenuation	-	
[SOURce[1]:]GSM:SLOT<0 [1]...7>:LEVel]	Power control level	√	
[SOURce[1]:]GSM:SLOT<0 [1]...7>:SF]	Stealing Flag	√	
[SOURce[1]:]GSM:SLOT<0 [1]...7>:TSC:SElect]	Training sequence	√	
[SOURce[1]:]GSM:SLOT<0 [1]...7>:TSC:USER]	Training's sequence	√	

SMIQ Command	Short description	SMA TE	Remarks
[SOURce[1]:]GSM:SLOT<0[[1]...7>:TYPE	Burst type	√	
[SOURce[1]:]GSM:SLOT<0[[1]...7>[:SOURce]:DATA	Data source	√	
[SOURce[1]:]GSM:SLOT<0[[1]...7>[:SOURce]:DATA:DLIST	Selection of data list	√	
[SOURce[1]:]GSM:SLOT<n>:HOPping:TRIGger	Trigger for hopping (LIST Mode)	-	
[SOURce[1]:]GSM:SLOT<n>:PRESet	Preset slot	-	
[SOURce[1]:]GSM:SRATe	Symbol clock	√	
[SOURce[1]:]GSM:STANdard	Preset	-	
[SOURce[1]:]GSM:STATe	GSM on/off	√	
[SOURce[1]:]GSM:TRIGger:DELay	Trigger delay	√	
[SOURce[1]:]GSM:TRIGger:INHibit	Trigger inhibit	√	
[SOURce[1]:]GSM:TRIGger:OUTPut<[1]]2>	Trigger signal	-	
[SOURce[1]:]GSM:TRIGger:OUTPut<[1]]2>:DELay	Marker delay	√	
[SOURce[1]:]GSM:TRIGger:OUTPut<[1]]2>:PERiod	Frame marker period	√	
[SOURce[1]:]GSM:TRIGger:OUTPut<[1]]2>:POLarity	Polarity of marker output	-	
[SOURce[1]:]GSM:TRIGger:SOURce	Trigger source	√	
[:SOURce]:LIST:...	List mode		SMATE: SOURce<[1]]2>:LIST:....
[:SOURce]:LIST:CATalog?	Queries available lists	√	
[:SOURce]:LIST:DELete	Deletes the specified list	√	
[:SOURce]:LIST:DELete:ALL	Deletes all lists	√	'
[:SOURce]:LIST:DWELI	Dwell time	√	
[:SOURce]:LIST:FREE?	Free memory	√	
[:SOURce]:LIST:FREQUency	Input of frequency values	√	
[:SOURce]:LIST:FREQUency:POINTs?	Number of frequency values	√	
[:SOURce]:LIST:LEARn	Learns the current list	√	
[:SOURce]:LIST:MODE	List-operating mode	√	
[:SOURce]:LIST:POWer	Level values for list	√	
[:SOURce]:LIST:POWer:POINTs?	Length of the LEVel part	√	
[:SOURce]:LIST:SELect	Selects the specified list.	√	
[:SOURce]:MARKer:...	Marker settings for sweeps	-	
[SOURce[1]:]MODulation:...	Modulation state	-	
[SOURce[1]:]NOISe:...	Noise settings	-	SMATE: SOURce<[1]]2>:AWGN
[:SOURce]:NOISe:BANDwidth BWIDth	Noise bandwidth	√	
[:SOURce]:NOISe:SNRatio	Signal/noise ratio	√	
[:SOURce]:NOISe[:STATe]	Activates noise generator	√	'
[SOURce[1]:]PHASe:...	Phase settings		SMATE: SOURce<[1]]2>:PHASe:....
[SOURce[1]:]PHASe:REFerence	Sets the phase	√	
[SOURce[1]:]PHASe[:ADJust]	Phase variation relative to the current phase	√	
[SOURce[1]:]PM:....			
[SOURce[1]:]PM[:DEViation]	PM deviation	√	
[SOURce[1]:]PM:EXTernal1 2:COUPLing	Coupling of external mod. input	√	
[SOURce[1]:]PM:INTernal:FREQUency	Modulation frequency	√	
[SOURce[1]:]PM:SOURce	Modulation source	√	
[SOURce[1]:]PM:STATe	State	√	
[SOURce[1]:]POWer:...	Level settings		SMATE: SOURce<[1]]2>:POWer:....
[SOURce[1]:]POWer:ALC:SEARCh	Level control mode	-	

SMIQ Command	Short description	SMA TE	Remarks
[SOURce[1]:]POWer:ALC:TABLE[:MEASure]?	Correction values for level table	-	
[SOURce[1]:]POWer:ALC[:STATE]	Automatic level control on/off	√	
[SOURce[1]:]POWer:LIMit[:AMPLitude]	Level limit	√	
[SOURce[1]:]POWer:MANual	Level for the next sweep step	√	
[SOURce[1]:]POWer:MODE	Operating mode	√	
[SOURce[1]:]POWer:PEP?	Queries PEP	√	
[SOURce[1]:]POWer:START	RF start level	√	
[SOURce[1]:]POWer:STEP[:INCRement]	Step width for the level setting	√	
[SOURce[1]:]POWer:STOP	Stop level	√	
[SOURce[1]:]POWer[:LEVel][:IMMediate]:OFFSet	Level offset	√	
[SOURce[1]:]POWer[:LEVel][:IMMediate][:AMPLitude]	RF output level	√	
[SOURce[1]:]POWer[:LEVel][:IMMediate]:RCL	Recall RF level	√	
[SOURce[1]:]PULM:...	Pulse modulation		SMATE: SOURce<[1]2>:PULM:....
[SOURce[1]:]PULM:POLarity	Polarity pulse modulation	√	
[SOURce[1]:]PULM:STATE	Pulse modulation on/off	√	
[SOURce[1]:]ROSCillator:...	Reference frequency	√	
[SOURce[1]:]ROSCillator:EXTernal:FREQuency	Frequency of the external reference	√	
[SOURce[1]:]ROSCillator[:INTerna]:ADJust:VALue	Adjustment value	√	
[SOURce[1]:]ROSCillator[:INTerna]:ADJust[:STATE]	Fine adjustment of the frequency on/off	√	
[SOURce[1]:]ROSCillator:SOURce	Reference frequency source	√	
[SOURce[1]:]SWEep:...	RF sweeps		SMATE: SOURce<[1]2>:SWEep:....
[SOURce[1]:]SWEep:BTIME	Blank time sweep	-	
[SOURce[1]:]SWEep[:FREQuency]:DWELI	Dwell time	√	
[SOURce[1]:]SWEep[:FREQuency]:MODE	Sweep mode	√	
[SOURce[1]:]SWEep[:FREQuency]:POINts	Number of steps in an RF sweep	√	
[SOURce[1]:]SWEep[:FREQuency]:SPACing	Sweep spacing	√	
[SOURce[1]:]SWEep[:FREQuency]:STEP:LOGarithmic	Step width factor for logarithmic sweeps	√	
[SOURce[1]:]SWEep[:FREQuency]:STEP[:LINear]	Step width for linear sweeps	√	
[SOURce[1]:]SWEep:POWer:DWELI	Time for each level step	√	
[SOURce[1]:]SWEep:POWer:MODE	Sweep mode	√	
[SOURce[1]:]SWEep:POWer:POINts	Number of steps in a level sweep	√	
[SOURce[1]:]SWEep:POWer:STEP:LOGarithmic	Step width factor for logarithmic sweeps	√	
:SOURce2:...	LF generator sweep		SMATE: SOURce:LFOutput:SWEep
:SOURce2:SWEep:BTIME	Blank Time	-	
:SOURce2:SWEep[:FREQuency]:DWELI	Dwell time for each frequency step	√	
:SOURce2:SWEep[:FREQuency]:MODE	Sweep mode LF sweep	√	
:SOURce2:SWEep[:FREQuency]:POINts	Number of steps in an LF sweep	√	
:SOURce2:SWEep[:FREQuency]:SPACing	Lin or log LF sweep	√	
:SOURce2:SWEep[:FREQuency]:STEP:LOGarithmic	Step width for the log sweep	√	
:SOURce2:SWEep[:FREQuency]:STEP[:LINear]	Step width for the linear sweep	√	
[:SOURce]:W3GPP:....	3GPP FDD		SMATE: [SOURce<[1]2>]:BB:W3GPP:...
[:SOURce]:W3GPP:BSTation:ENHanced:..	Enhanced base station	-	SMATE: extended functions

SMIQ Command	Short description	SMA TE	Remarks
[[:SOURce]:W3GPP:BSTation<n>:CHANnel<n>:CCODe	Channelization code	√	
[[:SOURce]:W3GPP:BSTation<n>:CHANnel<n>:DATA	Data source	√	
[[:SOURce]:W3GPP:BSTation<n>:CHANnel<n>:DATA: PATTem	Data pattern	√	
[[:SOURce]:W3GPP:BSTation<n>:CHANnel<n>:MCODe	Multicode on/off	-	
[[:SOURce]:W3GPP:BSTation<n>:CHANnel<n>:PLENgth	Length of the pilot fields	-	
[[:SOURce]:W3GPP:BSTation<n>:CHANnel<n>:POWer	Channel power	√	
[[:SOURce]:W3GPP:BSTation<n>:CHANnel<n>:SRATe	Symbol rate	√	
[[:SOURce]:W3GPP:BSTation<n>:CHANnel<n>:STATe	Channel on/off	√	
[[:SOURce]:W3GPP:BSTation<n>:CHANnel<n>:TOFFSet	Timing Offset	√	
[[:SOURce]:W3GPP:BSTation<n>:CHANnel<n>:TPC	TPC data source	-	
[[:SOURce]:W3GPP:BSTation<n>:CHANnel<n>:TPC: PATTem	TPC pattern	-	
[[:SOURce]:W3GPP:BSTation<n>:DOMain:ERRor?	Queries code domain conflicts	-	
[[:SOURce]:W3GPP:BSTation<n>:MCHannel:EXECute?	Multichannel setting on/off	-	
[[:SOURce]:W3GPP:BSTation<n>:PINDicator:COUNT	Number of Page Indicators	√	
[[:SOURce]:W3GPP:BSTation<n>:SCODE	Scrambling code	√	
[[:SOURce]:W3GPP:BSTation<n>:SCODE:STATe	Scrambling on/off	√	
[[:SOURce]:W3GPP:BSTation<n>:SSCG?	Secondary Synchronization Code Group	√	
[[:SOURce]:W3GPP:BSTation<n>:STATe	Base station on/off	√	
[[:SOURce]:W3GPP:BSTation<n>:TFCl	TFCl value	-	
[[:SOURce]:W3GPP:BSTation<n>:TFCl:STATe	TFCl on/off	-	
[[:SOURce]:W3GPP:BSTation<n>:TPC:MISSuse	Misuse TPC	-	
[[:SOURce]:W3GPP:BSTation<n>:TPC:POWer:STEP	Step width for MisUse TPC	-	
[[:SOURce]:W3GPP:BSTation<n>:TPC:READ	Read out mode TPC	-	
[[:SOURce]:W3GPP:BSTation<n>:TRANsmit:DIVersity	Transmit Diversity on/off	-	
[[:SOURce]:W3GPP:CALCulate:PROGress?	Calculation progress	-	
[[:SOURce]:W3GPP:CLIPping:LEVel	Clipping level	√	
[[:SOURce]:W3GPP:CLOCK:DELay	Clock Delay	-	
[[:SOURce]:W3GPP:CLOCK:MODE	Clock type	√	
[[:SOURce]:W3GPP:CLOCK:SOURce	Clock source	√	
[[:SOURce]:W3GPP:COPY:COFFset	Offset Channelization Code for copying	√	
[[:SOURce]:W3GPP:COPY:DESTination	Destination for copy process	√	
[[:SOURce]:W3GPP:COPY:EXECute	Starting the copy process	√	
[[:SOURce]:W3GPP:COPY:SOURce	Source for copy process	√	
[[:SOURce]:W3GPP:CRATE:VARiation	Output chip rate	√	
[[:SOURce]:W3GPP:CRATE?	Queries chip rate	√	
[[:SOURce]:W3GPP:FILTer:MODE	Filter mode	-	
[[:SOURce]:W3GPP:FILTer:PARAmeter	Filter parameter	-	
[[:SOURce]:W3GPP:FILTer:SElect	Selection of User filter	-	
[[:SOURce]:W3GPP:FILTer:TYPE	Filter type	√	
[[:SOURce]:W3GPP:GPP3:VERSion?	3GPP version	√	
[[:SOURce]:W3GPP:LINK	Transmission direction	√	
[[:SOURce]:W3GPP:MCHannel:...	Multi channel settings	-	
[[:SOURce]:W3GPP:MSTation:ADDitional:COUNT	Number of add. UE	√	
[[:SOURce]:W3GPP:MSTation:ADDitional:POWer:OFFSet	Power offset of add. UE	√	
[[:SOURce]:W3GPP:MSTation:ADDitional:SCODE:STEP	Step width for increase of scrambling code	√	

SMIQ Command	Short description	SMA TE	Remarks
[.SOURce]:W3GPp:MSTation:ADditiOnal:STATe	Add. UE on/off	√	
[.SOURce]:W3GPp:MSTation:ENHanced:..		-	SMATE: extended functions
[.SOURce]:W3GPp:MSTation<n>:DPCCh:FBI:DATA	Data source FBI field	-	
[.SOURce]:W3GPp:MSTation<n>:DPCCh:FBI:MODE	Number of bits FBI field	√	
[.SOURce]:W3GPp:MSTation<n>:DPCCh:FBI:PATTer n	FBI Pattern	√	
[.SOURce]:W3GPp:MSTation<n>:DPCCh:POWer	Power DPCCH	√	
[.SOURce]:W3GPp:MSTation<n>:DPCCh:TFCI	Value of TFCI field	√	
[.SOURce]:W3GPp:MSTation<n>:DPCCh:TFCI:STATe	TFCI on/off	√	
[.SOURce]:W3GPp:MSTation<n>:DPCCh:TOFFset?	Queries Timing Offset	√	
[.SOURce]:W3GPp:MSTation<n>:DPCCh:TPC:MISuse	TPC Misuse	√	
[.SOURce]:W3GPp:MSTation<n>:DPCCh:TPC:PSTep	Step width TPC Misuse	√	
[.SOURce]:W3GPp:MSTation<n>:DPDCh<n>:DATA	Data source DPDCH	-	
[.SOURce]:W3GPp:MSTation<n>:DPDCh<n>:ORATe	Overall symbol rate	√	
[.SOURce]:W3GPp:MSTation<n>:DPDCh<n>:POWer	Channel power DPDCH	√	
[.SOURce]:W3GPp:MSTation<n>:DPDCh<n>:TYPE?	Channel Type	-	
[.SOURce]:W3GPp:MSTation<n>:DPDCh<n>:CCODE?	Channelization Code	-	
[.SOURce]:W3GPp:MSTation<n>:DPDCh<n>:PATTer n	Pattern DPDCH	-	
[.SOURce]:W3GPp:MSTation<n>:DPDCh<n>:SRATe?	Queries symbol rate	-	
[.SOURce]:W3GPp:MSTation<n>:MODE	Signal of user equipment	√	
[.SOURce]:W3GPp:MSTation<n>:PCPCh:ASLot	Access Slot	√	
[.SOURce]:W3GPp:MSTation<n>:PCPCh:CPOWer	Power of the control component of the PCPCH	√	
[.SOURce]:W3GPp:MSTation<n>:PCPCh:DATA	Data source PCPCh	√	
[.SOURce]:W3GPp:MSTation<n>:PCPCh:DPOWer	Dower of the data component of the PCPCH	√	
[.SOURce]:W3GPp:MSTation<n>:PCPCh:FBI:DATA	Data source FBI field	-	
[.SOURce]:W3GPp:MSTation<n>:PCPCh:FBI:MODE	FBI mode	√	
[.SOURce]:W3GPp:MSTation<n>:PCPCh:FBI:PATTer n	FBI pattern	√	
[.SOURce]:W3GPp:MSTation<n>:PCPCh:MLENght	Length of the message component	√	
[.SOURce]:W3GPp:MSTation<n>:PCPCh:PATTer n	Pattern DATA part	√	
[.SOURce]:W3GPp:MSTation<n>:PCPCh:PLENght	Length of the power control preamble	√	
[.SOURce]:W3GPp:MSTation<n>:PCPCh:PPOWer	Power of the preamble component	√	
[.SOURce]:W3GPp:MSTation<n>:PCPCh:PPOWer:ST EP	Step width of the power increase	√	
[.SOURce]:W3GPp:MSTation<n>:PCPCh:PREPetition	Number of preamble components	√	
[.SOURce]:W3GPp:MSTation<n>:PCPCh:SIGNature	Signature	√	
[.SOURce]:W3GPp:MSTation<n>:PCPCh:SRATe	Symbol rate PDPCH	√	
[.SOURce]:W3GPp:MSTation<n>:PCPCh:TFCI	TFCI	√	
[.SOURce]:W3GPp:MSTation<n>:PRACH:ASLot	Access slot	√	
[.SOURce]:W3GPp:MSTation<n>:PRACH:CPOWer	Power of the control component of the PRACH	√	
[.SOURce]:W3GPp:MSTation<n>:PRACH:DATA	Data source PRACH	√	
[.SOURce]:W3GPp:MSTation<n>:PRACH:DATA:PATT ern	Pattern DATA-part	√	
[.SOURce]:W3GPp:MSTation<n>:PRACH:DPOWer	Power of the data component of PRACH	√	
[.SOURce]:W3GPp:MSTation<n>:PRACH:MLENght	Length of the message component	√	

SMIQ Command	Short description	SMA TE	Remarks
[SOURce]:W3GPp:MSTation<n>:PRACH:PPOWer	Power of the preamble component	√	
[SOURce]:W3GPp:MSTation<m>:PRACH:PREPetition	Number of PRACH preamble components	√	
[SOURce]:W3GPp:MSTation<n>:PRACH:SIGNature	Signature	√	
[SOURce]:W3GPp:MSTation<n>:PRACH:SRATe	Symbol rate PRACH	√	
[SOURce]:W3GPp:MSTation<n>:PRACH:TFCI	TFCI value PRACH	√	
[SOURce]:W3GPp:MSTation<n>:SCODE	Scrambling Code	√	
[SOURce]:W3GPp:MSTation<n>:SCODE:MODE	Scrambling Code Type	√	
[SOURce]:W3GPp:MSTation<n>:STATe	User equipment on/off	√	
[SOURce]:W3GPp:MSTation<n>:TPC:DATA	Data source TPC field PCPCH	√	
[SOURce]:W3GPp:MSTation<n>:TPC:PATtern	Pattern TPC field PCPCH	-	
[SOURce]:W3GPp:MSTation<n>:TPC:READ	Read out mode TPC PCPCh	-	
[SOURce]:W3GPp:OCNS	OCNS channels on/off	-	
[SOURce]:W3GPp:POWer:ADJust	Adjustment of power	√	
[SOURce]:W3GPp:POWer?	Total Power	√	
[SOURce]:W3GPp:PPARAmeter:...	Predefined parameters	-	
[SOURce]:W3GPp:PRESet	Preset	√	
[SOURce]:W3GPp:SEQuence	Trigger mode	√	
[SOURce]:W3GPp:SETTing:CATalog?	Query predefined settings	√	
[SOURce]:W3GPp:SETTing:DELete	Delete predefined settings	√	
[SOURce]:W3GPp:SETTing:LOAD	Load predefined settings	√	
[SOURce]:W3GPp:SETTing:STORe	Store predefined settings	√	
[SOURce]:W3GPp:SETTing:TMODeL:BST	Loads test model downlink	√	
[SOURce]:W3GPp:SETTing:TMODeL:BST:CATalog?	Test models downlink	√	
[SOURce]:W3GPp:SETTing:TMODeL:MST	Loads test model uplink	√	
[SOURce]:W3GPp:SETTing:TMODeL:MST:CATalog?	Test models uplink	√	
[SOURce]:W3GPp:SLENgth	Sequence length of ARB component	√	
[SOURce]:W3GPp:STATe	3GPP FDD modulation on/off	√	
[SOURce]:W3GPp:TRIGger:DELay	Trigger delay	√	
[SOURce]:W3GPp:TRIGger:INHibit	Trigger inhibition	√	
[SOURce]:W3GPp:TRIGger:OUTPut<[1]2>	Marker signal	-	
[SOURce]:W3GPp:TRIGger:OUTPut<[1]2>:DELay	Marker delay	√	
[SOURce]:W3GPp:TRIGger:OUTPut<[1]2>:POLarity	Polarity of marker	-	
[SOURce]:W3GPp:TRIGger:SOURce	Trigger source	√	
STATus:...	Status register		
STATus:OPERation:...	STATus:OPERation register	√	
STATus:PRESet	Reset status registers	√	
STATus:QUEStionable:....	STATus:QUEStionable register	√	
STATus:QUEue[.NEXT]?	Query oldest entry in error queue	√	
SYSTem:...	General instrument settings		
SYSTem:BEEPer:STATe	Key beeper on/off	√	
SYSTem:COMMunicate:GPIB:LTERminator	Terminator recognition remote control	√	
SYSTem:COMMunicate:GPIB[.SELF]:ADDRESS	GPIB address	√	
SYSTem:COMMunicate:SDAta:BAUD	Baud rate	-	
SYSTem:COMMunicate:SERial:...	Serial interface	-	
SYSTem:ERRor?	Query latest error	-	
SYSTem:KLOCK	Disable the front panel keyboard	√	
SYSTem:PRESet	Instrument reset	√	
SYSTem:PROTect<n>[.STATe]	Protection level	√	



SMIQ Command	Short description	SMA TE	Remarks
SYSTem:SSERror?	Query all errors	√	
SYSTem:VERSIon?	SCPI version	√	
TEST:...	Module test	-	SMATE. Extended functions
TRIGger:...	Trigger		
TRIGger[1]:BERT[:IMMediate]	Trigger for BER	√	
TRIGger[1]:BLER[:IMMediate]	Trigger for BLER	√	
TRIGger[1]:DM[:IMMediate]	Trigger mode for DM and digital standards	√	
TRIGger[1]:DM:SOURce	Trigger source for DM and digital standards	√	
TRIGger[1]:LIST:SOURce	Trigger source list mode	√	
TRIGger[1]:LIST[:IMMediate]	Triggers list mode	√	
TRIGger[1]:SLOPe	Active slope of the trigger signal	√	
TRIGger[1]:SWEep[:SOURce]	Trigger source RF sweeps	√	
TRIGger[1]:SWEep[:IMMediate]	Triggers RFsweep	√	
TRIGger2:SWEep:SOURce	Trigger source LF sweep	√	SMATE: :TRIGger0:SWEep:SOURce
TRIGger2[:SWEep[:IMMediate]	Triggers LF sweep	√	
TRIGger:SLOPe	Active slope of trigger signal	√	
UNIT:...	Select unit	-	
UNIT:ANGLE	Angle units	√	
UNIT:POWer	Power unit	√	



## Contents Chapter 8 - Maintenance and Interfaces

<b>8 Maintenance and Remote Control Interfaces .....</b>	<b>7.1</b>
Introduction - Maintenance and Interfaces .....	8.1
Maintenance .....	8.1
Cleaning the Outside and Storing .....	8.1
Hardware Interfaces .....	8.2
IEC/IEEE Bus Interface .....	8.2
Ethernet Interface .....	8.5
USB Connection (USB and USB IN) .....	8.7
Monitor Connector (MONITOR) .....	8.8



# 8 Maintenance and Remote Control Interfaces

## Introduction - Maintenance and Interfaces

The following chapter contains information on the maintenance of the signal generator and a description of the remote control interfaces.

Please follow the instructions in the service manual when exchanging modules or ordering spares. The order no. for spare parts can be found in the service manual.

The address of our support center and a list of all Rohde & Schwarz service centers can be found at the beginning of the printed manual.

The service manual includes further information particularly on troubleshooting, repair and exchange of modules.

## Maintenance

The instrument does not need a periodic maintenance. What is necessary is essentially the cleaning of the instrument. However, it is recommended to check the rated data from time to time.

## Cleaning the Outside and Storing

The outside of the instrument is suitably cleaned using a soft, line-free dust cloth. Make sure that vents are not obstructed.

**Caution!**

*Never use solvents such as thinners, acetone and similar things, as they may damage the front panel labeling or plastic parts.*

The storage temperature range of the instrument is given in the data sheet. If the instrument is to be stored for a longer period of time, it must be protected against dust.

The original packing should be used, particularly the protective covers at the front and rear, when the instrument is to be transported or dispatched. If the original packing is no longer available, use a sturdy cardboard box of suitable size and carefully wrap the instrument to protect it against mechanical damage.

## Hardware Interfaces

The following section describes the remote-control interfaces of the signal generator and the pin assignment of the monitor connector. The AUX IO interface is described with the associated configuration menu in Chapter 4, section "[User Marker - AUX-IO - Setup-Environment-Global...Settings](#)". All other interfaces are described in Chapter 1, sections "[Legend for Front Panel View](#)" and "[Legend for Rear Panel View](#)". For specifications refer to the data sheet.

### IEC/IEEE Bus Interface

The standard instrument is equipped with an IEC/IEEE bus connector. An IEEE 488 interface connector is located on the rear panel. An external controller for remote control of the instrument can be connected via the IEEE 488 interface connector using a shielded cable.

#### Interface Characteristics

- 8-bit parallel data transfer
- bi-directional data transfer
- three-line handshake
- high data transfer rate
- up to 15 instruments can be connected
- maximal length of the interconnecting cables 15 m (single connection, 2m)
- wired-OR connection if several instruments are connected in parallel.

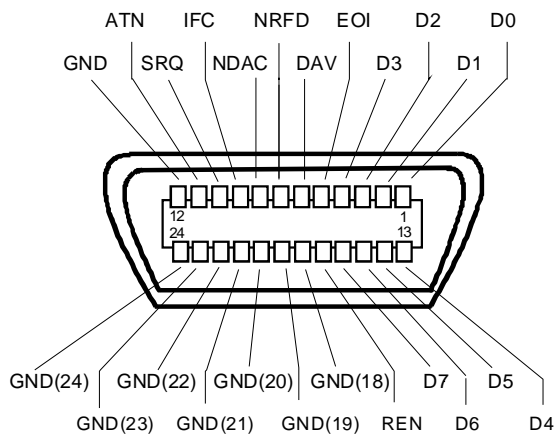

Figure 8-1 Pin assignment of IEC/IEEE-Bus interface

#### Bus Lines

##### 1. Data bus with 8 lines D0 to D7.

The transmission is bit-parallel and byte-serial in the ASCII/ISO code. D0 is the least significant bit, D7 the most significant bit.

##### 2. Control bus with 5 lines

<b>IFC</b> (Interface Clear)	active LOW resets the interfaces of the instruments connected to the default setting.
------------------------------	---

<b>ATN</b> (Attention)	active LOW signals the transmission of interface messages. inactive HIGH signals the transmission of device messages.
<b>SRQ</b> (Service Request)	active LOW enables the connected device to send a service request to the controller.
<b>REN</b> (Remote Enable)	active LOW permits switchover to remote control.
<b>EOI</b> (End or Identify)	has two functions in connection with ATN: ATN = HIGH active LOW marks the end of data transmission. ATN = LOW active LOW triggers a parallel poll.

### 3. Handshake bus with three lines

<b>DAV</b> (Data Valid)	active LOW signals a valid data byte on the data bus.
<b>NRFD</b> (Not Ready For Data)	active LOW signals that one of the connected devices is not ready for data transfer.
<b>NDAC</b> (Not Data Accepted)	active LOW signals that the instrument connected is accepting the data on the data bus.

## IEC/IEEE-Bus Interface Functions

Instruments which can be remote controlled via the IEC/IEEE bus can be equipped with different interface functions. The following table lists the interface functions appropriate for the instrument.

Table 8-1 IEC/IEEE Bus Interface functions

Control character	Interface function
SH1	Handshake source function (source handshake), full capability
AH1	Handshake sink function (acceptor handshake), full capability
L4	Listener function, full capability, unaddress if MTA.
T6	Talker function, full capability, ability to respond to serial poll, unaddress if MLA
SR1	Service request function (Service Request), full capability
PP1	Parallel poll function, full capability
RL1	Remote/Local switch over function, full capability
DC1	Reset function (Device Clear), full capability
DT1	Trigger function (Device Trigger), full capability
C0	No controller function

## IEC/IEEE Bus Messages

Interface messages are transferred on the data lines of the IEC/IEEE bus when the "ATN" control line is active (LOW). They are used for communication between controller and instruments and can only be sent by the controller which currently has control of the IEC/IEEE bus.

### Universal Commands

The universal commands are encoded 10 - 1F hex. They affect all instruments connected to the bus without addressing.

Table 8-2 Universal Commands

Command	VISUAL BASIC command	Effect on the instrument
DCL (Device Clear)	IBCMD (controller%, CHR\$(20))	Aborts the processing of the commands just received and sets the command processing software to a defined initial state. Does not change the instrument settings..
IFC (Interface Clear)	IBSIC (controller%)	Resets the interfaces to the default setting.
LLO (Local Lockout)	IBCMD (controller%, CHR\$(17))	Locks switchover from remote control to manual control by means of the front panel keys
SPE (Serial Poll Enable)	IBCMD (controller%, CHR\$(24))	Ready for serial poll.
SPD (Serial Poll Disable)	IBCMD (controller%, CHR\$(25))	End of serial poll.
PPU (Parallel Poll Unconfigure)	IBCMD (controller%, CHR\$(21))	End of the parallel-poll state.

### Addressed Commands

The addressed commands are encoded 00 - 0F hex. They are only effective for instruments addressed as listeners.

Table 8-3 Addressed Commands

Command	VISUAL BASIC Command	Effect on the instrument
SDC (Selected Device Clear)	IBCLR (device%)	Aborts the processing of the commands just received and sets the command processing software to a defined initial state. Does not change the instrument setting.
GET (Group Execute Trigger)	IBTRG (device%)	Triggers a previously active device function (e.g. a sweep). The effect of the command is the same as with that of a pulse at the external trigger signal input.
GTL (Go to Local)	IBLOC (device%)	Transition to the "Local" state (manual control).
PPC (Parallel Poll Configure)	IBPPC (device%, data%)	Configures instrument for parallel poll. Additionally, the VISUAL BASIC command executes PPE/PPD.



## LAN Connector

The unit is equipped with an LAN interface as standard. The LAN connector is at the rear of the instrument. Provided the appropriate rights have been assigned by the network administrator, files can be transmitted via the network, and network resources, e.g. a network folders, can be used. The instrument can also be remote-controlled and manually operated in the network. It is connected by means of a commercial RJ45 cable.

The network card functions with 100 MHz Ethernet IEEE 802.3u. The TCP/IP network protocol and the associated network services are preconfigured. TCP/IP ensures connection-oriented communication, where the order of the exchanged messages is adhered to and interrupted links are identified. With this protocol, messages cannot be lost.

Connection of the Vector Signal Generator is described in Chapter 1, section "[Connection to the Network](#)", remote control via Ethernet in chapter 5, section "[Remote Control via LAN Interface](#)", page 5.5. The architecture of a LAN remote-control connection is described in detail in the following.

Remote control of an instrument via a network is based on standardized protocols which follow the OSI reference model (see Fig. below).

Application	SCPI	SCPI [3]
Presentation	XDR (VXI-11)	RFC 1014 [1,2]
Session	ONC-RPC	RFC 1057
Transport	TCP / UDP	RFC 793
Network	IP	RFC 791
Data Link	Ethernet/802.3	8802-3
Physical	802.3/10BASE-T	8802-3

Fig. 8-2 Example for LAN remote control based on the OSI reference model

Based on TCP/UDP, messages between the controller and the instrument are exchanged via open network computing (ONC) - remote procedure calls (RPC). With XDR, legal RPC messages are known as VXI-11 standard. Based on this standard, messages are exchanged between the controller and the instrument. The messages are identical with SCPI commands. They can be organized in four groups: program messages (control command to the instrument), response messages (values returned by the instrument), service request (spontaneous queries of the instrument) and low-level control messages (interface messages).

A VXI-11 link between a controller and an instrument uses three channels: a core, abort and interrupt channel. Instrument control is mainly performed on the core channel (program, response and low-level control messages). The abort channel is used for immediate abort of the core channel; the interrupt channel transmits spontaneous service requests of the instrument. Link setup itself is very complex. For more details refer to the VXI-11 specification ("TCP/IP Instrument Protocol Specification VXI-11, Revision 1.0 VMEbus Extensions for Instrumentation, VXIbus", and "TCP/IP-IEEE 488.2 Instrument Interface Specification VXI-11.3, Draft 0.3 VMEbus Extensions for Instrumentation, VXIbus").

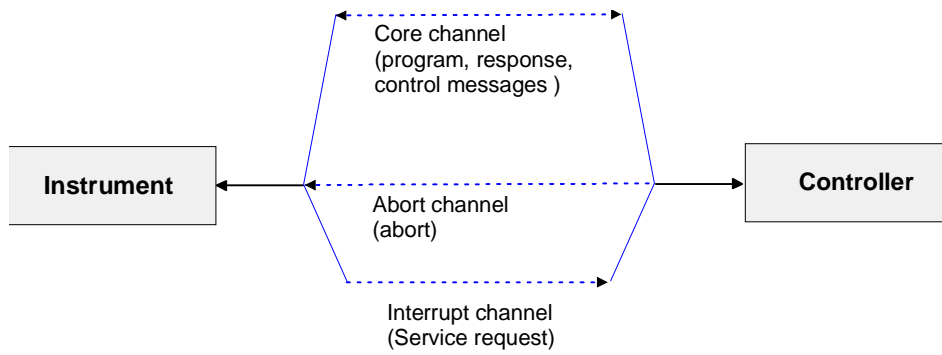

Fig. 8-3 VXI-11 channels between instrument and controller

The number of controllers that can address an instrument is practically unlimited in the network. In the instrument, the individual controllers are clearly distinguished. This distinction continues up to the application level in the controller, i.e. two applications on a PC are identified by the instrument as two different controllers.

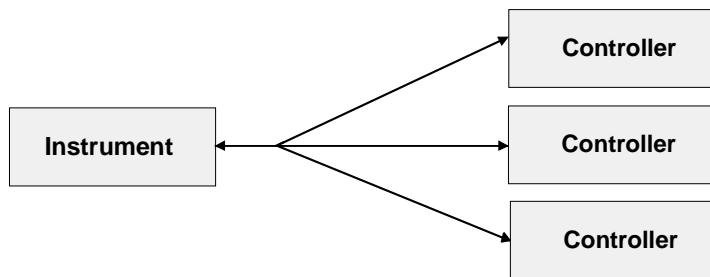
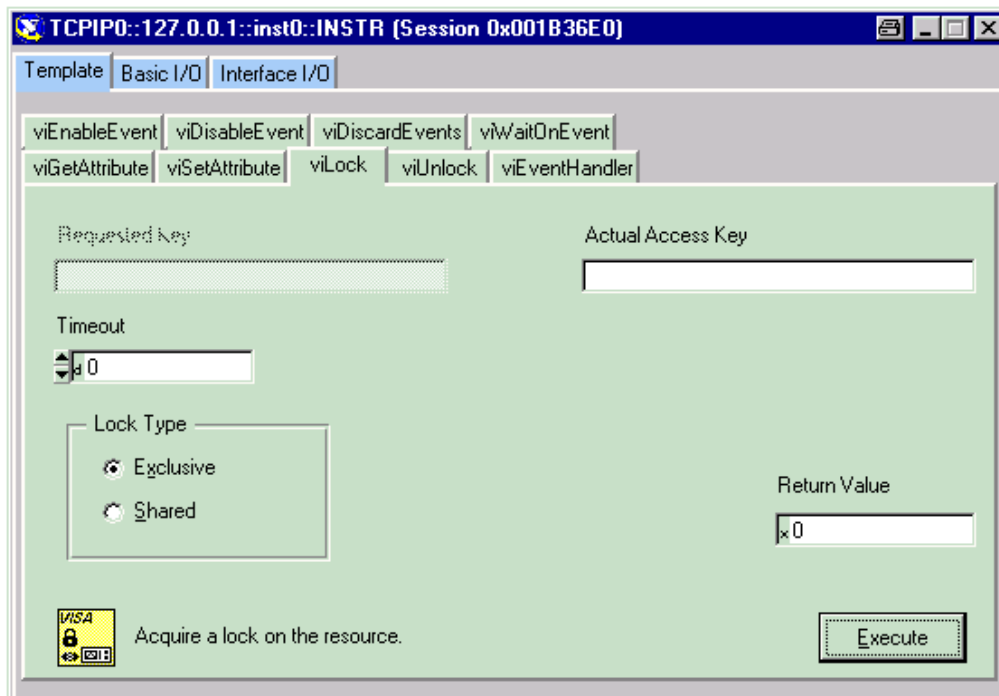

Fig. 8-4 Remote control via LAN from several controllers

The controllers can lock and unlock the instrument for exclusive access. This regulates access to the instrument of several controllers.

In the **'Measurement & Automation Control'** program, this setting is made on the **Template** tab.



## VXI-11 Interface Messages

On the Ethernet link, the interface messages are called low-level control messages. These messages can be used to emulate interface messages of the IEC/IEEE bus.

Table 8-4 VXI-11 Interface Messages

Command	Effect on the instrument
&ABO (Abort)	Aborts the processing of the commands just received.
&DCL (Device Clear)	Aborts the processing of the commands just received and sets the command processing software to a defined initial state. Does not change the instrument setting.
&GTL (Go to Local)	Transition to the "Local" state (manual control)
&GTR (Go to Remote)	Transition to the "Remote" state (remote control)
&GET (Group Execute Trigger)	Triggers a previously active device function (e.g. a sweep). The effect of the command is the same as with that of a pulse at the external trigger signal input.
&LLO (Local Lockout)	Disables switchover from remote control to manual control by means of the front panel keys
&POL (Serial Poll)	Starts a serial poll
&NREN (Not Remote Enable)	Enables switchover from remote control to manual control by means of the front panel keys

## USB Connection (USB and USB IN)

The instrument is equipped as standard with four USB (universal serial bus) interfaces.

### USB

Three of them are type A interfaces (host USB) which establish a connection to the controller. They can be used for connecting peripherals such as mouse and keyboard or a memory stick for data transmission. Two of the master USBs are at the instrument front, the third is at the rear.

### USB IN

The fourth USB interface is a type B interface (device USB) and located at the rear of the instrument. It establishes a connection to the DACIF module and can be used for data transmission

If required, separate drivers can be developed for this interface. The device ID required in this case is 11 (HEX) for remote control and 12 (HEX) for the transmission of modulation data. The vendor ID is AAD (HEX).

### Monitor Connector (MONITOR)

The 15-pin Sub-D female connector MONITOR at the rear panel is intended for connecting an external VGA monitor.

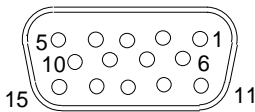

Pin	Signal	Pin	Signal	Pin	Signal
1	Red (output)	6	GND	11	(NC)
2	Green (output)	7	GND	12	(NC)
3	Blue (output)	8	GND	13	HSYNC (output)
4	(NC)	9	GND	14	VSYNC (output)
5	GND	10	GND	15	(NC)

Figure 8-5 Pin assignment of the MONITOR connector

## Contents - Chapter 9 - "Error Messages"

<b>9 Error Messages .....</b>	<b>9.1</b>
<b>Introduction - Status Information and Messages.....</b>	<b>9.1</b>
<b>Status Information.....</b>	<b>9.1</b>
<b>Error Messages.....</b>	<b>9.3</b>
<b>Alphabetical List of SCPI-Error Messages.....</b>	<b>9.4</b>
Block data not allowed (-168).....	9.4
Character data not allowed (-148) .....	9.4
Character data too long (-144) .....	9.4
Command Error (-100) .....	9.4
Command protected (-203) .....	9.4
Data out of range (-222).....	9.5
Data type error (-104).....	9.5
Device-specific error (-300).....	9.5
Exponent too large (-123) .....	9.5
Expression data not allowed (-178) .....	9.5
GET not allowed (-105) .....	9.5
Hardware error (-240) .....	9.5
Hardware missing (-241).....	9.6
Header suffix out of range (-114) .....	9.6
Illegal parameter value (-224) .....	9.6
Invalid block data (-161).....	9.6
Invalid Character (-101) .....	9.6
Invalid separator (-103).....	9.6
Invalid suffix (-131).....	9.7
Lists not same length (-226).....	9.7
Missing parameter (-109) .....	9.7
No error (0).....	9.7
Numeric data not allowed (-128).....	9.7
Out of memory (-225).....	9.7
Parameter not allowed (-108).....	9.7
Program mnemonic too long (-112) .....	9.8
Queue overflow (-350) .....	9.8
Query interrupted (-410).....	9.8
Query unterminated (-420).....	9.8
Query deadlocked (-430) .....	9.8
Self test failed ... (-330).....	9.8
Settings conflict ... (-221) .....	9.9
String data not allowed (-158).....	9.9
Suffix not allowed (-138) .....	9.9
Suffix too long (-134).....	9.9
Syntax error (-102).....	9.9

System error (-310) .....	9.9
Too many digits (-124) .....	9.9
Too much data (-223).....	9.10
Undefined header (-113).....	9.10
<b>Alphabetical List of Device-Specific Error Messages .....</b>	<b>9.10</b>
Adjustment data invalid (183).....	9.10
Adjustment data missing (182).....	9.10
Adjustment failed (180) .....	9.10
Cannot access the EEPROM (202) .....	9.11
Cannot access hardware (200) .....	9.11
Cannot open file (460).....	9.11
Cannot read file (462) .....	9.11
Cannot write file (461) .....	9.11
Driver initialization failed (204).....	9.11
File contains invalid data (465) .....	9.12
Filename missing (463).....	9.12
Hardware revision out of date (201).....	9.12
Invalid EEPROM data (203).....	9.12
Invalid filename extension (464) .....	9.12
No current list (241).....	9.12
This modulation forces other modulations off (140).....	9.13
Unknown list type specified (242) .....	9.13
Waveform Protected (261) .....	9.13

## 9 Error Messages

### Introduction - Status Information and Messages

This chapter describes the error messages of the signal generator. The error messages are output in the **Info** line on the screen and entered in the error error/event queue of the status reporting system.

A great variety of different messages such as status messages, error messages, warnings or information are displayed in the header field of the screen. Some error messages require that the error must be eliminated before correct instrument operation can be ensured. The info window with a list of current messages and a detailed description of each message can be opened with the **INFO** key

In the remote control mode, error messages are entered in the error/event queue of the status reporting system and can be queried with the command `SYSTEM:ERROR?`. If the error queue is empty, 0 ("No error") is returned.

### Status Information

The status messages are displayed in the header section of the screen. The status information gives the user an overview of the main operating states and settings of the signal generator. The states are indicated for information only and do not necessitate any action by the user. Status information is displayed between the frequency and level fields, at the left of the info line or in the info line itself. On two-path instruments, all states that can occur independently in the two paths are displayed separately for each path. The associated path is indicated in the info line.

#### Status information displayed between the frequency and level fields:

**RF OFF**            The RF output is switched off

**MOD OFF**        All modulations are switched off.

**FREQ OFFSET**    A frequency offset is set.

The frequency entered and displayed in the frequency field takes any set frequency offset into consideration, e.g. an offset set for a downstream instrument. This means that with a frequency offset the frequency displayed in the header does not correspond to the frequency at the RF output, but rather to the frequency at the output of the downstream instrument.

This allows the desired frequency at the output of a downstream instrument to be entered in the frequency field. The signal generator changes the RF output frequency according to the entered offset.

However, the frequency entered and displayed in the Frequency/Phase menu of the RF/Ana Mod function block always corresponds to the RF output frequency. Any frequency offset is not taken into consideration.

The correlation is as follows:

**Freq in header = RF output frequency (= Freq in menu) + Freq offset (= Offset in menu)**

**LEVEL OFFSET** A level offset is set.

The level entered and displayed in the Level field takes the offset of any downstream attenuators/amplifiers into consideration by way of calculation. This means that with a level offset the level displayed in the header does not correspond to the level at the RF output, but rather to the level at the output of the downstream instrument.

This allows the desired level at the output of downstream instruments to be entered. The signal generator changes the RF output level according to the set offset.

However, the level entered and displayed in the **Level** menu of the **RF/Ana Mod** function block always corresponds to the RF output level. Any level offset is not taken into consideration.

The correlation is as follows:

$$\text{Level in header} = \text{RF output level} (= \text{Level in menu}) + \text{Level offset}$$

**EXT REF** An external reference is used.

The external signal with selectable frequency and defined level must be input at the REF IN connector. It is output at the REF OUT connector.

The reference frequency setting is effective for both paths.

**BUSY** A setting is calculated.

**Status information displayed to the left of the Info line:**

**REMOTE** The instrument is remote controlled.

The **LOCAL** key switches the instrument from remote control to manual control. The current command must be fully processed before the mode is switched, otherwise the instrument switches immediately back to remote control.

**REM LLO** The instrument is remote controlled.

The instrument can be switched from remote control to manual control by means of remote control only (e.g. with the Visual Basic command `CALL IBLOC (generator%)`); the **LOCAL** key is disabled. The key is disabled by remote control with the command LLO.

**Status information displayed in the Info line:**

**RFSweep** The indicated sweep is enabled.  
**LevelSweep**  
**LFSweep**

**ALC On/Auto/S&H** The status of the automatic level control is indicated:

- ON = automatic level control permanently on
- Auto = automatic level control is automatically adapted to the operating states
- S&H = automatic level control off, recalibration of the level whenever the level or frequency is set (sample and hold mode).



<b>ListMode</b>	List mode is active.  The values of the frequency/level pairs in the selected list are set for the chosen dwell time.
<b>AttFixed</b>	Attenuator fixed mode is active.  The uninterrupted level settings are made in a fixed range without attenuator switching. The variation range is set automatically when this mode is activated. The range is displayed under <b>Attenuator Fixed Range</b> in the <b>Level</b> menu.
<b>UCorr</b>	User Correction is active.  The level is corrected by the given values in the selected user correction list. Correction is performed by the user-defined list values being added to the output level for the respective RF frequency. With frequencies which are not contained in the list, the level correction is determined by interpolation of the closest correction values.
<b>OvenCold</b>	The reference oscillator has not yet reached its nominal frequency.  When switching on from the STANDBY mode, the specified frequency accuracy is reached immediately. If the power switch was switched off, the reference oscillator needs some warm-up time to reach its nominal frequency. During this period of time, the output frequency does not yet reach its final value either.

## Error Messages

Messages indicate errors in the instrument. They are displayed in the info line in different colors depending on their importance and display duration. Errors (e.g. no calibration data) are displayed in red, information (e.g. file not found) and warnings in black. Warnings indicate less significant errors (e.g. the instrument operates outside specified data).

### Brief messages

Brief messages report automatic settings in the instrument (e.g. switching off of incompatible types of modulation) or on illegal entries that are not accepted by the instrument (e.g. range violations). They are displayed in the info line on a yellow background. They are displayed on top of status information or permanent messages.

Brief messages do not normally demand user actions and disappear automatically after a brief period of time. They are stored in the history, however.

### Permanent messages

Permanent messages are displayed if an error occurs that impairs further instrument operation, e.g. a hardware fault. The error signaled by a permanent message must be eliminated before correct instrument operation can be ensured.

The message is displayed until the error is eliminated. It covers the status display in the info line. After error elimination, the message automatically disappears and is also recorded in the history.

## Alphabetical List of SCPI-Error Messages

The following list contains all error messages defined in SCPI in alphabetical order. SCPI error messages are the same in all SCPI instruments. The errors are assigned negative numbers.

The error text being entered into the error/event queue or being displayed is printed in bold face on the left together with the error code. Below the error text, there is an explanation as to the respective error.

---

**Note:** *The index provides a list of the error messages sorted according to their error codes.*

---

### Block data not allowed (-168)

The command contains legal block data which are not allowed at this point.

**Example:** The command `SOUR:FREQ` requires a numeric parameter - `FREQ #13a`

**SCPI:** Command error - sets bit 5 in the ESR register

### Character data not allowed (-148)

The character data is prohibited for this command or at this point of the command.

**Example:** Command `SOURce:FREQuency` requires a numeric parameter.

**SCPI:** Command error - sets bit 5 in the ESR register

### Character data too long (-144)

The character data element contains more than 12 characters.

**SCPI:** Command error - sets bit 5 in the ESR register

### Command Error (-100)

Generic error message that cannot detect a more specific error.

**SCPI:** Command error - sets bit 5 in the ESR register

### Command protected (-203)

The desired command could not be executed as it was protected with a password.

**Example:** The command `CAL:FREQ?` might be protected with a password.

**Remedy** Use command `:SYST:PROT1 OFF, 123456` to enable the command.

**SCPI:** Execution error - sets bit 4 in the ESR register

**Data out of range (-222)**

A value of the transmitted command was outside the legal range.

**Example:** Command `SOUR:FREQ` only permits entries in the range of min to max frequency.

**SCPI:** Execution error - sets bit 4 in the ESR register

**Data type error (-104)**

The command contains an invalid value indication.

**Example:** ON is indicated instead of a numeric value for frequency setting -  
`:FREQ ON`

**SCPI:** Command error - sets bit 5 in the ESR register

**Device-specific error (-300)**

Device-specific error not defined in greater detail.

**SCPI:** Device-specific error - sets bit 3 in the ESR register

**Exponent too large (-123)**

The magnitude of the exponent is too large.

**SCPI:** Command error - sets bit 5 in the ESR register

**Expression data not allowed (-178)**

The command contains a mathematical expression at an impermissible position.

**SCPI:** Command error - sets bit 5 in the ESR register

**GET not allowed (-105)**

A Group Execute Trigger (GET) is within a command line.

**Note:** A Group Execute Trigger (GET) is only allowed at the end of a command line or in a separate command line.

**SCPI:** Command error - sets bit 5 in the ESR register

**Hardware error (-240)**

A legal program command or a query could not be executed because of a hardware problem in the device.

**SCPI:** Execution error - sets bit 4 in the ESR register

**Hardware missing (-241)**

A legal program command or a query could not be executed because of a missing device hardware.

**Example:** An option is not fitted.

**SCPI:** Execution error - sets bit 4 in the ESR register

**Header suffix out of range (-114)**

The command contains an illegal numeric suffix.

**Example:** :SOURce22 is not defined for the signal generator.

**SCPI:** Command error - sets bit 5 in the ESR register

**Illegal parameter value (-224)**

The parameter value is invalid.

**Example:** An invalid text parameter is indicated -  
:SOUR:BB:GSM:TRIG:SOUR TASTe

**SCPI:** Execution error - sets bit 4 in the ESR register

**Invalid block data (-161)**

The command contains illegal block data.

**Example:** An END message was received before the expected number of data had been received or no numeric data element is sent after the introductory #

**SCPI:** Command error - sets bit 5 in the ESR register

**Invalid Character (-101)**

The command contains an invalid sign.

**Example:** A header contains an ampersand, "SOURCE&".

**SCPI:** Command error - sets bit 5 in the ESR register

**Invalid separator (-103)**

The command contains an impermissible sign instead of a separator.

**Example:** A semicolon is missing after the first command in a command line with several commands -  
":FREQ 2MHz POW -25".

**SCPI:** Command error - sets bit 5 in the ESR register

**Invalid suffix (-131)**

The suffix is not appropriate for this command.

**Example:** nHz is not defined.

**SCPI:** Command error - sets bit 5 in the ESR register

**Lists not same length (-226)**

The parts of a list have different lengths. This error message is also displayed if only part of a list has been transmitted via IEC bus. All parts of the list have to be transmitted always before it is executed.

**Example:** The POWER list content is longer than the FREQUENCY list content, or only the POWER content is transmitted.

**SCPI:** Execution error - sets bit 4 in the ESR register

**Missing parameter (-109)**

The command does not contain the required parameters.

**Example:** Command :SOUR:FREQ requires the indication of a parameter -  
":FREQ; POW -35"

**SCPI:** Command error - sets bit 5 in the ESR register

**No error (0)**

This message is output if the error queue does not contain entries.

**Numeric data not allowed (-128)**

The command contains a numeric data element the device does not accept in this position.

**Example:** The command :SOUR:BB:MCCW:SEQ requires the indication of a text parameter - SOUR:BB:MCCW:SEQ AUTO.

**SCPI:** Command error - sets bit 5 in the ESR register

**Out of memory (-225)**

The storage space available in the instrument is exhausted.

**SCPI:** Execution error - sets bit 4 in the ESR register

**Parameter not allowed (-108)**

The command contains too many parameters.

**Example:** Command SOURCE:FM:INTERNAL:FREQUENCY permits only one frequency indication - ":FREQ:CENT 30 kHz, 40 kHz".

**SCPI:** Command error - sets bit 5 in the ESR register

**Program mnemonic too long (-112)**

The header contains more than 12 characters.

**SCPI:** Command error - sets bit 5 in the ESR register

**Queue overflow (-350)**

This error code is entered into the queue instead of the actual error code if the queue is full. It indicates that an error has occurred but not been recorded in the queue. The original error message is lost.

**Remedy:** Reading out the error messages e.g. with command `SYSTem:ERRor:ALL?` clears the error queue.

**SCPI:** Device specific error- sets bit 3 in the ESR register

**Query interrupted (-410)**

This query has been interrupted.

**Example** After a query, the instrument receives new data before the response has been sent completely.

**SCPI:** Query error - error in data request - sets bit 2 in the ESR register.

**Query unterminated (-420)**

This query is missing or incomplete.

**Example** The instrument is addressed as a talker and receives incomplete data.

**SCPI:** Query error - error in data request - sets bit 2 in the ESR register.

**Query deadlocked (-430)**

This query cannot be processed.

**Example** The input and output buffers are full, the instrument cannot be operated.

**SCPI:** Query error - error in data request - sets bit 2 in the ESR register.

**Self test failed ... (-330)**

An error was detected in the selftest named after the semicolon. An error-free operation of the module concerned is no longer guaranteed.

**SCPI:** Device specific error- sets bit 3 in the ESR register

**Settings conflict ... (-221)**

There is a setting conflict between the two parameters indicated after the semicolon.

**Example:** The set FSK deviation is too large for the selected symbol rate.

**Remedy** One of the given values has to be corrected to obtain a valid output signal.

**SCPI:** Execution error - sets bit 4 in the ESR register

**String data not allowed (-158)**

The command contains a legal string data element which is not allowed at this point.

**Example:** A text parameter is set in quotation marks -  
SOURCE:FREQUENCY:MODE "FIXed" .

**SCPI:** Command error - sets bit 5 in the ESR register

**Suffix not allowed (-138)**

A suffix is not allowed for this command or at this point of the command.

**Example:** Command \*RCL does not permit indicating a suffix.

**SCPI:** Command error - sets bit 5 in the ESR register

**Suffix too long (-134)**

The suffix contains more than 12 characters.

**SCPI:** Command error - sets bit 5 in the ESR register

**Syntax error (-102)**

The command is invalid.

**Example:** The command contains block data the instrument does not accept.

**SCPI:** Command error - sets bit 5 in the ESR register

**System error (-310)**

This error message suggests an error within the instrument. Please inform the R&S Service.

**SCPI:** Device specific error- sets bit 3 in the ESR register

**Too many digits (-124)**

The decimal numeric data element contains too many digits.

**SCPI:** Command error - sets bit 5 in the ESR register

**Too much data (-223)**

More data were sent by the host than the signal generator can handle.

**SCPI:** Execution error - sets bit 4 in the ESR register

**Undefined header (-113)**

The sent command header has not been defined.

**Example:** Header : \*XYZ is undefined for every instrument.

**SCPI:** Command error - sets bit 5 in the ESR register

## Alphabetical List of Device-Specific Error Messages

The following list contains all error messages specific of the instrument in alphabetical order. The positive error codes mark the errors specific of the instrument.

The error text being entered into the error/event queue or being displayed is printed in bold face on the left together with the error code. Below the error text, there is an explanation as to the respective error.

---

**Note:** *The index provides a list of the error messages sorted according to their error codes.*

---

**Adjustment data invalid (183)**

Adjustment data are invalid and must be restored.

**Remedy:** The adjustment data have to be generated again by an internal or external adjustment or to be loaded into the instrument.

**SCPI:** Device-specific error - sets bit 3 in the ESR register

**Adjustment data missing (182)**

Adjustment data are missing.

**Remedy:** The adjustment data have to be generated first by an internal or external adjustment or to be loaded into the instrument.

**SCPI:** Device-specific error - sets bit 3 in the ESR register

**Adjustment failed (180)**

Adjustment could not be executed

**Remedy:** The adjustment data have to be generated first by an internal or external adjustment or to be loaded into the device (see section Adjustment).

**SCPI:** Device-specific error - sets bit 3 in the ESR register



**Cannot access the EEPROM (202)**

A error occurs when writing or reading a EEPROM.

**Example:** The EEPROM is defect.

**SCPI:** Device-specific error - sets bit 3 in the ESR register

**Cannot access hardware (200)**

The data transmission to a module was unsuccessful.

**Example:** The module is not installed, not properly installed or missing.

**SCPI:** Device-specific error - sets bit 3 in the ESR register

**Cannot open file (460)**

The selected file can not be opened.

**Remedy:** Check the path and file name.

**SCPI:** Device-specific error - sets bit 3 in the ESR register

**Cannot read file (462)**

The file can not be read.

**Example:** The file contents are not compatible with the file type.

**SCPI:** Device-specific error - sets bit 3 in the ESR register

**Cannot write file (461)**

The file can not be written.

**Example:** The file is read-only.

**SCPI:** Device-specific error - sets bit 3 in the ESR register

**Driver initialization failed (204)**

Initialization of a driver fails when booting the instrument firmware

**Example:** The driver is not compatible with the hardware or software configuration of the instrument.

**SCPI:** Device-specific error - sets bit 3 in the ESR register

**File contains invalid data (465)**

The selected file contains data that is not valid for the file type. The file extension determines the data that is valid for this file type. If the file extension is changed the lists are no longer recognized and the data are therefore invalid.

**Example:** The extension of a waveform file (= \*.wv) was changed to \*.txt.

**SCPI:** Device-specific error - sets bit 3 in the ESR register

**Filename missing (463)**

The desired operation cannot be execute because the file name is not specified.

**Example:** A file name has to be entered when creating a new list.

**SCPI:** Device-specific error - sets bit 3 in the ESR register

**Hardware revision out of date (201)**

A later version of certain parts of the instrument is necessary to execute the function selected.

**Example:** The driver does not support the installed version of a module.

**SCPI:** Device-specific error - sets bit 3 in the ESR register

**Invalid EEPROM data (203)**

Reading a EEPROM is possible, however the data are inconsistent.

**SCPI:** Device-specific error - sets bit 3 in the ESR register

**Invalid filename extension (464)**

The file extension is not valid for the desired operation.

**Example:** The file extension for list mode files is \*.lsw. It is not possible to enter another file extension when storing a list.

**SCPI:** Device-specific error - sets bit 3 in the ESR register

**No current list (241)**

There is no list selected. To execute the desired operation a list has to be selected in the related menu. If no list is available, a new list must be created.

**Example:** The list mode is enable without a list being selected.

**SCPI:** Device-specific error - sets bit 3 in the ESR register

**This modulation forces other modulations off (140)**

A modulation has been switched on which cannot be used at the same time as an already active modulation. The previous modulation has been switched off.

**Example:** Enabling modulation GSM/EDGE switches any active digital modulation off.

**SCPI:** Device-specific error - sets bit 3 in the ESR register

**Unknown list type specified (242)**

The list type selected is not valid for the desired operation

**Example:** The file extension for list mode files is **\*.lsw**. It is not possible to enter another file extension when selecting a list.

**SCPI:** Device-specific error - sets bit 3 in the ESR register

**Waveform Protected (261)**

The selected waveform file cannot be transferred to a controller. The waveform is produced with simulation software WinIQSIM and is protected.

**SCPI:** Device-specific error - sets bit 3 in the ESR register



## Index

**&**

&GTL.....	5.3
&GTR.....	5.3
&LLO.....	5.3

**(**

(Mis-) use for output power control - BS - CDMA2000.....	6.158, 4.591
(Mis-) use for output power control - MS - CDMA2000.....	6.184, 4.607
(Mis-) use TPC for output power control DPCCH - BS - 3GPP FDD.....	6.522, 4.401
(Mis-) use TPC for output power control DPCCH - UE - 3GPP FDD.....	6.590, 4.447
(Mis-) use TPC for output power control F-DPCH - BS - 3GPP FDD.....	6.525
(SF For Each) Physical Channel Codes – HSUPA FRC - 3GPP FDD.....	6.597, 4.467

**\***

*CLS.....	6.4
*ESE.....	6.4
*ESE?.....	6.4
*ESR?.....	6.5
*IDN?.....	6.5
*IST?.....	6.5
*OPC.....	6.5
*OPC?.....	6.5
*OPT?.....	6.5
*PRE.....	6.5
*PRE?.....	6.5
*PSC.....	6.5
*PSC?.....	6.5
*RCL.....	6.6
*RST.....	6.6, 6.8
*SAV.....	6.6
*SRE.....	6.6
*SRE?.....	6.6
*STB?.....	6.6
*TRG.....	6.7
*TST?.....	6.7
*WAI.....	6.7

...Current Frequency.....	6.11, 4.7
...Full Range.....	6.11, 4.8

**0**

0 - No error.....	9.7
-------------------	-----

**1**

-100 - Command Error.....	9.4
-101 - Invalid Character.....	9.6

-102 - Syntax error.....	9.9
-103 - Invalid separator.....	9.6
-104 - Data type error.....	9.5
-108 - Parameter not allowed.....	9.7
-109 - Missing parameter.....	9.7
-112 - Program mnemonic too long.....	9.8
-113 - Undefined header.....	9.10
-114 - Header suffix out of range.....	9.6
-123 - Exponent too large.....	9.5
-124 - Too many digits.....	9.9
-128 - Numeric data not allowed.....	9.7
-131 - Invalid suffix.....	9.7
-134 - Suffix too long.....	9.9
-138 - Suffix not allowed.....	9.9
140 - This modulation forces other modulations off.....	9.13
-144 - Character data too long.....	9.4
-148 - Character data not allowed.....	9.4
-158 - String data not allowed.....	9.9
-161 - Invalid block data.....	9.6
-168 - Block data not allowed.....	9.4
180 - Adjustment failed.....	9.10
182 - Adjustment data missing.....	9.10
183 - Adjustment data invalid.....	9.10

**2**

200 - Cannot access hardware.....	9.11
201 - Hardware revision out of date.....	9.12
202 - Cannot access the EEPROM.....	9.11
-203 - Command protected.....	9.4
203 - Invalid EEPROM data.....	9.12
204 - Driver initialization failed.....	9.11
-221 - Settings conflict.....	9.9
-222 - Data out of range.....	9.5
-223 - Too much data.....	9.10
-224 - Illegal parameter value.....	9.6
-225 - Out of memory.....	9.7
-226 - Lists not same length.....	9.7
-240 - Hardware error.....	9.5
-241 - Hardware missing.....	9.6
241 - No current list.....	9.12
242 - Unknown list type specified.....	9.13
261 - Waveform protected.....	9.13
2 <sup>nd</sup> Search Code Group - BS - 3GPP FDD.....	6.545, 4.354

**3**

-300 - Device-specific error.....	9.5
-310 - System error.....	9.9
-330 - Self-test failed.....	9.8
-350 - Queue overflow.....	9.8
3GPP Version.....	6.493, 4.324

**4**

-410 - Query deadlocked.....	9.8
-410 - Query interrupted.....	9.8
-410 - Query unterminated.....	9.8
460 - Cannot open file.....	9.11
461 - Cannot write file.....	9.11
462 - Cannot read file.....	9.11
463 - Filename missing.....	9.12

464 - Invalid filename extension ..... 9.12  
 465 - File contains invalid data ..... 9.12

**A**

Abort button ..... 3.23  
 Aborting a calculation ..... 3.23  
 Accept - Copy - 3GPP FDD ..... 6.489, 4.330  
 Accept - Copy - CDMA2000 ..... 6.116, 4.553  
 Accept - Copy - TD-SCDMA ..... 6.322  
 Accept - MCCW ..... 6.302, 4.250  
 Accept - Predefined Settings - CDMA2000 ..... 6.137  
 Accept - Predefined Settings - TD-SCDMA ..... 6.341  
 Accept - Predefined Settings - CDMA2000 ..... 4.570  
 Accept - Predefined Settings 3GPP FDD ..... 6.508, 4.351  
 Accept Carrier Table - MCCW ..... 4.251  
 Accept Copy - TD-SCDMA ..... 4.754  
 Access - MS - CDMA2000 ..... 6.181, 4.604  
 Access Burst - GSM/EDGE ..... 6.261, 4.295  
 Access denied ..... 3.15  
 Access Slot - BS - 3GPP FDD ..... 6.515, 4.406  
 Activate Cell ..... 4.755  
 Activate Cell - TD-SCDMA ..... 4.770  
 Activate Slot - TD-SCDMA ..... 6.343, 4.772  
 Activate TD-SCDMA Standard ..... 4.748  
 Activate Transport Channel - TD-SCDMA ..... 6.351, 6.358  
 Activating noise generator ..... 6.52  
 Add OCNS - BS - 3GPP FDD ..... 6.543, 4.326  
 Additional MS - CDMA2000 ..... 6.174, 4.571  
 Additional UE - 3GPP FDD ..... 6.575, 4.351  
 Additive Noise ..... 6.48, 4.136  
 Addresses - WLAN ..... 4.637  
 Adjust All ..... 6.10, 4.6  
 Adjust Baseband Input ..... 4.8  
 Adjust FM Offset ..... 6.10  
 Adjust I/Q modulator ..... 6.11, 4.7  
 Adjust Level ..... 6.13, 4.7  
 Adjust Synthesis ..... 6.11, 4.7  
 Adjust Synthesis Extension ..... 4.7  
 Adjust Total Power to 0 dB - 3GPP FDD ..... 6.494, 4.331  
 Adjust Total Power to 0 dB - CDMA2000 ..... 6.123, 4.554  
 Adjust Total Power to 0 dB - GPS ..... 6.226, 4.729  
 Adjust Total Power to 0 dB - TD-SCDMA ..... 6.325, 4.754  
 Adjustment Active ..... 6.735, 4.48  
 Adjustment data invalid (183) ..... 9.10  
 Adjustment data missing (182) ..... 9.10  
 Adjustment failed (180) ..... 9.10  
 Adjustment Frequency ..... 6.735, 4.49  
 Adjustment Path A/B ..... 4.7  
 Adjustment value - Reference frequency ..... 6.735, 4.49  
 AICH Settings - 3GPP FDD ..... 4.406  
 AICH Transmission Timing PCPCH - UE - 3GPP FDD ..... 6.610, 4.435  
 AICH Transmission Timing PRACH - UE - 3GPP FDD ..... 6.619  
 AICH Transmission Timing RACH - UE - 3GPP FDD ..... 4.426  
 ALC (automatic level control) ..... 6.725, 4.55  
 ALC On ..... 4.55  
 ALC-Auto ..... 9.2  
 ALC-Off ..... 9.2  
 ALC-On ..... 9.2  
 ALC-S&H ..... 9.2  
 ALL 0|1 - GSM/EDGE ..... 4.270, 4.298  
 All Data EDGE Burst - GSM/EDGE ..... 6.261, 4.295  
 All Data GSM Burst - GSM/EDGE ..... 6.261, 4.295  
 Allocated Subchannel Bitmap - WiMAX ..... 6.426  
 Allocated Subchannels Bitmap ..... 4.689  
 Allocation Start Time Base - WiMAX ..... 4.677, 4.701  
 Almanac File - GPS ..... 6.241, 4.727  
 Almanac for GPS week ... - GPS ..... 6.241, 6.242, 6.243, 6.244, 4.727  
 Almanac Time of Ephemeris (TOE) - GPS ..... 6.245  
 Altitude - GPS ..... 6.223, 4.724  
 AM Depth ..... 6.41, 4.99  
 AM External Coupling ..... 6.42, 4.99  
 AM External Impedance ..... 6.689, 4.100  
 AM Frequency ..... 6.699, 4.100  
 AM Sensitivity ..... 6.41, 6.42, 4.99, 4.102  
 AM Source ..... 6.42, 4.99  
 AM State ..... 6.43, 4.98  
 Analog Wideband I/Q In ..... 6.693, 4.115  
 AP-AICH Settings - 3GPP FDD ..... 4.406  
 Append - ARB ..... 4.231  
 Apply - Test Case Wizard - 3GPP ..... 6.655, 4.489  
 Apply Assistant Settings - ARB MCAR ..... 6.66, 4.241  
 ARB - Arbitrary Waveform Generator ..... 6.56, 4.206  
 ARB Marker - TD-SCDMA ..... 4.765  
 ARB Sequence Length - UE - 3GPP FDD ..... 4.427, 4.436  
 ARB-Settings - TD-SCDMA ..... 4.752  
 Architecture of R&S SMATE ..... 2.1  
 Arm Trigger - 3GPP FDD ..... 4.340  
 Arm Trigger - 3GPP FDD ..... 6.498  
 Arm Trigger - ARB ..... 6.75  
 Arm Trigger - ARB ..... 4.222  
 Arm Trigger - CDMA2000 ..... 6.126, 4.562  
 Arm Trigger - DM ..... 6.201, 4.200  
 Arm Trigger - GPS ..... 6.230, 4.735  
 Arm Trigger - GSM/EDGE ..... 6.279, 4.285  
 Arm Trigger - MCCW ..... 6.307, 4.255  
 Arm Trigger - TD-SCDMA ..... 6.331, 4.752, 4.763  
 Arm Trigger - WiMAX ..... 6.392, 4.711  
 Arm Trigger - WLAN ..... 6.645  
 Arm Trigger - WLAN ..... 6.464  
 Armed\_Auto - 3GPP FDD ..... 6.495, 4.338  
 Armed\_Auto - ARB ..... 6.74, 4.220  
 Armed\_Auto - CDMA2000 ..... 6.124, 4.561  
 Armed\_Auto - DM ..... 6.198, 4.199  
 Armed\_Auto - GPS ..... 6.227, 4.733  
 Armed\_Auto - GSM/EDGE ..... 6.277, 4.283  
 Armed\_Auto - MCCW ..... 6.306, 4.254  
 Armed\_Auto - TD-SCDMA ..... 6.328  
 Armed\_Auto - WiMAX ..... 6.388, 4.710  
 Armed\_Auto - WLAN ..... 6.460, 4.643  
 Armed\_Retrigger - 3GPP FDD ..... 6.495, 4.338  
 Armed\_Retrigger - ARB ..... 6.74, 4.220  
 Armed\_Retrigger - CDMA2000 ..... 6.124, 4.561  
 Armed\_Retrigger - DM ..... 6.198, 4.199  
 Armed\_Retrigger - GPS ..... 6.227, 4.733  
 Armed\_Retrigger - GSM/EDGE ..... 6.277, 4.283  
 Armed\_Retrigger - MCCW ..... 6.306, 4.254  
 Armed\_Retrigger - TD-SCDMA ..... 6.328  
 Armed\_Retrigger - WiMAX ..... 6.388, 4.710  
 Armed\_Retrigger - WLAN ..... 6.460, 4.643  
 ASCII file import/export - List Mode ..... 4.67  
 ASK Depth - DM ..... 6.188, 4.180  
 Assemblies display ..... 6.16, 6.17, 4.8  
 Asterisk ..... 5.18  
 At Slot - BS - 3GPP FDD ..... 6.541, 4.360  
 At Slot - UE - 3GPP FDD ..... 4.422  
 Attenuation - DM ..... 6.194, 4.197  
 Attenuation - GSM/EDGE ..... 6.261, 4.281  
 Attenuator ..... 6.31, 4.52  
 Attenuator Mode ..... 6.31, 4.52  
 Attenuator Mode - List Mode ..... 6.715, 4.70  
 Attenuator Mode - Sweep ..... 6.740, 4.86  
 AttFixed ..... 9.3  
 Auto - 3GPP FDD ..... 6.495, 4.338  
 Auto - ARB ..... 6.74, 4.220  
 Auto - CDMA2000 ..... 6.124, 4.561  
 Auto - DM ..... 6.198, 4.199  
 Auto - GPS ..... 6.227, 4.733  
 Auto - GSM/EDGE ..... 6.277, 4.283  
 Auto - MCCW ..... 6.306, 4.254  
 Auto - TD-SCDMA ..... 6.328  
 Auto - WiMAX ..... 6.388, 4.710  
 Auto - WLAN ..... 6.460, 4.643

Auto Once - Power Sensors ..... 6.36, 4.61  
 AUX I/O interface ..... 6.29, 6.688, 1.8, 4.17  
 AWGN C/N - Test Case Wizard - 3GPP .....  
 ..... 6.641, 4.507, 4.528, 4.531  
 AWGN E/N - Test Case Wizard - 3GPP ..... 6.642, 4.523  
 AWGN Power Level - Test Case Wizard - 3GPP .....  
 ..... 6.642, 4.508, 4.523, 4.528, 4.531  
 AWGN State - Test Case Wizard - 3GPP .....  
 ..... 6.644, 4.507, 4.523, 4.527

**B**

B x T - 3GPP FDD ..... 6.491, 4.333  
 B x T - CDMA2000 ..... 6.118, 4.556  
 B x T - DM ..... 6.191, 4.183  
 B x T - TD-SCDMA ..... 6.323  
 B x T - WLAN ..... 6.454  
 Base station default values - 3GPP FDD ..... 6.544, 4.329  
 Base station default values - CDMA2000 ..... 6.169, 4.552  
 Base station identification - 3GPP FDD ..... 6.544, 4.354  
 Baseband A Signal Routing -  
 Test Case Wizard - 3GPP ..... 6.653, 4.488  
 Baseband block menu ..... 4.145  
 Baseband Clipping - TD-SCDMA ..... 4.757  
 Baseband filter - 3GPP FDD ..... 6.493, 4.332  
 Baseband filter - CDMA2000 ..... 6.120, 4.555  
 Baseband filter - GSM/EDGE ..... 6.258, 4.278  
 Baseband filter - TD-SCDMA ..... 6.324, 4.756  
 Baseband Filter - TD-SCDMA ..... 4.752  
 Baseband filter - WLAN ..... 6.456  
 Baseband filter EDGE - GSM/EDGE ..... 6.257, 4.279  
 Baseband Gain (I/Q) ..... 6.292, 4.121  
 Baseband Only - DM ..... 6.195, 4.197  
 Baseband Only - GSM ..... 6.273, 4.281  
 Baseband selection ..... 2.3  
 Baseband Trigger Input Slope ..... 6.689, 4.14  
 Basic midamble code ..... 4.743  
 Basic Midamble Code ID - TD-SCDMA ..... 6.342, 4.771  
 BB-AM State ..... 6.41, 4.101  
 BCH Slot - TD-SCDMA ..... 6.360, 4.774  
 BCH Spreading Code Selection - TD-SCDMA ..... 6.359, 4.774  
 Bias - I/Q out ..... 6.695, 6.696, 4.126  
 Binary Channel Bits/TTI (Nbin) - HSUPA FRC -  
 3GPP FDD ..... 6.598, 4.467  
 Bit energy to noise power density ..... 6.47, 4.141  
 Bit Error Insertion - BS1 - CDMA2000 ..... 6.152, 4.595  
 Bit Error Rate - BS1 - CDMA2000 ..... 6.151, 4.595  
 Bit Error Rate - Enhanced DPCHs BS1 - 3GPP FDD .....  
 ..... 6.555, 6.627, 4.390  
 Bit Error Rate - Enhanced DPDCH UE1 - 3GPP FDD ..... 4.477  
 Bit Error Rate - HSDPA H-Set BS1 - 3GPP FDD ..... 6.565  
 Bit Error Rate - HSUPA FRC - 3GPP FDD ..... 6.594, 4.469  
 Bit Error Rate - TD-SCDMA ..... 4.776  
 Bit Error Rate - Test Case Wizard - 3GPP .....  
 ..... 6.663, 4.521, 4.526  
 Bit Error State - Enhanced DPCHs BS1 - 3GPP FDD .....  
 ..... 6.555, 4.390  
 Bit Error State - Enhanced DPDCH UE1 - 3GPP FDD .....  
 ..... 6.627, 4.477  
 Bit Error State - HSDPA H-Set BS1 - 3GPP FDD .....  
 ..... 6.566, 4.377  
 Bit Error State - HSUPA FRC - 3GPP FDD ..... 6.594, 4.468  
 Bit Error State - TD-SCDMA ..... 6.347, 4.776  
 Bit Rate - AWGN ..... 6.44, 4.140  
 Bit reversed - CDMA2000 ..... 6.162, 4.578  
 BITCLK output ..... 1.9, 4.18  
 Bits per Frame (DPDCH) - BS1 - 3GPP FDD ..... 6.549, 4.387  
 Bits per Frame (DPDCH) - UE1 - 3GPP FDD ..... 6.623, 4.474  
 Block data ..... 6.19, 5.17  
 Block data not allowed (-168) ..... 9.4  
 Block Error Insertion - BS1 - CDMA2000 ..... 6.153, 4.595  
 Block Error Rate - BS1 - CDMA2000 ..... 6.152, 4.596

Block Error Rate - Enhanced DPCHs BS1 -  
 3GPP FDD ..... 6.556, 4.391  
 Block Error Rate - Enhanced DPDCH UE1 -  
 3GPP FDD ..... 6.628, 4.478  
 Block Error Rate - HSDPA H-Set - 3GPP FDD ..... 6.566  
 Block Error Rate - HSDPA H-Set BS1 - 3GPP FDD ..... 4.378  
 Block Error Rate - HSUPA FRC - 3GPP FDD ..... 6.594, 4.469  
 Block Error Rate - TD-SCDMA ..... 6.347, 4.777  
 Block Error Rate - Test Case Wizard - 3GPP .....  
 ..... 6.663, 4.521, 4.525  
 Block Error State - Enhanced DPCHs BS1 -  
 3GPP FDD ..... 6.556, 4.391  
 Block Error State - Enhanced DPDCH UE1 -  
 3GPP FDD ..... 6.628, 4.478  
 Block Error State - HSDPA H-Set BS1 - 3GPP FDD ..... 6.566  
 Block Error State - HSUPA FRC - 3GPP FDD ..... 6.595, 4.469  
 Block Error State - TD-SCDMA ..... 6.347, 4.777  
 Block Interleaver - BS - CDMA2000 ..... 6.145, 4.595  
 Blocking Scenario - Test Case Wizard - 3GPP ..... 6.656, 4.512  
 Boolean parameter ..... 5.17  
 Boost - WiMAX ..... 6.417, 4.671, 4.692  
 BS frequency - Test Case Wizard - 3GPP ..... 6.644, 4.497  
 BS power - Test Case Wizard - 3GPP ..... 6.645, 4.498  
 BSID (4 LSBs) - WiMAX ..... 6.421, 6.431, 4.667  
 Burst gate ..... 4.159  
 Burst Index - WiMAX ..... 4.669, 4.690  
 BURST input/output ..... 1.9, 4.18  
 Burst Mode - HSDPA BS - 3GPP FDD ..... 6.527, 4.375  
 Burst Parameters - WiMAX ..... 4.672, 4.693  
 Burst Preamble - WiMAX ..... 6.446, 4.669  
 Burst Type - GSM/EDGE ..... 6.261, 4.293  
 Burst Type - WiMAX ..... 6.419, 6.438  
 BUSY ..... 9.2  
 BUSY LED ..... 1.2  
 BxT - TD-SCDMA ..... 4.757

**C**

Cannel Graph - Downlink - TD-SCDMA ..... 4.783  
 Cannot access hardware (200) ..... 9.11  
 Cannot access the EEPROM (202) ..... 9.11  
 Cannot open file (460) ..... 9.11  
 Cannot read file (462) ..... 9.11  
 Cannot write file (461) ..... 9.11  
 Carrier / Noise Ratio ..... 6.47, 4.140  
 Carrier + Noise Level ..... 6.51, 4.143  
 Carrier + Noise PEP ..... 6.51, 4.143  
 Carrier Delay - ARB MCAR ..... 4.242  
 Carrier Gain - ARB MCAR ..... 4.241  
 Carrier Graph - ARB MCAR ..... 4.242  
 Carrier Graph - MCCW ..... 4.251  
 Carrier Index - ARB MCAR ..... 4.241  
 Carrier level - AWGN ..... 6.49, 4.141  
 Carrier Spacing - ARB MCAR ..... 6.63, 4.237  
 Carrier Spacing - MCCW ..... 6.298, 4.247  
 Carrier Spacing - TD-SCDMA ..... 4.743  
 Carrier Start - ARB MCAR ..... 6.68, 4.240  
 Carrier Start - MCCW ..... 6.304, 4.249  
 Carrier State - ARB MCAR ..... 6.63, 6.69, 4.239, 4.241  
 Carrier State - MCCW ..... 6.297, 6.298, 4.249  
 Carrier Stop - ARB MCAR ..... 6.69, 4.240  
 Carrier Stop - MCCW ..... 6.304, 4.249  
 Carrier Table - MCCW ..... 4.250  
 Carrier Table Assistant - ARB MCAR ..... 6.68, 4.240  
 Carrier Table Assistant - MCCW ..... 6.304, 4.249  
 Carrier Table button- ARB MCAR ..... 4.239  
 CCDF display ..... 4.40  
 CDMA Version ..... 6.135, 6.338, 4.549  
 Cell Default Values - TD-SCDMA ..... 6.328, 4.753  
 Cell State ..... 4.755  
 Center Freq ..... 6.682, 4.82  
 Channel Coding - CDMA2000 ..... 4.534

Channel Coding - TD-SCDMA .....	6.355, 6.360, 4.773, 4.774, 4.775
Channel Coding - UE1 - 3GPP FDD .....	4.471
Channel Coding - WiMAX .....	6.431, 4.669
Channel Coding FEC - WiMAX .....	6.409
Channel Coding Interleaver - WiMAX .....	6.409
Channel Coding Mode - BS - CDMA2000 .....	6.147, 4.592
Channel Coding Mode - MS - CDMA2000 .....	6.175, 4.605
Channel Coding Mode - WiMAX .....	6.410, 4.691
Channel Coding Randomizer - WiMAX .....	6.410, 4.699, 4.700
Channel Coding Repetition Coding - WiMAX .....	6.410
Channel Coding State - BS1 - 3GPP FDD .....	6.551, 4.384
Channel Coding State - UE1 - 3GPP FDD .....	6.624
Channel Coding State Enhanced P-CCPCH - BS1 - 3GPP FDD .....	6.567, 4.381
Channel Coding Type P-CCPCH - BS1 - 3GPP FDD .....	6.567, 4.381
Channel Graph - BS - 3GPP FDD .....	4.365
Channel Graph - BS - CDMA2000 .....	4.579
Channel Number - BS - 3GPP FDD .....	4.366
Channel Number - BS - CDMA2000 .....	4.581
Channel Number - TD-SCDMA .....	4.783
Channel Number DPDCH - UE - 3GPP FDD .....	4.458
Channel Number E-DPDCH - UE - 3GPP FDD .....	4.464
Channel Number-MS - CDMA2000 .....	4.608
Channel P-CCPCH - BS - 3GPP FDD .....	4.379
Channel Power - BS - 3GPP FDD .....	6.536, 4.370
Channel Power - BS - CDMA2000 .....	6.154, 4.585
Channel Power - MS - CDMA2000 .....	6.178, 4.610
Channel Power - Multichannel BS - 3GPP FDD .....	4.411
Channel Power - TD-SCDMA .....	6.369, 4.785
Channel Power DPDCH - UE - 3GPP FDD .....	6.582, 4.455
Channel Power HS-DPCCH - UE - 3GPP FDD .....	6.586, 4.451
Channel State - BS - 3GPP FDD .....	6.537, 4.372
Channel State - BS - CDMA2000 .....	6.155, 4.586
Channel State - MS - CDMA2000 .....	6.179, 4.611
Channel State - TD-SCDMA .....	6.371, 4.786
Channel Table DPDCH - UE - 3GPP FDD .....	4.456, 4.463, 4.464
Channel Table DPDCH - UE - 3GPP FDD .....	4.454, 4.458
Channel Table E-DPDCH - UE - 3GPP FDD .....	4.461, 4.464
Channel Type - BS - 3GPP FDD .....	6.538, 4.366
Channel Type - BS - CDMA2000 .....	6.160
Channel Type - DPDCH UE - 3GPP FDD .....	4.458
Channel Type - E-DPDCH UE - 3GPP FDD .....	4.464
Channel Type - MS - CDMA2000 .....	6.179, 4.608
Channel Type - Multichannel BS - 3GPP FDD .....	4.409
Channel Type - TD-SCDMA .....	6.371, 4.783
Channel types - 3GPP FDD .....	4.311
Channel types - CDMA2000 .....	4.534
Channel types - TD-SCDMA .....	4.743
Channel x - ARB .....	4.223
Channelization code - 3GPP FDD .....	4.311
Channelization Code - BS - 3GPP FDD .....	6.516, 4.369
Channelization Code - Multichannel BS - 3GPP FDD .....	4.410
Channelization Code DPCCH - UE - 3GPP FDD .....	6.583, 4.443
Channelization Code DPDCH - UE - 3GPP FDD .....	6.575, 4.458
Channelization Code E-DPCCH - UE - 3GPP FDD .....	4.448
Channelization Code E-DPDCH - UE - 3GPP FDD .....	6.598, 4.465
Channelization Code Offset - 3GPP FDD .....	6.489, 4.330
Channelization Code Step - Multichannel BS - 3GPP FDD .....	4.410
Character data .....	5.15
Character data not allowed (-148) .....	9.4
Character data too long (-144) .....	9.4
Characters, special .....	6.1
Check Front Panel .....	4.12
Check-box field .....	3.14
Chip clock - 3GPP FDD .....	4.345
Chip clock - CDMA2000 .....	4.567
Chip clock - GPS .....	6.222, 4.740
Chip clock - WLAN .....	4.649
Chip Clock Mode - TD-SCDMA .....	4.767
Chip Clock Multiplier - 3GPP FDD .....	6.488, 4.345
Chip Clock Multiplier - CDMA2000 .....	6.113, 4.567
Chip Clock Multiplier - GPS .....	6.222, 4.740
Chip Clock Multiplier - TD-SCDMA .....	6.320, 4.768
Chip Clock Multiplier - WLAN .....	6.452, 4.650
Chip rate - 3GPP FDD .....	4.311
Chip Rate - 3GPP FDD .....	6.490, 4.324
Chip Rate - TD-SCDMA .....	6.322, 4.743, 4.751
Chip Rate Variation - 3GPP FDD .....	6.491, 4.333
Chip Rate Variation - CDMA2000 .....	6.117, 4.556
Chip Rate Variation - TD-SCDMA .....	6.323, 4.757
Chip Sequence Period Marker - TD-SCDMA .....	4.765
Clipping - TD-SCDMA .....	4.752, 4.757
Clipping Level - 3GPP FDD .....	6.486, 4.335
Clipping Level - CDMA2000 .....	6.112, 4.557
Clipping Level - TD-SCDMA .....	4.759
Clipping Level - WLAN .....	6.451
Clipping Mode - 3GPP FDD .....	6.486, 4.335
Clipping Mode - CDMA2000 .....	6.112, 4.558
Clipping Mode - TD-SCDMA .....	6.319, 4.759
Clipping Mode - WLAN .....	6.451
Clock Divider - GSM/EDGE .....	6.255, 4.291
Clock Frequency - ARB .....	6.58, 4.212
Clock input .....	1.6
Clock input slope .....	6.14, 4.15
Clock Mode - 3GPP FDD .....	6.487, 4.345
Clock Mode - ARB .....	6.59, 4.226
Clock Mode - CDMA2000 .....	6.113, 4.567
Clock Mode - DM .....	6.189, 4.204
Clock Mode - GPS .....	6.222, 4.740
Clock Mode - GSM/EDGE .....	6.256, 4.290
Clock Mode - MCCW .....	6.300, 4.259
Clock Mode - TD-SCDMA .....	6.320, 4.767
Clock Mode - WiMAX .....	6.381, 4.716
Clock Mode - WLAN .....	6.452, 4.649
Clock Multiplier - ARB .....	6.59, 4.226
Clock Multiplier - DM .....	6.189, 4.205
Clock Multiplier - GSM/EDGE .....	6.256, 4.291
Clock Multiplier - MCCW .....	6.301, 4.259
Clock out mode .....	6.14, 4.15
Clock out source .....	6.15, 4.15
Clock output .....	1.6
Clock parameters - 3GPP FDD .....	4.325
Clock rate - ARB .....	4.212
Clock rate - ARB MCAR .....	6.65
Clock rate mode - ARB .....	6.93, 4.230
Clock Reference .....	4.154
Clock Source - 3GPP FDD .....	6.488, 4.344
Clock Source - ARB .....	6.60, 4.225
Clock Source - CDMA2000 .....	6.114, 4.566
Clock Source - DM .....	6.190, 4.204
Clock Source - GPS .....	6.223, 4.739
Clock Source - GSM/EDGE .....	6.257, 4.289
Clock Source - MCCW .....	6.301, 4.259
Clock Source - TD-SCDMA .....	6.321, 4.767
Clock Source - WiMAX .....	6.382, 4.716
Clock Source - WLAN .....	6.453, 4.649
CLOCK tag .....	6.101
Clock Trigger Delay - GSM/EDGE .....	4.286
Clock Trigger Inhibity - GSM/EDGE .....	6.280, 4.286
Clock-Parameter - ARB .....	4.225
Code Domain - CDMA2000 .....	4.577
Code Domain Conflict .....	4.363, 4.419
Code Domain Conflict - BS - 3GPP FDD .....	4.372
Code Domain Conflict - BS - CDMA2000 .....	6.163, 4.578, 4.586
Code Domain Graph - BS - CDMA2000 .....	4.575
Code Domain Graph - Downlink - TD-SCDMA .....	4.783
Code Domain ideal display .....	4.363, 4.419
Code tree of channelization codes .....	4.362



Coder Type - BS - CDMA2000 .....	6.148, 4.594	OUTPut:BLANk:POLarity .....	6.31
Coding - DM .....	6.190, 4.179	READ<[1]...3>[:POWer]? .....	6.35
Coding Rate (Nint/Nbin) - HSUPA FRC - 3GPP FDD .....	6.593, 4.467	SENSe<[1]...3>[:POWer]:FILTer:LENGth .....	6.36
Coding Scheme - TD-SCDMA .....	4.774, 4.775	SENSe<[1]...3>[:POWer]:FILTer:SONCe .....	6.36
Coding State PCPCH - UE - 3GPP FDD .....	6.637, 4.441	SENSe<[1]...3>[:POWer]:FILTer:TYPE .....	6.36
Coding State PRACH - UE - 3GPP FDD .....	6.638, 4.431	SENSe<[1]...3>[:POWer]:FREQuency .....	6.37
Coding Type - BS1 - 3GPP FDD .....	6.552, 4.384	SENSe<[1]...3>[:POWer]:SNUMber .....	6.37
Coding Type - TD-SCDMA .....	4.774, 4.775	SENSe<[1]...3>[:POWer]:SOURce .....	6.37
Coding Type Enhanced DPDCH - UE1 - 3GPP FDD .....	6.624, 4.472	SENSe<[1]...3>[:POWer]:STATus[:DEVice]? .....	6.38
Coding Type PCPCH - UE1 - 3GPP FDD .....	6.638, 4.442	SENSe<[1]...3>[:POWer]:TYPE? .....	6.38
Coding Type PRACH - UE - 3GPP FDD .....	6.638, 4.431	SENSe<[1]...3>[:POWer]:ZERO .....	6.38
Colon (separator) .....	5.18	SENSe<[1]...3>:UNIT[:POWer] .....	6.39
Column Separator Import/Export - List Mode data .....	6.709	[SOURce<[1]2>:]AM[:DEPT] .....	6.41
Column Separator Import/Export - User Correction data .....	6.674, 4.66	[SOURce<[1]2>:]AM:EXTerMal:COUPling .....	6.42
Comma (separator) .....	5.18	[SOURce<[1]2>:]AM:SENSitivity .....	6.42
Command .....	5.30	[SOURce<[1]2>:]AM:SOURce .....	6.42
addressed .....	5.30	[SOURce<[1]2>:]AM:STATE .....	6.43
description .....	6.1	[SOURce<[1]2>:]AWGN:BRATe .....	6.44
header .....	5.12	[SOURce<[1]2>:]AWGN:BWIDth .....	6.45
Line .....	5.15	[SOURce<[1]2>:]AWGN:BWIDth:NOISe .....	6.45
parameters .....	5.16	[SOURce<[1]2>:]AWGN:BWIDth^RATio .....	6.45
query .....	5.15	[SOURce<[1]2>:]AWGN:CNRatio .....	6.47
question mark .....	5.15	[SOURce<[1]2>:]AWGN:ENRatio .....	6.47
sequence .....	5.21	[SOURce<[1]2>:]AWGN:FREQuency:RESulting .....	6.48
structure .....	5.12	[SOURce<[1]2>:]AWGN:FREQuency:TARGet .....	6.48
suffix .....	5.14	[SOURce<[1]2>:]AWGN:MODE .....	6.48
synchronization .....	5.21	[SOURce<[1]2>:]AWGN:POWer:CARRier .....	6.49
universal .....	5.30	[SOURce<[1]2>:]AWGN:POWer:MODE .....	6.49
Command Error (-100) .....	9.4	[SOURce<[1]2>:]AWGN:POWer:NOISe .....	6.50
Command protected (-203) .....	9.4	[SOURce<[1]2>:]AWGN:POWer:NOISe:TOTal? .....	6.50
Commands .....		[SOURce<[1]2>:]AWGN:POWer:RMODE .....	6.51
CALibration<[1]2>:FREQuency[:MEASure]? .....	6.11	[SOURce<[1]2>:]AWGN:POWer:SUM? .....	6.51
CALibration<[1]2>:IQModulation:LOCAl? .....	6.11	[SOURce<[1]2>:]AWGN:POWer:SUM:PEP? .....	6.51
CALibration<[1]2>:IQModulator:FULL? .....	6.11	[SOURce<[1]2>:]AWGN:STATE .....	6.52
CALibration<[1]2>:LEVel[:MEASure]? .....	6.13	[SOURce<[1]2>:]BB:ARB:CLOCK .....	6.58
CALibration<[1]2>:LEVel:STATE .....	6.13	[SOURce<[1]2>:]BB:ARB:CLOCK:MODE .....	6.59
CALibration:ALL[:MEASure]? .....	6.10	[SOURce<[1]2>:]BB:ARB:CLOCK:MULTiplier .....	6.59
CLOCK:INPut:FREQuency .....	6.14	[SOURce<[1]2>:]BB:ARB:CLOCK:SOURce .....	6.60
CLOCK:INPut:SLOPe .....	6.14	[SOURce<[1]2>:]BB:ARB:MCARRier:	
CLOCK:OUTPut:MODE? .....	6.14	CARRier<0...31>:DELay .....	6.60
CLOCK:OUTPut:SOURce? .....	6.15	[SOURce<[1]2>:]BB:ARB:MCARRier:	
DEVice:PRESet .....	6.8	CARRier<0...31>:FILE .....	6.62
DIAGnostic[:MEASure]:POINT? .....	6.18	[SOURce<[1]2>:]BB:ARB:MCARRier:	
DIAGnostic<[1]2>:BGInfo? .....	6.16	CARRier<0...31>:POWer .....	6.62
DIAGnostic<[1]2>:BGInfo:CATalog? .....	6.17	[SOURce<[1]2>:]BB:ARB:MCARRier:	
DIAGnostic<[1]2>:POINT:CATalog? .....	6.18	CARRier<0...31>:STATE .....	6.63
DIAGnostic:INFO:OTIME? .....	6.17	[SOURce<[1]2>:]BB:ARB:MCARRier:CARRier:	
DIAGnostic:INFO:PCOunter? .....	6.17	COUNT .....	6.60
MMEMory:CATalog? .....	6.23	[SOURce<[1]2>:]BB:ARB:MCARRier:CARRier:	
MMEMory:CATalog:LENGth? .....	6.24	SPACing .....	6.63
MMEMory:CDIRectory .....	6.24	[SOURce<[1]2>:]BB:ARB:MCARRier:CFACtor:	
MMEMory:COPI .....	6.24	MODE .....	6.64
MMEMory:DATA .....	6.25	[SOURce<[1]2>:]BB:ARB:MCARRier:CLOAd .....	6.64
MMEMory:DCATalog? .....	6.25	[SOURce<[1]2>:]BB:ARB:MCARRier:CLOCK .....	6.65
MMEMory:DCATalog:LENGth? .....	6.26	[SOURce<[1]2>:]BB:ARB:MCARRier:CREate .....	6.65
MMEMory:DELeTe .....	6.26	[SOURce<[1]2>:]BB:ARB:MCARRier:EDIT:CARRier:	
MMEMory:LOAD:STATE .....	6.26	DELay[:STARt] .....	6.65
MMEMory:MDIRectory .....	6.27	[SOURce<[1]2>:]BB:ARB:MCARRier:EDIT:CARRier:	
MMEMory:MOVE .....	6.27	DELay:STEP .....	6.66
MMEMory:MSIS .....	6.27	[SOURce<[1]2>:]BB:ARB:MCARRier:EDIT:CARRier:	
MMEMory:RDIRectory .....	6.28	EXECute .....	6.66
MMEMory:STORe:STATE .....	6.28	[SOURce<[1]2>:]BB:ARB:MCARRier:EDIT:CARRier:	
OUTPut<[1]2>[:STATE] .....	6.33	FILE .....	6.66
OUTPut<[1]2>[:STATE]:PON .....	6.33	[SOURce<[1]2>:]BB:ARB:MCARRier:EDIT:CARRier:	
OUTPut<[1]2>:AFIXed:RANGe:LOWer? .....	6.30	PHASef[:STARt] .....	6.67
OUTPut<[1]2>:AFIXed:RANGe:UPPer? .....	6.30	[SOURce<[1]2>:]BB:ARB:MCARRier:EDIT:CARRier:	
OUTPut<[1]2>:ALL[:STATE] .....	6.29	PHASe:STEP .....	6.67
OUTPut<[1]2>:AMODE .....	6.31	[SOURce<[1]2>:]BB:ARB:MCARRier:EDIT:CARRier:	
OUTPut<[1]2>:IMPedance .....	6.33	POWer[:STARt] .....	6.68
OUTPut<[1]2>:USER<1...4>:SOURce .....	6.34	[SOURce<[1]2>:]BB:ARB:MCARRier:EDIT:CARRier:	
		POWer:STEP .....	6.68

[SOURce<[1]2>:]BB:ARB:MCARrier:EDIT:CARRier:  
 START ..... 6.68  
 [SOURce<[1]2>:]BB:ARB:MCARrier:EDIT:CARRier:  
 STATE ..... 6.69  
 [SOURce<[1]2>:]BB:ARB:MCARrier:EDIT:CARRier:  
 STOP ..... 6.69  
 [SOURce<[1]2>:]BB:ARB:MCARrier:OFILe ..... 6.69  
 [SOURce<[1]2>:]BB:ARB:MCARrier:PRESet ..... 6.69  
 [SOURce<[1]2>:]BB:ARB:MCARrier:SAMPles ..... 6.70  
 [SOURce<[1]2>:]BB:ARB:MCARrier:SETTing:  
 CATalog? ..... 6.71  
 [SOURce<[1]2>:]BB:ARB:MCARrier:SETTing:LOAD ..... 6.71  
 [SOURce<[1]2>:]BB:ARB:MCARrier:SETTing:  
 STORE ..... 6.71  
 [SOURce<[1]2>:]BB:ARB:MCARrier:TIME ..... 6.72  
 [SOURce<[1]2>:]BB:ARB:MCARrier:TIME:MODE ..... 6.72  
 [SOURce<[1]2>:]BB:ARB:PRESet ..... 6.73  
 [SOURce<[1]2>:]BB:ARB:SEQuence ..... 6.74  
 [SOURce<[1]2>:]BB:ARB:STATe ..... 6.74  
 [SOURce<[1]2>:]BB:ARB:TRIGger  
 [:EXTernal<[1]2>:]DELAy ..... 6.76  
 [SOURce<[1]2>:]BB:ARB:TRIGger  
 [:EXTernal<[1]2>:]INHibit ..... 6.76  
 [SOURce<[1]2>:]BB:ARB:TRIGger:ARM:EXECute ..... 6.75  
 [SOURce<[1]2>:]BB:ARB:TRIGger:EXECute ..... 6.75  
 [SOURce<[1]2>:]BB:ARB:TRIGger:OBASeband:  
 DELAy ..... 6.76  
 [SOURce<[1]2>:]BB:ARB:TRIGger:OBASeband:  
 INHibit ..... 6.78  
 [SOURce<[1]2>:]BB:ARB:TRIGger:OUTPut<[1]...4>:  
 DELAy ..... 6.78  
 [SOURce<[1]2>:]BB:ARB:TRIGger:OUTPut<[1]...4>:  
 DELAy:MAXimum? ..... 6.80  
 [SOURce<[1]2>:]BB:ARB:TRIGger:OUTPut<[1]...4>:  
 DELAy:MINimum? ..... 6.80  
 [SOURce<[1]2>:]BB:ARB:TRIGger:OUTPut<[1]...4>:  
 MODE ..... 6.81  
 [SOURce<[1]2>:]BB:ARB:TRIGger:OUTPut<[1]...4>:  
 OFFTime ..... 6.82  
 [SOURce<[1]2>:]BB:ARB:TRIGger:OUTPut<[1]...4>:  
 ONTime ..... 6.82  
 [SOURce<[1]2>:]BB:ARB:TRIGger:OUTPut<[1]...4>:  
 PATTern ..... 6.82  
 [SOURce<[1]2>:]BB:ARB:TRIGger:OUTPut<[1]...4>:  
 PULSe:DIVider ..... 6.83  
 [SOURce<[1]2>:]BB:ARB:TRIGger:OUTPut<[1]...4>:  
 PULSe:FREQuency? ..... 6.83  
 [SOURce<[1]2>:]BB:ARB:TRIGger:OUTPut:DELAy:  
 FIXed ..... 6.78  
 [SOURce<[1]2>:]BB:ARB:TRIGger:RMODE? ..... 6.84  
 [SOURce<[1]2>:]BB:ARB:TRIGger:SLENgth ..... 6.84  
 [SOURce<[1]2>:]BB:ARB:TRIGger:SLUNit ..... 6.85  
 [SOURce<[1]2>:]BB:ARB:TRIGger:SMODE ..... 6.85  
 [SOURce<[1]2>:]BB:ARB:TRIGger:SOURce ..... 6.86  
 [SOURce<[1]2>:]BB:ARB:TSIGNal:SINE:  
 FREQuency ..... 6.86  
 [SOURce<[1]2>:]BB:ARB:TSIGNal:SINE:PHASe ..... 6.86  
 [SOURce<[1]2>:]BB:ARB:TSIGNal:SINE:SAMPles ..... 6.87  
 [SOURce<[1]2>:]BB:ARB:WAVeform:CATalog? ..... 6.87  
 [SOURce<[1]2>:]BB:ARB:WAVeform:CATalog:  
 LENGth? ..... 6.88  
 [SOURce<[1]2>:]BB:ARB:WAVeform:DATA ..... 6.88  
 [SOURce<[1]2>:]BB:ARB:WAVeform:DELeTe ..... 6.90  
 [SOURce<[1]2>:]BB:ARB:WAVeform:FREE ..... 6.90  
 [SOURce<[1]2>:]BB:ARB:WAVeform:POINts ..... 6.90  
 [SOURce<[1]2>:]BB:ARB:WAVeform:SELeCt ..... 6.91  
 [SOURce<[1]2>:]BB:ARB:WAVeform:TAg? ..... 6.91  
 [SOURce<[1]2>:]BB:ARB:WSEGment ..... 6.91  
 [SOURce<[1]2>:]BB:ARB:WSEGment:CLoAd ..... 6.92  
 [SOURce<[1]2>:]BB:ARB:WSEGment:CONFigure:  
 CATalog? ..... 6.92  
 [SOURce<[1]2>:]BB:ARB:WSEGment:CONFigure:  
 CLoCK ..... 6.93

[SOURce<[1]2>:]BB:ARB:WSEGment:CONFigure:  
 CLoCK:MODE ..... 6.93  
 [SOURce<[1]2>:]BB:ARB:WSEGment:CONFigure:  
 CoMMent ..... 6.94  
 [SOURce<[1]2>:]BB:ARB:WSEGment:CONFigure:  
 DELeTe ..... 6.94  
 [SOURce<[1]2>:]BB:ARB:WSEGment:CONFigure:  
 LEVell:MODE] ..... 6.94  
 [SOURce<[1]2>:]BB:ARB:WSEGment:CONFigure:  
 OFILe ..... 6.96  
 [SOURce<[1]2>:]BB:ARB:WSEGment:CONFigure:  
 SEGment:APPend ..... 6.96  
 [SOURce<[1]2>:]BB:ARB:WSEGment:CONFigure:  
 SEGment:CATalog? ..... 6.97  
 [SOURce<[1]2>:]BB:ARB:WSEGment:CONFigure:  
 SELeCt ..... 6.97  
 [SOURce<[1]2>:]BB:ARB:WSEGment:CREate ..... 6.98  
 [SOURce<[1]2>:]BB:ARB:WSEGment:NEXt ..... 6.98  
 [SOURce<[1]2>:]BB:C2K:BSTation[1]:  
 CGRoup<0[1]>:COFFset<[1]...7>:DERRor:BLoCK:  
 RATE ..... 6.152  
 [SOURce<[1]2>:]BB:C2K:BSTation[1]:  
 CGRoup<0[1]>:COFFset<[1]...7>:DERRor:BLoCK:  
 STATe ..... 6.153  
 [SOURce<[1]2>:]BB:C2K:BSTation<[1]2[3]4>:  
 CGRoup<[1]...8>:COFFset<[1]4>:TPC:DATA ..... 6.156  
 [SOURce<[1]2>:]BB:C2K:BSTation<[1]2[3]4>:  
 CGRoup<[1]...8>:COFFset<[1]4>:TPC:DATA:  
 DSELeCt ..... 6.157  
 [SOURce<[1]2>:]BB:C2K:BSTation<[1]2[3]4>:  
 CGRoup<[1]...8>:COFFset<[1]4>:TPC:DATA:  
 PATTern ..... 6.157  
 [SOURce<[1]2>:]BB:C2K:BSTation<[1]2[3]4>:  
 CGRoup<0[1]...8>:COFFset<[1]...11>:FLENgth ..... 6.153  
 [SOURce<[1]2>:]BB:C2K:BSTation<[1]2[3]4>:  
 CGRoup<0[1]...8>:COFFset<[1]...13>:DATA ..... 6.149  
 [SOURce<[1]2>:]BB:C2K:BSTation<[1]2[3]4>:  
 CGRoup<0[1]...8>:COFFset<[1]...13>:DATA:  
 DSELeCt ..... 6.150  
 [SOURce<[1]2>:]BB:C2K:BSTation<[1]2[3]4>:  
 CGRoup<0[1]...8>:COFFset<[1]...13>:DATA:  
 PATTern ..... 6.150  
 [SOURce<[1]2>:]BB:C2K:BSTation<[1]2[3]4>:  
 CGRoup<0[1]...8>:COFFset<[1]...13>:DATA:RATE ..... 6.151  
 [SOURce<[1]2>:]BB:C2K:BSTation<[1]2[3]4>:  
 CGRoup<0[1]...8>:COFFset<[1]...13>:POWer ..... 6.154  
 [SOURce<[1]2>:]BB:C2K:BSTation<[1]2[3]4>:  
 CGRoup<0[1]...8>:COFFset<[1]...13>:QWCode:  
 STATe ..... 6.155  
 [SOURce<[1]2>:]BB:C2K:BSTation<[1]2[3]4>:  
 CGRoup<0[1]...8>:COFFset<[1]...13>:WCoDE ..... 6.161  
 [SOURce<[1]2>:]BB:C2K:BSTation<[1]2[3]4>:  
 CGRoup<0[1]...8>:COFFset<[1]...13>:WLENgth ..... 6.161  
 [SOURce<[1]2>:]BB:C2K:BSTation<[1]2[3]4>:  
 CGRoup<0[1]...8>:COFFset<[1]...14>:STATe ..... 6.155  
 [SOURce<[1]2>:]BB:C2K:BSTation<[1]2[3]4>:  
 CGRoup<0[1]...8>:COFFset<[1]...14>:TYPE ..... 6.160  
 [SOURce<[1]2>:]BB:C2K:BSTation<[1]2[3]4>:  
 CGRoup<0[1]...7>:REALTime:  
 STATe ..... 6.155  
 [SOURce<[1]2>:]BB:C2K:BSTation<[1]2[3]4>:  
 DCONflict:STATe? ..... 6.163  
 [SOURce<[1]2>:]BB:C2K:BSTation<[1]2[3]4>:  
 DCONflict:MODE ..... 6.162  
 [SOURce<[1]2>:]BB:C2K:BSTation<[1]2[3]4>:  
 DCONflict:RESolve ..... 6.162  
 [SOURce<[1]2>:]BB:C2K:BSTation<[1]2[3]4>:  
 PNOFFset ..... 6.169  
 [SOURce<[1]2>:]BB:C2K:BSTation<[1]2[3]4>:  
 CGRoup<[1]...8>:COFFset<[1]...11>:LCMAsk ..... 6.154  
 [SOURce<[1]2>:]BB:C2K:BSTation<[1]2[3]4>:  
 CGRoup<[1]...8>:COFFset<[1]...13>:CCoDing:  
 BINTerleaver ..... 6.145

[SOURce<[1]2>:JBB:C2K:BSTation<[1]2 3 4>: CGRoup<[1]...8>:COFFset<[1]4>:TPC:MISuse	6.158	[SOURce<[1]2>:JBB:C2K:FILTer:PARAmeter: APCO25	6.118
[SOURce<[1]2>:JBB:C2K:BSTation<[1]2 3 4>: CGRoup<[1]...8>:COFFset<[1]4>:TPC:PSTep	6.158	[SOURce<[1]2>:JBB:C2K:FILTer:PARAmeter: COSine	6.118
[SOURce<[1]2>:JBB:C2K:BSTation<[1]2 3 4>: CGRoup<[1]...8>:COFFset<[1]4>:TPC:READ	6.159	[SOURce<[1]2>:JBB:C2K:FILTer:PARAmeter: GAUSSs	6.118
[SOURce<[1]2>:JBB:C2K:BSTation<[1]2 3 4>: CGRoup<[1]...8>:RCONfiguration	6.161	[SOURce<[1]2>:JBB:C2K:FILTer:PARAmeter: PGAuss	6.119
[SOURce<[1]2>:JBB:C2K:BSTation<[1]2 3 4>: CGRoup<0 [1]...8>:COFFset<[1]...13>:CCODing: BITFrame	6.145	[SOURce<[1]2>:JBB:C2K:FILTer:PARAmeter: RCOSine	6.119
[SOURce<[1]2>:JBB:C2K:BSTation<[1]2 3 4>: CGRoup<0 [1]...8>:COFFset<[1]...13>:CCODing: CRC	6.146	[SOURce<[1]2>:JBB:C2K:FILTer:PARAmeter: SPHase	6.119
[SOURce<[1]2>:JBB:C2K:BSTation<[1]2 3 4>: CGRoup<0 [1]...8>:COFFset<[1]...13>:CCODing: DATA:RATE	6.146	[SOURce<[1]2>:JBB:C2K:FILTer:TYPE	6.120
[SOURce<[1]2>:JBB:C2K:BSTation<[1]2 3 4>: CGRoup<0 [1]...8>:COFFset<[1]...13>:CCODing: MODE	6.147	[SOURce<[1]2>:JBB:C2K:IQSWap:STATE	6.121
[SOURce<[1]2>:JBB:C2K:BSTation<[1]2 3 4>: CGRoup<0 [1]...8>:COFFset<[1]...13>:CCODing: SPUNcture	6.147	[SOURce<[1]2>:JBB:C2K:LINK	6.121
[SOURce<[1]2>:JBB:C2K:BSTation<[1]2 3 4>: CGRoup<0 [1]...8>:COFFset<[1]...13>:CCODing: SREPetition	6.148	[SOURce<[1]2>:JBB:C2K:MSTation<[1]2 3 4>]: CHANnel<[1]...5>:WCODe	6.180
[SOURce<[1]2>:JBB:C2K:BSTation<[1]2 3 4>: CGRoup<0 [1]...8>:COFFset<[1]...13>:CCODing: TYPE	6.148	[SOURce<[1]2>:JBB:C2K:MSTation<[1]2 3 4>]: CHANnel<[1]...8>:DATA:RATE	6.177
[SOURce<[1]2>:JBB:C2K:BSTation<[1]2 3 4>: PDCH:PINterval	6.163	[SOURce<[1]2>:JBB:C2K:MSTation<[1]2 3 4>]: CHANnel<[1]...8>:FLEngth	6.178
[SOURce<[1]2>:JBB:C2K:BSTation<[1]2 3 4>: PDCH:PSETup	6.164	[SOURce<[1]2>:JBB:C2K:MSTation<[1]2 3 4>]: CHANnel<[1]...8>:POWER	6.178
[SOURce<[1]2>:JBB:C2K:BSTation<[1]2 3 4>: PDCH:SUBPacket<[1]...8>:ID	6.164	[SOURce<[1]2>:JBB:C2K:MSTation<[1]2 3 4>]: CHANnel<[1]...8>:SPRead?	6.178
[SOURce<[1]2>:JBB:C2K:BSTation<[1]2 3 4>: PDCH:SUBPacket<[1]...8>:PARAMeters	6.164	[SOURce<[1]2>:JBB:C2K:MSTation<[1]2 3 4>]: CHANnel<[1]...8>:STATE	6.179
[SOURce<[1]2>:JBB:C2K:BSTation<[1]2 3 4>: PDCH:SUBPacket<[1]...8>:RESulting:WCODes	6.168	[SOURce<[1]2>:JBB:C2K:MSTation<[1]2 3 4>]: CHANnel<[1]...8>:TYPE	6.179
[SOURce<[1]2>:JBB:C2K:BSTation<[1]2 3 4>: PDCH:SUBPacket<[1]...8>:STATE	6.168	[SOURce<[1]2>:JBB:C2K:MSTation<[1]2 3 4>]: TPC:DATA	6.183
[SOURce<[1]2>:JBB:C2K:BSTation<[1]2 3 4>:PDCH: SUBPacket<[1]...8>:TOFFset	6.168	[SOURce<[1]2>:JBB:C2K:MSTation<[1]2 3 4>]: TPC:DATA:DSElect	6.183
[SOURce<[1]2>:JBB:C2K:BSTation<[1]2 3 4>: PDCH:WINDex	6.169	[SOURce<[1]2>:JBB:C2K:MSTation<[1]2 3 4>]: TPC:DATA:PATtern	6.184
[SOURce<[1]2>:JBB:C2K:BSTation<[1]2 3 4>: QWSet	6.170	[SOURce<[1]2>:JBB:C2K:MSTation<[1]2 3 4>: CHANnel<[1]...8>:DPDCh:DATA	6.176
[SOURce<[1]2>:JBB:C2K:BSTation<[1]2 3 4>: STATE	6.170	[SOURce<[1]2>:JBB:C2K:MSTation<[1]2 3 4>: CHANnel<[1]...8>:DSElectt	6.176
[SOURce<[1]2>:JBB:C2K:BSTation<[1]2 3 4>: TDIVersity	6.171	[SOURce<[1]2>:JBB:C2K:MSTation<[1]2 3 4>: CHANnel<[1]...8>:PATtern	6.177
[SOURce<[1]2>:JBB:C2K:BSTation<[1]2 3 4>: TDIVersity:MODE	6.171	[SOURce<[1]2>:JBB:C2K:MSTation<[1]2 3 4>: LCMask	6.180
[SOURce<[1]2>:JBB:C2K:BSTation<2 3 4>: TDElay:STEP	6.170	[SOURce<[1]2>:JBB:C2K:MSTation<[1]2 3 4>: MODE	6.181
[SOURce<[1]2>:JBB:C2K:BSTation:CGRoup<0 [1]2>: COFFset<[1]...7>:DERRor:BIT:RATE	6.151	[SOURce<[1]2>:JBB:C2K:MSTation<[1]2 3 4>: RCONfiguration	6.182
[SOURce<[1]2>:JBB:C2K:BSTation:CGRoup<0 [1]2>: COFFset<[1]...7>:DERRor:BIT:STATE	6.152	[SOURce<[1]2>:JBB:C2K:MSTation<[1]2 3 4>: STATE	6.182
[SOURce<[1]2>:JBB:C2K:BSTation:PRESet	6.169	[SOURce<[1]2>:JBB:C2K:MSTation<[1]2 3 4>:TPC: MISuse	6.184
[SOURce<[1]2>:JBB:C2K:CLIPping:LEVel	6.112	[SOURce<[1]2>:JBB:C2K:MSTation<[1]2 3 4>:TPC: PSTep	6.184
[SOURce<[1]2>:JBB:C2K:CLIPping:MODE	6.112	[SOURce<[1]2>:JBB:C2K:MSTation<[1]2 3 4>:TPC: READ	6.185
[SOURce<[1]2>:JBB:C2K:CLIPping:STATE	6.113	[SOURce<[1]2>:JBB:C2K:MSTation::CCODing: MODE	6.175
[SOURce<[1]2>:JBB:C2K:CLOCK:MODE	6.113	[SOURce<[1]2>:JBB:C2K:MSTation:ADDITIONal: COUNT	6.173
[SOURce<[1]2>:JBB:C2K:CLOCK:MULTiplier	6.113	[SOURce<[1]2>:JBB:C2K:MSTation:ADDITIONal: LCMask:STEP	6.174
[SOURce<[1]2>:JBB:C2K:CLOCK:SOURce	6.114	[SOURce<[1]2>:JBB:C2K:MSTation:ADDITIONal: POWER:OFFSet	6.174
[SOURce<[1]2>:JBB:C2K:COPY:COFFset	6.114	[SOURce<[1]2>:JBB:C2K:MSTation:ADDITIONal: STATE	6.174
[SOURce<[1]2>:JBB:C2K:COPY:DESTination	6.116	[SOURce<[1]2>:JBB:C2K:MSTation:ADDITIONal: TDElay:STEP	6.175
[SOURce<[1]2>:JBB:C2K:COPY:EXECute	6.116	[SOURce<[1]2>:JBB:C2K:MSTation:PRESet	6.181
[SOURce<[1]2>:JBB:C2K:COPY:SOURce	6.117	[SOURce<[1]2>:JBB:C2K:POWER:TOTal]	6.121
[SOURce<[1]2>:JBB:C2K:CRATe?	6.117	[SOURce<[1]2>:JBB:C2K:POWER:ADJust	6.123
[SOURce<[1]2>:JBB:C2K:CRATe:VARiation	6.117	[SOURce<[1]2>:JBB:C2K:PPARAmeter:CRESt	6.137
		[SOURce<[1]2>:JBB:C2K:PPARAmeter:DPCH: DATA:RATE	6.139

[SOURce<[1]2>:JBB:C2K:PPARameter:EXECute... 6.137	[SOURce<[1]2>:JBB:DM:DLISt:CoPY..... 6.213
[SOURce<[1]2>:JBB:C2K:PPARameter: PCHannel[:STATe]..... 6.138	[SOURce<[1]2>:JBB:DM:DLISt:DATA ..... 6.214
[SOURce<[1]2>:JBB:C2K:PPARameter: PiCHannel[:STATe]..... 6.138	[SOURce<[1]2>:JBB:DM:DLISt:DATA? ..... 6.214
[SOURce<[1]2>:JBB:C2K:PPARameter: RCONfiguration..... 6.138	[SOURce<[1]2>:JBB:DM:DLISt:DATA:APPend ..... 6.215
[SOURce<[1]2>:JBB:C2K:PPARameter: SCHannel[:STATe]..... 6.139	[SOURce<[1]2>:JBB:DM:DLISt:DELeTe ..... 6.215
[SOURce<[1]2>:JBB:C2K:PPARameter:TCHannel: CoUNT..... 6.139	[SOURce<[1]2>:JBB:DM:DLISt:POINts ..... 6.215
[SOURce<[1]2>:JBB:C2K:PPARameter:TCHannel: DCCChannel[:STATe]..... 6.140	[SOURce<[1]2>:JBB:DM:DLISt:SELeCt ..... 6.216
[SOURce<[1]2>:JBB:C2K:PPARameter:TCHannel: FCHannel[:STATe]..... 6.140	[SOURce<[1]2>:JBB:DM:DLISt:TAg? ..... 6.216
[SOURce<[1]2>:JBB:C2K:PPARameter:TCHannel: FLENgth..... 6.140	[SOURce<[1]2>:JBB:DM:FiLTer:PARAmeter: APCO25 ..... 6.191
[SOURce<[1]2>:JBB:C2K:PPARameter:TCHannel: SCHannel:CoUNT..... 6.141	[SOURce<[1]2>:JBB:DM:FiLTer:PARAmeter: CoSiNe ..... 6.191
[SOURce<[1]2>:JBB:C2K:PRESet ..... 6.123	[SOURce<[1]2>:JBB:DM:FiLTer:PARAmeter: GAUSs ..... 6.191
[SOURce<[1]2>:JBB:C2K:SEQuence..... 6.124	[SOURce<[1]2>:JBB:DM:FiLTer:PARAmeter: PGAuss ..... 6.191
[SOURce<[1]2>:JBB:C2K:SETTing:CATalog? ..... 6.124	[SOURce<[1]2>:JBB:DM:FiLTer:PARAmeter: RCOSine ..... 6.192
[SOURce<[1]2>:JBB:C2K:SETTing:DELeTe ..... 6.125	[SOURce<[1]2>:JBB:DM:FiLTer:PARAmeter: SPHase ..... 6.192
[SOURce<[1]2>:JBB:C2K:SETTing:LOAD ..... 6.125	[SOURce<[1]2>:JBB:DM:FiLTer:TYPE ..... 6.192
[SOURce<[1]2>:JBB:C2K:SETTing:STORe ..... 6.125	[SOURce<[1]2>:JBB:DM:FORMat ..... 6.193
[SOURce<[1]2>:JBB:C2K:SLENgth ..... 6.126	[SOURce<[1]2>:JBB:DM:FRAMp:FDELaY ..... 6.195
[SOURce<[1]2>:JBB:C2K:STATe..... 6.126	[SOURce<[1]2>:JBB:DM:MDELaY? ..... 6.194
[SOURce<[1]2>:JBB:C2K:TRIGger [:EXTeRnal<[1]2>]:DELaY..... 6.127	[SOURce<[1]2>:JBB:DM:OBASeband:TRIGger: iNHibit..... 6.203
[SOURce<[1]2>:JBB:C2K:TRIGger [:EXTeRnal<[1]2>]:iNHibit..... 6.128	[SOURce<[1]2>:JBB:DM:PATteRn ..... 6.194
[SOURce<[1]2>:JBB:C2K:TRIGger:ARM:EXECute ..... 6.126	[SOURce<[1]2>:JBB:DM:PRAMp[:STATe] ..... 6.196
[SOURce<[1]2>:JBB:C2K:TRIGger:EXECute ..... 6.127	[SOURce<[1]2>:JBB:DM:PRAMp:ATTenuation ..... 6.194
[SOURce<[1]2>:JBB:C2K:TRIGger:OBASeband: iNHibit..... 6.128	[SOURce<[1]2>:JBB:DM:PRAMp:BBONly[:STATe] ..... 6.195
[SOURce<[1]2>:JBB:C2K:TRIGger:OBASeband: DELaY..... 6.128	[SOURce<[1]2>:JBB:DM:PRAMp:RDELaY ..... 6.195
[SOURce<[1]2>:JBB:C2K:TRIGger:OUTPut<[1]...4>: DELaY..... 6.129	[SOURce<[1]2>:JBB:DM:PRAMp:SHAPE ..... 6.195
[SOURce<[1]2>:JBB:C2K:TRIGger:OUTPut<[1]...4>: DELaY:FiXed..... 6.129	[SOURce<[1]2>:JBB:DM:PRAMp:SoURce ..... 6.196
[SOURce<[1]2>:JBB:C2K:TRIGger:OUTPut<[1]...4>: DELaY:MAxiMum? ..... 6.129	[SOURce<[1]2>:JBB:DM:PRAMp:TiME ..... 6.196
[SOURce<[1]2>:JBB:C2K:TRIGger:OUTPut<[1]...4>: DELaY:MiNiMum? ..... 6.130	[SOURce<[1]2>:JBB:DM:PRBS[:LENgth] ..... 6.197
[SOURce<[1]2>:JBB:C2K:TRIGger:OUTPut<[1]...4>: MoDE ..... 6.131	[SOURce<[1]2>:JBB:DM:PRESet ..... 6.197
[SOURce<[1]2>:JBB:C2K:TRIGger:OUTPut<[1]...4>: OFFTime..... 6.131	[SOURce<[1]2>:JBB:DM:SEQuence ..... 6.198
[SOURce<[1]2>:JBB:C2K:TRIGger:OUTPut<[1]...4>: ONTime..... 6.132	[SOURce<[1]2>:JBB:DM:SETTing:CATalog? ..... 6.216
[SOURce<[1]2>:JBB:C2K:TRIGger:OUTPut<[1]...4>: PERiod..... 6.132	[SOURce<[1]2>:JBB:DM:SETTing:DELeTe ..... 6.217
[SOURce<[1]2>:JBB:C2K:TRIGger:RMoDE? ..... 6.133	[SOURce<[1]2>:JBB:DM:SETTing:LOAD ..... 6.217
[SOURce<[1]2>:JBB:C2K:TRIGger:SLENgth ..... 6.133	[SOURce<[1]2>:JBB:DM:SETTing:STORe ..... 6.217
[SOURce<[1]2>:JBB:C2K:TRIGger:SLUNit ..... 6.134	[SOURce<[1]2>:JBB:DM:SoURce..... 6.199
[SOURce<[1]2>:JBB:C2K:TRIGger:SoURce ..... 6.134	[SOURce<[1]2>:JBB:DM:SRATe ..... 6.199
[SOURce<[1]2>:JBB:C2K:VERSiOn? ..... 6.135	[SOURce<[1]2>:JBB:DM:STANdard ..... 6.200
[SOURce<[1]2>:JBB:C2K:WAVeform:CREate ..... 6.135	[SOURce<[1]2>:JBB:DM:STANdard:ULISt: CATalog? ..... 6.218
[SOURce<[1]2>:JBB:CFACtor? ..... 6.315	[SOURce<[1]2>:JBB:DM:STANdard:ULISt:DELeTe.. 6.218
[SOURce<[1]2>:JBB:DM:ASK:DEPTH..... 6.188	[SOURce<[1]2>:JBB:DM:STANdard:ULISt:LOAD... 6.218
[SOURce<[1]2>:JBB:DM:CLISt:CATalog?..... 6.210	[SOURce<[1]2>:JBB:DM:STANdard:ULISt:STORe.. 6.219
[SOURce<[1]2>:JBB:DM:CLISt:CoPY ..... 6.210	[SOURce<[1]2>:JBB:DM:STATe ..... 6.200
[SOURce<[1]2>:JBB:DM:CLISt:DATA ..... 6.211	[SOURce<[1]2>:JBB:DM:SWITChing:SoURce ..... 6.200
[SOURce<[1]2>:JBB:DM:CLISt:DELeTe ..... 6.211	[SOURce<[1]2>:JBB:DM:SWITChing:STATe ..... 6.201
[SOURce<[1]2>:JBB:DM:CLISt:POINts? ..... 6.212	[SOURce<[1]2>:JBB:DM:TRIGger [:EXTeRnal<[1]2>]:DELaY ..... 6.202
[SOURce<[1]2>:JBB:DM:CLISt:SELeCt ..... 6.212	[SOURce<[1]2>:JBB:DM:TRIGger [:EXTeRnal<[1]2>]:iNHibit ..... 6.202
[SOURce<[1]2>:JBB:DM:CLISt:TAg? ..... 6.212	[SOURce<[1]2>:JBB:DM:TRIGger:ARM:EXECute... 6.201
[SOURce<[1]2>:JBB:DM:CLoCK:MoDE ..... 6.189	[SOURce<[1]2>:JBB:DM:TRIGger:EXECute..... 6.201
[SOURce<[1]2>:JBB:DM:CLoCK:MuLTIplieR ..... 6.189	[SOURce<[1]2>:JBB:DM:TRIGger:OBASeband: DELaY..... 6.202
[SOURce<[1]2>:JBB:DM:CLoCK:SoURce..... 6.190	[SOURce<[1]2>:JBB:DM:TRIGger:OUTPut<[1]...4>: DELaY..... 6.203
[SOURce<[1]2>:JBB:DM:CoDing ..... 6.190	[SOURce<[1]2>:JBB:DM:TRIGger:OUTPut<[1]...4>: DELaY:MAxiMum? ..... 6.204
[SOURce<[1]2>:JBB:DM:DLISt:CATalog?..... 6.213	[SOURce<[1]2>:JBB:DM:TRIGger:OUTPut<[1]...4>: DELaY:MiNiMum? ..... 6.204
	[SOURce<[1]2>:JBB:DM:TRIGger:OUTPut<[1]...4>: MoDE..... 6.205
	[SOURce<[1]2>:JBB:DM:TRIGger:OUTPut<[1]...4>: OFFTime..... 6.205
	[SOURce<[1]2>:JBB:DM:TRIGger:OUTPut<[1]...4>: ONTime..... 6.206

[SOURCE<[1]2>:]BB:DM:TRIGGER:OUTPUT<[1]...4>: PULSE:DIVIDER.....	6.206	[SOURCE<[1]2>:]BB:GPS:SATELLITE<1 2 3 4>: CACRate.....	6.248, 6.249
[SOURCE<[1]2>:]BB:DM:TRIGGER:OUTPUT<[1]...4>: PULSE:FREQUENCY?.....	6.207	[SOURCE<[1]2>:]BB:GPS:SATELLITE<1 2 3 4>:DSHIFT .....	6.248
[SOURCE<[1]2>:]BB:DM:TRIGGER:OUTPUT<[1]...4>: PATTERN.....	6.206	[SOURCE<[1]2>:]BB:GPS:SATELLITE<1 2 3 4>: PCRate.....	6.249
[SOURCE<[1]2>:]BB:DM:TRIGGER:OUTPUT:DELAY: FIXED.....	6.203	[SOURCE<[1]2>:]BB:GPS:SATELLITE<1 2 3 4>: POWER.....	6.250
[SOURCE<[1]2>:]BB:DM:TRIGGER:RMODE?.....	6.207	[SOURCE<[1]2>:]BB:GPS:SATELLITE<1 2 3 4>: RCODE.....	6.250
[SOURCE<[1]2>:]BB:DM:TRIGGER:SLNGTH.....	6.208	[SOURCE<[1]2>:]BB:GPS:SATELLITE<1 2 3 4>: STATE.....	6.250
[SOURCE<[1]2>:]BB:DM:TRIGGER:SOURC.....	6.208	[SOURCE<[1]2>:]BB:GPS:SATELLITE<1 2 3 4>: TSCHIPS.....	6.250
[SOURCE<[1]2>:]BB:OFFSET.....	6.53	[SOURCE<[1]2>:]BB:GPS:SATELLITE<1 2 3 4>: TSSeconds.....	6.251
[SOURCE<[1]2>:]BB:GPS:CLOCK:MODE.....	6.222	[SOURCE<[1]2>:]BB:GPS:SATELLITE<1 2 3 4>:VID... .....	6.251
[SOURCE<[1]2>:]BB:GPS:CLOCK:MULTIPLIER.....	6.222	[SOURCE<[1]2>:]BB:GPS:SEQUENCE.....	6.227
[SOURCE<[1]2>:]BB:GPS:CLOCK:SOURC.....	6.223	[SOURCE<[1]2>:]BB:GPS:SETTING:CATALOG?.....	6.228
[SOURCE<[1]2>:]BB:GPS:LOCATION.....	6.223	[SOURCE<[1]2>:]BB:GPS:SETTING:DELETE.....	6.228
[SOURCE<[1]2>:]BB:GPS:LOCATION:ALITUDE.....	6.223	[SOURCE<[1]2>:]BB:GPS:SETTING:LOAD.....	6.228
[SOURCE<[1]2>:]BB:GPS:LOCATION:LATITUDE: DEGREES.....	6.224	[SOURCE<[1]2>:]BB:GPS:SETTING:STORE.....	6.229
[SOURCE<[1]2>:]BB:GPS:LOCATION:LATITUDE: DIRection.....	6.224	[SOURCE<[1]2>:]BB:GPS:SMODE.....	6.229
[SOURCE<[1]2>:]BB:GPS:LOCATION:LATITUDE: MINutes.....	6.224	[SOURCE<[1]2>:]BB:GPS:SPREADING[STATE].....	6.229
[SOURCE<[1]2>:]BB:GPS:LOCATION:LATITUDE: SECONDS.....	6.224	[SOURCE<[1]2>:]BB:GPS:STATE.....	6.230
[SOURCE<[1]2>:]BB:GPS:LOCATION:LONGITUDE: DEGREES.....	6.225	[SOURCE<[1]2>:]BB:GPS:TRIGGER [EXTERNAL<[1]2>]:DELAY.....	6.231
[SOURCE<[1]2>:]BB:GPS:LOCATION:LONGITUDE: DIRection.....	6.225	[SOURCE<[1]2>:]BB:GPS:TRIGGER [EXTERNAL<[1]2>]:INHIBIT.....	6.231
[SOURCE<[1]2>:]BB:GPS:LOCATION:LONGITUDE: MINutes.....	6.225	[SOURCE<[1]2>:]BB:GPS:TRIGGER:ARM:EXECUTE.....	6.230
[SOURCE<[1]2>:]BB:GPS:LOCATION:LONGITUDE: SECONDS.....	6.225	[SOURCE<[1]2>:]BB:GPS:TRIGGER:EXECUTE.....	6.231
[SOURCE<[1]2>:]BB:GPS:NAVIGATION:ALMANAC.....	6.241	[SOURCE<[1]2>:]BB:GPS:TRIGGER:OBASBAND: INHIBIT.....	6.232
[SOURCE<[1]2>:]BB:GPS:NAVIGATION:ALMANAC: BEGIN:DAY.....	6.241	[SOURCE<[1]2>:]BB:GPS:TRIGGER:OBASBAND: DELAY.....	6.232
[SOURCE<[1]2>:]BB:GPS:NAVIGATION:ALMANAC: BEGIN:MONTH.....	6.242	[SOURCE<[1]2>:]BB:GPS:TRIGGER:OUTPUT<[1]...4>: DELAY.....	6.232
[SOURCE<[1]2>:]BB:GPS:NAVIGATION:ALMANAC: BEGIN:WNUMBER.....	6.242	[SOURCE<[1]2>:]BB:GPS:TRIGGER:OUTPUT<[1]...4>: DELAY:FIXED.....	6.233
[SOURCE<[1]2>:]BB:GPS:NAVIGATION:ALMANAC: BEGIN:YEAR.....	6.243	[SOURCE<[1]2>:]BB:GPS:TRIGGER:OUTPUT<[1]...4>: DELAY:MAXIMUM?.....	6.233
[SOURCE<[1]2>:]BB:GPS:NAVIGATION:ALMANAC: END:DAY.....	6.243	[SOURCE<[1]2>:]BB:GPS:TRIGGER:OUTPUT<[1]...4>: DELAY:MINIMUM?.....	6.233
[SOURCE<[1]2>:]BB:GPS:NAVIGATION:ALMANAC: END:MONTH.....	6.244	[SOURCE<[1]2>:]BB:GPS:TRIGGER:OUTPUT<[1]...4>: MODE.....	6.234
[SOURCE<[1]2>:]BB:GPS:NAVIGATION:ALMANAC: END:TOEPHEMERIS.....	6.245	[SOURCE<[1]2>:]BB:GPS:TRIGGER:OUTPUT<[1]...4>: OFFTIME.....	6.235
[SOURCE<[1]2>:]BB:GPS:NAVIGATION:ALMANAC: END:YEAR.....	6.244	[SOURCE<[1]2>:]BB:GPS:TRIGGER:OUTPUT<[1]...4>: ONTIME.....	6.235
[SOURCE<[1]2>:]BB:GPS:NAVIGATION:DATA.....	6.245	[SOURCE<[1]2>:]BB:GPS:TRIGGER:OUTPUT<[1]...4>: PULSE:DIVIDER.....	6.236
[SOURCE<[1]2>:]BB:GPS:NAVIGATION:DATA: DSELECT.....	6.246	[SOURCE<[1]2>:]BB:GPS:TRIGGER:OUTPUT<[1]...4>: PULSE:FREQUENCY?.....	6.236
[SOURCE<[1]2>:]BB:GPS:NAVIGATION:DATA: PATTERN.....	6.246	[SOURCE<[1]2>:]BB:GPS:TRIGGER:OUTPUT<[1]...4>: PATTERN.....	6.235
[SOURCE<[1]2>:]BB:GPS:NAVIGATION: SIMULATION[BEGIN]:DAY.....	6.246	[SOURCE<[1]2>:]BB:GPS:TRIGGER:RMODE?.....	6.237
[SOURCE<[1]2>:]BB:GPS:NAVIGATION: SIMULATION[BEGIN]:HOUR.....	6.247	[SOURCE<[1]2>:]BB:GPS:TRIGGER:SLNGTH.....	6.237
[SOURCE<[1]2>:]BB:GPS:NAVIGATION: SIMULATION[BEGIN]:MINUTE.....	6.247	[SOURCE<[1]2>:]BB:GPS:TRIGGER:SOURC.....	6.239
[SOURCE<[1]2>:]BB:GPS:NAVIGATION: SIMULATION[BEGIN]:MONTH.....	6.247	[SOURCE<[1]2>:]BB:GSM[FRAME<[1]2>]: MULTISLOT<0[1]...7>:COUNT.....	6.259
[SOURCE<[1]2>:]BB:GPS:NAVIGATION: SIMULATION[BEGIN]:SECOND.....	6.247	[SOURCE<[1]2>:]BB:GSM[FRAME<[1]2>]: MULTISLOT<0[1]...7>:STATE.....	6.259
[SOURCE<[1]2>:]BB:GPS:NAVIGATION: SIMULATION[BEGIN]:YEAR.....	6.248	[SOURCE<[1]2>:]BB:GSM[FRAME<[1]2>]: PREDEFINED:CATALOG?.....	6.260
[SOURCE<[1]2>:]BB:GPS:POWER[TOTAL].....	6.226	[SOURCE<[1]2>:]BB:GSM[FRAME<[1]2>]: PREDEFINED:LOAD.....	6.260
[SOURCE<[1]2>:]BB:GPS:POWER:ADJUST.....	6.226	[SOURCE<[1]2>:]BB:GSM[FRAME<[1]2>]: SLOT<0[1]...7>:USER<[1]2>[:SOURC]:DATA.....	6.265
[SOURCE<[1]2>:]BB:GPS:PRESET.....	6.226	[SOURCE<[1]2>:]BB:GSM[FRAME<[1]2>]: SLOT<0[1]...7>:USER<[1]2>[:SOURC]:DATA: DLIST.....	6.266
[SOURCE<[1]2>:]BB:GPS:PRFLEVEL.....	6.227		
[SOURCE<[1]2>:]BB:GPS:SATELLITE<1 2 3 4>: FREQUENCY.....	6.249		

[SOURce<[1]2>:JBB:GSM[:FRAMe<[1]2>]: SLOT<0[1]...7>[:USER<[1]2>][:SOURce]:DATA: DLISt:CATalog?.....	6.266	[SOURce<[1]2>:JBB:GSM:SETTing:DELeTe.....	6.276
[SOURce<[1]2>:JBB:GSM[:FRAMe<[1]2>]: SLOT<0[1]...7>[:USER<[1]2>][:SOURce]:DATA: PATTern.....	6.267	[SOURce<[1]2>:JBB:GSM:SETTing:LOAD.....	6.276
[SOURce<[1]2>:JBB:GSM[:FRAMe<[1]2>]: SLOT<0[1]...7>[:USER<[1]2>][:SOURce]:TSC: USER.....	6.267	[SOURce<[1]2>:JBB:GSM:SETTing:STORe.....	6.277
[SOURce<[1]2>:JBB:GSM[:FRAMe<[1]2>]: SLOT<0[1]...7>[:USER<[1]2>]:ATTenuation.....	6.261	[SOURce<[1]2>:JBB:GSM:SMODe.....	6.278
[SOURce<[1]2>:JBB:GSM[:FRAMe<[1]2>]: SLOT<0[1]...7>[:USER<[1]2>]:ETSC.....	6.262	[SOURce<[1]2>:JBB:GSM:SRATe.....	6.278
[SOURce<[1]2>:JBB:GSM[:FRAMe<[1]2>]: SLOT<0[1]...7>[:USER<[1]2>]:FCORrection:FIXed	6.262	[SOURce<[1]2>:JBB:GSM:STATe.....	6.278
[SOURce<[1]2>:JBB:GSM[:FRAMe<[1]2>]: SLOT<0[1]...7>[:USER<[1]2>]:FCORrection:FIXed: PATTern.....	6.263	[SOURce<[1]2>:JBB:GSM:TRIGger [:EXTernal<[1]2>]:DELay.....	6.281
[SOURce<[1]2>:JBB:GSM[:FRAMe<[1]2>]: SLOT<0[1]...7>[:USER<[1]2>]:LEVel.....	6.263	[SOURce<[1]2>:JBB:GSM:TRIGger [:EXTernal<[1]2>]:INHibit.....	6.281
[SOURce<[1]2>:JBB:GSM[:FRAMe<[1]2>]: SLOT<0[1]...7>[:USER<[1]2>]:SFLag.....	6.264	[SOURce<[1]2>:JBB:GSM:TRIGger<[1]2>: OBASeband:DELay.....	6.281
[SOURce<[1]2>:JBB:GSM[:FRAMe<[1]2>]: SLOT<0[1]...7>[:USER<[1]2>]:SFLag:USE.....	6.265	[SOURce<[1]2>:JBB:GSM:TRIGger:ARM:EXECute	6.279
[SOURce<[1]2>:JBB:GSM[:FRAMe<[1]2>]: SLOT<0[1]...7>[:USER<[1]2>]:SYNC:SElect.....	6.267	[SOURce<[1]2>:JBB:GSM:TRIGger:EXECute.....	6.279
[SOURce<[1]2>:JBB:GSM[:FRAMe<[1]2>]: SLOT<0[1]...7>[:USER<[1]2>]:SYNC:USER.....	6.268	[SOURce<[1]2>:JBB:GSM:TRIGger:EXTernal: CLOCK:DELay.....	6.280
[SOURce<[1]2>:JBB:GSM[:FRAMe<[1]2>]: SLOT<0[1]...7>[:USER<[1]2>]:TSC:SElect.....	6.268	[SOURce<[1]2>:JBB:GSM:TRIGger:EXTernal: CLOCK:INHibit.....	6.280
[SOURce<[1]2>:JBB:GSM[:FRAMe<[1]2>]: SLOT<0[1]...7>[:USER<[1]2>]:ULISt:CATalog?....	6.269	[SOURce<[1]2>:JBB:GSM:TRIGger:OBASeband: INHibit.....	6.282
[SOURce<[1]2>:JBB:GSM[:FRAMe<[1]2>]: SLOT<0[1]...7>[:USER<[1]2>]:ULISt:DELete.....	6.269	[SOURce<[1]2>:JBB:GSM:TRIGger:OUTPut<[1]...4>: DELay.....	6.282
[SOURce<[1]2>:JBB:GSM[:FRAMe<[1]2>]: SLOT<0[1]...7>[:USER<[1]2>]:ULISt:LOAD.....	6.270	[SOURce<[1]2>:JBB:GSM:TRIGger:OUTPut<[1]...4>: DELay:MAXimum?.....	6.283
[SOURce<[1]2>:JBB:GSM[:FRAMe<[1]2>]: SLOT<0[1]...7>[:USER<[1]2>]:ULISt:STORe.....	6.270	[SOURce<[1]2>:JBB:GSM:TRIGger:OUTPut<[1]...4>: DELay:MINimum?.....	6.283
[SOURce<[1]2>:JBB:GSM[:FRAMe<[1]2>]: SLOT<0[1]...7>:TYPE.....	6.261	[SOURce<[1]2>:JBB:GSM:TRIGger:OUTPut<[1]...4>: MODE.....	6.284
[SOURce<[1]2>:JBB:GSM[:SATTenuation.....	6.275	[SOURce<[1]2>:JBB:GSM:TRIGger:OUTPut<[1]...4>: OFFTime.....	6.285
[SOURce<[1]2>:JBB:GSM[:FRAMe<[1]2>]: SLOT<0[1]...7>[:USER<[1]2>]:PREDeFined: CATalog?.....	6.264	[SOURce<[1]2>:JBB:GSM:TRIGger:OUTPut<[1]...4>: ONTime.....	6.285
[SOURce<[1]2>:JBB:GSM[:FRAMe<[1]2>]: SLOT<0[1]...7>[:USER<[1]2>]:PREDeFined:LOAD	6.264	[SOURce<[1]2>:JBB:GSM:TRIGger:OUTPut<[1]...4>: PERiod[:FRAMe].....	6.286
[SOURce<[1]2>:JBB:GSM:CLOCK:DIVider.....	6.255	[SOURce<[1]2>:JBB:GSM:TRIGger:OUTPut<[1]...4>: PERiod:SLOT.....	6.286
[SOURce<[1]2>:JBB:GSM:CLOCK:MODE.....	6.256	[SOURce<[1]2>:JBB:GSM:TRIGger:OUTPut<[1]...4>: PULSe[:FREQuency]?.....	6.287
[SOURce<[1]2>:JBB:GSM:CLOCK:MULTiplier.....	6.256	[SOURce<[1]2>:JBB:GSM:TRIGger:OUTPut<[1]...4>: PULSe:DIVider.....	6.286
[SOURce<[1]2>:JBB:GSM:CLOCK:SOURce.....	6.257	[SOURce<[1]2>:JBB:GSM:TRIGger: OUTPut<[1]...4>PATTern.....	6.285
[SOURce<[1]2>:JBB:GSM:EDGE:FORMat?.....	6.257	[SOURce<[1]2>:JBB:GSM:TRIGger:OUTPut: DELay:FIXed.....	6.282
[SOURce<[1]2>:JBB:GSM:FILEr:EDGE:TYPE.....	6.257	[SOURce<[1]2>:JBB:GSM:TRIGger:RMODE?.....	6.287
[SOURce<[1]2>:JBB:GSM:FILEr:PARAMeter.....	6.258	[SOURce<[1]2>:JBB:GSM:TRIGger:SLENgth.....	6.288
[SOURce<[1]2>:JBB:GSM:FILEr:TYPE.....	6.258	[SOURce<[1]2>:JBB:GSM:TRIGger:SLUNit.....	6.288
[SOURce<[1]2>:JBB:GSM:FORMat.....	6.258	[SOURce<[1]2>:JBB:GSM:TRIGger:SOURce.....	6.289
[SOURce<[1]2>:JBB:GSM:FRAMe<[1]2>: REPetitions.....	6.260	[SOURce<[1]2>:JBB:IMPairment:IQRatio.....	6.290
[SOURce<[1]2>:JBB:GSM:FRAMe:ULISt:CATalog?.....	6.271	[SOURce<[1]2>:JBB:IMPairment:LEAKAge:I.....	6.291
[SOURce<[1]2>:JBB:GSM:FRAMe:ULISt:DELete.....	6.271	[SOURce<[1]2>:JBB:IMPairment:LEAKAge:Q.....	6.291
[SOURce<[1]2>:JBB:GSM:FRAMe:ULISt:LOAD.....	6.271	[SOURce<[1]2>:JBB:IMPairment:OPTimization: STATe.....	6.291
[SOURce<[1]2>:JBB:GSM:FRAMe:ULISt:STORe.....	6.272	[SOURce<[1]2>:JBB:IMPairment:STATe.....	6.292
[SOURce<[1]2>:JBB:GSM:FSK:DEViation.....	6.272	[SOURce<[1]2>:JBB:IQGain.....	6.292
[SOURce<[1]2>:JBB:GSM:ISLength.....	6.272	[SOURce<[1]2>:JBB:MCCW:CARRier:COUNT.....	6.295
[SOURce<[1]2>:JBB:GSM:MODE.....	6.273	[SOURce<[1]2>:JBB:MCCW:CARRier:LIST:PHASe	6.296
[SOURce<[1]2>:JBB:GSM:PRAMp:BBONly[:STATe].....	6.273	[SOURce<[1]2>:JBB:MCCW:CARRier:LIST:POWer	6.296
[SOURce<[1]2>:JBB:GSM:PRAMp:FDELay.....	6.273	[SOURce<[1]2>:JBB:MCCW:CARRier:LIST:STATe	6.297
[SOURce<[1]2>:JBB:GSM:PRAMp:RDELay.....	6.274	[SOURce<[1]2>:JBB:MCCW:CARRier:PHASe.....	6.297
[SOURce<[1]2>:JBB:GSM:PRAMp:SHAPE.....	6.274	[SOURce<[1]2>:JBB:MCCW:CARRier:POWer.....	6.297
[SOURce<[1]2>:JBB:GSM:PRAMp:TIME.....	6.274	[SOURce<[1]2>:JBB:MCCW:CARRier:SPACing.....	6.298
[SOURce<[1]2>:JBB:GSM:PRESet.....	6.275	[SOURce<[1]2>:JBB:MCCW:CARRier:STATe.....	6.298
[SOURce<[1]2>:JBB:GSM:SEQUence.....	6.277	[SOURce<[1]2>:JBB:MCCW:CFACTOR.....	6.298
[SOURce<[1]2>:JBB:GSM:SETTing:CATalog?.....	6.276	[SOURce<[1]2>:JBB:MCCW:CFACTOR:ACTual.....	6.299
		[SOURce<[1]2>:JBB:MCCW:CFACTOR:MODE.....	6.299
		[SOURce<[1]2>:JBB:MCCW:CLOCK?.....	6.300
		[SOURce<[1]2>:JBB:MCCW:CLOCK:MODE.....	6.300
		[SOURce<[1]2>:JBB:MCCW:CLOCK:MULTiplier.....	6.301
		[SOURce<[1]2>:JBB:MCCW:CLOCK:SOURce.....	6.301
		[SOURce<[1]2>:JBB:MCCW:EDIT:CARRier: EXECute.....	6.302

[SOURce<[1]2>:]BB:MCCW:EDIT:CARRier: PHASe[.STARt].....	6.302	[SOURce<[1]2>:]BB:TDSCdma:DOWN   UP: CELL<[1]2[3]4>:SLOT<[0] 6>:CHANnel<[0]...21>: DPCC	
[SOURce<[1]2>:]BB:MCCW:EDIT:CARRier:PHASe: STEP .....	6.303	SYNC	
[SOURce<[1]2>:]BB:MCCW:EDIT:CARRier: POWER[.STARt].....	6.303	LENgth .....	6.365
[SOURce<[1]2>:]BB:MCCW:EDIT:CARRier:POWER: STEP .....	6.303	PATtern .....	6.365
[SOURce<[1]2>:]BB:MCCW:EDIT:CARRier:STARt	6.304	REPetition .....	6.365
[SOURce<[1]2>:]BB:MCCW:EDIT:CARRier:STATe	6.304	TFCI	
[SOURce<[1]2>:]BB:MCCW:EDIT:CARRier:STOP	6.304	LENgth .....	6.366
[SOURce<[1]2>:]BB:MCCW:SEQUence .....	6.306	VALue .....	6.366
[SOURce<[1]2>:]BB:MCCW:STANdard .....	6.305	TPC	
[SOURce<[1]2>:]BB:MCCW:STATe .....	6.306	DATA .....	6.366
[SOURce<[1]2>:]BB:MCCW:TRIGger [:EXtErnal<[1]2>]:DELay .....	6.308	[SOURce<[1]2>:]BB:TDSCdma:DOWN   UP: CELL<[1]2[3]4>:SLOT<[0] 6>:CHANnel<[0]...21>: ENHanced? .....	6.368
[SOURce<[1]2>:]BB:MCCW:TRIGger [:EXtErnal<[1]2>]:INHibit .....	6.308	[SOURce<[1]2>:]BB:TDSCdma:DOWN   UP: CELL<[1]2[3]4>:SLOT<[0] 6>:CHANnel<[0]...21>: MSHift? .....	6.369
[SOURce<[1]2>:]BB:MCCW:TRIGger:ARM: EXECute .....	6.307	[SOURce<[1]2>:]BB:TDSCdma:DOWN   UP: CELL<[1]2[3]4>:SLOT<[0] 6>:CHANnel<[0]...21>: POWer.....	6.369
[SOURce<[1]2>:]BB:MCCW:TRIGger:EXECute .....	6.307	[SOURce<[1]2>:]BB:TDSCdma:DOWN   UP: CELL<[1]2[3]4>:SLOT<[0] 6>:CHANnel<[0]...21>: SCODE .....	6.369
[SOURce<[1]2>:]BB:MCCW:TRIGger:OBASeband: DELay .....	6.308	[SOURce<[1]2>:]BB:TDSCdma:DOWN   UP: CELL<[1]2[3]4>:SLOT<[0] 6>:CHANnel<[0]...21>: SFACtor.....	6.370
[SOURce<[1]2>:]BB:MCCW:TRIGger:OBASeband: INHibit .....	6.309	[SOURce<[1]2>:]BB:TDSCdma:DOWN   UP: CELL<[1]2[3]4>:SLOT<[0] 6>:CHANnel<[0]...21>: SFOR? .....	6.370
[SOURce<[1]2>:]BB:MCCW:TRIGger: OUTPut<[1]...4>:DELay.....	6.309	[SOURce<[1]2>:]BB:TDSCdma:DOWN   UP: CELL<[1]2[3]4>:SLOT<[0] 6>:CHANnel<[0]...21>: SFORmat.....	6.370
[SOURce<[1]2>:]BB:MCCW:TRIGger: OUTPut<[1]...4>:DELay:MAXimum? .....	6.310	[SOURce<[1]2>:]BB:TDSCdma:DOWN   UP: CELL<[1]2[3]4>:SLOT<[0] 6>:CHANnel<[0]...21>: TYPE .....	6.371
[SOURce<[1]2>:]BB:MCCW:TRIGger: OUTPut<[1]...4>:DELay:MINimum?.....	6.310	[SOURce<[1]2>:]BB:TDSCdma:DOWN   UP: CELL<[1]2[3]4>:SLOT<[0] 6>:CHANnel<[0]...21>: USER .....	6.371
[SOURce<[1]2>:]BB:MCCW:TRIGger: OUTPut<[1]...4>:MODE.....	6.311	[SOURce<[1]2>:]BB:TDSCdma:DOWN   UP: CELL<[1]2[3]4>:SLOT<[0] 6>:CHANnel<[0]...21>: DPCC	
[SOURce<[1]2>:]BB:MCCW:TRIGger: OUTPut<[1]...4>:OFFTime .....	6.311	TPC	
[SOURce<[1]2>:]BB:MCCW:TRIGger: OUTPut<[1]...4>:ONTIME .....	6.312	READ .....	6.368
[SOURce<[1]2>:]BB:MCCW:TRIGger: OUTPut<[1]...4>:PULSe:DIVider .....	6.312	[SOURce<[1]2>:]BB:TDSCdma: DOWN   UP: CELL<[1]2[3]4>:SLOT<[0]...6>: CHANnel<[0]...21>:DPCC:TPC:DATA:DSElect.....	6.367
[SOURce<[1]2>:]BB:MCCW:TRIGger: OUTPut<[1]...4>:PULSe:FREquency? .....	6.313	[SOURce<[1]2>:]BB:TDSCdma:DOWN   UP: CELL<[1]2[3]4>:SLOT<[0]...6>: CHANnel<[0]...21>:DPCC:TPC:DATA:PATtern.....	6.367
[SOURce<[1]2>:]BB:MCCW:TRIGger: OUTPut<[1]...4>:PATtern .....	6.312	[SOURce<[1]2>:]BB:TDSCdma: DOWN   UP:CELL<[1]2[3]4>:SPOInt.....	6.343
[SOURce<[1]2>:]BB:MCCW:TRIGger:OUTPut: DELay:FIXed.....	6.309	[SOURce<[1]2>:]BB:TDSCdma:DOWN   UP: CELL<[1]2[3]4>:STATe.....	6.343, 6.344
[SOURce<[1]2>:]BB:MCCW:TRIGger:RMODE? .....	6.313	[SOURce<[1]2>:]BB:TDSCdma:DOWN   UP: CELL<[1]2[3]4>:SYNDI .....	6.344
[SOURce<[1]2>:]BB:MCCW:TRIGger:SLENgth.....	6.314	[SOURce<[1]2>:]BB:TDSCdma:DOWN   UP: CELL<[1]2[3]4>:SYNUI .....	6.344
[SOURce<[1]2>:]BB:MCCW:TRIGger:SOURce.....	6.314	[SOURce<[1]2>:]BB:TDSCdma:DOWN   UP: CELL<[1]2[3]4>:USERS .....	6.344
[SOURce<[1]2>:]BB:PGAin .....	6.54	[SOURce<[1]2>:]BB:TDSCdma:DOWN   UP: CELL1:ENH:DCH:BIT	
[SOURce<[1]2>:]BB:POFFset .....	6.54	LAYer .....	6.346
[SOURce<[1]2>:]BB:POWer:PEAK? .....	6.315	RATE.....	6.347
[SOURce<[1]2>:]BB:POWer:RMS? .....	6.316	STATe .....	6.347
[SOURce<[1]2>:]BB:ROUte .....	6.55	[SOURce<[1]2>:]BB:TDSCdma:DOWN   UP: CELL1:ENH:DCH:BLOCK	
[SOURce<[1]2>:]BB:TDSCdma:CLIPping:LEVel .....	6.319	RATE .....	6.347
[SOURce<[1]2>:]BB:TDSCdma:CLIPping:MODE .....	6.319	STATe .....	6.347
[SOURce<[1]2>:]BB:TDSCdma:CLIPping:STATe .....	6.319	[SOURce<[1]2>:]BB:TDSCdma:DOWN   UP: CELL1:ENH:DCH:BLOCK	
[SOURce<[1]2>:]BB:TDSCdma:CLOCK:MODE .....	6.320	RATE .....	6.347
[SOURce<[1]2>:]BB:TDSCdma:CLOCK:MULtiplier .....	6.320	STATe .....	6.347
[SOURce<[1]2>:]BB:TDSCdma:CLOCK:SOURce.....	6.321	[SOURce<[1]2>:]BB:TDSCdma:DOWN   UP: CELL1:ENH:DCH:BPFR .....	6.348
[SOURce<[1]2>:]BB:TDSCdma:COPY:DESTination .....	6.321		
[SOURce<[1]2>:]BB:TDSCdma:COPY:EXECute.....	6.322		
[SOURce<[1]2>:]BB:TDSCdma:COPY:SOURce .....	6.322		
[SOURce<[1]2>:]BB:TDSCdma:CRATe? .....	6.322		
[SOURce<[1]2>:]BB:TDSCdma:CRATe:VARiation .....	6.323		
[SOURce<[1]2>:]BB:TDSCdma: DOWN   UP:CELL<[1]2[3]4>:DWPTs:POWer.....	6.342		
[SOURce<[1]2>:]BB:TDSCdma:DOWN   UP: CELL<[1]2[3]4>:MCOd.....	6.342		
[SOURce<[1]2>:]BB:TDSCdma:DOWN   UP: CELL<[1]2[3]4>:SCODE .....	6.343		
[SOURce<[1]2>:]BB:TDSCdma:DOWN   UP: STATE.....	6.343		

[SOURce<[1]2>:]BB:TDSCdma:DOWN   UP: CELL1:ENH:DCH:DTCH   DCCH:CRCSize.....	6.348	[SOURce<[1]2>:]BB:TDSCdma:DOWN:CELL1: ENH:BCH:SFOR.....	6.360
[SOURce<[1]2>:]BB:TDSCdma:DOWN   UP: CELL1:ENH:DCH:DTCH   DCCH:DATA.....	6.349	[SOURce<[1]2>:]BB:TDSCdma:DOWN:CELL1: ENH:BCH:SLOTstate<[0]...6>.....	6.360
[SOURce<[1]2>:]BB:TDSCdma:DOWN   UP: CELL1:ENH:DCH:DTCH   DCCH:DATA:DSElect...	6.350	[SOURce<[1]2>:]BB:TDSCdma:DOWN:CELL1: ENH:BCH:STATE.....	6.360
[SOURce<[1]2>:]BB:TDSCdma:DOWN   UP: CELL1:ENH:DCH:DTCH   DCCH:DATA:PATtern...	6.350	[SOURce<[1]2>:]BB:TDSCdma:DOWN:CELL1: ENH:BCH:TYPE.....	6.361
[SOURce<[1]2>:]BB:TDSCdma:DOWN   UP: CELL1:ENH:DCH:DTCH   DCCH:EPRotectioN.....	6.350	[SOURce<[1]2>:]BB:TDSCdma:DOWN: PPARameter:PCCPch:STATE.....	6.341
[SOURce<[1]2>:]BB:TDSCdma:DOWN   UP: CELL1:ENH:DCH:DTCH   DCCH:INTOne.....	6.351	[SOURce<[1]2>:]BB:TDSCdma:DOWN:UP: CELL<[1]2[3]4>:SLOT<[0]...6>:CHANnel<[0]...21>: DATA.....	6.363
[SOURce<[1]2>:]BB:TDSCdma:DOWN   UP: CELL1:ENH:DCH:DTCH   DCCH:INTTwo.....	6.351	DSElect.....	6.364
[SOURce<[1]2>:]BB:TDSCdma:DOWN   UP: CELL1:ENH:DCH:DTCH   DCCH:RMATribute.....	6.351	PATtern.....	6.364
[SOURce<[1]2>:]BB:TDSCdma:DOWN   UP: CELL1:ENH:DCH:DTCH   DCCH:STATE.....	6.351	[SOURce<[1]2>:]BB:TDSCdma:DOWN:UP: CELL<[1]2[3]4>:SLOT<[0]...6>:CHANnel<[0]...21>: DCONflict.....	6.364
[SOURce<[1]2>:]BB:TDSCdma:DOWN   UP: CELL1:ENH:DCH:DTCH   DCCH:TBCount.....	6.352	[SOURce<[1]2>:]BB:TDSCdma:DOWN:UP: CELL<[1]2[3]4>:SLOT<[0]...6>:CHANnel<[0]...21>: STATE.....	6.371
[SOURce<[1]2>:]BB:TDSCdma:DOWN   UP: CELL1:ENH:DCH:DTCH   DCCH:TBSize.....	6.352	[SOURce<[1]2>:]BB:TDSCdma:FILTer:PARAmeter: APCO25.....	6.323
[SOURce<[1]2>:]BB:TDSCdma:DOWN   UP: CELL1:ENH:DCH:DTCH   DCCH:TTINterval.....	6.352	[SOURce<[1]2>:]BB:TDSCdma:FILTer:PARAmeter: COSine.....	6.323
[SOURce<[1]2>:]BB:TDSCdma:DOWN   UP: CELL1:ENH:DCH:HSCH:CVPB.....	6.352	[SOURce<[1]2>:]BB:TDSCdma:FILTer:PARAmeter: GAUSS.....	6.323
[SOURce<[1]2>:]BB:TDSCdma:DOWN   UP: CELL1:ENH:DCH:HSCH:PRSR.....	6.353	[SOURce<[1]2>:]BB:TDSCdma:FILTer:PARAmeter: PGAuss.....	6.324
[SOURce<[1]2>:]BB:TDSCdma:DOWN   UP: CELL1:ENH:DCH:HSCH:PSBS.....	6.353	[SOURce<[1]2>:]BB:TDSCdma:FILTer:PARAmeter: RCOSine.....	6.324
[SOURce<[1]2>:]BB:TDSCdma:DOWN   UP: CELL1:ENH:DCH:HSCH:RVParameter.....	6.353	[SOURce<[1]2>:]BB:TDSCdma:FILTer:PARAmeter: SPHase.....	6.324
[SOURce<[1]2>:]BB:TDSCdma:DOWN   UP: CELL1:ENH:DCH:RUPLayer.....	6.354	[SOURce<[1]2>:]BB:TDSCdma:FILTer:TYPE.....	6.324
[SOURce<[1]2>:]BB:TDSCdma:DOWN   UP: CELL1:ENH:DCH:SCSMoDe.....	6.354	[SOURce<[1]2>:]BB:TDSCdma:LINK.....	6.325
[SOURce<[1]2>:]BB:TDSCdma:DOWN   UP: CELL1:ENH:DCH:SFOR.....	6.354	[SOURce<[1]2>:]BB:TDSCdma:POWer:ADJust.....	6.325
[SOURce<[1]2>:]BB:TDSCdma:DOWN   UP: CELL1:ENH:DCH:SLOTstate<[0]...6>.....	6.355	[SOURce<[1]2>:]BB:TDSCdma:POWer:TOTal.....	6.325
[SOURce<[1]2>:]BB:TDSCdma:DOWN   UP: CELL1:ENH:DCH:STATE.....	6.355	[SOURce<[1]2>:]BB:TDSCdma:PRAMP:BBONly.....	6.326
[SOURce<[1]2>:]BB:TDSCdma:DOWN   UP: CELL1:ENH:DCH:TYPE.....	6.355	[SOURce<[1]2>:]BB:TDSCdma:PRAMP:FDElay...6.326	6.326
[SOURce<[1]2>:]BB:TDSCdma:DOWN   UP: PPARameter:DPCH:COUNt.....	6.339	[SOURce<[1]2>:]BB:TDSCdma:PRAMP:RDElay...6.326	6.326
[SOURce<[1]2>:]BB:TDSCdma:DOWN   UP: PPARameter:DPCH:CRESt.....	6.340	[SOURce<[1]2>:]BB:TDSCdma:PRAMP:SHAPE...6.327	6.327
[SOURce<[1]2>:]BB:TDSCdma:DOWN   UP: PPARameter:DPCH:SFAC.....	6.340	[SOURce<[1]2>:]BB:TDSCdma:PRAMP:TIME.....	6.327
[SOURce<[1]2>:]BB:TDSCdma:DOWN   UP: PPARameter:EXECute.....	6.341	[SOURce<[1]2>:]BB:TDSCdma:PRESet.....	6.327
[SOURce<[1]2>:]BB:TDSCdma:DOWN:CELL1: ENH:BCH:BPFR.....	6.355	[SOURce<[1]2>:]BB:TDSCdma:RESet.....	6.328
[SOURce<[1]2>:]BB:TDSCdma:DOWN:CELL1: ENH:BCH:DTCH CRCSize.....	6.356	[SOURce<[1]2>:]BB:TDSCdma:SEQuence.....	6.328
EPRotectioN.....	6.357	[SOURce<[1]2>:]BB:TDSCdma:SETTing:CATalog?6.329	6.329
INTOne.....	6.358	[SOURce<[1]2>:]BB:TDSCdma:SETTing:DElete...6.329	6.329
INTTwo.....	6.358	[SOURce<[1]2>:]BB:TDSCdma:SETTing:LOAD...6.329	6.329
RMATribute.....	6.358	[SOURce<[1]2>:]BB:TDSCdma:SETTing:STORe...6.330	6.330
STATE.....	6.358	[SOURce<[1]2>:]BB:TDSCdma:SLENgth.....	6.330
TBCount.....	6.359	[SOURce<[1]2>:]BB:TDSCdma:STATE.....	6.330
TBSize.....	6.359	[SOURce<[1]2>:]BB:TDSCdma:TRIGger [:EXTerNal<[1]2>]:DElay.....	6.331
TTINterval.....	6.359	[SOURce<[1]2>:]BB:TDSCdma:TRIGger [:EXTerNal<[1]2>]:INHibit.....	6.332
[SOURce<[1]2>:]BB:TDSCdma:DOWN:CELL1: ENH:BCH:DTCH:DATA.....	6.356	[SOURce<[1]2>:]BB:TDSCdma:TRIGger:ARM: EXECute.....	6.331
[SOURce<[1]2>:]BB:TDSCdma:DOWN:CELL1: ENH:BCH:DTCH:DATA:..PATtern.....	6.357	[SOURce<[1]2>:]BB:TDSCdma:TRIGger:EXECute.6.331	6.331
[SOURce<[1]2>:]BB:TDSCdma:DOWN:CELL1: ENH:BCH:DTCH:DATA:DSElect.....	6.357	[SOURce<[1]2>:]BB:TDSCdma:TRIGger: OBASband:INHibit.....	6.332
[SOURce<[1]2>:]BB:TDSCdma:DOWN:CELL1: ENH:BCH:SCSMoDe.....	6.359	[SOURce<[1]2>:]BB:TDSCdma:TRIGger: OBASeband:DElay.....	6.332
		[SOURce<[1]2>:]BB:TDSCdma:TRIGger: OUTPut<[1]...4>:DElay.....	6.333
		[SOURce<[1]2>:]BB:TDSCdma:TRIGger: OUTPut<[1]...4>:DElay:FIXed.....	6.333
		[SOURce<[1]2>:]BB:TDSCdma:TRIGger: OUTPut<[1]...4>:DElay:MAXimum?.....	6.333
		[SOURce<[1]2>:]BB:TDSCdma:TRIGger: OUTPut<[1]...4>:DElay:MINimum?.....	6.334
		[SOURce<[1]2>:]BB:TDSCdma:TRIGger: OUTPut<[1]...4>:MODE.....	6.334



[SOURce<[1]2>:JBB:TDSCDma:TRIGger: OUTPut<[1]...4>:OFFTime .....	6.335	[SOURce<[1]2>:JBB:W3GPP:BSTation<[1]2 3 4>: CHANnel<10...138>:DPCCCh:TPC:MISe .....	6.522
[SOURce<[1]2>:JBB:TDSCDma:TRIGger: OUTPut<[1]...4>:ONTime .....	6.335	[SOURce<[1]2>:JBB:W3GPP:BSTation<[1]2 3 4>: CHANnel<10...138>:DPCCCh:TPC:PSTep .....	6.522
[SOURce<[1]2>:JBB:TDSCDma:TRIGger: OUTPut<[1]...4>:PERiod .....	6.335	[SOURce<[1]2>:JBB:W3GPP:BSTation<[1]2 3 4>: CHANnel<10...138>:DPCCCh:TPC:READ .....	6.523
[SOURce<[1]2>:JBB:TDSCDma:TRIGger:RMODE? .....	6.336	[SOURce<[1]2>:JBB:W3GPP:BSTation<[1]2 3 4>: CHANnel<11...138>:DPCCCh:MCODE .....	6.518
[SOURce<[1]2>:JBB:TDSCDma:TRIGger:SLenGth .....	6.336	[SOURce<[1]2>:JBB:W3GPP:BSTation<[1]2 3 4>: CHANnel<11...138>:FDPCCCh:TPC:PSTep .....	6.526
[SOURce<[1]2>:JBB:TDSCDma:TRIGger:SLUnit .....	6.337	[SOURce<[1]2>:JBB:W3GPP:BSTation<[1]2 3 4>: CHANnel<11...138>:FDPCCCh:DPCCCh:TPC:DATA .....	6.524
[SOURce<[1]2>:JBB:TDSCDma:TRIGger:SOURce .....	6.337	[SOURce<[1]2>:JBB:W3GPP:BSTation<[1]2 3 4>: CHANnel<11...138>:FDPCh:DPCCCh:TPC:DATA: DSElect .....	6.524
[SOURce<[1]2>:JBB:TDSCDma:UP: CELL<[1]2 3 4>:SLOT<[0]...6>:MODE .....	6.372	[SOURce<[1]2>:JBB:W3GPP:BSTation<[1]2 3 4>: CHANnel<11...138>:FDPCh:DPCCCh:TPC:DATA: PATtern .....	6.525
[SOURce<[1]2>:JBB:TDSCDma:UP: CELL<[1]2 3 4>:SLOT<[0]...6>:PRAC:MSG:DATA .....	6.372	[SOURce<[1]2>:JBB:W3GPP:BSTation<[1]2 3 4>: CHANnel<11...138>:FDPCh:DPCCCh:TPC:MISe .....	6.525
[SOURce<[1]2>:JBB:TDSCDma:UP:CELL<[1]2 3 4>: SLOT<[0]...6>:PRAC:MSG:DATA:DSElect .....	6.373	[SOURce<[1]2>:JBB:W3GPP:BSTation<[1]2 3 4>: CHANnel<11...138>:FDPCh:DPCCCh:TPC:READ .....	6.526
[SOURce<[1]2>:JBB:TDSCDma:UP:CELL<[1]2 3 4>: SLOT<[0]...6>:PRAC:MSG:DATA:PATtern .....	6.373	[SOURce<[1]2>:JBB:W3GPP:BSTation<[1]2 3 4>: CHANnel<11...138>:HSDPa:CVPB .....	6.528
[SOURce<[1]2>:JBB:TDSCDma:UP:CELL<[1]2 3 4>: SLOT<[0]...6>:PRAC:MSG:LEnGth .....	6.373	[SOURce<[1]2>:JBB:W3GPP:BSTation<[1]2 3 4>: CHANnel<4 5 6 9 11...138>:DATA .....	6.517
[SOURce<[1]2>:JBB:TDSCDma:UP:CELL<[1]2 3 4>: SLOT<[0]...6>:PRAC:MSG:MSHift .....	6.374	[SOURce<[1]2>:JBB:W3GPP:BSTation<[1]2 3 4>: CHANnel<4 5 6 9 11...138>:DATA:DSElect .....	6.517
[SOURce<[1]2>:JBB:TDSCDma:UP:CELL<[1]2 3 4>: SLOT<[0]...6>:PRAC:MSG:POWER .....	6.374	[SOURce<[1]2>:JBB:W3GPP:BSTation<[1]2 3 4>: CHANnel<4 5 6 9 11...138>:DATA:PATtern .....	6.518
[SOURce<[1]2>:JBB:TDSCDma:UP:CELL<[1]2 3 4>: SLOT<[0]...6>:PRAC:MSG:SCODE .....	6.374	[SOURce<[1]2>:JBB:W3GPP:BSTation<[1]2 3 4>: CHANnel<5 6 11...138>:TOFFset .....	6.538
[SOURce<[1]2>:JBB:TDSCDma:UP:CELL<[1]2 3 4>: SLOT<[0]...6>:PRAC:MSG:SFACTOR .....	6.374	[SOURce<[1]2>:JBB:W3GPP:BSTation<[1]2 3 4>: CHANnel<5 9...138>:DPCCCh:TFCI .....	6.520
[SOURce<[1]2>:JBB:TDSCDma:UP:CELL<[1]2 3 4>: SLOT<[0]...6>:PRAC:MSG:STATe .....	6.375	[SOURce<[1]2>:JBB:W3GPP:BSTation<[1]2 3 4>: CHANnel<5 9...138>:DPCCCh:TFCI:STATe .....	6.520
[SOURce<[1]2>:JBB:TDSCDma:UP:CELL<[1]2 3 4>: SLOT<[0]...6>:PRAC:MSG:USER .....	6.375	[SOURce<[1]2>:JBB:W3GPP:BSTation<[1]2 3 4>: CHANnel<5 9...138>:SFORmat .....	6.537
[SOURce<[1]2>:JBB:TDSCDma:UP:CELL<[1]2 3 4>: SLOT<[0]...6>:PRAC:PTS:DIStance .....	6.376	[SOURce<[1]2>:JBB:W3GPP:BSTation<[1]2 3 4>: CHANnel<9...138>:HSDPa:BMODE[STATe] .....	6.527
[SOURce<[1]2>:JBB:TDSCDma:UP:CELL<[1]2 3 4>: SLOT<[0]...6>:PRAC:PTS:POWER .....	6.376	[SOURce<[1]2>:JBB:W3GPP:BSTation<[1]2 3 4>: CHANnel<9...138>:HSDPa:MODE .....	6.529
[SOURce<[1]2>:JBB:TDSCDma:UP:CELL<[1]2 3 4>: SLOT<[0]...6>:PRAC:PTS:PSTep .....	6.376	[SOURce<[1]2>:JBB:W3GPP:BSTation<[1]2 3 4>: CHANnel<9...138>:HSDPa:TTIDistance .....	6.531
[SOURce<[1]2>:JBB:TDSCDma:UP:CELL<[1]2 3 4>: SLOT<[0]...6>:PRAC:PTS:REPetition .....	6.377	[SOURce<[1]2>:JBB:W3GPP:BSTation<[1]2 3 4>: CHANnel<9...138>:HSUPa:EHICH:CTYPe .....	6.532
[SOURce<[1]2>:JBB:TDSCDma:UP:CELL<[1]2 3 4>: SLOT<[0]...6>:PRAC:PTS:START .....	6.377	[SOURce<[1]2>:JBB:W3GPP:BSTation<[1]2 3 4>: CHANnel<9...138>:HSUPa:EHICH:DTAU .....	6.532
[SOURce<[1]2>:JBB:TDSCDma:UP:CELL<[1]2 3 4>: SLOT<[0]...6>:PRAC:MSG:SFORmat .....	6.375	[SOURce<[1]2>:JBB:W3GPP:BSTation<[1]2 3 4>: CHANnel<9...138>:HSUPa:EHICH:SSINdex .....	6.533
[SOURce<[1]2>:JBB:TDSCDma:VERsion .....	6.338	[SOURce<[1]2>:JBB:W3GPP:BSTation<[1]2 3 4>: CHANnel<9...138>:HSUPa:EHICH:TTIEdch .....	6.533
[SOURce<[1]2>:JBB:TDSCDma:VERsion? .....	6.338	[SOURce<[1]2>:JBB:W3GPP:BSTation<[1]2 3 4>: CHANnel<9...138>:HSUPa:ERGCh:CTYPe .....	6.534
[SOURce<[1]2>:JBB:TDSCDma:WAVeform:CREate .....	6.338	[SOURce<[1]2>:JBB:W3GPP:BSTation<[1]2 3 4>: CHANnel<9...138>:HSUPa:ERGCh:DTAU .....	6.534
[SOURce<[1]2>:JBB:W3GPP:BSTation[ENHanced]: CHANnel12:HSDPa:DERRor:BIT:LAyer .....	6.565	[SOURce<[1]2>:JBB:W3GPP:BSTation<[1]2 3 4>: CHANnel<9...138>:HSUPa:ERGCh:ETAU .....	6.534
[SOURce<[1]2>:JBB:W3GPP:BSTation[ENHanced]: CHANnel12:HSDPa:DERRor:BIT:RATE .....	6.565	[SOURce<[1]2>:JBB:W3GPP:BSTation<[1]2 3 4>: CHANnel<9...138>:HSUPa:ERGCh:TTIEdch .....	6.535
[SOURce<[1]2>:JBB:W3GPP:BSTation[ENHanced]: CHANnel12:HSDPa:DERRor:BIT:STATe .....	6.566	[SOURce<[1]2>:JBB:W3GPP:BSTation<[1]2 3 4>: CHANnel<9...138>:HSUPa:ERGChh:RGPAtem .....	6.533
[SOURce<[1]2>:JBB:W3GPP:BSTation[ENHanced]: CHANnel12:HSDPa:DERRor:BLOCK:RATE .....	6.566	[SOURce<[1]2>:JBB:W3GPP:BSTation<[1]2 3 4>: CHANnel<9...138>:HSUPa:ERGCh:SSINdex .....	6.535
[SOURce<[1]2>:JBB:W3GPP:BSTation[ENHanced]: CHANnel12:HSDPa:DERRor:BLOCK:STATe .....	6.566	[SOURce<[1]2>:JBB:W3GPP:BSTation<[1]2 3 4>: CHANnel<9...138>:HSUPa:ERGChh:SSINdex .....	6.535
[SOURce<[1]2>:JBB:W3GPP:BSTation<[1]2 3 4>: CHANnel<0 1...138>:POWER .....	6.536	[SOURce<[1]2>:JBB:W3GPP:BSTation<[1]2 3 4>: CHANnel7:AICH:ASLOT .....	6.515
[SOURce<[1]2>:JBB:W3GPP:BSTation<[1]2 3 4>: CHANnel<0 1...138>:SRATE .....	6.537	[SOURce<[1]2>:JBB:W3GPP:BSTation<[1]2 3 4>: CHANnel7:AICH:SAPAttem .....	6.515
[SOURce<[1]2>:JBB:W3GPP:BSTation<[1]2 3 4>: CHANnel<0 1...138>:STATe .....	6.537		
[SOURce<[1]2>:JBB:W3GPP:BSTation<[1]2 3 4>: CHANnel<0 1...138>:TYPE .....	6.538		
[SOURce<[1]2>:JBB:W3GPP:BSTation<[1]2 3 4>: CHANnel<0 1 2 5...138>:CCODE .....	6.516		
[SOURce<[1]2>:JBB:W3GPP:BSTation<[1]2 3 4>: CHANnel<10...138>:DPCCCh:TPC:DATA .....	6.521		
[SOURce<[1]2>:JBB:W3GPP:BSTation<[1]2 3 4>: CHANnel<10...138>:DPCCCh:TPC:DATA:DSElect .....	6.521		
[SOURce<[1]2>:JBB:W3GPP:BSTation<[1]2 3 4>: CHANnel<10...138>:DPCCCh:TPC:DATA:PATtern .....	6.522		

[SOURce<[1]2>:]BB:W3GPP:BSTation<[1]2 3 4>: CHANnel7:APAIch:ASLOt.....	6.515	[SOURce<[1]2>:]BB:W3GPP:BSTation:ENHanced: CHANnel<11...13>:DPCH:DERRor:BIT:STATe.....	6.555
[SOURce<[1]2>:]BB:W3GPP:BSTation<[1]2 3 4>: CHANnel8:APAIch:SAPAttern.....	6.516	[SOURce<[1]2>:]BB:W3GPP:BSTation:ENHanced: CHANnel<11...13>:DPCH:DERRor:BLOCK:RATE.....	6.556
[SOURce<[1]2>:]BB:W3GPP:BSTation<[1]2 3 4>: DCONflict[:STATe]?.....	6.543	[SOURce<[1]2>:]BB:W3GPP:BSTation:ENHanced: CHANnel<11...13>:DPCH:DERRor:BLOCK:STATe.....	6.556
[SOURce<[1]2>:]BB:W3GPP:BSTation<[1]2 3 4>: DCONflict:RESolve.....	6.542	[SOURce<[1]2>:]BB:W3GPP:BSTation:ENHanced: CHANnel<11...13>:DPCH:DPControl[:POWer].....	6.557
[SOURce<[1]2>:]BB:W3GPP:BSTation<[1]2 3 4>: DPCCh:CHANnel<5 10...138>:PLENgtH.....	6.518	[SOURce<[1]2>:]BB:W3GPP:BSTation:ENHanced: CHANnel<11...13>:DPCH:DPControl:DIRectiOn.....	6.556
[SOURce<[1]2>:]BB:W3GPP:BSTation<[1]2 3 4>: DPCCh:CHANnel<5 10...138>:POFFset:PILOt.....	6.519	[SOURce<[1]2>:]BB:W3GPP:BSTation:ENHanced: CHANnel<11...13>:DPCH:DPControl:MODE.....	6.557
[SOURce<[1]2>:]BB:W3GPP:BSTation<[1]2 3 4>: DPCCh:CHANnel<5 8...138>:POFFset:TFCI.....	6.519	[SOURce<[1]2>:]BB:W3GPP:BSTation:ENHanced: CHANnel<11...13>:DPCH:DPControl:RANGE:	
[SOURce<[1]2>:]BB:W3GPP:BSTation<[1]2 3 4>: PINDicator:COUNt.....	6.544	DOWN.....	6.557
[SOURce<[1]2>:]BB:W3GPP:BSTation<[1]2 3 4>: SCODE.....	6.544	[SOURce<[1]2>:]BB:W3GPP:BSTation:ENHanced: CHANnel<11...13>:DPCH:DPControl:RANGE:UP.....	6.558
[SOURce<[1]2>:]BB:W3GPP:BSTation<[1]2 3 4>: SCODE:STATe.....	6.545	[SOURce<[1]2>:]BB:W3GPP:BSTation:ENHanced: CHANnel<11...13>:DPCH:DPControl:STATe.....	6.558
[SOURce<[1]2>:]BB:W3GPP:BSTation<[1]2 3 4>: SCPich:PREFereNce[:STATe].....	6.545	[SOURce<[1]2>:]BB:W3GPP:BSTation:ENHanced: CHANnel<11...13>:DPCH:DPControl:	
[SOURce<[1]2>:]BB:W3GPP:BSTation<[1]2 3 4>: SSCG?.....	6.545	STEP[:EXTerNal].....	6.558
[SOURce<[1]2>:]BB:W3GPP:BSTation<[1]2 3 4>: STATe.....	6.546	[SOURce<[1]2>:]BB:W3GPP:BSTation:ENHanced: CHANnel<11...13>:DPCH:DPControl:STEP:	
[SOURce<[1]2>:]BB:W3GPP:BSTation<[1]2 3 4>: TDIVersity.....	6.546	MANual.....	6.559
[SOURce<[1]2>:]BB:W3GPP:BSTation<2 3 4>: TDELay:STEP.....	6.546	[SOURce<[1]2>:]BB:W3GPP:BSTation:ENHanced: CHANnel<11...13>:DPCH:INTerleaver2.....	6.559
[SOURce<[1]2>:]BB:W3GPP:BSTation<2 3 4>: CMODE:DLFStructure.....	6.539	[SOURce<[1]2>:]BB:W3GPP:BSTation:ENHanced: CHANnel<11...13>:DPCH:STATe.....	6.560
[SOURce<[1]2>:]BB:W3GPP:BSTation<2 3 4>: CMODE:METHod.....	6.539	[SOURce<[1]2>:]BB:W3GPP:BSTation:ENHanced: CHANnel<11...13>:DPCH:TCHannel<0 [1]...6>:	
[SOURce<[1]2>:]BB:W3GPP:BSTation<2 3 4>: CMODE:PATTem<[1]2>:TGD.....	6.540	CRCSize.....	6.560
[SOURce<[1]2>:]BB:W3GPP:BSTation<2 3 4>: CMODE:PATTem<[1]2>:TGL<[1]2>.....	6.540	[SOURce<[1]2>:]BB:W3GPP:BSTation:ENHanced: CHANnel<11...13>:DPCH:TCHannel<0 [1]...6>:	
[SOURce<[1]2>:]BB:W3GPP:BSTation<2 3 4>: CMODE:PATTem<[1]2>:TGPL.....	6.540	DATA.....	6.560
[SOURce<[1]2>:]BB:W3GPP:BSTation<2 3 4>: CMODE:PATTem<[1]2>:TGSN.....	6.541	[SOURce<[1]2>:]BB:W3GPP:BSTation:ENHanced: CHANnel<11...13>:DPCH:TCHannel<0 [1]...6>:	
[SOURce<[1]2>:]BB:W3GPP:BSTation<2 3 4>: CMODE:POFFset.....	6.542	DATA:DSElect.....	6.561
[SOURce<[1]2>:]BB:W3GPP:BSTation<2 3 4>: CMODE:POMode.....	6.541	[SOURce<[1]2>:]BB:W3GPP:BSTation:ENHanced: CHANnel<11...13>:DPCH:TCHannel<0 [1]...6>:	
[SOURce<[1]2>:]BB:W3GPP:BSTation<2 3 4>: CMODE:STATe.....	6.542	DATA:PATTem.....	6.561
[SOURce<[1]2>:]BB:W3GPP:BSTation:CHANnel: HSDPa:HSET:PRESet.....	6.529	[SOURce<[1]2>:]BB:W3GPP:BSTation:ENHanced: CHANnel<11...13>:DPCH:TCHannel<0 [1]...6>:DTX6.....	6.562
[SOURce<[1]2>:]BB:W3GPP:BSTation:CHANnel: PRESet.....	6.536	[SOURce<[1]2>:]BB:W3GPP:BSTation:ENHanced: CHANnel<11...13>:DPCH:TCHannel<0 [1]...6>:	
[SOURce<[1]2>:]BB:W3GPP:BSTation:CHANnel12: HSDPa:CLENgtH?.....	6.527	EPRotectiOn.....	6.562
[SOURce<[1]2>:]BB:W3GPP:BSTation:ENHanced: CHANnel<11...13>:DPCH:CCODing:BPFRame?.....	6.549	[SOURce<[1]2>:]BB:W3GPP:BSTation:ENHanced: CHANnel<11...13>:DPCH:TCHannel<0 [1]...6>:	
[SOURce<[1]2>:]BB:W3GPP:BSTation:ENHanced: CHANnel<11...13>:DPCH:CCODing:SFORmat.....	6.550	INTerleaver<.....	6.563
[SOURce<[1]2>:]BB:W3GPP:BSTation:ENHanced: CHANnel<11...13>:DPCH:CCODing:SRATE?.....	6.550	[SOURce<[1]2>:]BB:W3GPP:BSTation:ENHanced: CHANnel<11...13>:DPCH:TCHannel<0 [1]...6>:	
[SOURce<[1]2>:]BB:W3GPP:BSTation:ENHanced: CHANnel<11...13>:DPCH:CCODing:STATe.....	6.551	RMATrIBUTE.....	6.563
[SOURce<[1]2>:]BB:W3GPP:BSTation:ENHanced: CHANnel<11...13>:DPCH:CCODing:TYPE.....	6.552	[SOURce<[1]2>:]BB:W3GPP:BSTation:ENHanced: CHANnel<11...13>:DPCH:TCHannel<0 [1]...6>:	
[SOURce<[1]2>:]BB:W3GPP:BSTation:ENHanced: CHANnel<11...13>:DPCH:CCODing:USER:LOAD.....	6.554	STATe.....	6.564
[SOURce<[1]2>:]BB:W3GPP:BSTation:ENHanced: CHANnel<11...13>:DPCH:CCODing:USER:		[SOURce<[1]2>:]BB:W3GPP:BSTation:ENHanced: CHANnel<11...13>:DPCH:TCHannel<0 [1]...6>:	
STORed.....	6.554	TBCount.....	6.564
[SOURce<[1]2>:]BB:W3GPP:BSTation:ENHanced: CHANnel<11...13>:DPCH:DERRor:BIT:LAYer.....	6.555	[SOURce<[1]2>:]BB:W3GPP:BSTation:ENHanced: CHANnel<11...13>:DPCH:TCHannel<0 [1]...6>:	
[SOURce<[1]2>:]BB:W3GPP:BSTation:ENHanced: CHANnel<11...13>:DPCH:DERRor:BIT:RATE.....	6.555	TBSize.....	6.564
		[SOURce<[1]2>:]BB:W3GPP:BSTation:ENHanced: CHANnel<11...13>:DPCH:TCHannel<0 [1]...6>:	
		TTINterval.....	6.565
		[SOURce<[1]2>:]BB:W3GPP:BSTation:ENHanced: CHANnel:DPCH:CCODing:USER:CATalog?.....	6.553
		[SOURce<[1]2>:]BB:W3GPP:BSTation:ENHanced: CHANnel:DPCH:CCODing:USER:DELeTe.....	6.553
		[SOURce<[1]2>:]BB:W3GPP:BSTation:ENHanced: PCCPch:CCODing:INTerleaver<[1]2>:STATe.....	6.567
		[SOURce<[1]2>:]BB:W3GPP:BSTation:ENHanced: PCCPch:CCODing:STATe.....	6.567

[SOURce<[1]2>:]BB:W3GPP:BSTation:ENHanced: PCCPch:CCODing:TYPE?.....	6.567	[SOURce<[1]2>:]BB:W3GPP:MSTation<[1]2 3 4>: DPCCh:HS:CQI[:VALues].....	6.585
[SOURce<[1]2>:]BB:W3GPP:BSTation:ENHanced: PCCPch:STATE.....	6.568	[SOURce<[1]2>:]BB:W3GPP:MSTation<[1]2 3 4>: DPCCh:HS:CQI:PLENgtH.....	6.584
[SOURce<[1]2>:]BB:W3GPP:BSTation:OCNS: MODE.....	6.543	[SOURce<[1]2>:]BB:W3GPP:MSTation<[1]2 3 4>: DPCCh:HS:HAPattern.....	6.585
[SOURce<[1]2>:]BB:W3GPP:BSTation:OCNS: STATE.....	6.543	[SOURce<[1]2>:]BB:W3GPP:MSTation<[1]2 3 4>: DPCCh:HS:POAC.....	6.585
[SOURce<[1]2>:]BB:W3GPP:BSTation:PRESet.....	6.544	[SOURce<[1]2>:]BB:W3GPP:MSTation<[1]2 3 4>: DPCCh:HS:PONA.....	6.586
[SOURce<[1]2>:]BB:W3GPP:BSTation1: CHANnel12:HSDPa:BPAyload.....	6.527	[SOURce<[1]2>:]BB:W3GPP:MSTation<[1]2 3 4>: DPCCh:HS:POWer.....	6.586
[SOURce<[1]2>:]BB:W3GPP:BSTation1: CHANnel12:HSDPa:HARQ:LENGth?.....	6.528	[SOURce<[1]2>:]BB:W3GPP:MSTation<[1]2 3 4>: DPCCh:HS:SDElay.....	6.586
[SOURce<[1]2>:]BB:W3GPP:BSTation1: CHANnel12:HSDPa:HSET.....	6.528	[SOURce<[1]2>:]BB:W3GPP:MSTation<[1]2 3 4>: DPCCh:HS:STATE.....	6.587
[SOURce<[1]2>:]BB:W3GPP:BSTation1: CHANnel12:HSDPa:NAIB?.....	6.529	[SOURce<[1]2>:]BB:W3GPP:MSTation<[1]2 3 4>: DPCCh:HS:TTIDistance.....	6.587
[SOURce<[1]2>:]BB:W3GPP:BSTation1: CHANnel12:HSDPa:PRSR?.....	6.530	[SOURce<[1]2>:]BB:W3GPP:MSTation<[1]2 3 4>: DPCCh:POWer.....	6.587
[SOURce<[1]2>:]BB:W3GPP:BSTation1: CHANnel12:HSDPa:PSBS?.....	6.530	[SOURce<[1]2>:]BB:W3GPP:MSTation<[1]2 3 4>: DPCCh:SFORmat.....	6.587
[SOURce<[1]2>:]BB:W3GPP:BSTation1: CHANnel12:HSDPa:RVParameter.....	6.531	[SOURce<[1]2>:]BB:W3GPP:MSTation<[1]2 3 4>: DPCCh:TFCI.....	6.588
[SOURce<[1]2>:]BB:W3GPP:BSTation1: CHANnel12:HSDPa:SFORmat.....	6.531	[SOURce<[1]2>:]BB:W3GPP:MSTation<[1]2 3 4>: DPCCh:TFCI:STATE.....	6.588
[SOURce<[1]2>:]BB:W3GPP:BSTation1: CHANnel12:HSDPa:UEID.....	6.536	[SOURce<[1]2>:]BB:W3GPP:MSTation<[1]2 3 4>: DPCCh:TOFFset?.....	6.588
[SOURce<[1]2>:]BB:W3GPP:CLIPping:LEvel.....	6.486	[SOURce<[1]2>:]BB:W3GPP:MSTation<[1]2 3 4>: DPCCh:TPC:DATA.....	6.589
[SOURce<[1]2>:]BB:W3GPP:CLIPping:MODE.....	6.486	[SOURce<[1]2>:]BB:W3GPP:MSTation<[1]2 3 4>: DPCCh:TPC:DATA:DSElect.....	6.589
[SOURce<[1]2>:]BB:W3GPP:CLIPping:STATE.....	6.487	[SOURce<[1]2>:]BB:W3GPP:MSTation<[1]2 3 4>: DPCCh:TPC:DATA:PATtern.....	6.590
[SOURce<[1]2>:]BB:W3GPP:CLOCK:MODE.....	6.487	[SOURce<[1]2>:]BB:W3GPP:MSTation<[1]2 3 4>: DPCCh:TPC:MISSe.....	6.590
[SOURce<[1]2>:]BB:W3GPP:CLOCK:MULTiplier.....	6.488	[SOURce<[1]2>:]BB:W3GPP:MSTation<[1]2 3 4>: DPCCh:TPC:READ.....	6.591
[SOURce<[1]2>:]BB:W3GPP:CLOCK:SOURce.....	6.488	[SOURce<[1]2>:]BB:W3GPP:MSTation<[1]2 3 4>: DPDCh:FCIO.....	6.582
[SOURce<[1]2>:]BB:W3GPP:COPIY:COFFset.....	6.489	[SOURce<[1]2>:]BB:W3GPP:MSTation<[1]2 3 4>: DPDCh:ORATe.....	6.582
[SOURce<[1]2>:]BB:W3GPP:COPIY:DESTination.....	6.489	[SOURce<[1]2>:]BB:W3GPP:MSTation<[1]2 3 4>: DPDCh:POWer.....	6.582
[SOURce<[1]2>:]BB:W3GPP:COPIY:EXECute.....	6.489	[SOURce<[1]2>:]BB:W3GPP:MSTation<[1]2 3 4>: DPDCh:STATE.....	6.583
[SOURce<[1]2>:]BB:W3GPP:COPIY:SOURce.....	6.490	[SOURce<[1]2>:]BB:W3GPP:MSTation<[1]2 3 4>: HSUPa:CHANnel<[1]...4>:DPDCh:DATA.....	6.599
[SOURce<[1]2>:]BB:W3GPP:CRATe?.....	6.490	[SOURce<[1]2>:]BB:W3GPP:MSTation<[1]2 3 4>: HSUPa:CHANnel<[1]...4>:DPDCh:E:CCODE?.....	6.598
[SOURce<[1]2>:]BB:W3GPP:CRATe:VARiation.....	6.491	[SOURce<[1]2>:]BB:W3GPP:MSTation<[1]2 3 4>: HSUPa:CHANnel<[1]...4>:DPDCh:E:SRATe?.....	6.602
[SOURce<[1]2>:]BB:W3GPP:FILETer:PARAmeter: APCO25.....	6.491	[SOURce<[1]2>:]BB:W3GPP:MSTation<[1]2 3 4>: HSUPa:CHANnel<[1]...4>h:E:DATA:DSElect.....	6.599
[SOURce<[1]2>:]BB:W3GPP:FILETer:PARAmeter: COSine.....	6.491	[SOURce<[1]2>:]BB:W3GPP:MSTation<[1]2 3 4>: HSUPa:DPCCCh:E:DTX:PATtern.....	6.591
[SOURce<[1]2>:]BB:W3GPP:FILETer:PARAmeter: GAUSSs.....	6.492	[SOURce<[1]2>:]BB:W3GPP:MSTation<[1]2 3 4>: HSUPa:DPCCCh:E:DTX:STATE.....	6.592
[SOURce<[1]2>:]BB:W3GPP:FILETer:PARAmeter: RCOSine.....	6.492	[SOURce<[1]2>:]BB:W3GPP:MSTation<[1]2 3 4>: HSUPa:DPCCCh:E:FRC:CHANnel.....	6.593
[SOURce<[1]2>:]BB:W3GPP:FILETer:PARAmeter: SPHase.....	6.492	[SOURce<[1]2>:]BB:W3GPP:MSTation<[1]2 3 4>: HSUPa:DPCCCh:E:FRC:CRATe.....	6.593
[SOURce<[1]2>:]BB:W3GPP:FILETer:TYPE.....	6.493	[SOURce<[1]2>:]BB:W3GPP:MSTation<[1]2 3 4>: HSUPa:DPCCCh:E:FRC:DERRor:BIT:LAYer.....	6.594
[SOURce<[1]2>:]BB:W3GPP:LINK.....	6.493	[SOURce<[1]2>:]BB:W3GPP:MSTation<[1]2 3 4>: HSUPa:DPCCCh:E:FRC:DERRor:BIT:RATE.....	6.594
[SOURce<[1]2>:]BB:W3GPP:MSTation<[1]2 3 4>: CHANnel<[1]...6>:DPDCh:CCODE?.....	6.575	[SOURce<[1]2>:]BB:W3GPP:MSTation<[1]2 3 4>: HSUPa:DPCCCh:E:FRC:DERRor:BLOCK:RATE.....	6.594
[SOURce<[1]2>:]BB:W3GPP:MSTation<[1]2 3 4>: CHANnel<[1]...6>:DPDCh:DATA.....	6.576	[SOURce<[1]2>:]BB:W3GPP:MSTation<[1]2 3 4>: HSUPa:DPCCCh:E:FRC:DERRor:BLOCK:STATE.....	6.595
[SOURce<[1]2>:]BB:W3GPP:MSTation<[1]2 3 4>: CHANnel<[1]...6>:DPDCh:DATA:DCCH.....	6.577		
[SOURce<[1]2>:]BB:W3GPP:MSTation<[1]2 3 4>: CHANnel<[1]...6>:DPDCh:DATA:DCCH:PATtern.....	6.578		
[SOURce<[1]2>:]BB:W3GPP:MSTation<[1]2 3 4>: CHANnel<[1]...6>:DPDCh:DCCH:DSElectt.....	6.578		
[SOURce<[1]2>:]BB:W3GPP:MSTation<[1]2 3 4>: CHANnel<[1]...6>:DPDCh:DSElectt.....	6.576		
[SOURce<[1]2>:]BB:W3GPP:MSTation<[1]2 3 4>: CHANnel<[1]...6>:DPDCh:PATtern.....	6.577		
[SOURce<[1]2>:]BB:W3GPP:MSTation<[1]2 3 4>: CHANnel<[1]...6>:DPDCh:SRATe?.....	6.579		
[SOURce<[1]2>:]BB:W3GPP:MSTation<[1]2 3 4>: DPCCh:CCODE?.....	6.583		
[SOURce<[1]2>:]BB:W3GPP:MSTation<[1]2 3 4>: DPCCh:FBI:PATtern.....	6.584		
[SOURce<[1]2>:]BB:W3GPP:MSTation<[1]2 3 4>: DPCCh:HS:CCODE?.....	6.584		

[SOURce<[1]2>:]BB:W3GPP:MSTation<[1]2 3 4>: HSUPa:DPCCCh:E:FRC:DTX:PATtern.....	6.595	[SOURce<[1]2>:]BB:W3GPP:MSTation<[1]2 3 4>: PCPCh:PPOWer:STEP.....	6.607
[SOURce<[1]2>:]BB:W3GPP:MSTation<[1]2 3 4>: HSUPa:DPCCCh:E:FRC:DTX:STAtE.....	6.595	[SOURce<[1]2>:]BB:W3GPP:MSTation<[1]2 3 4>: PCPCh:PREPetition.....	6.607
[SOURce<[1]2>:]BB:W3GPP:MSTation<[1]2 3 4>: HSUPa:DPCCCh:E:FRC:HARQ:PATtern<CH>.....	6.595	[SOURce<[1]2>:]BB:W3GPP:MSTation<[1]2 3 4>: PCPCh:SIGNature.....	6.608
[SOURce<[1]2>:]BB:W3GPP:MSTation<[1]2 3 4>: HSUPa:DPCCCh:E:FRC:HARQ:STAtE.....	6.596	[SOURce<[1]2>:]BB:W3GPP:MSTation<[1]2 3 4>: PCPCh:SRAtE.....	6.608
[SOURce<[1]2>:]BB:W3GPP:MSTation<[1]2 3 4>: HSUPa:DPCCCh:E:FRC:HPROcesses.....	6.596	[SOURce<[1]2>:]BB:W3GPP:MSTation<[1]2 3 4>: PCPCh:TFCI.....	6.608
[SOURce<[1]2>:]BB:W3GPP:MSTation<[1]2 3 4>: HSUPa:DPCCCh:E:FRC:MIBRate.....	6.596	[SOURce<[1]2>:]BB:W3GPP:MSTation<[1]2 3 4>: PCPCh:TIMing&DPOWer:MPARt?.....	6.609
[SOURce<[1]2>:]BB:W3GPP:MSTation<[1]2 3 4>: HSUPa:DPCCCh:E:FRC:PAYBits.....	6.597	[SOURce<[1]2>:]BB:W3GPP:MSTation<[1]2 3 4>: PCPCh:TIMing&DPOWer:PREAmble?.....	6.609
[SOURce<[1]2>:]BB:W3GPP:MSTation<[1]2 3 4>: HSUPa:DPCCCh:E:FRC:PCCOdes.....	6.597	[SOURce<[1]2>:]BB:W3GPP:MSTation<[1]2 3 4>: PCPCh:TIMing:SOFFset.....	6.609
[SOURce<[1]2>:]BB:W3GPP:MSTation<[1]2 3 4>: HSUPa:DPCCCh:E:FRC:STAtE.....	6.597	[SOURce<[1]2>:]BB:W3GPP:MSTation<[1]2 3 4>: PCPCh:TIMing:SPERiod.....	6.610
[SOURce<[1]2>:]BB:W3GPP:MSTation<[1]2 3 4>: HSUPa:DPCCCh:E:FRC:TTIBits.....	6.598	[SOURce<[1]2>:]BB:W3GPP:MSTation<[1]2 3 4>: PCPCh:TIMing:TIME:PREMp.....	6.610
[SOURce<[1]2>:]BB:W3GPP:MSTation<[1]2 3 4>: HSUPa:DPCCCh:E:FRC:TTIEdch.....	6.598	[SOURce<[1]2>:]BB:W3GPP:MSTation<[1]2 3 4>: PCPCh:TIMing:TIME:PREPre.....	6.610
[SOURce<[1]2>:]BB:W3GPP:MSTation<[1]2 3 4>: HSUPa:DPCCCh:E:HBIT.....	6.592	[SOURce<[1]2>:]BB:W3GPP:MSTation<[1]2 3 4>: PCPCh:TPC:DATA.....	6.611
[SOURce<[1]2>:]BB:W3GPP:MSTation<[1]2 3 4>: HSUPa:DPCCCh:E:POWer.....	6.592	[SOURce<[1]2>:]BB:W3GPP:MSTation<[1]2 3 4>: PCPCh:TPC:DATA:DSElect.....	6.611
[SOURce<[1]2>:]BB:W3GPP:MSTation<[1]2 3 4>: HSUPa:DPCCCh:E:RSNumber.....	6.592	[SOURce<[1]2>:]BB:W3GPP:MSTation<[1]2 3 4>: PCPCh:TPC:DATA:PATtern.....	6.612
[SOURce<[1]2>:]BB:W3GPP:MSTation<[1]2 3 4>: HSUPa:DPCCCh:E:STAtE.....	6.591	[SOURce<[1]2>:]BB:W3GPP:MSTation<[1]2 3 4>: PCPCh:TPC:READ.....	6.612
[SOURce<[1]2>:]BB:W3GPP:MSTation<[1]2 3 4>: HSUPa:DPCCCh:E:TFCI.....	6.593	[SOURce<[1]2>:]BB:W3GPP:MSTation<[1]2 3 4>: PRACH:CPOWer.....	6.613
[SOURce<[1]2>:]BB:W3GPP:MSTation<[1]2 3 4>: HSUPa:DPCCCh:E:TTIEdch.....	6.593	[SOURce<[1]2>:]BB:W3GPP:MSTation<[1]2 3 4>: PRACH:DATA.....	6.613
[SOURce<[1]2>:]BB:W3GPP:MSTation<[1]2 3 4>: HSUPa:DPDCh:E:DTX:PATtern.....	6.600	[SOURce<[1]2>:]BB:W3GPP:MSTation<[1]2 3 4>: PRACH:DATA:DSElect.....	6.614
[SOURce<[1]2>:]BB:W3GPP:MSTation<[1]2 3 4>: HSUPa:DPDCh:E:DTX:STAtE.....	6.600	[SOURce<[1]2>:]BB:W3GPP:MSTation<[1]2 3 4>: PRACH:DATA:PATtern.....	6.614
[SOURce<[1]2>:]BB:W3GPP:MSTation<[1]2 3 4>: HSUPa:DPDCh:E:FCIO.....	6.601	[SOURce<[1]2>:]BB:W3GPP:MSTation<[1]2 3 4>: PRACH:DPOWer.....	6.614
[SOURce<[1]2>:]BB:W3GPP:MSTation<[1]2 3 4>: HSUPa:DPDCh:E:ORAtE.....	6.601	[SOURce<[1]2>:]BB:W3GPP:MSTation<[1]2 3 4>: PRACH:MLENght.....	6.615
[SOURce<[1]2>:]BB:W3GPP:MSTation<[1]2 3 4>: HSUPa:DPDCh:E:POWer.....	6.601	[SOURce<[1]2>:]BB:W3GPP:MSTation<[1]2 3 4>: PRACH:PPOWer.....	6.615
[SOURce<[1]2>:]BB:W3GPP:MSTation<[1]2 3 4>: HSUPa:DPDCh:E:STAtE.....	6.602	[SOURce<[1]2>:]BB:W3GPP:MSTation<[1]2 3 4>: PRACH:PPOWer:STEP.....	6.615
[SOURce<[1]2>:]BB:W3GPP:MSTation<[1]2 3 4>: HSUPa:DPDCh:E:TTIEdch.....	6.602	[SOURce<[1]2>:]BB:W3GPP:MSTation<[1]2 3 4>: PRACH:PREPetition.....	6.616
[SOURce<[1]2>:]BB:W3GPP:MSTation<[1]2 3 4>: MODE.....	6.603	[SOURce<[1]2>:]BB:W3GPP:MSTation<[1]2 3 4>: PRACH:SFORmat.....	6.616
[SOURce<[1]2>:]BB:W3GPP:MSTation<[1]2 3 4>: PCPCh:CPOWer.....	6.604	[SOURce<[1]2>:]BB:W3GPP:MSTation<[1]2 3 4>: PRACH:SIGNature.....	6.616
[SOURce<[1]2>:]BB:W3GPP:MSTation<[1]2 3 4>: PCPCh:CPSFormat.....	6.604	[SOURce<[1]2>:]BB:W3GPP:MSTation<[1]2 3 4>: PRACH:SRAtE.....	6.617
[SOURce<[1]2>:]BB:W3GPP:MSTation<[1]2 3 4>: PCPCh:DATA.....	6.604	[SOURce<[1]2>:]BB:W3GPP:MSTation<[1]2 3 4>: PRACH:TFCI.....	6.617
[SOURce<[1]2>:]BB:W3GPP:MSTation<[1]2 3 4>: PCPCh:DATA:DSElect.....	6.605	[SOURce<[1]2>:]BB:W3GPP:MSTation<[1]2 3 4>: PRACH:TIMing&DPOWer:MPARt?.....	6.617
[SOURce<[1]2>:]BB:W3GPP:MSTation<[1]2 3 4>: PCPCh:DATA:PATtern.....	6.605	[SOURce<[1]2>:]BB:W3GPP:MSTation<[1]2 3 4>: PRACH:TIMing&DPOWer:MPARt:CONTRol?.....	6.618
[SOURce<[1]2>:]BB:W3GPP:MSTation<[1]2 3 4>: PCPCh:DPOWer.....	6.605	[SOURce<[1]2>:]BB:W3GPP:MSTation<[1]2 3 4>: PRACH:TIMing&DPOWer:MPARt:DATA?.....	6.618
[SOURce<[1]2>:]BB:W3GPP:MSTation<[1]2 3 4>: PCPCh:FBI:MODE.....	6.606	[SOURce<[1]2>:]BB:W3GPP:MSTation<[1]2 3 4>: PRACH:TIMing&DPOWer:PREAmble?.....	6.618
[SOURce<[1]2>:]BB:W3GPP:MSTation<[1]2 3 4>: PCPCh:FBI:PATtern.....	6.606	[SOURce<[1]2>:]BB:W3GPP:MSTation<[1]2 3 4>: PRACH:TIMing:SOFFset.....	6.619
[SOURce<[1]2>:]BB:W3GPP:MSTation<[1]2 3 4>: PCPCh:MLENght.....	6.606	[SOURce<[1]2>:]BB:W3GPP:MSTation<[1]2 3 4>: PRACH:TIMing:SPERiod.....	6.619
[SOURce<[1]2>:]BB:W3GPP:MSTation<[1]2 3 4>: PCPCh:PLENght.....	6.606	[SOURce<[1]2>:]BB:W3GPP:MSTation<[1]2 3 4>: PRACH:TIMing:TIME:PREMp.....	6.619
[SOURce<[1]2>:]BB:W3GPP:MSTation<[1]2 3 4>: PCPCh:PPOWer.....	6.607	[SOURce<[1]2>:]BB:W3GPP:MSTation<[1]2 3 4>: PRACH:TIMing:TIME:PREPre.....	6.620

[SOURce<[1]2>:]BB:W3GPP:MSTation<[1]2 3 4>: SCODE ..... 6.620	[SOURce<[1]2>:]BB:W3GPP:MSTation:ENHanced: DPDCh:DPControl:STEP:MANual ..... 6.631
[SOURce<[1]2>:]BB:W3GPP:MSTation<[1]2 3 4>: SCODE:MODE ..... 6.621	[SOURce<[1]2>:]BB:W3GPP:MSTation:ENHanced: DPDCh:INTerleaver2 ..... 6.631
[SOURce<[1]2>:]BB:W3GPP:MSTation<[1]2 3 4>: STATE ..... 6.621	[SOURce<[1]2>:]BB:W3GPP:MSTation:ENHanced: DPDCh:ORATE ..... 6.632
[SOURce<[1]2>:]BB:W3GPP:MSTation<2 3 4>: CMODE:METhod ..... 6.579	[SOURce<[1]2>:]BB:W3GPP:MSTation:ENHanced: DPDCh:TCHannel<0 1...6>:CCODing: INTerleaver[1] ..... 6.635
[SOURce<[1]2>:]BB:W3GPP:MSTation<2 3 4>: CMODE:PATTErn<[1]2>:TGD ..... 6.579	[SOURce<[1]2>:]BB:W3GPP:MSTation:ENHanced: DPDCh:TCHannel<0 1...6>:CRCSize ..... 6.632
[SOURce<[1]2>:]BB:W3GPP:MSTation<2 3 4>: CMODE:PATTErn<[1]2>:TGL<[1]2> ..... 6.580	[SOURce<[1]2>:]BB:W3GPP:MSTation:ENHanced: DPDCh:TCHannel<0 1...6>:DATA ..... 6.633
[SOURce<[1]2>:]BB:W3GPP:MSTation<2 3 4>: CMODE:PATTErn<[1]2>:TGPL ..... 6.580	[SOURce<[1]2>:]BB:W3GPP:MSTation:ENHanced: DPDCh:TCHannel<0 1...6>:DATA:DSElect ..... 6.634
[SOURce<[1]2>:]BB:W3GPP:MSTation<2 3 4>: CMODE:PATTErn<[1]2>:TGSN ..... 6.580	[SOURce<[1]2>:]BB:W3GPP:MSTation:ENHanced: DPDCh:TCHannel<0 1...6>:DATA:PATTErn ..... 6.633
[SOURce<[1]2>:]BB:W3GPP:MSTation<2 3 4>: CMODE:POFFset ..... 6.581	[SOURce<[1]2>:]BB:W3GPP:MSTation:ENHanced: DPDCh:TCHannel<0 1...6>:EPRotectioN ..... 6.634
[SOURce<[1]2>:]BB:W3GPP:MSTation<2 3 4>: CMODE:POMode ..... 6.581	[SOURce<[1]2>:]BB:W3GPP:MSTation:ENHanced: DPDCh:TCHannel<0 1...6>:RMATribute ..... 6.635
[SOURce<[1]2>:]BB:W3GPP:MSTation<2 3 4>: CMODE:STATE ..... 6.581	[SOURce<[1]2>:]BB:W3GPP:MSTation:ENHanced: DPDCh:TCHannel<0 1...6>:STATE ..... 6.636
[SOURce<[1]2>:]BB:W3GPP:MSTation<2 3 4>: TDElay:STEP ..... 6.621	[SOURce<[1]2>:]BB:W3GPP:MSTation:ENHanced: DPDCh:TCHannel<0 1...6>:TBCount ..... 6.636
[SOURce<[1]2>:]BB:W3GPP:MSTation:ADDITIONal: COUNT ..... 6.574	[SOURce<[1]2>:]BB:W3GPP:MSTation:ENHanced: DPDCh:TCHannel<0 1...6>:TBSize ..... 6.636
[SOURce<[1]2>:]BB:W3GPP:MSTation:ADDITIONal: POWER:OFFSet ..... 6.574	[SOURce<[1]2>:]BB:W3GPP:MSTation:ENHanced: DPDCh:TCHannel<0 1...6>:TTINterval ..... 6.637
[SOURce<[1]2>:]BB:W3GPP:MSTation:ADDITIONal: SCODE:STEP ..... 6.574	[SOURce<[1]2>:]BB:W3GPP:MSTation:ENHanced: PCPCh:CCODing:STATE ..... 6.637
[SOURce<[1]2>:]BB:W3GPP:MSTation:ADDITIONal: STATE ..... 6.575	[SOURce<[1]2>:]BB:W3GPP:MSTation:ENHanced: PCPCh:CCODing:TYPE ..... 6.638
[SOURce<[1]2>:]BB:W3GPP:MSTation:ADDITIONal: TDElay:STEP ..... 6.575	[SOURce<[1]2>:]BB:W3GPP:MSTation:ENHanced: PRACH:CCODing:STATE ..... 6.638
[SOURce<[1]2>:]BB:W3GPP:MSTation:ENHanced: DPDCh:BPFRame? ..... 6.623	[SOURce<[1]2>:]BB:W3GPP:MSTation:ENHanced: PRACH:CCODing:TYPE ..... 6.638
[SOURce<[1]2>:]BB:W3GPP:MSTation:ENHanced: DPDCh:CCODing:STATE ..... 6.624	[SOURce<[1]2>:]BB:W3GPP:MSTation:PRESet ..... 6.620
[SOURce<[1]2>:]BB:W3GPP:MSTation:ENHanced: DPDCh:CCODing:TYPE ..... 6.624	[SOURce<[1]2>:]BB:W3GPP:POWER:[TOTal] ..... 6.494
[SOURce<[1]2>:]BB:W3GPP:MSTation:ENHanced: DPDCh:CCODing:USER:CATalog? ..... 6.625	[SOURce<[1]2>:]BB:W3GPP:POWER:ADJust ..... 6.494
[SOURce<[1]2>:]BB:W3GPP:MSTation:ENHanced: DPDCh:CCODing:USER:DELeTe ..... 6.625	[SOURce<[1]2>:]BB:W3GPP:PPARameter:CRESt ..... 6.507
[SOURce<[1]2>:]BB:W3GPP:MSTation:ENHanced: DPDCh:CCODing:USER:LOAD ..... 6.626	[SOURce<[1]2>:]BB:W3GPP:PPARameter:DPCH: COUNT ..... 6.507
[SOURce<[1]2>:]BB:W3GPP:MSTation:ENHanced: DPDCh:CCODing:USER:STORed ..... 6.626	[SOURce<[1]2>:]BB:W3GPP:PPARameter:DPCH: SRATE ..... 6.508
[SOURce<[1]2>:]BB:W3GPP:MSTation:ENHanced: DPDCh:DERRor:BIT:LAYer ..... 6.627	[SOURce<[1]2>:]BB:W3GPP:PPARameter: EXECute ..... 6.508
[SOURce<[1]2>:]BB:W3GPP:MSTation:ENHanced: DPDCh:DERRor:BIT:RATE ..... 6.627	[SOURce<[1]2>:]BB:W3GPP:PPARameter:SCCPch: SRATE ..... 6.508
[SOURce<[1]2>:]BB:W3GPP:MSTation:ENHanced: DPDCh:DERRor:BIT:STATE ..... 6.627	[SOURce<[1]2>:]BB:W3GPP:PPARameter:SCCPch: STATE ..... 6.509
[SOURce<[1]2>:]BB:W3GPP:MSTation:ENHanced: DPDCh:DERRor:BLOCK:RATE ..... 6.628	[SOURce<[1]2>:]BB:W3GPP:PPARameter: SCHannels ..... 6.509
[SOURce<[1]2>:]BB:W3GPP:MSTation:ENHanced: DPDCh:DERRor:BLOCK:STATE ..... 6.628	[SOURce<[1]2>:]BB:W3GPP:PRESet ..... 6.494
[SOURce<[1]2>:]BB:W3GPP:MSTation:ENHanced: DPDCh:DPControl:[POWER] ..... 6.629	[SOURce<[1]2>:]BB:W3GPP:SEQuence ..... 6.495
[SOURce<[1]2>:]BB:W3GPP:MSTation:ENHanced: DPDCh:DPControl:DIRectioN ..... 6.628	[SOURce<[1]2>:]BB:W3GPP:SETTING:CATalog? ..... 6.496
[SOURce<[1]2>:]BB:W3GPP:MSTation:ENHanced: DPDCh:DPControl:MODE ..... 6.629	[SOURce<[1]2>:]BB:W3GPP:SETTING:DELeTe ..... 6.496
[SOURce<[1]2>:]BB:W3GPP:MSTation:ENHanced: DPDCh:DPControl:RANGe:DOWN ..... 6.629	[SOURce<[1]2>:]BB:W3GPP:SETTING:LOAD ..... 6.496
[SOURce<[1]2>:]BB:W3GPP:MSTation:ENHanced: DPDCh:DPControl:RANGe:UP ..... 6.630	[SOURce<[1]2>:]BB:W3GPP:SETTING:STORe ..... 6.497
[SOURce<[1]2>:]BB:W3GPP:MSTation:ENHanced: DPDCh:DPControl:STATE ..... 6.630	[SOURce<[1]2>:]BB:W3GPP:SETTING:TMOdel: BSTation ..... 6.510
[SOURce<[1]2>:]BB:W3GPP:MSTation:ENHanced: DPDCh:DPControl:STEP:[EXTernal] ..... 6.630	[SOURce<[1]2>:]BB:W3GPP:SETTING:TMOdel: BSTation:CATalog? ..... 6.510
	[SOURce<[1]2>:]BB:W3GPP:SETTING:TMOdel: MSTation ..... 6.511
	[SOURce<[1]2>:]BB:W3GPP:SETTING:TMOdel: MSTation:CATalog? ..... 6.511
	[SOURce<[1]2>:]BB:W3GPP:SLENgth ..... 6.497
	[SOURce<[1]2>:]BB:W3GPP:STATE ..... 6.497
	[SOURce<[1]2>:]BB:W3GPP:TRIGger [:EXTernal<[1]2>]:DElay ..... 6.499
	[SOURce<[1]2>:]BB:W3GPP:TRIGger [:EXTernal<[1]2>]:INHibit ..... 6.499

[SOURce<[1]2>:JBB:W3GPP:TRIGger:ARM: EXECute .....	6.498	[SOURce<[1]2>:JBB:WIMax:AOFDM[:ZONE<0...7>]: BURSt<0...63>:UIUC .....	6.420
[SOURce<[1]2>:JBB:W3GPP:TRIGger:EXECute .....	6.498	[SOURce<[1]2>:JBB:WIMax:AOFDM[:ZONE<0...7>]: BURSt<0...63>:ULMap:AMODE .....	6.420
[SOURce<[1]2>:JBB:W3GPP:TRIGger: OBASband:INHibit .....	6.500	[SOURce<[1]2>:JBB:WIMax:AOFDM[:ZONE<0...7>]: BURSt<0...63>:ULMap:ATIME .....	6.420
[SOURce<[1]2>:JBB:W3GPP:TRIGger:OBASband: DElay .....	6.499	[SOURce<[1]2>:JBB:WIMax:AOFDM[:ZONE<0...7>]: BURSt<0...63>:CCODing:FEC .....	6.409
[SOURce<[1]2>:JBB:W3GPP:TRIGger: OUTPut<[1...4>:DElay .....	6.501	[SOURce<[1]2>:JBB:WIMax:AOFDM[:ZONE<0...7>]: BURSt<0...63>:CCODing:INTerleaver .....	6.409
[SOURce<[1]2>:JBB:W3GPP:TRIGger: OUTPut<[1...4>:DElay:FIXed .....	6.501	[SOURce<[1]2>:JBB:WIMax:AOFDM[:ZONE<0...7>]: BURSt<0...63>:CCODing:MODE .....	6.410
[SOURce<[1]2>:JBB:W3GPP:TRIGger: OUTPut<[1...4>:DElay:MAXimum? .....	6.501	[SOURce<[1]2>:JBB:WIMax:AOFDM[:ZONE<0...7>]: BURSt<0...63>:CCODing:RANDomizer .....	6.410
[SOURce<[1]2>:JBB:W3GPP:TRIGger: OUTPut<[1...4>:DElay:MINimum? .....	6.502	[SOURce<[1]2>:JBB:WIMax:AOFDM[:ZONE<0...7>]: BURSt<0...63>:CCODing:REPCoding .....	6.410
[SOURce<[1]2>:JBB:W3GPP:TRIGger: OUTPut<[1...4>:MODE .....	6.500	[SOURce<[1]2>:JBB:WIMax:AOFDM[:ZONE<0...7>]: DLMap:BSID .....	6.421
[SOURce<[1]2>:JBB:W3GPP:TRIGger: OUTPut<[1...4>:OFFTime .....	6.502	[SOURce<[1]2>:JBB:WIMax:AOFDM[:ZONE<0...7>]: DLMap:DATA:DCD[:COUNT] .....	6.421
[SOURce<[1]2>:JBB:W3GPP:TRIGger: OUTPut<[1...4>:ONTime .....	6.502	[SOURce<[1]2>:JBB:WIMax:AOFDM[:ZONE<0...7>]: DLMap:FNOFFset .....	6.422
[SOURce<[1]2>:JBB:W3GPP:TRIGger: OUTPut<[1...4>:PERiod .....	6.503	[SOURce<[1]2>:JBB:WIMax:AOFDM[:ZONE<0...7>]: DLMap:MODE .....	6.422
[SOURce<[1]2>:JBB:W3GPP:TRIGger:RMODE? .....	6.503	[SOURce<[1]2>:JBB:WIMax:AOFDM[:ZONE<0...7>]: DLMap:REPCoding .....	6.422
[SOURce<[1]2>:JBB:W3GPP:TRIGger:SLENgth .....	6.504	[SOURce<[1]2>:JBB:WIMax:AOFDM: BURSt<0...7>: MAC: CRC: STATe .....	6.414
[SOURce<[1]2>:JBB:W3GPP:TRIGger:SLUNit .....	6.504	[SOURce<[1]2>:JBB:WIMax:AOFDM: BURSt<0...7>: MAC: EKS .....	6.414
[SOURce<[1]2>:JBB:W3GPP:TRIGger:SOURce .....	6.505	[SOURce<[1]2>:JBB:WIMax:AOFDM: BURSt<0...7>: MAC: ENCRypted: STATe .....	6.415
[SOURce<[1]2>:JBB:W3GPP:WAVeform:CREate .....	6.505	[SOURce<[1]2>:JBB:WIMax:AOFDM: BURSt<0...7>: MAC: STATe .....	6.415
[SOURce<[1]2>:JBB:WIMax:AOFDM[:ZONE<0...7>]: SUBChannel<0...5>:MAP .....	6.426	[SOURce<[1]2>:JBB:WIMax:AOFDM: BURSt<0...7>: MAC: TYPE .....	6.415
[SOURce<[1]2>:JBB:WIMax:AOFDM[:ZONE<0...7>]: SUBChannel<n>:MODE .....	6.426	[SOURce<[1]2>:JBB:WIMax:AOFDM: BW .....	6.404
[SOURce<[1]2>:JBB:WIMax:AOFDM[:ZONE<0...7>]: SUBChannel<n>:PATtern .....	6.426	[SOURce<[1]2>:JBB:WIMax:AOFDM: FBANd .....	6.405
[SOURce<[1]2>:JBB:WIMax:AOFDM[:ZONE<0...7>]: TYPE .....	6.424, 6.428	[SOURce<[1]2>:JBB:WIMax:AOFDM: FFT .....	6.406
[SOURce<[1]2>:JBB:WIMax:AOFDM[:ZONE<0...7>]: UCD .....	6.428	[SOURce<[1]2>:JBB:WIMax:AOFDM: IDCell .....	6.406
[SOURce<[1]2>:JBB:WIMax:AOFDM[:ZONE<0...7>]: ULMap:CREate .....	6.428	[SOURce<[1]2>:JBB:WIMax:AOFDM: N .....	6.406
[SOURce<[1]2>:JBB:WIMax:AOFDM[:ZONE<0...7>]: BURSt[:COUNT] .....	6.409	[SOURce<[1]2>:JBB:WIMax:AOFDM: POWer: REFerence .....	6.407
[SOURce<[1]2>:JBB:WIMax:AOFDM[:ZONE<0...7>]: BURSt<0...63>:DATA .....	6.411	[SOURce<[1]2>:JBB:WIMax:AOFDM: PREamble: INDex .....	6.407
[SOURce<[1]2>:JBB:WIMax:AOFDM[:ZONE<0...7>]: BURSt<0...63>:DSElect .....	6.412	[SOURce<[1]2>:JBB:WIMax:AOFDM: SRATe .....	6.408
[SOURce<[1]2>:JBB:WIMax:AOFDM[:ZONE<0...7>]: BURSt<0...63>:DATA:PATtern .....	6.413	[SOURce<[1]2>:JBB:WIMax:AOFDM: TGTB .....	6.409
[SOURce<[1]2>:JBB:WIMax:AOFDM[:ZONE<0...7>]: BURSt<0...63>:DIUC .....	6.413	[SOURce<[1]2>:JBB:WIMax:AOFDM: ZONE<0...7>: FCH:MODE .....	6.423
[SOURce<[1]2>:JBB:WIMax:AOFDM[:ZONE<0...7>]: BURSt<0...63>:FORMat .....	6.413	[SOURce<[1]2>:JBB:WIMax:AOFDM: ZONE<0...7>: NUMBER .....	6.423
[SOURce<[1]2>:JBB:WIMax:AOFDM[:ZONE<0...7>]: BURSt<0...63>:POWer .....	6.417	[SOURce<[1]2>:JBB:WIMax:AOFDM: ZONE<0...7>: PERMbase .....	6.424
[SOURce<[1]2>:JBB:WIMax:AOFDM[:ZONE<0...7>]: BURSt<0...63>:RANGing:ACODE .....	6.417	[SOURce<[1]2>:JBB:WIMax:AOFDM: ZONE<0...7>: PRBSid .....	6.424
[SOURce<[1]2>:JBB:WIMax:AOFDM[:ZONE<0...7>]: BURSt<0...63>:RANGing:OPPortunity:SCGCount .....	6.418	[SOURce<[1]2>:JBB:WIMax:AOFDM: ZONE<0...7>: SCARrier:RANDomizer .....	6.424
[SOURce<[1]2>:JBB:WIMax:AOFDM[:ZONE<0...7>]: BURSt<0...63>:RANGing:OPPortunity:SIZE .....	6.417	[SOURce<[1]2>:JBB:WIMax:AOFDM: ZONE<0...7>: SEGment .....	6.425
[SOURce<[1]2>:JBB:WIMax:AOFDM[:ZONE<0...7>]: BURSt<0...63>:SLOT:COUNT .....	6.418	[SOURce<[1]2>:JBB:WIMax:AOFDM: ZONE<0...7>: STC: ANTenna .....	6.425
[SOURce<[1]2>:JBB:WIMax:AOFDM[:ZONE<0...7>]: BURSt<0...63>:SYMBOL[:COUNT] .....	6.419	[SOURce<[1]2>:JBB:WIMax:AOFDM: ZONE<0...7>: STC: MODE .....	6.425
[SOURce<[1]2>:JBB:WIMax:AOFDM[:ZONE<0...7>]: BURSt<0...63>:TYPE .....	6.419	[SOURce<[1]2>:JBB:WIMax:AOFDM: ZONE<0...7>: SYMBOL[:COUNT] .....	6.427
		[SOURce<[1]2>:JBB:WIMax:AOFDM: ZONE<0...7>: SYMBOL[:COUNT]:AUTO .....	6.427
		[SOURce<[1]2>:JBB:WIMax:AOFDM: ZONE<0...7>: SYMBOL:OFFSet .....	6.427
		[SOURce<[1]2>:JBB:WIMax:AOFDM: ZONE<0...7>: BURSt<0...63>:OFFet:SUBChannel .....	6.416

[SOURce<[1]2>:]BB:WIMax:AOFDM:ZONE<0..7>: BURSt<0..63>:OFFet:SYMBOL	6.416	[SOURce<[1]2>:]BB:WIMax:OFDM:BURSt<0..7>: MAC:STATe	6.436
[SOURce<[1]2>:]BB:WIMax:AOFDM:ZONE<0..7>: BURSt<0..63>:SUBChannel[:COUNT]	6.419	[SOURce<[1]2>:]BB:WIMax:OFDM:BURSt<0..7>: MAC:TYPE	6.436
[SOURce<[1]2>:]BB:WIMax:AOFDM:ZONE<0..7>: BURSt<0..63>:CONFLict[:STATe]	6.411	[SOURce<[1]2>:]BB:WIMax:OFDM:BURSt<0..7>: PREAmble:MODE	6.437
[SOURce<[1]2>:]BB:WIMax:AOFDM:ZONE:COUNT	6.421	[SOURce<[1]2>:]BB:WIMax:OFDM:BURSt<0..7>: SYMBOL[:COUNT]	6.437
[SOURce<[1]2>:]BB:WIMax:CLIPping:LEVel	6.380	[SOURce<[1]2>:]BB:WIMax:OFDM:BURSt: CCODing:STATe	6.431
[SOURce<[1]2>:]BB:WIMax:CLIPping:MODE	6.380	[SOURce<[1]2>:]BB:WIMax:OFDM:BW	6.439
[SOURce<[1]2>:]BB:WIMax:CLIPping:STATe	6.381	[SOURce<[1]2>:]BB:WIMax:OFDM:FBAND	6.440
[SOURce<[1]2>:]BB:WIMax:CLOCK:MODE	6.381	[SOURce<[1]2>:]BB:WIMax:OFDM:FCH:STATe	6.444
[SOURce<[1]2>:]BB:WIMax:CLOCK:MULTIplier	6.381	[SOURce<[1]2>:]BB:WIMax:OFDM:FCH:CCC	6.440
[SOURce<[1]2>:]BB:WIMax:CLOCK:SOURce	6.382	[SOURce<[1]2>:]BB:WIMax:OFDM:FCH:DATA	6.441
[SOURce<[1]2>:]BB:WIMax:DUPLexing	6.382	[SOURce<[1]2>:]BB:WIMax:OFDM:FCH:DATA: DSElect	6.441
[SOURce<[1]2>:]BB:WIMax:FiLTer:OPTimization	6.383	[SOURce<[1]2>:]BB:WIMax:OFDM:FCH:DATA: PATTern	6.442
[SOURce<[1]2>:]BB:WIMax:FiLTer:PARAmeter: APCO25	6.383	[SOURce<[1]2>:]BB:WIMax:OFDM:FCH:FNOFFset	6.442
[SOURce<[1]2>:]BB:WIMax:FiLTer:PARAmeter: COSine	6.383	[SOURce<[1]2>:]BB:WIMax:OFDM:FCH:MODE	6.443
[SOURce<[1]2>:]BB:WIMax:FiLTer:PARAmeter: COSine:COFS	6.384	[SOURce<[1]2>:]BB:WIMax:OFDM:FFT	6.444
[SOURce<[1]2>:]BB:WIMax:FiLTer:PARAmeter: GAUSS	6.384	[SOURce<[1]2>:]BB:WIMax:OFDM:FRAME [:NUMBER]	6.445
[SOURce<[1]2>:]BB:WIMax:FiLTer:PARAmeter: PGAuss	6.384	[SOURce<[1]2>:]BB:WIMax:OFDM:FRAME: PREDEfined	6.445
[SOURce<[1]2>:]BB:WIMax:FiLTer:PARAmeter: RCOSine	6.384	[SOURce<[1]2>:]BB:WIMax:OFDM:N	6.446
[SOURce<[1]2>:]BB:WIMax:FiLTer:PARAmeter: SPHase	6.385	[SOURce<[1]2>:]BB:WIMax:OFDM:POWER: REFERENCE	6.446
[SOURce<[1]2>:]BB:WIMax:FiLTer:TYPE	6.385	[SOURce<[1]2>:]BB:WIMax:OFDM:PREAmble: MODE	6.446
[SOURce<[1]2>:]BB:WIMax:FRAME:BURSt:DElay	6.385	[SOURce<[1]2>:]BB:WIMax:OFDM:SRATe	6.447
[SOURce<[1]2>:]BB:WIMax:FRAME:TIME	6.386	[SOURce<[1]2>:]BB:WIMax:OFDM:SUBChannel [:COUNT]	6.447
[SOURce<[1]2>:]BB:WIMax:FRAME:TIME:USER	6.386	[SOURce<[1]2>:]BB:WIMax:OFDM:SUBChannel: INDEX	6.447
[SOURce<[1]2>:]BB:WIMax:LINK	6.386	[SOURce<[1]2>:]BB:WIMax:OFDM:TGTB	6.448
[SOURce<[1]2>:]BB:WIMax:MODE	6.387	[SOURce<[1]2>:]BB:WIMax:OFDM:UCD	6.448
[SOURce<[1]2>:]BB:WIMax:OFDM:BSID	6.431	[SOURce<[1]2>:]BB:WIMax:OFDM:ULMap: CREate	6.448
[SOURce<[1]2>:]BB:WIMax:OFDM :BURSt[:COUNT]	6.431	[SOURce<[1]2>:]BB:WIMax:PRESet	6.388
[SOURce<[1]2>:]BB:WIMax:OFDM:BURSt<0..63>: DATA	6.432	[SOURce<[1]2>:]BB:WIMax:SEQuence	6.388
[SOURce<[1]2>:]BB:WIMax:OFDM:BURSt<0..63>: DATA:DSElect	6.432	[SOURce<[1]2>:]BB:WIMax:SETTing:CATalog?	6.389
[SOURce<[1]2>:]BB:WIMax:OFDM:BURSt<0..63>: DATA:PATTern	6.433	[SOURce<[1]2>:]BB:WIMax:SETTing:DElete	6.389
[SOURce<[1]2>:]BB:WIMax:OFDM:BURSt<0..63>: DIUC	6.433	[SOURce<[1]2>:]BB:WIMax:SETTing:LOAD	6.389
[SOURce<[1]2>:]BB:WIMax:OFDM:BURSt<0..63>: DLEngh	6.433	[SOURce<[1]2>:]BB:WIMax:SETTing:STORe	6.390
[SOURce<[1]2>:]BB:WIMax:OFDM:BURSt<0..63>: FORMat	6.434	[SOURce<[1]2>:]BB:WIMax:SLEngh	6.390
[SOURce<[1]2>:]BB:WIMax:OFDM:BURSt<0..63>: GAP	6.434	[SOURce<[1]2>:]BB:WIMax:SRATe:VARiation	6.390
[SOURce<[1]2>:]BB:WIMax:OFDM:BURSt<0..63>: MIDAmble	6.436	[SOURce<[1]2>:]BB:WIMax:STATe	6.391
[SOURce<[1]2>:]BB:WIMax:OFDM:BURSt<0..63>: POWER	6.437	[SOURce<[1]2>:]BB:WIMax:SUBFrame:TIME	6.391
[SOURce<[1]2>:]BB:WIMax:OFDM:BURSt<0..63>: TYPE	6.438	[SOURce<[1]2>:]BB:WIMax:TRIGger [:EXtErnal<[1]2>]:DElay	6.393
[SOURce<[1]2>:]BB:WIMax:OFDM:BURSt<0..63>: UIUC	6.438	[SOURce<[1]2>:]BB:WIMax:TRIGger [:EXtErnal<[1]2>]:INHibit	6.393
[SOURce<[1]2>:]BB:WIMax:OFDM:BURSt<0..63>: ULMap:AMODE	6.438	[SOURce<[1]2>:]BB:WIMax:TRIGger:ARM: EXECute	6.392
[SOURce<[1]2>:]BB:WIMax:OFDM:BURSt<0..63>: ULMap:ATIME	6.439	[SOURce<[1]2>:]BB:WIMax:TRIGger:EXECute	6.392
[SOURce<[1]2>:]BB:WIMax:OFDM:BURSt<0..7>: MAC:CID	6.434	[SOURce<[1]2>:]BB:WIMax:TRIGger:OBASband: INHibit	6.394
[SOURce<[1]2>:]BB:WIMax:OFDM:BURSt<0..7>: MAC:CRc:STATe	6.435	[SOURce<[1]2>:]BB:WIMax:TRIGger:OBASband: DElay	6.393
[SOURce<[1]2>:]BB:WIMax:OFDM:BURSt<0..7>: MAC:EKS	6.435	[SOURce<[1]2>:]BB:WIMax:TRIGger: OUTPut<[1]..4>:DElay	6.394
[SOURce<[1]2>:]BB:WIMax:OFDM:BURSt<0..7>: MAC:ENCRypted:STATe	6.435	[SOURce<[1]2>:]BB:WIMax:TRIGger: OUTPut<[1]..4>:DElay:FiXed	6.394
		[SOURce<[1]2>:]BB:WIMax:TRIGger: OUTPut<[1]..4>:DElay:MAXimum?	6.395
		[SOURce<[1]2>:]BB:WIMax:TRIGger: OUTPut<[1]..4>:DElay:MINimum?	6.395
		[SOURce<[1]2>:]BB:WIMax:TRIGger: OUTPut<[1]..4>:FOFFset	6.395
		[SOURce<[1]2>:]BB:WIMax:TRIGger: OUTPut<[1]..4>:MODE	6.396

[SOURce<[1]2>:]BB:WIMax:TRIGger: OUTPut<[1]...4>:OFFTime .....	6.396	[SOURce<[1]2>:]BB:WLAN:PSDU:MAC: FCSequence:STATe .....	6.479
[SOURce<[1]2>:]BB:WIMax:TRIGger: OUTPut<[1]...4>:ONTime .....	6.397	[SOURce<[1]2>:]BB:WLAN:PSDU:MAC: MODulation .....	6.482
[SOURce<[1]2>:]BB:WIMax:TRIGger: OUTPut<[1]...4>:PULSe:DIVider .....	6.397	[SOURce<[1]2>:]BB:WLAN:PSDU:MAC:SCONtrol: FRAGment:INCRement .....	6.480
[SOURce<[1]2>:]BB:WIMax:TRIGger: OUTPut<[1]...4>:FREQuency? .....	6.398	[SOURce<[1]2>:]BB:WLAN:PSDU:MAC:SCONtrol: FRAGment:START .....	6.480
[SOURce<[1]2>:]BB:WIMax:TRIGger: OUTPut<[1]...4>:ROFFset .....	6.398	[SOURce<[1]2>:]BB:WLAN:PSDU:MAC:SCONtrol: SEQuence:INCRement .....	6.481
[SOURce<[1]2>:]BB:WIMax:TRIGger: OUTPut<[1]...4>:PATtern .....	6.397	[SOURce<[1]2>:]BB:WLAN:PSDU:MAC:SCONtrol: SEQuence:START .....	6.481
[SOURce<[1]2>:]BB:WIMax:TRIGger:SLENgth .....	6.399	[SOURce<[1]2>:]BB:WLAN:PSDU:MAC:SCONtrol: STATe .....	6.481
[SOURce<[1]2>:]BB:WIMax:TRIGger:SLUNit .....	6.400	[SOURce<[1]2>:]BB:WLAN:PSDU:MAC:STATe .....	6.482
[SOURce<[1]2>:]BB:WIMax:TRIGger:SOURce .....	6.399	[SOURce<[1]2>:]BB:WLAN:PSDU:SCOUNt .....	6.482
[SOURce<[1]2>:]BB:WIMax:WAVeform:CREate .....	6.400	[SOURce<[1]2>:]BB:WLAN:SCRambler:MODE .....	6.459
[SOURce<[1]2>:]BB:WLAN:CLIPping:LEVel .....	6.451	[SOURce<[1]2>:]BB:WLAN:SCRambler:PATtern .....	6.459
[SOURce<[1]2>:]BB:WLAN:CLIPping:MODE .....	6.451	[SOURce<[1]2>:]BB:WLAN:SEQuence .....	6.460
[SOURce<[1]2>:]BB:WLAN:CLIPping:STATe .....	6.452	[SOURce<[1]2>:]BB:WLAN:SERVice:PATtern .....	6.460
[SOURce<[1]2>:]BB:WLAN:CLOCK:MODE .....	6.452	[SOURce<[1]2>:]BB:WLAN:SETTing:CATalog? .....	6.461
[SOURce<[1]2>:]BB:WLAN:CLOCK:MULTiplier .....	6.452	[SOURce<[1]2>:]BB:WLAN:SETTing:DELeTe .....	6.461
[SOURce<[1]2>:]BB:WLAN:CLOCK:SOURce .....	6.453	[SOURce<[1]2>:]BB:WLAN:SETTing:LOAD .....	6.461
[SOURce<[1]2>:]BB:WLAN:CRATe:VARiatiOn .....	6.453	[SOURce<[1]2>:]BB:WLAN:SETTing:STORE .....	6.462
[SOURce<[1]2>:]BB:WLAN:FILTer:PARAmeter: APCO25 .....	6.454	[SOURce<[1]2>:]BB:WLAN:SLENgth .....	6.462
[SOURce<[1]2>:]BB:WLAN:FILTer:PARAmeter: COSine .....	6.454	[SOURce<[1]2>:]BB:WLAN:SMODE .....	6.462
[SOURce<[1]2>:]BB:WLAN:FILTer:PARAmeter: GAUSS .....	6.455	[SOURce<[1]2>:]BB:WLAN:STANdard .....	6.463
[SOURce<[1]2>:]BB:WLAN:FILTer:PARAmeter: PGAuss .....	6.455	[SOURce<[1]2>:]BB:WLAN:STATe .....	6.463
[SOURce<[1]2>:]BB:WLAN:FILTer:PARAmeter: RCOSine .....	6.455	[SOURce<[1]2>:]BB:WLAN:SUBFrame:TIME .....	6.464
[SOURce<[1]2>:]BB:WLAN:FILTer:PARAmeter: SPHase .....	6.455	[SOURce<[1]2>:]BB:WLAN:TRIGger [:EXtErnal<[1]2>]:DELay .....	6.465
[SOURce<[1]2>:]BB:WLAN:FILTer:TYPE .....	6.456	[SOURce<[1]2>:]BB:WLAN:TRIGger [:EXtErnal<[1]2>]:INHibit .....	6.466
[SOURce<[1]2>:]BB:WLAN:MODE .....	6.457	[SOURce<[1]2>:]BB:WLAN:TRIGger:ARM:EXECute .....	6.464
[SOURce<[1]2>:]BB:WLAN:PLCP:FORMat .....	6.457	[SOURce<[1]2>:]BB:WLAN:TRIGger:EXECute .....	6.465
[SOURce<[1]2>:]BB:WLAN:PLCP:LCBit:STATe .....	6.458	[SOURce<[1]2>:]BB:WLAN:TRIGger:OBASband: INHibit .....	6.466
[SOURce<[1]2>:]BB:WLAN:PRESet .....	6.458	[SOURce<[1]2>:]BB:WLAN:TRIGger:OBASband: DELay .....	6.466
[SOURce<[1]2>:]BB:WLAN:PSDU:BRATe .....	6.475	[SOURce<[1]2>:]BB:WLAN:TRIGger: OUTPut<[1]...4>:DELay .....	6.467
[SOURce<[1]2>:]BB:WLAN:PSDU:BSPReading: STATe .....	6.475	[SOURce<[1]2>:]BB:WLAN:TRIGger: OUTPut<[1]...4>:DELay:FIXed .....	6.467
[SOURce<[1]2>:]BB:WLAN:PSDU:DATA .....	6.476	[SOURce<[1]2>:]BB:WLAN:TRIGger: OUTPut<[1]...4>:DELay:MAXimum? .....	6.467
[SOURce<[1]2>:]BB:WLAN:PSDU:DATA:DSElect .....	6.476	[SOURce<[1]2>:]BB:WLAN:TRIGger: OUTPut<[1]...4>:DELay:MINimum? .....	6.468
[SOURce<[1]2>:]BB:WLAN:PSDU:DATA:PATtern .....	6.477	[SOURce<[1]2>:]BB:WLAN:TRIGger: OUTPut<[1]...4>:MODE .....	6.468
[SOURce<[1]2>:]BB:WLAN:PSDU:DLENgth .....	6.477	[SOURce<[1]2>:]BB:WLAN:TRIGger: OUTPut<[1]...4>:OFFTime .....	6.469
[SOURce<[1]2>:]BB:WLAN:PSDU:MAC: ADDRess<[1]2 3 4>:STATe .....	6.478	[SOURce<[1]2>:]BB:WLAN:TRIGger: OUTPut<[1]...4>:ONTime .....	6.469
[SOURce<[1]2>:]BB:WLAN:PSDU:MAC:DiD .....	6.478	[SOURce<[1]2>:]BB:WLAN:TRIGger: OUTPut<[1]...4>:PULSe:DIVider .....	6.470
[SOURce<[1]2>:]BB:WLAN:PSDU:MAC:FCONtrol .....	6.478	[SOURce<[1]2>:]BB:WLAN:TRIGger: OUTPut<[1]...4>:PULSe:FREQuency? .....	6.470
[SOURce<[1]2>:]BB:WLAN:PSDU:MAC:FCONtrol: FDS .....	6.479	[SOURce<[1]2>:]BB:WLAN:TRIGger: OUTPut<[1]...4>:PATtern .....	6.469
[SOURce<[1]2>:]BB:WLAN:PSDU:MAC:FCONtrol: MDATa .....	6.479	[SOURce<[1]2>:]BB:WLAN:TRIGger:RMODE? .....	6.471
[SOURce<[1]2>:]BB:WLAN:PSDU:MAC:FCONtrol: MFRagments .....	6.479	[SOURce<[1]2>:]BB:WLAN:TRIGger:SLENgth .....	6.471
[SOURce<[1]2>:]BB:WLAN:PSDU:MAC:FCONtrol: ORDer .....	6.479	[SOURce<[1]2>:]BB:WLAN:TRIGger:SLUNit .....	6.472
[SOURce<[1]2>:]BB:WLAN:PSDU:MAC:FCONtrol: PMAngement .....	6.479	[SOURce<[1]2>:]BB:WLAN:TRIGger:SOURce .....	6.472
[SOURce<[1]2>:]BB:WLAN:PSDU:MAC:FCONtrol: PVERsion .....	6.479	[SOURce<[1]2>:]BB:WLAN:TTIME .....	6.473
[SOURce<[1]2>:]BB:WLAN:PSDU:MAC:FCONtrol: RETRY .....	6.479	[SOURce<[1]2>:]BB:WLAN:WAVeform:CREate .....	6.483
[SOURce<[1]2>:]BB:WLAN:PSDU:MAC:FCONtrol: SUBType .....	6.479	[SOURce<[1]2>:]CORRection:CSET[:SELect] .....	6.677
[SOURce<[1]2>:]BB:WLAN:PSDU:MAC:FCONtrol: TDS .....	6.479	[SOURce<[1]2>:]CORRection:CSET: DATA[:SENSor<[1]2 3>[:POWer]:SONCe .....	6.672
[SOURce<[1]2>:]BB:WLAN:PSDU:MAC:FCONtrol: TYPE .....	6.479	[SOURce<[1]2>:]CORRection:DEXChange:AFILe: CATalog? .....	6.673
[SOURce<[1]2>:]BB:WLAN:PSDU:MAC:FCONtrol: WEP .....	6.479	[SOURce<[1]2>:]CORRection:DEXChange:AFILe: EXTension .....	6.673



[SOURce<[1]2>:]CORRection:DEXChange:AFILe: SElect .....	6.674	[SOURce<[1]2>:]PULM:POLarity .....	6.732
[SOURce<[1]2>:]CORRection:DEXChange:AFILe: SEParator:COLumn .....	6.674	[SOURce<[1]2>:]PULM:SOURce .....	6.733
[SOURce<[1]2>:]CORRection:DEXChange:AFILe: SEParator:DEcimal.....	6.675	[SOURce<[1]2>:]PULM:STATe .....	6.733
[SOURce<[1]2>:]CORRection:DEXChange: EXECute .....	6.675	[SOURce<[1]2>:]SWEep[:FREQuency]:DWELl.....	6.737
[SOURce<[1]2>:]CORRection:DEXChange:MODE	6.676	[SOURce<[1]2>:]SWEep[:FREQuency]:EXECute ...	6.737
[SOURce<[1]2>:]CORRection:DEXChange:SElect	6.676	[SOURce<[1]2>:]SWEep[:FREQuency]:MODE .....	6.738
[SOURce<[1]2>:]FM[:DEViation] .....	6.678	[SOURce<[1]2>:]SWEep[:FREQuency]:POINts .....	6.738
[SOURce<[1]2>:]FREQuency[:CW]:FIXed] .....	6.682	[SOURce<[1]2>:]SWEep[:FREQuency]:SPACing ...	6.739
[SOURce<[1]2>:]FREQuency:CENTer .....	6.682	[SOURce<[1]2>:]SWEep[:FREQuency]: STEP[:LINear] .....	6.739
[SOURce<[1]2>:]FREQuency:MANual .....	6.683	[SOURce<[1]2>:]SWEep[:FREQuency]: STEP:LOGarithmic .....	6.740
[SOURce<[1]2>:]FREQuency:MODE .....	6.684	[SOURce<[1]2>:]SWEep:POWer:AMODE .....	6.740
[SOURce<[1]2>:]FREQuency:OFFSet .....	6.684	[SOURce<[1]2>:]SWEep:POWer:DWELl .....	6.741
[SOURce<[1]2>:]FREQuency:SPAN .....	6.685	[SOURce<[1]2>:]SWEep:POWer:EXECute .....	6.741
[SOURce<[1]2>:]FREQuency:START .....	6.685	[SOURce<[1]2>:]SWEep:POWer:MODE .....	6.741
[SOURce<[1]2>:]FREQuency:STEP[:NCRement] ..	6.686	[SOURce<[1]2>:]SWEep:POWer:POINts .....	6.742
[SOURce<[1]2>:]FREQuency:STEP:MODE .....	6.687	[SOURce<[1]2>:]SWEep:POWer:SPACing:MODE?6.742	
[SOURce<[1]2>:]FREQuency:STOP .....	6.686	[SOURce<[1]2>:]SWEep:POWer: STEP[:LOGarithmic] .....	6.742
[SOURce<[1]2>:]IQ:CREStfactor .....	6.691	[SOURce<[1]2>:]POWer:ALC:OMODE .....	6.725
[SOURce<[1]2>:]IQ:GAIN .....	6.692	[SOURce:]AM:BBANd[:STATe] .....	6.41
[SOURce<[1]2>:]IQ:IMPairment[:STATe] .....	6.693	[SOURce:]AM:BBANd:SENSitivity? .....	6.41
[SOURce<[1]2>:]IQ:IMPairment:LEAKage:I .....	6.692	[SOURce:]BB:GPS:TRIGger:SLUNit .....	6.238
[SOURce<[1]2>:]IQ:IMPairment:LEAKage:Q .....	6.693	[SOURce:]BB:IQOutput:SOURce .....	6.293
[SOURce<[1]2>:]IQ:SOURce .....	6.693	[SOURce:]BB:PATH:COUNT .....	6.54
[SOURce<[1]2>:]IQ:STATe .....	6.694	[SOURce:]BB:W3GPp:GPP3:VERsion? .....	6.493
[SOURce<[1]2>:]IQ:SWAp[:STATe] .....	6.694	[SOURce:]BB:W3GPp:TS25141:AWGN:CNRatio .....	6.641
[SOURce<[1]2>:]IQ:WBState .....	6.694	[SOURce:]BB:W3GPp:TS25141:AWGN:ENRatio .....	6.642
[SOURce<[1]2>:]LIS:DWELl .....	6.711	[SOURce:]BB:W3GPp:TS25141:AWGN:POWer: NOISe .....	6.642
[SOURce<[1]2>:]LIST:CATalog? .....	6.706	[SOURce:]BB:W3GPp:TS25141:AWGN:RBLock: RATE .....	6.643
[SOURce<[1]2>:]LIST:DElete .....	6.706	[SOURce:]BB:W3GPp:TS25141:AWGN: RPDetection:RATE .....	6.643
[SOURce<[1]2>:]LIST:DElete:ALL .....	6.707	[SOURce:]BB:W3GPp:TS25141:AWGN:STATe .....	6.644
[SOURce<[1]2>:]LIST:DEXChange:AFILe: CATalog? .....	6.707	[SOURce:]BB:W3GPp:TS25141:BSPClass .....	6.644
[SOURce<[1]2>:]LIST:DEXChange:AFILe: SEParator:COLumn .....	6.709	[SOURce:]BB:W3GPp:TS25141:BSSignal: FREQuency .....	6.644
[SOURce<[1]2>:]LIST:DEXChange:AFILe: SEParator:DEcimal.....	6.709	[SOURce:]BB:W3GPp:TS25141:BSSignal:POWer ..	6.645
[SOURce<[1]2>:]LIST:DEXChange:EXECute .....	6.710	[SOURce:]BB:W3GPp:TS25141:EMODE .....	6.645
[SOURce<[1]2>:]LIST:DEXChange:MODE .....	6.710	[SOURce:]BB:W3GPp:TS25141:IFSignal:BWIDth ...	6.646
[SOURce<[1]2>:]LIST:DEXChange:SElect .....	6.711	[SOURce:]BB:W3GPp:TS25141:IFSignal:CNRatio ..	6.646
[SOURce<[1]2>:]LIST:FREQuency .....	6.711	[SOURce:]BB:W3GPp:TS25141:IFSignal:CW: FOFFset .....	6.647
[SOURce<[1]2>:]LIST:FREQuency:POINts? .....	6.712	[SOURce:]BB:W3GPp:TS25141:IFSignal:CW: POWer .....	6.647
[SOURce<[1]2>:]LIST:INDEX:START .....	6.712	[SOURce:]BB:W3GPp:TS25141:IFSignal:CW: STATe .....	6.648
[SOURce<[1]2>:]LIST:INDEX:STOP .....	6.713	[SOURce:]BB:W3GPp:TS25141:IFSignal:FOFFset ..	6.648
[SOURce<[1]2>:]LIST:LEARN .....	6.713	[SOURce:]BB:W3GPp:TS25141:IFSignal: MODulated:FOFFset.....	6.649
[SOURce<[1]2>:]LIST:POWer .....	6.714	[SOURce:]BB:W3GPp:TS25141:IFSignal: MODulated:POWer.....	6.649
[SOURce<[1]2>:]LIST:POWer:AMODE .....	6.715	[SOURce:]BB:W3GPp:TS25141:IFSignal: MODulated:STATe .....	6.650
[SOURce<[1]2>:]LIST:POWer:POINts? .....	6.715	[SOURce:]BB:W3GPp:TS25141:IFSignal: MODulated:TYPE .....	6.650
[SOURce<[1]2>:]LIST:TRIGger:SOURce .....	6.717	[SOURce:]BB:W3GPp:TS25141:IFSignal:POWer....	6.651
[SOURce<[1]2>:]PHASe .....	6.720	[SOURce:]BB:W3GPp:TS25141:IFSignal:SETTING: TMODEl:BSTation.....	6.651
[SOURce<[1]2>:]PHASe:REFerence .....	6.720	[SOURce:]BB:W3GPp:TS25141:IFSignal:STATe ....	6.652
[SOURce<[1]2>:]PM:SENSitivity .....	6.722	[SOURce:]BB:W3GPp:TS25141:IFSignal:TYPE .....	6.652
[SOURce<[1]2>:]POWer[:LEVel][:IMMEdiate] [:AMPLitude] .....	6.726	[SOURce:]BB:W3GPp:TS25141:SCODE .....	6.653
[SOURce<[1]2>:]POWer[:LEVel][:IMMEdiate]: OFFSet .....	6.726	[SOURce:]BB:W3GPp:TS25141:SCODE:MODE.....	6.654
[SOURce<[1]2>:]POWer:ALC[:STATe] .....	6.725	[SOURce:]BB:W3GPp:TS25141:TCASe .....	6.654
[SOURce<[1]2>:]POWer:ALC:SONCe .....	6.725	[SOURce:]BB:W3GPp:TS25141:TCASe:EXECute ...	6.655
[SOURce<[1]2>:]POWer:LIMit[:AMPLitude] .....	6.727	[SOURce:]BB:W3GPp:TS25141:TRIGger .....	6.655
[SOURce<[1]2>:]POWer:MANual .....	6.728	[SOURce:]BB:W3GPp:TS25141:WSIGnal:BTYPe ...	6.656
[SOURce<[1]2>:]POWer:MODE .....	6.729	[SOURce:]BB:W3GPp:TS25141:WSIGnal:DCRatio ..	6.657
[SOURce<[1]2>:]POWer:PEP? .....	6.729	[SOURce:]BB:W3GPp:TS25141:WSIGnal:DPCCh: SFORmat .....	6.657
[SOURce<[1]2>:]POWer:START .....	6.730		
[SOURce<[1]2>:]POWer:STEP[:INCRement] .....	6.730		
[SOURce<[1]2>:]POWer:STEP:MODE .....	6.730		
[SOURce<[1]2>:]POWer:STOP .....	6.731		
[SOURce<[1]2>:]PRESet .....	6.8		

[SOURce:]BB:W3GPP:TS25141:WSIGnal:DPCCh: TPC:RDATa .....	6.658	[SOURce:]LFOutput:SWEep[:FREQUency]:MODE ..	6.701
[SOURce:]BB:W3GPP:TS25141:WSIGnal:DPCCh: TPC:RDATa:DSElect .....	6.659	[SOURce:]LFOutput:SWEep[:FREQUency]:POINTS ..	6.702
[SOURce:]BB:W3GPP:TS25141:WSIGnal:DPCCh: TPC:RDATa:PATtern .....	6.659	[SOURce:]LFOutput:SWEep[:FREQUency]: SPACing .....	6.702
[SOURce:]BB:W3GPP:TS25141:WSIGnal:DPCCh: TPC:SDATa .....	6.660	[SOURce:]LFOutput:SWEep[:FREQUency]: STEP[:LINear] .....	6.703
[SOURce:]BB:W3GPP:TS25141:WSIGnal:DPCCh: TPC:SDATa:DSElect .....	6.661	[SOURce:]LFOutput:SWEep[:FREQUency]: STEP:LOGarithmic .....	6.703
[SOURce:]BB:W3GPP:TS25141:WSIGnal:DPCCh: TPC:SDATa:PDSTep .....	6.661	[SOURce:]LFOutput:VOLTag .....	6.704
[SOURce:]BB:W3GPP:TS25141:WSIGnal:DPCCh: TPC:SDATa:PUSSTep .....	6.662	[SOURce:]MODulation:STATe .....	6.718
[SOURce:]BB:W3GPP:TS25141:WSIGnal:DPDCh: CCODing:TYPE .....	6.662	[SOURce:]PATH:COUNT .....	6.719
[SOURce:]BB:W3GPP:TS25141:WSIGnal:DPDCh: DERRor:BIT:RATE .....	6.663	[SOURce:]POWER[:LEVel][:IMMediate]:RCL .....	6.727
[SOURce:]BB:W3GPP:TS25141:WSIGnal:DPDCh: DERRor:BLOCK:RATE .....	6.663	[SOURce:]ROSCillator[:INTernal]:ADJust[:STATe] ..	6.735
[SOURce:]BB:W3GPP:TS25141:WSIGnal: FREQUency .....	6.664	[SOURce:]ROSCillator[:INTernal]:ADJust:VALue ..	6.735
[SOURce:]BB:W3GPP:TS25141:WSIGnal:OBAND ..	6.665	[SOURce:]ROSCillator:EXTernal:FREQUency .....	6.734
[SOURce:]BB:W3GPP:TS25141:WSIGnal:PCPCh: CCODing:TYPE .....	6.666	[SOURce:]ROSCillator:EXTernal:SBANdwidth .....	6.734
[SOURce:]BB:W3GPP:TS25141:WSIGnal:POWER ..	6.666	[SOURce:]ROSCillator:SOURce .....	6.735
[SOURce:]BB:W3GPP:TS25141:WSIGnal:PRACH: CCODing:TYPE .....	6.667	[SOURce:]W3GPP:TS25141:ROUTE .....	6.653
[SOURce:]BB:W3GPP:TS25141:WSIGnal:STATe ..	6.667	[SOURce:]W3GPP:TS25141:RXDiversity .....	6.653
[SOURce:]BB:W3GPP:TS25141:WSIGnal: TRIGger[:EXTernal<[1]2>]:DELay .....	6.668	STATus:OPERation:CONDition? .....	6.743
[SOURce:]BB:W3GPP:TS25141:TRIGger:OUTPut ..	6.656	STATus:OPERation:ENABle .....	6.744
[SOURce:]BB:WIMax:VERsion? .....	6.401	STATus:OPERation:EVENT? .....	6.744
[SOURce:]BB:WLAN:FFORmat:BURSt:DELay .....	6.454	STATus:OPERation:NTRansition .....	6.744
[SOURce:]BB:WLAN:ILEaver:STATe .....	6.456	STATus:OPERation:PTRansition .....	6.744
[SOURce:]BB:WLAN:ITIMe .....	6.456	STATus:PRESet .....	6.745
[SOURce:]CORRection[:STATe] .....	6.677	STATus:QUESTionable:CONDition? .....	6.745
[SOURce:]CORRection:CSET:CATalog? .....	6.670	STATus:QUESTionable:ENABle .....	6.746
[SOURce:]CORRection:CSET:DATA:FREQUency ..	6.670	STATus:QUESTionable:EVENT? .....	6.745
[SOURce:]CORRection:CSET:DATA:FREQUency: POINTS? .....	6.671	STATus:QUESTionable:NTRansition .....	6.746
[SOURce:]CORRection:CSET:DATA:POWER .....	6.671	STATus:QUESTionable:PTRansition .....	6.745
[SOURce:]CORRection:CSET:DATA:POWER: POINTS? .....	6.671	STATus:QUEue:NEXT]? .....	6.746
[SOURce:]CORRection:CSET:DELeTe .....	6.672	SYSTem:BEEPer:STATe .....	6.747
[SOURce:]CORRection:VALue? .....	6.677	SYSTem:COMMunicate:GPIB[:SELf]:ADDRes ..	6.748
[SOURce:]FREQUency[:CW]:FIXed]:RCL .....	6.683	SYSTem:COMMunicate:GPIB:LTERminator .....	6.748
[SOURce:]INPut:DATA:IMPedance .....	6.688	SYSTem:COMMunicate:NET:RESourCe? .....	6.748
[SOURce:]INPut:DATA:THReshold .....	6.688	SYSTem:DATE .....	6.749
[SOURce:]INPut:MODext:IMPedance .....	6.689	SYSTem:DISPlay:UPDate .....	6.749
[SOURce:]INPut:TRIGger:BBANd:SLOPe .....	6.689	SYSTem:ERRor[:NEXT]? .....	6.750
[SOURce:]INPut:TRIGger:IMPedance .....	6.689	SYSTem:ERRor:ALL? .....	6.749
[SOURce:]INPut:TRIGger:LEVel .....	6.690	SYSTem:ERRor:CODE[:NEXT]? .....	6.750
[SOURce:]INPut:TRIGger:SLOPe .....	6.690	SYSTem:ERRor:CODE:ALL? .....	6.749
[SOURce:]IQ:OUTPut:BIAS:COUPling[:STATe] .....	6.695	SYSTem:ERRor:CODE:COUNT? .....	6.750
[SOURce:]IQ:OUTPut:BIAS:I .....	6.696	SYSTem:KLOCK .....	6.751
[SOURce:]IQ:OUTPut:BIAS:OPTimization[:RF]: STATe .....	6.696	SYSTem:PRESet .....	6.751
[SOURce:]IQ:OUTPut:BIAS:Q .....	6.696	SYSTem:PROTect<n>[:STATe] .....	6.751
[SOURce:]IQ:OUTPut:LEVel .....	6.696	SYSTem:SERRor? .....	6.752
[SOURce:]IQ:OUTPut:MODE .....	6.697	SYSTem:TIME .....	6.752
[SOURce:]IQ:OUTPut:OFFSet:I .....	6.697	SYSTem:VERsion? .....	6.752
[SOURce:]IQ:OUTPut:OFFSet:Q .....	6.697	TEST<[1]2>:DIRect .....	6.754
[SOURce:]IQ:OUTPut:TYPE .....	6.697	TEST:CONNector:AUXio? .....	6.753
[SOURce:]LFOutput[:STATe] .....	6.700	TEST:CONNector:BNC? .....	6.753
[SOURce:]LFOutput:FREQUency .....	6.699	TRIGger<[1]2>[:PSWeep][:IMMediate] .....	6.757
[SOURce:]LFOutput:FREQUency:MANual .....	6.699	TRIGger<[1]2>[:SWEep][:IMMediate] .....	6.758
[SOURce:]LFOutput:FREQUency:MODE .....	6.699	TRIGger<[1]2>:FSWeep[:IMMediate] .....	6.755
[SOURce:]LFOutput:FREQUency:STARt .....	6.700	TRIGger<[1]2>:FSWeep:SOURce .....	6.756
[SOURce:]LFOutput:FREQUency:STOP .....	6.700	TRIGger<[1]2>:LIST[:IMMediate] .....	6.756
[SOURce:]LFOutput:SWEep[:FREQUency]:DWELI ..	6.701	TRIGger<[1]2>:PSWeep:SOURce .....	6.757
[SOURce:]LFOutput:SWEep[:FREQUency]: EXECute .....	6.701	TRIGger<[1]2>:SWEep:SOURce .....	6.758
		TRIGger0[:SWEep]:SOURce .....	6.755
		UNIT:ANGLE .....	6.759
		UNIT:POWER .....	6.759
		COMMENT tag .....	6.101
		Common commands .....	6.4
		Common Control - MS - CDMA2000 .....	6.181, 4.604
		Compressed Mode - BS - 3GPP FDD .....	6.542, 4.356
		Compressed Mode - UE - 3GPP FDD .....	6.581, 4.418
		Configuration Change Count - WiMAX .....	6.440, 4.675
		Configure active Subchannels - WiMAX .....	6.426, 4.689
		Configure Control Signal - DM .....	4.192
		Configure Control Signal - GSM/EDGE .....	4.305
		Configure MAC - WiMAX .....	4.678, 4.697, 4.699, 4.700
		Conflict bursts OFDMA - WiMAX .....	6.411
		Connection to external controller .....	1.28

Constant slot length - GSM/EDGE..... 6.272, 4.278  
 Constellation diagram..... 4.38  
 Constellation Version Parameter - b - TD-SCDMA.....  
 ..... 6.352, 4.778  
 Constellation Version Parameter b - BS - 3GPP FDD.....  
 ..... 6.528, 4.375  
 Control Lists - DM..... 6.210, 4.186  
 Control Power PCPCH - UE - 3GPP FDD..... 6.604, 4.438  
 Control Power PRACH - UE - 3GPP FDD..... 6.613, 4.428  
 Control signals..... 4.159  
 Controller, external..... 1.28  
 Convolution Coder - BS - CDMA2000..... 6.148, 4.594  
 Convolution Coder - BS1 - 3GPP FDD..... 6.562, 4.389  
 Convolution Coder - UE1 - 3GPP FDD..... 6.634, 4.476  
 Copy - Data Editor..... 4.189  
 Copy Base Station - CDMA2000..... 6.116, 4.553  
 Copy Base Station -3GPP FDD..... 6.489, 4.330  
 Copy Cell - TD-SCDMA..... 6.322, 4.754  
 Copy Cell Settings - TD-SCDMA..... 4.754  
 Copy from Source - 3GPP FDD..... 6.490, 4.330  
 Copy from Source - CDMA2000..... 6.117, 4.553  
 Copy From Source - TD-SCDMA..... 4.754  
 Copy instrument settings..... 6.24, 4.29  
 Copy Mobile Station - CDMA2000..... 6.116, 4.553  
 Copy To Destination - TD-SCDMA..... 6.321, 4.754  
 Copy User Equipment -3GPP FDD..... 6.489, 4.330  
 Copying base/user equipment data - 3GPP FDD..... 4.330  
 Copying the data of a base or user equipment -  
 3GPP FDD..... 6.489  
 Counter..... 6.17, 4.8  
 Couple I/Q Bias..... 4.126  
 Coupling mode - EXT MOD (AM)..... 6.42, 4.99  
 Coupling mode - EXT MOD (FM)..... 6.679, 4.107  
 Coupling mode - EXT MOD (PhiM)..... 4.111  
 Coupling mode - EXT MOD (PM)..... 6.721  
 CQI Length HS-DPCCH - UE - 3GPP FDD..... 6.584, 4.453  
 CQI Values HS-DPCCH - UE - 3GPP FDD..... 6.585, 4.453  
 CRC - TD-SCDMA..... 6.348, 6.356, 4.780  
 CRC Length - BS - CDMA2000..... 6.146, 4.593  
 Create - ARB..... 4.232  
 Create - ARB MCAR..... 4.243  
 Create and Load - ARB..... 4.232, 4.244  
 Create Multi-Carrier Waveforms - ARB..... 4.234  
 Create Multisegment Waveforms - ARB..... 4.228  
 Create New Directory..... 4.29  
 Crest factor - baseband..... 6.315, 4.134  
 Crest factor - Clipping - 3GPP FDD..... 6.486, 4.333  
 Crest factor - Clipping - CDMA2000..... 6.112, 4.556  
 Crest factor - Clipping - TD-SCDMA..... 4.757  
 Crest Factor - MCCW..... 6.299, 4.248  
 Crest Factor - TD-SCDMA..... 6.340, 4.769  
 Crest factor - timing offset - BS - 3GPP FDD..... 6.538, 4.371  
 Crest factor (I/Q)..... 6.691, 4.121  
 Crest Factor Mode - ARB MCAR..... 6.64, 4.237  
 Crest Factor, desired range - CDMA2000..... 6.137, 4.570  
 Crestfaktor - 3GPP FDD..... 4.350  
 Cross-over RJ-45 cable..... 1.21  
 CTRL+I key combination..... 3.10  
 Current Dynamic Range - CDMA2000..... 6.129, 4.566  
 Current Dynamic Range - TD-SCDMA..... 4.767  
 Current Freq (LF Sweep)..... 6.699, 4.93  
 Current Freq (RF Sweep)..... 6.683, 4.83  
 Current Level..... 6.728, 4.89  
 Current Range without Recalculation - 3GPP FDD.....  
 ..... 6.501, 4.344  
 Current Range without Recalculation - ARB..... 6.80, 4.225  
 Current Range without Recalculation - DM..... 6.204, 4.203  
 Current Range without Recalculation - GPS..... 6.233, 4.739  
 Current Range without Recalculation - GSM/EDGE.....  
 ..... 6.283, 4.289  
 Current Range without Recalculation - MCCW..... 6.310, 4.258  
 Current Range without Recalculation - WiMAX..... 6.395, 4.715  
 Current Range without Recalculation - WLAN..... 6.467, 4.648

Current Range Without Recalculation Maximum -  
 TD-SCDMA..... 6.333  
 Current Range Without Recalculation Minimum -  
 TD-SCDMA..... 6.334  
 Current Segment - ARB..... 4.212  
 Cursor Length - DM..... 4.193  
 Cursor Position - DM..... 4.194  
 Cursor Position - GSM/EDGE..... 4.307  
 Custom Digital Modulation..... 6.186, 4.162  
 Cut..... 4.29  
 Cut - Data Editor..... 4.189  
 Cut Off Frequency Shift - WiMAX..... 4.707  
 CW (continuous wave)..... 4.159  
 CW Frequency Offset - Test Case Wizard - 3GPP.....  
 ..... 6.647, 4.518  
 CW Interferer..... 4.136  
 CW Interferer Level - Test Case Wizard - 3GPP.....  
 ..... 6.647, 4.518  
 CW Interferer State - Test Case Wizard - 3GPP.....  
 ..... 6.648, 4.518  
 CW MODE - Input..... 1.9, 4.18  
 CW Switching - DM..... 6.201, 4.182

## D

Data - BS - 3GPP FDD..... 6.517, 4.370  
 Data - BS - CDMA2000..... 6.149, 4.585  
 Data - MS - CDMA2000..... 6.176, 4.610  
 Data (DPDCH) - Multichannel BS - 3GPP FDD..... 4.411  
 Data Bits Per Frame - TD-SCDMA..... 6.348, 6.355, 4.778  
 Data Config - BS - 3GPP FDD..... 4.370  
 Data format - block data..... 6.19  
 Data format - query command..... 6.19  
 Data GSM unframed..... 6.265, 4.270  
 DATA input/output..... 1.9, 1.11, 4.18  
 Data Length - WiMAX..... 6.412, 6.433, 4.670, 4.691  
 Data Length - WLAN..... 6.477  
 Data List - TD-SCDMA..... 6.350, 6.357, 4.786  
 Data List Management - GSM/EDGE..... 4.268  
 Data List Management - TD-SCDMA..... 4.750  
 Data List Management - WiMAX..... 4.657, 4.689  
 Data List..... 4.152  
 Data Lists - DM..... 6.213, 4.186  
 Data Modulation - TD-SCDMA..... 4.743  
 Data out of range (-222)..... 9.5  
 Data pattern - CDMA2000..... 4.586, 4.611  
 Data pattern - DM..... 6.194, 4.176  
 Data pattern - GSM/EDGE..... 4.270  
 Data Pattern - TD-SCDMA..... 6.350, 6.357  
 Data pattern - WLAN..... 4.633  
 Data Power PCPCH - UE - 3GPP FDD..... 6.605, 4.437  
 Data Power PRACH - UE - 3GPP FDD..... 6.614, 4.428  
 Data Rate - BS - CDMA2000..... 6.151, 4.584  
 Data Rate - MS - CDMA2000..... 6.177, 4.609  
 Data Rate - Predefined Settings - CDMA2000..... 6.139, 4.570  
 Data rate matching - BS1 - 3GPP FDD..... 6.563, 4.389  
 Data rate matching - UE1 - 3GPP FDD..... 6.635, 4.476  
 Data source..... 4.316  
 Data Source - DM..... 6.199, 4.176  
 Data Source - TD-SCDMA..... 6.349, 6.356, 4.779, 4.786  
 Data Source - Transport Channel - BS1 - 3GPP FDD.....  
 ..... 6.560, 4.388  
 Data Source - Transport Channel - UE1 - 3GPP FDD.....  
 ..... 6.633, 4.475  
 Data Source DCCH - UE1 - 3GPP FDD..... 6.577, 4.460  
 Data Source DPDCH - UE - 3GPP FDD..... 6.576, 4.459  
 Data Source E-DPDCH - UE - 3GPP FDD..... 6.599, 4.465  
 Data Source F-DPCH - BS - 3GPP FDD..... 4.403  
 Data source for data fields of slot - GSM/EDGE..... 6.265, 4.298  
 Data Source PCPCH - UE - 3GPP FDD..... 6.604, 4.439  
 Data Source Power Control - BS - CDMA2000..... 6.156, 4.589  
 Data Source Power Control - MS - CDMA2000..... 6.183, 4.606

Data Source PRACH - UE - 3GPP FDD	6.613, 4.429
Data type error (-104)	9.5
Data/Control List Management - DM	4.177
Date - GPS	6.246, 4.728
DCCH On - TD-SCDMA	6.351, 6.358, 4.779
DCCH On Enhanced DPCH - BS1 - 3GPP FDD	6.564, 4.387
DCD Count - WiMAX	6.421
DCH Slot - TD-SCDMA	6.355, 4.776
DCH Spreading Code Selection - TD-SCDMA	6.354, 4.776
DCH State - TD-SCDMA	6.355, 4.774
DCL	5.19
Deactivate Cell	4.755
Deactivate Cell - TD-SCDMA	4.770
Deactivate Slot - TD-SCDMA	6.343, 4.772
Deactivate TD-SCDMA Standard	4.748
Decimal point	5.16
Decimal Point Import/Export - List Mode data	6.709, 4.78
Decimal Point Import/Export - User Correction data	6.675, 4.66
Dedicated Slot Mode - TD-SCDMA	6.372, 4.782
Default instrument settings	6.751, 1.16, 4.4
Default settings - 3GPP FDD	6.544, 4.321, 4.329
Default settings - ARB	6.73, 4.210
Default settings - ARB MCAR	6.69, 4.235
Default settings - CDMA2000	6.123, 6.169, 4.545, 4.552
Default settings - DM	6.197, 4.173
Default settings - GSM/EDGE	6.275, 4.262
Default settings - MCCW	6.305, 4.246
Default settings - TD-SCDMA	6.327, 6.328, 4.753
Default Settings - TD-SCDMA	4.748, 4.754, 4.768
Default settings - WiMAX	6.388, 4.655
Default settings - WLAN	6.458
Default settings RF - GPS	6.227, 4.721
Default values MS - CDMA2000	6.181, 4.552
Default Values User Equipment - 3GPP FDD	4.329
Delay - Falling Edge of Ramp Envelope - DM	6.195, 4.197
Delay - Marker - 3GPP FDD	6.501, 4.344
Delay - Marker - ARB	6.78, 4.225
Delay - Marker - CDMA2000	6.129, 4.566
Delay - Marker - DM	6.203, 4.203
Delay - Marker - GPS	6.232, 4.739
Delay - Marker - GSM/EDGE	4.289
Delay - Marker - MCCW	6.309, 4.258
Delay - Marker - TD-SCDMA	6.333, 4.766
Delay - Marker - WiMAX	6.394, 4.715
Delay - Marker - WLAN	6.467, 4.648
Delay - Rising Edge of Ramp Envelope - DM	6.195, 4.196
Delay - Trigger - 3GPP FDD	6.499
Delay - Trigger - ARB	6.76, 4.223
Delay - Trigger - CDMA2000	6.127, 4.563
Delay - Trigger - DM	6.202, 4.201
Delay - Trigger - GPS	6.231, 4.736
Delay - Trigger - MCCW	6.308, 4.256
Delay - Trigger - TD-SCDMA	6.331, 4.764
Delay - Trigger - WiMAX	6.393, 4.712
Delay - Trigger - WLAN	6.465, 4.646
Delay Start - ARB MCAR	6.60, 6.65, 4.240
Delay Step - ARB MCAR	6.66, 4.241
Delete - ARB	4.231
Delete 3GPP FDD settings	4.322
Delete CDMA2000 settings	4.547
Delete GSM settings	4.266
Delete instrument settings	6.26, 4.29
Delimiter	5.19
Delta Phase	6.720, 4.46
Desired Crest Factor - MCCW	6.298, 4.249
Destination Import/Export - List Mode data	6.711, 4.78
Destination Import/Export - User Correction data	6.676, 4.67
Deviation - FSK Modulation - DM	6.193, 4.180
Deviation - FSK Modulation - GSM/EDGE	6.272, 4.278
Deviation - Variable FSK Modulation - DM	6.193, 4.182
Device reset	6.8
Device-specific error (-300)	9.5
DHCP	1.21
Differential coding - DM	6.190
Differential coding - DM	4.179
Differential I/Q-Outputs	6.695
Differential output	4.124
Digital I/O interface	1.10
Digital Modulation	6.186, 4.162
Direction BS1 - 3GPP FDD	6.556, 4.395
Direction UE1 - 3GPP FDD	4.479
Directory	6.24, 4.27
Disable Barker Spreading (CCK,PBCC) - WLAN	6.475, 4.635
Discontinuous Transmission - E-DPCCH - UE - 3GPP FDD	6.592, 4.449
Discontinuous Transmission - E-DPDCH - UE - 3GPP FDD	6.600
Display	3.8
Display Range OFDMA - WiMAX	4.685
Distance - BS - 3GPP FDD	6.540, 4.361
Distance - UE - 3GPP FDD	6.579, 6.580, 4.423
Distance UpPTS - TD-SCDMA	6.376, 4.792
dit Data List - TD-SCDMA	4.750
Diversity - Test Case Wizard - 3GPP	6.653, 4.487
Diversity Mode- BS - CDMA2000	6.171, 4.574
Divider - GSM/EDGE	6.255, 4.291
DL Frame Structure - BS - 3GPP FDD	6.539, 4.359
DLList/Pattern - TD-SCDMA	6.364, 4.786
DL-MAP Base Station ID - WiMAX	4.697
DL-MAP DCD Count - WiMAX	4.697
DL-UL Timing Offset DPCCH - UE - 3GPP FDD	4.444
Do Conf - BS - 3GPP FDD	4.372
Do Conf - BS - CDMA2000	6.163, 4.586
Domain Conflict - TD-SCDMA	6.364, 4.787
Doppler Shift - GPS	6.248, 4.731
Double dagger (#)	5.18
Down Range - Dyn Power Control BS1 - 3GPP FDD	6.557, 4.395
Down Range - Dyn Power Control UE1 - 3GPP FDD	6.629, 4.480
Downlink - 3GPP FDD	6.512, 4.324
Downlink - CDMA2000	6.142, 4.549
Downlink - TD-SCDMA	4.751
Downlink - WiMAX	6.386, 4.660
Downlink Subframe Duration - WiMAX	6.391, 4.661
DPCCCH + DPDCH - UE - 3GPP FDD	6.603, 4.417
DPCCCH Settings	4.397
DPCH Spreading Factor - TD-SCDMA	6.340, 4.769
Driver initialization failed (204)	9.11
DTCH On - TD-SCDMA	6.351, 6.358, 4.779
DTCH On Enhanced DPCH - BS1 - 3GPP FDD	6.564, 4.387
DTX - E-DPCCH - UE - 3GPP FDD	6.592, 4.449
DTX - E-DPDCH - UE - 3GPP FDD	6.600
DTX Indication Bits - BS1 - 3GPP FDD	6.562, 4.389
DTX Pattern - E-DPCCH UE - 3GPP FDD	4.449
DTX Pattern (bin) - E-DPDCH UE - 3GPP FDD	4.463
Dummy Burst - GSM/EDGE	6.261, 4.294
Duration Id - WLAN	6.478, 4.637
Dwell Time - Level Sweep	6.741, 4.89
Dwell Time - LF Sweep	6.701, 4.94
Dwell time - List Mode	6.711, 4.73
Dwell Time - List Mode	6.711, 4.73
Dwell Time - RF Sweep	6.737, 4.84
DwPTS Power - TD-SCDMA	6.342, 4.771
Dynamic Power Control BS1 - 3GPP FDD	6.558, 4.394
Dynamic Power Control Direction BS1 - 3GPP FDD	6.556, 4.395
Dynamic Power Control Direction UE1 - 3GPP FDD	6.628, 4.479
Dynamic Power Control Mode BS1 - 3GPP FDD	6.557, 4.394

Dynamic Power Control Mode UE1 - 3GPP FDD ..... 6.629, 4.479  
 Dynamic Power Control UE1 - 3GPP FDD ..... 6.630, 4.479

**E**

E-DCH TTI – E-DPDCH UE - 3GPP FDD ..... 4.462  
 E-DCH TTI – HSUPA FRC - 3GPP FDD ..... 6.598, 4.467  
 EDGE Burst - GSM/EDGE ..... 6.261, 4.293  
 Edge form - GSM/EDGE ..... 6.274, 4.280  
 Edge form of ramp envelope - DM ..... 6.195, 4.196  
 Edge offset - GSM/EDGE ..... 6.274, 4.280  
 Edge slope - GSM/EDGE ..... 6.274, 4.280  
 Edge slope of ramp envelope - DM ..... 6.196, 4.196  
 Edit Data List - WiMAX ..... 4.657, 4.689  
 Edit Mode - Test Case Wizard - 3GPP ..... 6.645, 4.486  
 Edit User Correction Data ..... 4.63  
 Effective Data Rate - BS - CDMA2000 ..... 6.146, 4.593  
 E-HICH Settings - 3GPP FDD ..... 4.407  
 EMF - Level display ..... 4.55  
 Enable/disable beep ..... 6.747  
 Enhanced - TD-SCDMA ..... 6.368, 4.784  
 Enhanced Access - MS - CDMA2000 ..... 6.181, 4.604  
 Enhanced Channel Settings - TD-SCDMA ..... 4.772  
 Enhanced Channels Coding - BS1 - 3GPP FDD ..... 6.551, 4.384  
 Enhanced DPCH Channels State - BS1 - 3GPP FDD ..... 6.560, 4.382  
 Enhanced P-CCPCH Channel State - BS1 - 3GPP FDD ..... 4.379  
 Enhanced Settings - BS - 3GPP FDD ..... 4.368, 4.379  
 Entry field ..... 3.14  
 Envelope - GSM/EDGE ..... 4.279  
 EOI (command line) ..... 5.15  
 E-RGCH Settings - 3GPP FDD ..... 4.407  
 ERROR LED ..... 1.2  
 Error messages ..... 9.3, 9.4, 3.9  
 Error messages - display list ..... 6.752  
 Error Protection - BS - CDMA2000 ..... 6.148, 4.594  
 Error Protection - BS1 - 3GPP FDD ..... 6.562, 4.389  
 Error Protection - TD-SCDMA ..... 6.350, 6.357, 4.781  
 Error Protection - UE1 - 3GPP FDD ..... 6.634, 4.476  
 Error queue ..... 5.27  
 Error queue query ..... 6.746, 6.749, 6.750  
 ESE (event status enable register) ..... 5.25  
 Ethernet ..... 1.20  
 Ethernet - Remote control ..... 5.5  
 ETSC - Extended Training Sequence - GSM/EDGE ..... 6.262, 4.300  
 Event status enable register (ESE) ..... 5.25  
 Example for setting ..... 2.11  
 Examples of application ..... 2.5  
 Exclude Frequency ..... 6.683, 4.27  
 Exclude Level ..... 6.727, 4.28  
 Execute Single - List Mode ..... 6.716, 4.73  
 Execute Single Sweep - Frequency Sweep ..... 6.737, 4.82  
 Execute Single Sweep - Level Sweep ..... 6.741, 4.88  
 Execute Single Sweep - LF Sweep ..... 6.701, 4.92  
 Execute Trigger - 3GPP FDD ..... 6.498, 4.340  
 Execute Trigger - ARB ..... 6.75, 4.218  
 Execute Trigger - CDMA2000 ..... 6.127, 4.563  
 Execute Trigger - DM ..... 6.201, 4.184  
 Execute Trigger - GPS ..... 6.231, 4.735  
 Execute Trigger - GSM/EDGE ..... 6.279, 4.267  
 Execute Trigger - MCCW ..... 6.307, 4.255  
 Execute Trigger - TD-SCDMA ..... 6.331, 4.752, 4.764  
 Execute Trigger - WiMAX ..... 6.392, 4.711  
 Execute Trigger - WLAN ..... 6.465, 4.645  
 Expiration date of option ..... 4.10  
 Exponent ..... 5.16  
 Exponent too large (-123) ..... 9.5  
 EXT MOD IN A/B ..... 1.7  
 EXT REF ..... 9.2  
 EXT TUNE input ..... 1.9, 4.18, 4.47  
 Extended Trigger Mode - ARB ..... 4.213, 4.214  
 Extension Import/Export - List Mode data ..... 6.708, 4.77  
 Extension Import/Export - User Correction data ..... 6.673, 6.674, 4.66  
 External Clock Trigger Delay - GSM/EDGE ..... 4.286  
 External Clock Trigger Inhibit - GSM/EDGE ..... 6.280, 4.286  
 External Input Impedance ..... 6.689, 4.104  
 External modulation data ..... 4.153  
 External modulation signal - FM ..... 4.104  
 External modulation signal - PhiM ..... 4.108  
 External modulation signal - voltage ..... 4.96, 4.97  
 External Power Control BS1 - 3GPP FDD ..... 4.394  
 External Power Control UE1 - 3GPP FDD ..... 6.630, 4.479  
 External Reference Frequency ..... 6.734, 4.48  
 External Trigger Delay - 3GPP FDD ..... 6.499  
 External Trigger Delay - ARB ..... 6.76, 4.223  
 External Trigger Delay - CDMA2000 ..... 6.127, 4.563  
 External Trigger Delay - DM ..... 6.202, 4.201  
 External Trigger Delay - GPS ..... 6.231, 4.736  
 External Trigger Delay - GSM/EDGE ..... 6.281, 4.286  
 External Trigger Delay - MCCW ..... 6.308, 4.256  
 External Trigger Delay - TD-SCDMA ..... 6.331, 4.764  
 External Trigger Delay - WiMAX ..... 6.393, 4.712  
 External Trigger Delay - WLAN ..... 6.465, 4.646  
 External Trigger Inhibit - 3GPP FDD ..... 6.499, 4.341  
 External Trigger Inhibit - ARB ..... 6.76, 4.223  
 External Trigger Inhibit - CDMA2000 ..... 6.128, 4.564  
 External Trigger Inhibit - DM ..... 6.202, 4.202  
 External Trigger Inhibit - GPS ..... 6.231, 4.736  
 External Trigger Inhibit - GSM/EDGE ..... 6.281, 4.286  
 External Trigger Inhibit - MCCW ..... 6.308, 4.256  
 External Trigger Inhibit - TD-SCDMA ..... 6.332, 4.765  
 External Trigger Inhibit - WiMAX ..... 6.393, 4.712  
 External Trigger Inhibit - WLAN ..... 6.466, 4.646  
 External tuning - Reference frequency ..... 4.47  
 Eye diagram ..... 4.39

**F**

Fall Delay - DM ..... 6.195, 4.197  
 Fall Delay - TD-SCDMA ..... 6.326, 4.761  
 Fall Offset - WiMAX ..... 4.714  
 Fall Offset - GSM/EDGE ..... 6.273, 4.280  
 Fall Offset Marker - WiMAX ..... 6.395  
 Fast switching ..... 4.54  
 FBI Mode DPCCH - UE - 3GPP FDD ..... 6.583, 4.445  
 FBI Mode PCPCH - UE - 3GPP FDD ..... 6.606, 4.438  
 FBI Pattern DPCCH - UE - 3GPP FDD ..... 6.584, 4.445  
 FBI Pattern PCPCH - UE - 3GPP FDD ..... 6.606, 4.438  
 FCS - WLAN ..... 4.639  
 FCS (checksum) ..... 6.479, 4.636  
 F-DPCH Settings ..... 4.402  
 FEC - WiMAX ..... 6.409  
 FEC State - WiMAX ..... 4.699, 4.700  
 FFT Size - WiMAX ..... 6.406, 6.444  
 FFT size- WiMAX ..... 4.684  
 FHOP\_CLK ..... 1.11  
 FHOP\_DATA ..... 1.11  
 FHOP\_STRB ..... 1.11  
 File - ARB MCAR ..... 6.62, 6.66, 4.242  
 File contains invalid data (465) ..... 9.12  
 File list ..... 6.23, 4.27  
 File Management - ARB ..... 4.211  
 File Manger ..... 4.749  
 File menu ..... 4.25  
 File size - ARB MCAR ..... 6.70  
 File type selection ..... 4.28  
 Filename missing (463) ..... 9.12  
 Fill Table - List mode ..... 4.75  
 Fill Table Range ..... 4.75

Filter - DM	6.192, 4.183
Filter - Power Sensors	4.60
Filter - TD-SCDMA	4.743, 4.752
Filter Length - Power Sensors	6.36, 4.61
Filter Parameter - 3GPP FDD	6.491, 4.333
Filter Parameter - CDMA2000	6.118, 4.556
Filter Parameter - DM	6.191, 4.183
Filter Parameter - GSM/EDGE	6.258, 4.278
Filter Parameter - TD-SCDMA	6.323, 4.757
Filter Parameter - WLAN	6.454
Filter Type - 3GPP FDD	6.493, 4.332
Filter Type - CDMA2000	6.120, 4.555
Filter Type - GSM/EDGE	6.258, 4.278
Filter Type - TD-SCDMA	6.324, 4.756
Filter Type - WLAN	6.456
Filter Type EDGE - GSM/EDGE	6.257, 4.279
Filtering, Clipping, ARB Settings - 3GPP FDD	4.325
Filtering, Clipping, ARB Settings - CDMA2000	4.550
Filtering, Clipping, ARB Settings - TD-SCDMA	4.752
Fine adjustment - Reference frequency	6.735, 4.48
Firewall	1.25
Firmware update	1.12
Firmware version	6.5, 4.10
Fix marker delay to current range - 3GPP FDD	6.501, 4.344
Fix marker delay to current range - ARB	6.78, 4.225
Fix marker delay to current range - DM	6.203, 4.204
Fix marker delay to current range - GPS	6.233, 4.739
Fix marker delay to current range - GSM/EDGE	6.282, 4.289
Fix marker delay to current range - MCCW	6.309, 4.258
Fix Marker Delay to Current Range - TD-SCDMA	4.767
Fix marker delay to current range - WiMAX	6.394, 4.715
Fix marker delay to current range - WLAN	6.467, 4.649
Fix marker to dynamic range - CDMA2000	6.129, 4.566
Fix marker to dynamic range - TD-SCDMA	6.333
Fixed field - GSM/EDGE	6.262, 4.301, 4.302
Fixed Marker Delay Maximum - 3GPP FDD	6.501
Fixed Marker Delay Maximum - GPS	6.233, 4.739
Fixed Marker Delay Maximum - WiMAX	6.395, 4.715
Fixed Marker Delay Maximum - WLAN	6.467
Fixed Marker Delay Minimum - GPS	6.233, 4.739
Fixed Marker Delay Minimum - WiMAX	6.395, 4.715
Fixed Reference Channel	6.593, 4.466
Fixed Reference Channel (FRC) – HSPA FRC - 3GPP FDD	6.593, 4.466
Floating licences	4.10
FM Deviation	6.678, 4.107
FM External Coupling	6.679, 4.107
FM External Impedance	6.689, 4.108
FM Frequency	4.108
FM Mode	6.679, 4.106
FM Sensitivity	6.680, 4.107
FM Source	6.680, 4.106
FM State	6.680, 4.106
Force Channelization Code to I/O - 3GPP FDD	6.582, 4.455
Force Channelization Code to I/O – E-DPDCH - 3GPP FDD	6.601, 4.462
Frame Body - WLAN	4.639
Frame Control - WLAN	6.478, 6.479, 4.637
Frame Length - BS - CDMA2000	6.153, 4.584
Frame Length - MS - CDMA2000	6.178, 4.609
Frame Length - Predefined Settings - CDMA2000	6.140, 4.570
Frame Number - WiMAX	6.445, 4.667
Frame Number Offset - WiMAX	6.442, 4.675, 4.697
Frame Preamble - WiMAX	6.437, 6.446, 4.667
Frame repetition - GSM/EDGE	6.260, 4.274
Frame structure	4.743
Frame structure - 3GPP FDD	4.311
Framed (double) - GSM/EDGE	6.273, 4.272
Framed (single) - GSM/EDGE	6.273, 4.270
FRC	6.593, 4.466
FREQ OFFSET	9.1
Frequency - AM	6.699, 4.100
Frequency - FM	4.108
Frequency - List mode	6.711, 4.74
Frequency - PhiM	4.112
Frequency - PM	6.699, 4.103
Frequency - Power Sensors	4.59
Frequency - RF output signal	6.682, 4.43
Frequency - RF Sweep	6.685, 4.82
Frequency - Test Signal ARB	6.86, 4.227
Frequency Correction Burst - GSM/EDGE	6.261, 4.294
Frequency display	3.8
Frequency Offset	6.684, 4.45
Frequency Offset - Baseband	6.53, 4.146
Frequency Offset - Test Case Wizard - 3GPP	6.648, 4.498, 4.509, 4.514
Front panel key emulation	3.3
FSK Deviation - DM	6.193, 4.180
FSK Deviation - GSM/EDGE	6.272, 4.278
FSK Modulation - GSM/EDGE	6.258, 4.278
FSK Type (Variable FSK) - DM	6.194, 4.181
Fuses	1.14
<b>G</b>	
Gain - ARB MCARrier	6.62
Gain (I/Q)	6.692, 4.121
Gain Start - ARB MCAR	4.240
Gain Step - ARB MCAR	4.240
Gap Distance - BS - 3GPP FDD	6.540, 4.361
Gap Distance - UE - 3GPP FDD	6.579, 6.580, 4.423
Gap Length - BS - 3GPP FDD	4.361
Gap Length - UE - 3GPP FDD	4.422
Generate Signal HD - Test Signal ARB	4.228
Generate Signal RAM - Test Signal ARB	4.228
Generate UL-MAP OFDM - WiMAX	4.668
Generate UL-MAP OFDMA - WiMAX	4.668
Generate Waveform File - 3GPP FDD	4.324
Generate Waveform File - CDMA2000	4.549
Generate Waveform File - TD-SCDMA	4.751
Generate Waveform File - WiMAX	4.658
Generate Waveform File - WLAN	4.624
Geographic Location - GPS	6.223, 4.724
GET (Group Execute Trigger)	5.20
Getting started	2.1
Global Trigger/Clock/External Inputs	4.13
GPB	4.19
GPS RF Default settings - GPS	6.227, 4.721
Greenwich Mean Time - GPS	6.246, 6.247, 6.248, 4.728
GSM/EDGE - Digital Standard	6.252, 4.260
GSM/EDGE Mode	6.273, 4.264
Guard field - GSM/EDGE	4.303
<b>H</b>	
Hadamard - CDMA2000	6.162, 4.578
Hadamard codes	4.576
Halfrate User - GSM/EDGE	4.296
Happy Bit E-DPCCH - UE - 3GPP FDD	6.592
Hardware Config	6.16, 4.8
Hardware error (-240)	9.5
Hardware missing (-241)	9.6
Hardware options	6.5, 4.9
Hardware revision out of date (201)	9.12
Header	5.12
Header suffix out of range (-114)	9.6
Hide BCH Details - TD-SCDMA	4.774
Hide Channel Details - TD-SCDMA	4.774, 4.775
Hide DCA Details - TD-SCDMA	4.775
High Power Option	4.52, 4.70, 4.86
Higher layer scheduling - BS - 3GPP FDD	4.358
Higher layer scheduling - UE - 3GPP FDD	6.579

Higher layer scheduling -BS - 3GPP FDD..... 6.539  
 HOP (hopping) ..... 1.9, 4.16  
 H-PDSCH Slot Format - BS - 3GPP FDD ..... 6.531, 4.376  
 HSDPA Mode - BS - 3GPP FDD ..... 6.529, 6.531, 4.374  
 HSDPA Settings - BS - 3GPP FDD ..... 4.373  
 H-Set - BS - 3GPP FDD ..... 6.528, 4.375

**I**

I input ..... 1.6  
 I OUT ..... 1.6  
 I OUT BAR ..... 1.6  
 I/Q diagram ..... 4.36  
 I/Q File - ARB MCAR ..... 6.62, 6.66  
 I/Q modulation ..... 6.694, 4.113, 4.115  
 I/Q modulation - baseband gain ..... 6.292, 4.121  
 I/Q modulation - Crest factor ..... 6.691, 4.121  
 I/Q modulation - gain ..... 6.692, 4.121  
 I/Q modulation - Impairments ..... 6.693, 4.116  
 I/Q Swap - I/Q ..... 6.694, 4.120  
 I/Q Wideband - I/Q ..... 6.694, 4.121  
 I/QOutput Type - I/Q out ..... 4.124  
 I/Q-Swap - CDMA2000 ..... 6.121, 4.559  
 IDCell - WiMAX ..... 6.406, 4.684  
 IEC/IEEE bus  
   command description ..... 6.1  
   Interface ..... 1.7  
 IEC/IEEE-bus address ..... 6.748, 4.19  
 Ignore 1/4 symbol - GSM/EDGE ..... 6.272, 4.278  
 Illegal parameter value (-224) ..... 9.6  
 Imbalance - I/Q analog ..... 6.692, 4.118  
 Imbalance - I/Q digital ..... 6.290, 4.131  
 Impairments analog ..... 6.693, 4.116  
 Impairments digital ..... 6.292, 4.128  
 Impedance - EXT MOD ... 6.689, 4.100, 4.104, 4.108, 4.112  
 Impedance - RF outputs ..... 6.33  
 Impedance data input (ser/par) ..... 6.688, 4.14  
 Impedance trigger/control signal input (ser/par) . 6.689, 4.14  
 Import/Export - List Mode data ..... 6.710, 4.77, 4.78  
 Import/Export - User Correction data ..... 6.675, 4.66, 4.67  
 In Baseband Only - TD-SCDMA ..... 6.326, 4.761  
 Increment every - WLAN ..... 6.480, 6.481, 4.639  
 Information Bit Payload - BS - 3GPP FDD ..... 6.527, 4.376  
 Information Bit Payload (Ninf) – HSUPA FRC - 3GPP FDD  
   ..... 6.597, 4.467  
 Initial Delay of Burst #1 - WiMAX ..... 4.661  
 Input - BURST ..... 1.9, 4.18  
 input - CLOCK ..... 1.6  
 Input - CW MODE ..... 1.9, 4.18  
 Input - DATA ..... 1.9, 1.11, 4.18  
 Input - EXT MOD ..... 1.7, 4.102  
 Input - EXT TUNE ..... 1.9, 4.18  
 Input - FHOP\_CLK ..... 1.11  
 Input - FHOP\_DATA ..... 1.11  
 Input - FHOP\_STRB ..... 1.11  
 Input - I signal ..... 1.6  
 Input - LEV-ATT ..... 1.8, 4.17  
 Input - Q signal ..... 1.6  
 Input - REF IN ..... 1.5  
 Input - TRIGGER 1 ..... 1.10  
 Input buffer ..... 5.19  
 Input Waveform File - ARB MCAR ..... 4.241  
 Insert Bit Errors - TD-SCDMA ..... 6.346, 4.777  
 Insert Errors On - Enhanced DPCHs BS1 - 3GPP FDD  
   ..... 6.555, 4.391  
 Insert Errors On - Enhanced DPDCH UE1 - 3GPP FDD  
   ..... 6.627, 4.478  
 Insert Errors On - HSDPA H-Set BS1 - 3GPP FDD ... 6.565  
 Insert Errors On - HSUPA FRC - 3GPP FDD ..... 6.594, 4.469  
 Insert Errors On - TD-SCDMA ..... 6.346, 4.777  
 Install SW-Option ..... 4.10  
 Instrument Config ..... 6.16, 4.8

Instrument settings - recall ..... 6.6, 6.26, 4.27  
 Instrument settings - save ..... 6.6, 6.28, 4.25  
 Instrument settings reset ..... 1.16  
 Instrument trigger input slope ..... 4.14  
 Inter TTI Distance - BS - 3GPP FDD ..... 4.375  
 Inter TTI Distance HS-DPCCH - UE - 3GPP FDD .....  
   ..... 6.587, 4.452  
 Interface - AUX I/O ..... 1.8, 4.17  
 Interface - Digital I/O ..... 1.10  
 Interface - IEC/IEEE bus ..... 1.7  
 Interface function IEC/IEEE bus ..... 5.29  
 Interferer Bandwidth Type - Test Case Wizard - 3GPP  
   ..... 6.646, 4.517  
 Interferer Frequency Offset - Test Case Wizard - 3GPP  
   ..... 6.648, 4.498, 4.509, 4.514  
 Interferer Level - Test Case Wizard - 3GPP ..... 6.651, 4.514  
 Interferer Level / Wanted Signal Level - Test Case Wizard -  
 3GPP ..... 6.646, 4.499  
 Interferer Modulation - Test Case Wizard - 3GPP .....  
   ..... 6.652, 4.510, 4.515, 4.518  
 Interferer Signal State - Test Case Wizard - 3GPP .....  
   ..... 6.652, 4.498, 4.509, 4.514  
 interleaver - WiMAX ..... 6.409  
 Interleaver 1 State - TD-SCDMA ..... 6.351, 6.358, 4.781  
 Interleaver 2 State - TD-SCDMA ..... 6.351, 6.358, 4.781  
 Interleaver Active OFDM - WLAN ..... 6.456, 4.635  
 Interleaver P-CCPCH - BS1 - 3GPP FDD ..... 6.567, 4.381  
 Interleaver State - WiMAX ..... 4.699, 4.700  
 Interleaver State1 - BS1 - 3GPP FDD ..... 6.563, 4.390  
 Interleaver State2 - BS1 - 3GPP FDD ..... 6.559, 4.390  
 Interleaver1 State - UE1 - 3GPP FDD ..... 6.635, 4.477  
 Interleaver2 State - UE1 - 3GPP FDD ..... 6.631, 4.477  
 Internal Baseband I/Q In ..... 6.693, 4.115  
 internalBaseld ..... 4.75  
 internalColumnId ..... 4.76  
 internalFillId ..... 4.76  
 internalIncrementId ..... 4.76  
 internalLiTaFillDialogRangeld ..... 4.75  
 internalLiTaFillDialogStartId ..... 4.75  
 InternalOptionKey ..... 4.10  
 Internet Connection Firewall ..... 1.25  
 Interrupt ..... 5.26  
 Invalid block data (-161) ..... 9.6  
 Invalid Character (-101) ..... 9.6  
 Invalid EEPROM data (203) ..... 9.12  
 Invalid filename extension (464) ..... 9.12  
 Invalid separator (-103) ..... 9.6  
 Invalid suffix (-131) ..... 9.7  
 Inverse guard ratio - WiMAX ..... 6.409, 6.448, 4.667, 4.684  
 Invert Q for Correct Baseband Output - CDMA2000 .....  
   ..... 6.121, 4.559  
 IP address ..... 1.21  
 IST flag ..... 6.5

**K**

Key - FILE ..... 4.24  
 Key - HCOPI ..... 4.21  
 Key - HELP ..... 4.22  
 Key - LOCAL ..... 4.21  
 Key - MOD ON/OFF ..... 4.96  
 Key - PRESET ..... 1.16, 4.4  
 Key - Setup ..... 4.5  
 Keyboard emulation ..... 3.3  
 Keyboard On-Screen ..... 3.3

**L**

LAN ..... 1.20, 5.5, 5.31  
 LAN - Interface ..... 5.31  
 LAN - Remote control ..... 5.5

Latitude - GPS.....	4.725
Latitude (Degrees) - GPS.....	6.224
Latitude (Direction) - GPS.....	6.224
Latitude (Minutes) - GPS.....	6.224
Latitude (Seconds) - GPS.....	6.224
Layer - Bit error insertion - BS1 - 3GPP FDD.....	4.391
Layer - Bit error insertion - UE1 - 3GPP FDD.....	4.478
LC Mask - BS - CDMA2000.....	6.154, 4.588
LC Mask - MS - CDMA2000.....	6.180, 4.605
LC Mask Step - Additional MS - CDMA2000.....	6.174, 4.571
Leakage - I/Q digital.....	6.291, 4.129
Learn List Mode Data.....	6.713, 4.73
Length of pseudo-random bit string - GSM/EDGE.....	4.270, 4.298
LEV ATT - Input/output.....	1.8, 4.17
Level - Power Sensors.....	4.58
Level - RF output.....	6.726, 4.51
Level - Step width.....	6.730, 4.53
Level - Uninterrupted setting.....	6.31, 4.52
Level - Unit.....	4.49
Level attenuation.....	4.159
Level Attenuation - DM.....	6.194, 4.197
Level Attenuation - GSM/EDGE.....	6.261, 4.281
Level control.....	6.725, 4.55
Level display.....	3.8
Level display EMF.....	4.55
Level EMF - I/Q out.....	6.696, 4.126
Level limit.....	6.727, 4.51
Level mode - ARB.....	6.94, 4.230
Level offset.....	6.726, 4.52
LEVEL OFFSET.....	9.2
Level Reference - WiMAX.....	6.407, 6.446, 4.662
Level Sweep.....	6.729, 4.85
Level user correction.....	6.669, 4.61
LevelSweep.....	9.2
LF Gen Frequency.....	6.699, 4.95
LF Gen Voltage.....	6.704, 4.95
LF generator.....	6.698, 4.94
LF output.....	6.698, 1.6, 4.94
LF Output State.....	6.700, 4.95
LF Sweep.....	6.700, 4.93
LF Sweep.....	9.2
Licence for software option.....	4.10
Limit - Level.....	6.727, 4.51
Link Direction - 3GPP FDD.....	6.493, 4.324
Link Direction - CDMA2000.....	6.121, 4.549
Link Direction - TD-SCDMA.....	6.325, 4.751
Link Direction - WiMAX.....	6.386, 4.660
Linux controller.....	1.33
List Management - DM.....	4.177
List mode.....	6.704, 6.729, 4.67
List mode - manual processing of lists.....	4.71
List Mode Data.....	4.74
List Range In.....	6.712, 6.713, 4.76
ListMode.....	9.3
Lists not same length (-226).....	9.7
Load Almanac File - GPS.....	6.241, 4.727
Load GSM settings.....	4.265
Load instrument settings.....	6.6, 6.26, 4.27
Load TD-SCDMA Settings.....	4.749
Load Waveform - ARB.....	6.90, 6.91, 4.211
Local to remote switchover.....	5.3
Lock keyboard.....	6.751
Long Code Mask - CDMA2000.....	4.534
Long Scrambling Code - UE - 3GPP FDD.....	6.621, 4.418
Longitude - GPS.....	4.725
Longitude (Degrees) - GPS.....	6.225
Longitude (Direction) - GPS.....	6.225
Longitude (Minutes) - GPS.....	6.225
Longitude (Seconds) - GPS.....	6.225
Lower case.....	6.1
Lower-case (commands).....	5.14

## M

M sequence.....	4.311
MAC Header State - WiMAX.....	6.415, 6.436, 4.679, 4.705
Mantissa.....	5.16
Manual control switch-over.....	4.21
Manual operation.....	
return to.....	5.4, 5.10
Manual Step Dyn Power Control - BS1 - 3GPP FDD.....	6.559
Manual Step Dyn Power Control - UE1 - 3GPP FDD.....	6.631
Manual Trigger - 3GPP FDD.....	6.498, 4.340
Manual Trigger - ARB.....	6.75, 4.218
Manual Trigger - CDMA2000.....	6.127, 4.563
Manual trigger - DM.....	6.201, 4.184
Manual Trigger - GPS.....	6.231, 4.735
Manual trigger - GSM/EDGE.....	6.279, 4.267
Manual Trigger - MCCW.....	6.307, 4.255
Manual Trigger - TD-SCDMA.....	6.331, 4.764
Manual Trigger - WiMAX.....	6.392, 4.711
Manual Trigger - WLAN.....	6.465, 4.645
Manually remote control.....	1.28
Map output connector user x to.....	4.18
Marker - TD-SCDMA.....	4.752
Marker CH x - ARB.....	6.81
Marker Channel x - DM.....	6.205, 4.202
Marker Channel x - MCCW.....	6.311, 4.257
Marker Configuration - Test Case Wizard - 3GPP.....	
.....	6.656, 4.487
Marker Delay - 3GPP FDD.....	6.501, 4.344
Marker Delay - ARB.....	6.78, 4.225
Marker Delay - CDMA2000.....	6.129, 4.566
Marker Delay - DM.....	6.203, 4.203
Marker Delay - GPS.....	6.232, 4.739
Marker Delay - GSM/EDGE.....	6.282, 4.289
Marker Delay - MCCW.....	6.309, 4.258
Marker Delay - TD-SCDMA.....	6.333, 4.766, 4.767
Marker Delay - WiMAX.....	6.394, 4.715
Marker Delay - WLAN.....	6.467, 4.648
Marker Mode - 3GPP FDD.....	6.500, 4.342
Marker Mode - CDMA2000.....	6.131, 4.564
Marker Mode - GPS.....	6.234, 4.737
Marker Mode - GSM/EDGE.....	6.284, 4.287
Marker Mode - TD-SCDMA.....	6.334, 4.765
Marker Mode - WiMAX.....	6.396, 4.713
Marker Mode - WLAN.....	6.468, 4.647
MARKEr output.....	1.9, 1.10, 4.18
Marker output signals.....	4.161
Marker Period - 3GPP FDD.....	6.503, 4.343
Marker Period - CDMA2000.....	6.132, 4.565
Marker Period - GSM/EDGE.....	6.286, 4.287
Marker Period - TD-SCDMA.....	6.335, 4.766
Marker Positions - DM.....	4.194
Marker Positions - GSM/EDGE.....	4.307
Maximal deviation - FM.....	6.678, 4.107
Maximal deviation - PhiM.....	4.111
Maximal deviation - PM.....	6.721
Maximum Information Bitrate/kbps - HSUPA FRC - 3GPP FDD.....	6.596, 4.466
Measured External Clock - 3GPP FDD.....	4.345
Measured External Clock - ARB.....	4.226
Measured External Clock - CDMA2000.....	4.567
Measured External Clock - DM.....	4.205
Measured External Clock - GPS.....	4.740
Measured External Clock - GSM/EDGE.....	4.291
Measured External Clock - MCCW.....	4.260
Measured External Clock - TD-SCDMA.....	4.768
Measured External Clock - WiMAX.....	4.716
Measured External Clock - WLAN.....	4.650
Menu area.....	3.15
Menu header.....	3.14
Message Length - TD-SCDMA.....	6.373, 4.792
Message Length PCPCH - UE - 3GPP FDD.....	6.606, 4.438
Message Length PRACH - UE - 3GPP FDD.....	6.615, 4.429



Method for compressed mode - BS - 3GPP FDD..... 6.539, 4.357  
 Method for compressed mode - UE - 3GPP FDD..... 6.579, 4.420  
 Midamble Code ID - TD-SCDMA..... 6.342, 4.771  
 Midamble Repetition - WiMAX..... 6.436, 4.669  
 Midamble Shift - TD-SCDMA..... 6.369, 6.374, 4.788, 4.793  
 Minimum Noise/System Bandwidth Ratio - AWGN..... 6.45, 4.137  
 Missing parameter (-109)..... 9.7  
 Mixed-Feld - GSM/EDGE..... 6.261, 4.302  
 Mobile station default values - CDMA2000..... 6.181, 4.552  
 Mod Frequency Offset - Test Case Wizard - 3GPP..... 6.649, 6.650, 4.518  
 Mod Interferer Level - Test Case Wizard - 3GPP..... 6.649, 4.518  
 Mod Interferer State - Test Case Wizard - 3GPP..... 6.650, 4.518  
 MOD OFF..... 9.1  
 MOD OFF line..... 4.54  
 Mode - FM..... 6.679, 4.106  
 Mode - I/Q out..... 6.697  
 Mode - Level Sweep..... 6.729, 6.741, 4.86  
 Mode - LF Gen..... 6.699, 4.91  
 Mode - LF Sweep..... 6.699, 6.701, 4.91  
 Mode - List Mode..... 6.714, 4.71  
 Mode - PhiM..... 4.110  
 Mode - PM..... 6.722  
 Mode - RF Frequency..... 6.684, 4.80  
 Mode - RF Sweep..... 6.684, 6.738, 4.80  
 Mode - UE - 3GPP FDD..... 6.603, 4.416  
 Mode Dyn Power Control BS1 - 3GPP FDD..... 4.394  
 Mode Dyn Power Control UE1 - 3GPP FDD..... 4.479  
 Mode Framed (double) - GSM/EDGE..... 6.273, 4.272  
 Mode Framed (single) - GSM/EDGE..... 6.273, 4.270  
 Mode Import/Export - List Mode data..... 6.710, 4.77  
 Mode Import/Export - User Correction data..... 6.676, 4.66  
 Mode Unframed - GSM/EDGE..... 6.273, 4.268  
 Modulation - AM..... 6.40, 4.97  
 Modulation - BB-AM..... 6.41, 4.101  
 Modulation - CDMA2000..... 4.601  
 Modulation - DM..... 4.181  
 Modulation - FM..... 6.678, 4.104  
 Modulation - I/Q..... 6.691, 6.694, 4.115  
 Modulation - PhiM..... 4.108  
 Modulation - PM..... 6.721  
 Modulation - Pulse modulation..... 6.732, 4.102  
 Modulation and Coding Rate - WiMAX..... 4.690  
 Modulation and RS-CC Rate - WiMAX .. 6.413, 6.434, 4.669  
 Modulation data - BS - 3GPP FDD..... 6.517, 4.370  
 Modulation data - BS - CDMA2000..... 6.149, 4.585  
 Modulation data external..... 4.153  
 Modulation Delay for ext. Data - DM..... 6.194, 4.182  
 Modulation depth - AM..... 6.41, 4.99  
 Modulation depth - PhiM..... 4.111  
 Modulation deviation - FM..... 6.678, 4.107  
 Modulation deviation - PM..... 6.721  
 Modulation input..... 1.7  
 Modulation Type - DM..... 6.193, 4.180  
 Modulation Type - GSM/EDGE..... 6.258, 4.278  
 Modulation Type EDGE - GSM/EDGE..... 6.257, 4.279  
 MONITOR connector..... 1.8  
 More Params - CDMA2000..... 4.587  
 More Params F-PDCH- CDMA2000..... 4.596  
 MSK Modulation - GSM/EDGE..... 6.258, 4.278  
 Multi Channel Assistant - BS - 3GPP FDD..... 4.409  
 Multicarrier CW..... 6.294, 4.245  
 Multi-Carrier Waveforms - ARB..... 4.234  
 Multicode State - DPCC BS - 3GPP FDD..... 6.518, 4.398  
 Multiple Chip Clock Mode - TD-SCDMA..... 4.767  
 Multiplier - 3GPP FDD..... 6.488, 4.345  
 Multiplier - ARB..... 6.59, 4.226  
 Multiplier - CDMA2000..... 6.113, 4.567

Multiplier - DM..... 6.189, 4.205  
 Multiplier - GPS..... 6.222, 4.740  
 Multiplier - GSM/EDGE..... 6.256, 4.291  
 Multiplier - MCCW..... 6.301, 4.259  
 Multiplier - TD-SCDMA..... 6.320, 4.768  
 Multiplier - WiMAX..... 6.381, 4.716  
 Multiplier - WLAN..... 6.452, 4.650  
 Multisegment table - ARB..... 4.229  
 Multi-Segment Waveforms - ARB..... 4.228  
 Multislot Configuration State - GSM/EDGE..... 6.259, 4.297  
 Multi-transmitter measurements..... 4.55

## N

Network card..... 1.20  
 Network drives..... 1.26  
 New list- ARB..... 4.232, 4.233  
 Next Segment - ARB..... 4.218  
 No current list (241)..... 9.12  
 No error (0)..... 9.7  
 No. of Bursts - WiMAX..... 6.409, 6.431, 4.667  
 No. of Symbols - WiMAX..... 4.686  
 No. of used Subchannels - WiMAX..... 6.447, 4.667  
 No. of Zones/Segments- WiMAX..... 6.421, 4.683  
 Noise Bandwidth - AWGN..... 6.45, 4.138  
 Noise generator..... 6.44, 4.135  
 Noise generator, switching on..... 4.136  
 Noise level - AWGN..... 6.50, 4.142  
 Noise level Total Bandwidth - AWGN..... 6.50, 4.143  
 Noise Only..... 6.48, 4.136  
 No-load voltage (EMF)..... 4.55  
 Nominal Average Information Bitrate - BS - 3GPP FDD..... 6.529, 4.376  
 NORMAL (Half Rate) Burst - GSM/EDGE..... 6.261, 4.293  
 NORMAL Burst - GSM/EDGE..... 6.261, 4.293  
 Norton Antivirus 2005..... 1.40  
 Number of 32-Chip Walsh Channels - BS - CDMA2000..... 4.601  
 Number of 32-Chip Walsh Channels - BS - CDMA2000..... 4.601  
 Number of additional MS - CDMA2000..... 6.173, 4.571  
 Number of additional UE - 3GPP FDD..... 6.574, 4.351  
 Number Of Allocated Codes - WiMAX..... 4.704  
 Number of Bits per Encoder Packet - CDMA2000..... 6.164, 4.600  
 Number of Carriers - ARB MCAR..... 4.236  
 Number of Carriers - ARB MCARr..... 6.60  
 Number of Carriers - MCCW..... 6.295, 4.247  
 Number of channels..... 4.743  
 Number of Data Symbols - WLAN..... 6.482, 4.632  
 Number of Dedicated Channels - TD-SCDMA..... 6.339, 4.769  
 Number of DPCH - Predefined Settings 3GPP FDD..... 6.507, 4.350  
 Number of DPCHs - TD-SCDMA..... 6.339, 4.769  
 Number of HARQ Processes - BS - 3GPP FDD..... 6.528, 4.376  
 Number Of HARQ Processes - HSUPA FRC - 3GPP FDD..... 6.596, 4.467  
 Number of H-PDSCH Channel Codes - BS - 3GPP FDD..... 6.527, 4.376  
 Number of licences..... 4.10  
 Number of PI per Frame - BS - 3GPP FDD..... 6.544, 4.354  
 Number of Slots - GSM/EDGE..... 6.259, 4.297  
 Number of Slots - WiMAX..... 6.418, 4.691  
 Number of Slots per Subpacket - CDMA2000..... 4.601  
 Number of Subchannel Groups - WiMAX..... 4.704  
 Number of Subchannels - WiMAX..... 6.419  
 Number of Supplemental Channels - Predef - CDMA2000..... 6.141, 4.569  
 Number of Symbols - WiMAX..... 6.419, 6.437, 4.670, 4.691  
 Number of Sync Shift - TD-SCDMA..... 6.365, 4.789  
 Number of TFCI Bits - TD-SCDMA..... 6.366, 4.788  
 Number of TPC Bits - TD-SCDMA..... 4.789

Number of Traffic Channels - Predef - CDMA2000 .....	6.139, 4.569
Number of User .....	6.371
Number of Users - TD-SCDMA .....	6.375, 4.793
Number of Users - TD-SCDMA .....	6.344
Number of Users - TD-SCDMA .....	4.772
Number of Users - TD-SCDMA .....	4.793
Numeric data not allowed (-128) .....	9.7
Numeric suffix .....	5.13
Nyquist filter - 3GPP FDD .....	6.493, 4.332
Nyquist filter - CDMA2000 .....	6.120, 4.555
Nyquist filter - TD-SCDMA .....	6.324, 4.756
Nyquist filter - WLAN .....	6.456

## O

OCNS Mode - BS - 3GPP FDD .....	6.543, 4.327
Offset - Frequency .....	6.684, 4.45
Offset - I/Q analog .....	6.692, 4.116
Offset - I/Q out .....	6.697, 4.127
Offset - Level .....	6.726, 4.52
Offset Symbol - WiMAX .....	6.427, 4.687
ON/OFF Ratio Marker - 3GPP FDD .....	6.502, 4.343
ON/OFF Ratio Marker - ARB .....	6.82, 4.224
ON/OFF Ratio Marker - CDMA2000 .....	6.131, 4.565
ON/OFF Ratio Marker - DM .....	6.205, 4.203
ON/OFF Ratio Marker - GPS .....	6.235, 4.738
ON/OFF Ratio Marker - GSM/EDGE .....	6.285, 4.288
ON/OFF Ratio Marker - MCCW .....	6.311, 4.258
ON/OFF Ratio Marker - TD-SCDMA .....	6.335, 4.766
ON/OFF Ratio Marker - WiMAX .....	6.396, 4.714
ON/OFF Ratio Marker - WLAN .....	6.469, 4.648
On/off switch .....	1.2
OPC A output .....	1.11
Open File Manager .....	4.749
Operating Band - Test Case Wizard - 3GPP .....	6.665, 4.513
Operating Mode - MS - CDMA2000 .....	6.181, 4.603
Operation hours .....	6.17, 4.8
Opportunity Size - WiMAX .....	6.417, 4.703
Opportunity Slot Count - WiMAX .....	6.418
Opportunity Subchannel groups - WiMAX .....	6.418
Optimization mode .....	4.134
Optimize Crest Factor - ARB MCAR .....	6.64, 4.237
Optimize Crest Factor - MCCW .....	6.299, 4.248
Optimize Filter For - WiMAX .....	4.707
Optimize I/Q-Signals for RF Output .....	6.696, 4.124
Optimize internal I/Q-Impairments for RF Output .....	6.291, 4.134
Option	
ARB-Baseband Generator (B9/B10/B11) .....	4.206
Baseband Generator (B10/B11) .....	4.144
Baseband Main Module (B13) .....	4.144
Digital Standard GSM/EDGE (K40) .....	4.260
DM-Baseband Generator (B10/B11) .....	4.162
expiration date .....	4.10
listing .....	6.5, 4.9
Multicarrier CW (K61) .....	4.245
SMATE-B31, High Power, path A .....	4.52, 4.70, 4.86
SMATE-B36, High Power, path B .....	4.52, 4.70, 4.86
Option - R&S SMATE-B16 (Differential Output) .....	4.124
Option Additional White Gaussian Noise, K62 .....	2.3
Option Baseband Generator, B10/B11 .....	2.3
Option Baseband Input, B17 .....	1.6
Option Baseband main modul, B13 .....	2.3
Option FM/PhiM Modulator and Low Phase Noise, B22 .....	2.4
Option High-power, B31/B36 .....	2.4
Options - TD-SCDMA .....	4.768
Options Frequency, B103/B106/B203/B206 .....	2.4
Options, floating licence .....	2.3
Options, installation .....	1.12
Order Code Domain - BS - CDMA2000 .....	6.162, 4.578
Out of memory (-225) .....	9.7

Output - BITCLK .....	1.9, 4.18
Output - BURST .....	1.9, 4.18
Output - CLOCK .....	1.6
Output - DATA .....	1.9, 1.11, 4.18
Output - I OUT .....	1.6
Output - I OUT BAR .....	1.6
Output - LEV-ATT .....	1.8, 4.17
Output - LF .....	6.698, 1.6, 4.94
Output - MARKER 1 .....	1.10
Output - MARKER 2 .....	1.10
Output - MARKER 4 .....	1.9, 4.18
Output - OPC A .....	1.11
Output - Q OUT .....	1.6
Output - Q OUT BAR .....	1.6
Output - REF OUT .....	1.5
Output - RF .....	1.4
Output - SYMBCLK .....	1.9, 4.18
Output File - ARB .....	4.231
Output File - ARB MCAR .....	4.243
Output Mode - IQ Out .....	4.125
Output Type - IQ out .....	6.697
OvenCold .....	9.3
Overall Symbol Rate - UE1 - 3GPP FDD .....	6.632, 4.474
Overall Symbol Rate DPDCH - Test Case Wizard - 3GPP .....	6.664, 4.492
Overall Symbol Rate DPDCH - UE- 3GPP FDD .....	6.582, 4.456
Overall Symbol Rate E-DPDCH - UE- 3GPP FDD .....	6.601, 4.462
Overlapping execution .....	5.20
OVERLOAD .....	9.1
Overwrite Cell Settings - TD-SCDMA .....	6.321, 4.754

## P

Packet Interval - BS - CDMA2000 .....	6.163, 4.597
Packet Setup - BS - CDMA2000 .....	6.164, 4.598
Parallel Poll .....	5.26
Parameter (commands) .....	5.16
Parameter not allowed (-108) .....	9.7
Part numbers .....	4.8
Paste .....	4.29
Paste - Data Editor .....	4.189
Path - Test point .....	4.11
Path Gain - Baseband .....	6.54, 4.148
Path reset .....	6.8
Pattern - BS - 3GPP FDD .....	6.517, 4.370
Pattern - BS - CDMA2000 .....	6.149, 4.585
Pattern - CDMA2000 .....	4.586, 4.611
Pattern - DM .....	6.194, 4.176
Pattern - GSM/EDGE .....	6.265, 4.270, 4.298
Pattern - MS - CDMA2000 .....	6.176, 6.177, 4.610
Pattern - TD-SCDMA .....	4.786
Pattern - WLAN .....	4.633
Pattern Length - BS - 3GPP FDD .....	6.540, 4.361
Pattern Length - UE - 3GPP FDD .....	6.580, 4.423
P-CCPCH State - TD-SCDMA .....	6.360, 4.773
PCI bus .....	4.8
PCPCH only - UE - 3GPP FDD .....	6.603, 4.417, 4.432
PCPCH Settings .....	4.432
Peak envelope power PEP .....	3.8
Peak level of baseband .....	6.315, 4.134
PermBase - WiMAX .....	6.424, 4.687
Phase - RF output signal .....	6.720, 4.46
Phase Offset - Baseband .....	6.54, 4.148
Phase Offset Q - Test Signal ARB .....	6.86, 4.228
Phase Start - ARB MCAR .....	6.62, 4.240
Phase Start - MCCW .....	6.296, 6.297, 4.249
Phase Step - ARB MCAR .....	6.67, 4.240
Phase Step - MCCW .....	6.303, 4.250
PhiM Depth .....	4.111
PhiM External Coupling .....	4.111
PhiM External Impedance .....	6.689, 4.112

PhiM Frequency	4.112	Power/dB - BS - CDMA2000	6.154, 4.585
PhiM Mode	4.110	Power/dB - MS - CDMA2000	6.178, 4.610
PhiM Sensitivity	4.111	Power/dB - TD-SCDMA	6.369, 4.785
PhiM Source	4.110	Power-On Counter	6.17, 4.8
PhiM State	4.110	Power-On State	6.33, 4.54
Physical channels	4.743	PowMp - PCPCH - UE - 3GPP FDD	4.434
Pilot Length - DPCCH BS - 3GPP FDD	6.518, 4.398	PowMp - PRACH - UE - 3GPP FDD	4.426
PLCP P+H Format (CCK,PBCC) - WLAN	6.457, 4.630	PowMpControl - PRACH - UE - 3GPP FDD	6.617, 4.426
PM Deviation	6.721	PowMpData - PRACH - UE - 3GPP FDD	6.617, 4.426
PM External Coupling	6.721	PowPre - PCPCH - UE - 3GPP FDD	6.609, 4.434
PM Frequency	6.699, 4.103	PowPre - PRACH - UE - 3GPP FDD	6.618, 4.426
PM Mode	6.722	PPE (Parallel poll enable register)	5.25
PM Sensitivity	6.722	PRACH - TD-SCDMA	4.782
PM Source	6.723	PRACH Data Source - TD-SCDMA	6.364, 6.373, 4.793
PM State	6.723	PRACH Message Part Power - TD-SCDMA	6.374, 4.793
PN Offset - BS - CDMA2000	6.169, 4.534, 4.575	PRACH only - UE - 3GPP FDD	6.603, 4.416, 4.424
Point-to-point connection	1.21, 1.27	PRACH Select Data List - TD-SCDMA	6.373
Polarity - No signal (blank) marker	6.31, 4.19	PRACH Settings	4.424
Polarity - Pulse Modulation	6.732, 4.104	PRACH Slot Mode - TD-SCDMA	6.372, 4.782
Power - List mode	4.74	PRACH Spreading Factor - TD-SCDMA	6.374, 4.793
Power - Multichannel BS - 3GPP FDD	4.411	PRBS - GSM/EDGE	4.270, 4.298
Power class- Test Case Wizard - 3GPP	6.644, 4.489	PRBS generator	4.151
Power Control BS1 - 3GPP FDD	6.558, 4.394	PRBS Type - DM	6.197, 4.176
Power Control Grap - Ext. Power Control UE1 - 3GPP FDD	6.629, 4.480	PRBS Type - WLAN	4.632
Power Control Preamble Length PCPCH - UE - 3GPP FDD	6.606, 4.437	PRBS_ID - WiMAX	6.424, 4.687
Power Control UE1 - 3GPP FDD	6.630, 4.479	Preamble Index - WiMAX	6.407, 4.684
Power Down Steps - Test Case Wizard - 3GPP	6.661, 4.494	Preamble Mode - WiMAX	6.408, 4.684
Power DPCCH - UE - 3GPP FDD	6.587, 4.444	Preamble Power PCPCH - UE - 3GPP FDD	6.607, 4.437
Power E-DPCCH - UE - 3GPP FDD	6.592, 4.448	Preamble Power PRACH - UE - 3GPP FDD	6.615, 4.427
Power E-DPDCH - UE - 3GPP FDD	6.601, 4.462	Preamble Power Step PCPCH - UE - 3GPP FDD	6.607, 4.437
Power Level - Test Case Wizard - 3GPP	6.666, 4.492, 4.504	Preamble Power Step PRACH - UE - 3GPP FDD	6.615, 4.428
Power of starting carrier - ARB MCAR	4.240	Preamble Repetition PCPCH - UE - 3GPP FDD	6.607, 4.437
Power of starting carrier - ARB MCARrier	6.62	Preamble Repetition PRACH - UE - 3GPP FDD	6.616, 4.428
Power of starting carrier - MCCW	6.296, 6.297, 4.249	Predefined Settings - TD-SCDMA	4.754, 4.768
Power Offset - Additional MS - CDMA2000	6.174, 4.572	Preset	1.16
Power Offset - Additional UE - 3GPP FDD	6.574, 4.352	Preset - instrument settings	6.6, 6.8, 6.751, 4.4
Power Offset - BS - 3GPP FDD	4.360	Priorisation of Systematic Bits - BS - 3GPP FDD	6.530, 4.377
Power Offset - UE - 3GPP FDD	4.421	Priorisation Of Systematic Bits - s - TD-SCDMA	6.353, 4.778
Power Offset ACK - HS-DPCCH - UE - 3GPP FDD	6.585, 4.452	Program mnemonic too long (-112)	9.8
Power Offset Mode - BS - 3GPP FDD	6.541, 6.542, 4.359	Propagation Delay - Test Case Wizard - 3GPP	6.668, 4.493
Power Offset Mode - UE - 3GPP FDD	6.581, 4.421	Protection	4.20
Power Offset NACK - HS-DPCCH - UE - 3GPP FDD	6.586, 4.453	PSK	4.162
Power Offset Pilot - DPCCH BS - GPP3	6.519, 4.402	Pulse Divider Marker - ARB	6.83, 4.224
Power Offset TFCI - DPCCH BS - GPP3	6.519, 4.402	Pulse Divider Marker - DM	6.206, 4.202
Power Offset TPC - DPCCH BS - GPP3	6.519, 4.402	Pulse Divider Marker - GPS	6.236, 4.738
Power Ramp Control - GSM/EDGE	4.279	Pulse Divider Marker - GSM/EDGE	6.286, 4.288
Power ramping	4.159	Pulse Divider Marker - MCCW	6.312, 4.257
Power ramping - DM	6.196, 4.195	Pulse Divider Marker - WiMAX	6.397, 4.713
Power Ramping - TD-SCDMA	4.752	Pulse Divider Marker - WLAN	6.470, 4.647
Power Ratio DPCCH/DPDCH - Test Case Wizard - 3GPP	6.657, 4.493	Pulse External Impedance	6.689, 4.104
Power spectrum	4.41	Pulse Frequency Marker - ARB	6.83, 4.224
Power Start - ARB MCARrier	6.62	Pulse Frequency Marker - DM	6.207, 4.202
Power Start - MCCW	6.296, 6.297, 4.249	Pulse Frequency Marker - GPS	6.236, 4.738
Power Step - ARB MCAR	6.68	Pulse Frequency Marker - GSM/EDGE	6.287, 4.288
Power Step - BS - CDMA2000	6.158, 4.591	Pulse Frequency Marker - MCCW	6.313, 4.257
Power Step - MCCW	6.303, 4.249	Pulse Frequency Marker - WiMAX	6.398, 4.713
Power Step - MS - CDMA2000	6.184, 4.607	Pulse Frequency Marker - WLAN	6.470, 4.647
Power Step - Multichannel BS - 3GPP FDD	4.411	Pulse modulation	6.732, 4.102
Power Step - TD-SCDMA	6.376, 4.792	Pulse modulation - repetition frequency	6.699, 4.103
Power Step BS1 - 3GPP FDD	6.558, 4.395	Puncturing - BS - 3GPP FDD	6.539, 4.357
Power Step TPC - DPCCH BS - GPP3	6.522, 4.401, 4.405	Puncturing - UE - 3GPP FDD	6.579
Power Step TPC - F-DPCH BS - GPP3	6.526	Puncturing and Repetition Scheme - BS - 3GPP FDD	6.530, 4.377
Power Step TPC DPCCH - UE - 3GPP FDD	6.590, 4.448	Puncturing And Repetition Scheme - r - TD-SCDMA	6.353, 4.778
Power Step UE1 - 3GPP FDD	6.630, 4.480		
Power Up Steps - Test Case Wizard - 3GPP	6.662, 4.494		
Power Viewer	1.17		
Power/dB - BS - 3GPP FDD	6.536, 4.370		

## Q

Q input	1.6
Q OUT	1.6
Q OUT BAR	1.6
QAM	4.162
Quadrature Offset - I/Q analog	6.693, 4.119
Quadrature Offset - I/Q digital	6.291, 4.133
Quasi Orthogonal Walsh Set - BS - CDMA2000	6.170, 4.575
Quasi Orthogonal Walsh Set - CDMA2000	4.534
Quasi Orthogonal Walsh Set State - BS - CDMA2000	6.155, 4.585
Query	5.11
responses	5.15
Query deadlocked (-430)	9.8
Query interrupted (-410)	9.8
Query unterminated (-420)	9.8
Question	5.18
Queue overflow (-350)	9.8
Quotation marks	5.18

## R

RACH Message Length - TD-SCDMA	6.373, 4.792
RACH State - TD-SCDMA	6.375, 4.792
Rack installation	1.12
Radio Configuration - BS - CDMA2000	6.161, 4.583
Radio Configuration - MS - CDMA2000	6.182, 4.604
Radio Configuration - Predef - CDMA2000	6.138, 4.568
Radio Frame Marker - TD-SCDMA	4.765
Ramp Function - DM	6.195, 4.196
Ramp Function - GSM/EDGE	6.274, 4.280
Ramp Function - TD-SCDMA	6.327, 4.760
Ramp Time - DM	6.196, 4.196
Ramp Time - GSM/EDGE	6.274, 4.280
Ramp Time - TD-SCDMA	6.327, 4.760
Randomizer - WiMAX	6.410
Ranging Code - GPS	6.250, 4.730
Ranging Opportunity Size - WiMAX	6.417
Ranging Opportunity Slot Count - WiMAX	6.418
Ranging Opportunity Subchannel Groups - WiMAX	6.418
Rate Matching Attribute - BS1 - 3GPP FDD	6.563, 4.389
Rate Matching Attribute - TD-SCDMA	6.351, 6.358, 4.781
Rate Matching Attribute - UE1 - 3GPP FDD	6.635, 4.476
Ratio Noise/System Bandwidth - AWGN	6.45, 4.137
Read Out Mode - BS - CDMA2000	6.159, 4.589
Read Out Mode - DPCC BS - GPP3	6.523, 4.399
Read Out Mode - F-DPCC BS - GPP3	6.526, 4.404
Read Out Mode - MS - CDMA2000	6.185, 4.606
Read Out Mode - TD-SCDMA	6.368, 4.790
Read Out Mode DPCC - UE - 3GPP FDD	6.591, 4.446
Read Out Mode PCPC - UE - 3GPP FDD	6.612, 4.440
READY LED	1.2
Real Time - BS - CDMA2000	6.155, 4.583
Recall Configuration - TD-SCDMA	4.749
Recall instrument settings	6.6, 6.26, 4.27, 4.28
Recall Intermediate	6.6, 4.28
Recall TD-SCDMA Settings	4.749
Recent data sets	4.27
Redundancy Version Parameter - BS - 3GPP FDD	6.531, 4.376
Redundancy Version Parameter - TD-SCDMA	6.353, 4.778
REF IN	1.5
REF OUT	1.5
REF OUT output	4.47
Reference frequency - external	6.734, 4.48
Reference frequency adjustment mode	6.735, 4.48
Reference Level - AWGN	4.139
Reference Measurement Channel - Test Case Wizard - 3GPP	6.662, 4.504
Reference measurement channel coding types	6.552, 4.384

Reference Mode - AWGN	6.51
Reference oscillator	6.734, 4.47
REM LLO	9.2
REMOTE	9.2
Remote control - Ethernet/LAN	5.5
Remote control - GPIB	5.4
Remote control - manually	1.28
Remote control basics	5.1
Remote control switchover	5.3
Remote Desktop Connection	1.28
REMOTE LED	1.2
Remote to local switchover	5.3
Rename	6.27, 4.29
Repetition of Frame 1   2 - GSM/EDGE	6.260, 4.274
Required BLER - Test Case Wizard - 3GPP	6.643, 4.523, 4.531
Required Pd - Test Case Wizard - 3GPP	6.643, 4.528
Reset - Instrument settings	1.16
Reset All Base Stations - 3GPP FDD	6.544, 4.329
Reset All Base Stations - CDMA2000	6.169, 4.552
Reset All Cells - TD-SCDMA	6.328, 4.753
Reset All Mobile Stations - CDMA2000	6.181, 4.552
Reset All User Equipment - 3GPP FDD	4.329
Reset Delta Phase Display	6.720, 4.46
Reset device parameters	6.8
Reset instrument settings	6.6, 6.8, 6.751, 4.4
Reset path	6.8
Reset status reporting system	5.27
Resource Units On Physical Layer - TD-SCDMA	6.354, 4.775
Restoring the previous value	3.24
Resulting CW Frequency - AWGN	6.48, 4.138
Resulting Frequency - GPS	6.249, 4.731
Resulting P Chip Rate - GPS	6.249, 4.732
Resulting Resulting C/A Chip Rate - GPS	6.248
Resulting Walsh Code for Subpacket - BS - CDMA2000	6.168, 4.601
ResultingC/A Chip Rate - GPS	6.249, 4.732
Retransmission Sequence Number - E-DPCCH - UE - 3GPP FDD	6.592, 4.449
Retrigger - 3GPP FDD	6.495, 4.338
Retrigger - ARB	6.74, 4.220
Retrigger - CDMA2000	6.124, 4.561
Retrigger - DM	6.198, 4.199
Retrigger - GPS	6.227, 4.733
Retrigger - GSM/EDGE	6.277, 4.283
Retrigger - MCCW	6.306, 4.254
Retrigger - TD-SCDMA	6.328
Retrigger - WiMAX	6.388, 4.710
Retrigger - WLAN	6.460, 4.643
Revisions	4.8
RF frequency	6.681, 6.682, 4.45
RF Frequency - Test Case Wizard - 3GPP	6.664, 4.492
RF OFF	9.1
RF OFF line	4.54
RF ON A/B LED	1.2
RF ON/OFF key	6.33, 4.42
RF output - Power-on state	6.33, 4.54
RF output level	6.726, 4.51
RF output signal - Phase adjustment	6.720, 4.46
RF outputs	1.4
RF Power - Test Case Wizard - 3GPP	6.666, 4.492, 4.504
RF section	2.4
RFI signal generator, switching on	4.136
RFSweep	9.2
Rise Delay - DM	6.195, 4.196
Rise Delay - TD-SCDMA	6.326, 4.760
Rise Offset - WiMAX	4.714
Rise Offset - GSM/EDGE	6.274, 4.280
Rise Offset Marker - WiMAX	6.398
RJ-45 cable	1.20
Roll Off - 3GPP FDD	6.491, 4.333
Roll Off - CDMA2000	6.118, 4.556

Roll Off - TD-SCDMA.....	6.323, 4.757
Roll Off - WLAN.....	6.454
Roll off factor - DM.....	6.191, 4.183
Route to path A/B.....	6.55, 4.148
Running - Trigger - 3GPP FDD.....	6.503, 4.339
Running - Trigger - ARB.....	6.84, 6.85, 4.221
Running - Trigger - CDMA2000.....	6.133
Running - Trigger - DM.....	6.207, 4.200
Running - Trigger - GPS.....	6.237, 4.735
Running - Trigger - GSM/EDGE.....	6.287, 4.285
Running - Trigger - MCCW.....	6.313, 4.255
Running - Trigger - TD-SCDMA.....	6.336
Running - Trigger - Trigger - CDMA2000.....	4.562
Running - Trigger - Trigger - TD-SCDMA.....	4.763
Running - Trigger - WiMAX.....	4.711
Running - Trigger - WLAN.....	6.471, 4.645

## S

Same Packet Setup - BS - CDMA2000.....	6.164, 4.598
Sample clock - WiMAX.....	6.381, 4.716
Sample Clock Multiplier - ARB.....	4.226
Sample Clock Multiplier - MCCW.....	4.259
Sample Clock Multiplier - WiMAX.....	6.381, 4.716
Sample Rate Variation - WiMAX.....	6.390, 4.707
Sample-and-Hold mode.....	6.725, 4.55
Samples per Period - Test Signal ARB.....	6.87, 4.227
Sampling Rate - WiMAX.....	6.408, 6.447, 4.666, 4.683
Sampling Rate Variation - WLAN.....	6.453
Sampling ratio N - WiMAX.....	6.406, 6.446, 4.666, 4.683
Save 3GPP FDD settings.....	4.322
Save CDMA settings.....	4.547
Save Configuration - TD-SCDMA.....	4.749
Save GSM settings.....	4.266
Save immediate.....	6.6, 4.26
Save instrument settings.....	6.6, 6.28, 4.26
Save TD-SCDMA Settings.....	4.749
Save/Recall - ARB MCAR.....	4.236
Save/Recall - GSM/EDGE.....	4.264
Save-Recall - 3GPP FDD.....	4.321
Save-Recall - CDMA2000.....	4.546
SCPI - conformity information.....	6.1
SCPI - error messages.....	9.4
SCPI - version.....	5.1
Scrambler - WLAN.....	4.634
Scrambler Init (hex) OFDM - WLAN.....	6.459, 4.635
Scrambler OFDM - WLAN.....	4.634
Scrambling code.....	4.743
Scrambling Code - BS - 3GPP FDD.....	6.544, 4.354
Scrambling Code - TD-SCDMA.....	6.343, 4.771
Scrambling Code - TD-SCDMA.....	6.343
Scrambling Code - TD-SCDMA.....	4.771
Scrambling Code - UE - 3GPP FDD.....	6.620, 4.417
Scrambling Code (hex)- Test Case Wizard - 3GPP.....	6.653, 4.488
Scrambling Code Step - Additional UE - 3GPP FDD.....	6.574, 4.352
Scrambling Mode - Test Case Wizard - 3GPP.....	6.654, 4.488
Scrambling Mode - UE - 3GPP FDD.....	6.621, 4.418
Scrambling OFDM - WLAN.....	6.459
Search Once - ALC.....	6.725, 4.56
Segment #- ARB.....	4.229
Select Almanac File - GPS.....	6.241, 4.727
Select ASCII Destination - List Mode data.....	4.78
Select ASCII Destination - User Correction data.....	4.67
Select ASCII Source - User Correction data.....	4.67
Select Base Station - BS - 3GPP FDD.....	4.331
Select Base Station - BS - CDMA2000.....	4.554
Select Cell - BS - TD-SCDMA.....	4.755
Select List.....	6.716, 4.74
Select Mobile Station - MS - CDMA2000.....	4.554
Select Operation - File menu.....	4.25
Select Preset Type - DM.....	4.193
Select Ramp to Edit - DM.....	4.192
Select Ramp to Edit - GSM/EDGE.....	4.306
Select Slot - TD-SCDMA.....	4.772
Select Test Point.....	6.753, 4.11
Select TPC List - TD-SCDMA.....	6.366, 6.367, 4.789
Select User Equipment - UE - 3GPP FDD.....	4.331
Selection field.....	3.14
Self test.....	6.7, 6.753
Self-test failed ... (-330).....	9.8
Semicolon (separator).....	5.18
Sensor - Power Sensors.....	4.58
Sequence Configuration - WLAN.....	4.628
Sequence Control - WLAN.....	6.481, 6.482, 4.638
Sequence Length - PCPCH UE - 3GPP FDD.....	6.610
Sequence Length - PRACH UE - 3GPP FDD.....	6.619
Sequence Length - Trigger - WLAN.....	6.471
Sequence Length - UE - 3GPP FDD.....	4.427, 4.436
Sequence Length (ARB) - 3GPP FDD.....	6.497, 4.336
Sequence Length (ARB) - CDMA2000.....	6.126, 4.558
Sequence Length (ARB) - TD-SCDMA.....	6.330, 4.759
Serial bus.....	4.8
Serial number.....	6.5
Serial numbers.....	4.8
Serial poll.....	5.26
Service Field (hex) OFDM - WLAN.....	6.460, 4.635
Service Field Clock Bits (CCK,PBCC) - WLAN.....	6.458, 4.635
Service request (SRQ).....	6.6
Service Request (SRQ).....	5.26
Set acc. to Standard - DM.....	6.200, 4.177
Set Noise Level via.....	6.49, 4.139
Set to default - 3GPP FDD.....	4.321
Set to default - ARB.....	6.73, 4.210
Set to default - ARB MCAR.....	6.69, 4.235
Set to default - CDMA2000.....	6.123, 4.545
Set to default - DM.....	6.197, 4.173
Set to default - GSM/EDGE.....	6.275, 4.262
Set to default - MCCW.....	6.305, 4.246
Set to default - TD-SCDMA.....	6.327
Set to Default - TD-SCDMA.....	4.748
Set to default - WiMAX.....	6.388, 4.655
Set to default - WLAN.....	6.458
Set to default RF - GPS.....	6.227, 4.721
Setting not possible.....	3.15
Setting Parameters.....	3.16
Settings - TD-SCDMA.....	4.768
Settings conflict ... (-221).....	9.9
Setup.....	4.5
SF2 - BS - 3GPP FDD.....	4.358
SF2 - MS - 3GPP FDD.....	4.420
SF2 -BS - 3GPP FDD.....	6.539
SFN.....	4.380
SFN restart.....	4.380
Short Scrambling Code - UE - 3GPP FDD.....	6.621, 4.418
Show BCH Details - TD-SCDMA.....	4.774
Show Channel Details - TD-SCDMA.....	4.774, 4.775
Show Coding PCPCH - UE - 3GPP FDD.....	4.442
Show Coding PRACH - UE - 3GPP FDD.....	4.431
Show DCH Details - TD-SCDMA.....	4.775
Show Details - BS1 - 3GPP FDD.....	4.385
Show Details - UE1 - 3GPP FDD.....	4.472
Sign.....	5.16
Signal Duration - ARB MCAR.....	4.238
Signal Duration - Trigger - 3GPP FDD.....	6.504, 4.339
Signal Duration - Trigger - ARB.....	6.84, 4.221
Signal Duration - Trigger - CDMA2000.....	6.133, 4.562
Signal Duration - Trigger - DM.....	6.208
Signal Duration - Trigger - GPS.....	6.237, 4.734
Signal Duration - Trigger - GSM/EDGE.....	6.288, 4.284
Signal Duration - Trigger - TD-SCDMA.....	6.336, 4.763
Signal Duration - Trigger - WiMAX.....	6.399, 4.711
Signal Duration - Trigger - WLAN.....	6.444
Signal Duration - Trigger - MCCW.....	6.314, 4.254

Signal Duration Unit - Trigger - 3GPP FDD.....	6.504, 4.339
Signal Duration Unit - Trigger - ARB.....	6.85, 4.221
Signal Duration Unit - Trigger - CDMA2000.....	6.134, 4.562
Signal Duration Unit - Trigger - GPS.....	6.238, 4.734
Signal Duration Unit - Trigger - GSM/EDGE.....	6.288, 4.284
Signal Duration Unit - Trigger - TD-SCDMA.....	6.337, 4.763
Signal Duration Unit - Trigger - WiMAX.....	6.400, 4.711
Signal Duration Unit - Trigger - WLAN.....	6.472, 4.644
Signal Level (RMS).....	6.316, 4.134
Signal Period Mode - ARB MCAR.....	6.72, 4.238
Signal Routing - Baseband.....	4.148
Signature PCPCH - UE - 3GPP FDD.....	6.608, 4.437
Signature PRACH - UE -3GPP FDD.....	6.616, 4.428
Simulation Mode - GPS.....	6.229, 4.723
Simulation Mode - GSM/EDGE.....	6.278, 4.269
Sine Testsignals - ARB.....	4.227
Single Duration Unit - Trigger - WLAN.....	6.471
Size of CDC - TD-SCDMA.....	6.348, 6.356, 4.780
Size of CRC - BS1 - 3GPP FDD.....	6.560, 4.389
Size of CRC - UE1 - 3GPP FDD.....	6.632, 4.476
Slope - External baseband trigger.....	6.689, 4.14
Slope - Instrument trigger input.....	4.14
Slot Attenuation - GSM/EDGE.....	6.261, 4.281, 4.297
Slot Configuration - TD-SCDMA.....	4.772
Slot Count - WiMAX.....	6.418
Slot Format - BS - 3GPP FDD.....	6.537, 4.369
Slot Format - Multichannel BS - 3GPP FDD.....	4.410
Slot Format - TD-SCDMA.....	6.354, 6.360, 6.370, 4.778, 4.785, 4.788
Slot Format DPCCH - Test Case Wizard - 3GPP.....	6.657, 4.492
Slot Format DPCCH - UE - 3GPP FDD.....	6.587, 4.445
Slot Format Enhanced DPCH - BS1 -3GPP FDD.....	6.550, 4.386
Slot Format PCPCH - UE - 3GPP FDD.....	6.604, 4.438
Slot Format PRACH - TD-SCDMA.....	6.375, 4.793
Slot Format PRACH - UE - 3GPP FDD.....	6.616, 4.429
Slot Level - GSM/EDGE.....	6.263, 4.296
Slot Marker Definition - GSM/EDGE.....	4.303
Slot Mode - TD-SCDMA.....	6.372, 4.782
Slot Structure - TD-SCDMA.....	4.788
Slot Structure (DPCCH) - BS - 3GPP FDD.....	4.397
Slot Structure (F-DPCH) - BS - 3GPP FDD.....	4.402
Softkey.....	3.13
Software - compatibility.....	1.17
Software options.....	6.5, 4.9
Source - AM.....	6.42, 4.99
Source - FM.....	6.680, 4.106
Source - Level Sweep Trigger.....	6.757, 4.86
Source - LF Sweep Trigger.....	6.755, 4.91
Source - List Mode Trigger.....	6.717, 4.71
Source - PhiM.....	4.110
Source - PM.....	6.723
Source - Power Sensors.....	6.37, 4.59
Source - Pulse Modulation.....	6.733, 4.103
Source - Reference Oscillator.....	6.735, 4.48
Source - RF Sweep Trigger.....	6.756, 4.80
Source Bits / Frame - BS - CDMA2000.....	6.145, 4.593
Source Import/Export- List Mode data.....	6.711
Source Import/Export- User Correction data.....	6.676, 4.67
Source Power Ramp Control - DM.....	6.196, 4.195
Space-Time Coding Mode OFDMA - WiMAX.....	4.688
Space-Timing Coding Antenna OFDMA - WiMAX.....	6.425, 4.688
Space-Timing Coding Mode OFDMA - WiMAX.....	6.425
Spacing - Level Sweep.....	6.742, 4.89
Spacing - LF Sweep.....	6.702, 4.93
Spacing - RF Sweep.....	6.739, 4.83
Span (RF sweep).....	6.685, 4.83
Special characters.....	6.1
Specific interval usage code - WiMAX.....	6.413, 6.433
Spectrum display.....	4.41
Spread - MS - CDMA2000.....	6.178, 4.610
Spreading code.....	4.743
Spreading Code - TD-SCDMA.....	6.369, 4.785
Spreading code generator (search code).....	4.316
Spreading Code Number - BS - 3GPP FDD.....	6.516, 4.369
Spreading Code Number - BS - CDMA2000.....	6.161, 4.584
Spreading Code PRACH - TD-SCDMA.....	6.374, 4.793
Spreading Code Selection - TD-SCDMA.....	6.354, 6.359, 4.774, 4.776
Spreading Factor - TD-SCDMA.....	6.340, 6.370, 4.769, 4.785
Spreading Rate - CDMA2000.....	6.117, 4.534, 4.549
Square brackets.....	5.13
SRE (service request enable register).....	5.23
SRQ (service request).....	6.6
Standard - DM.....	6.200, 4.177
Standard settings - 3GPP FDD.....	4.321
Standard settings - ARB.....	4.210
Standard settings - ARB MCAR.....	4.235
Standard settings - CDMA2000.....	6.123, 4.545
Standard settings - DM.....	6.197, 4.173
Standard settings - GSM/EDGE.....	6.275, 4.262
Standard settings - MCCW.....	6.305, 4.246
Standard settings - TD-SCDMA.....	6.327
Standard Settings - TD-SCDMA.....	4.748
Standard settings - WiMAX.....	6.388, 4.655
Standard settings - WLAN.....	6.458
Standard settings RF - GPS.....	6.227, 4.721
Standby mode.....	1.2
Start Channel No - Multichannel BS - 3GPP FDD.....	4.409
Start Copy - TD-SCDMA.....	4.754
Start delay - ARB MCAR.....	6.60, 4.240
Start Delay m HS-DPCCH - UE - 3GPP FDD.....	6.586, 4.452
Start Freq.....	6.685, 4.82
Start Freq - LF Sweep.....	6.700, 4.93
Start Level.....	6.730, 4.88
Start menu - Windows XP.....	1.21
Start Number - WLAN.....	6.480, 6.481, 4.639
Start Offset PCPCH - UE - 3GPP FDD.....	6.609, 4.435
Start Offset PRACH - UE - 3GPP FDD.....	6.619, 4.426
Start phase - ARB MCAR.....	6.62, 4.240
Start phase - MCCW.....	6.296, 6.297, 4.249
Start Select - Data Editor.....	4.189
Start/Stop Gui Update.....	6.749, 4.9
Starting gain - ARB MCAR.....	4.240
Starting power - ARB MCARrier.....	6.62
Starting power - MCCW.....	6.296, 6.297, 4.249
State - 3GPP FDD.....	4.321
State - ALC.....	6.725, 4.56
State - analog Impairments.....	6.693, 4.116
State - ARB.....	6.74, 4.210
State - AWGN.....	6.52, 4.136
State - BS - 3GPP FDD.....	6.546, 4.354
State - BS - CDMA.....	6.170, 6.344
State - BS - CDMA.....	4.573
State - CDMA2000.....	6.126, 4.545
State - Cell - TD-SCDMA.....	4.770
State - Clipping - 3GPP FDD.....	4.333
State - Clipping - CDMA2000.....	6.113, 4.556
State - Clipping - TD-SCDMA.....	4.757
State - digital Impairments.....	6.292, 4.128
State - DM.....	4.173
State - GPS.....	6.230, 4.720
State - GSM/EDGE.....	6.278, 4.262
State - HSPA FRC - 3GPP FDD.....	6.597, 4.466
State - List Mode.....	6.684, 4.70
State - MAC - WiMAX.....	6.415, 6.436, 4.679, 4.705
State - MCCW.....	6.306, 4.246
State - MS - CDMA2000.....	6.182, 4.603
State - Power Sensors.....	4.58
State - Pulse Modulation.....	6.733, 4.103
State - Slot - TD-SCDMA.....	4.782
State - TD-SCDMA.....	6.330, 4.748
State - UE - 3GPP FDD.....	6.621, 4.416
State - User Correction.....	6.677, 4.62
State - WiMAX.....	6.391, 4.654



Time Shift (CA-Chips/40).....	4.731	Trigger Delay External - ARB.....	6.76, 4.223
Time Shift (ms) - GPS.....	6.251, 4.731	Trigger Delay External - CDMA2000.....	6.127, 4.563
Time Shift (P-Code Chips).....	6.250	Trigger Delay External - DM.....	6.202, 4.201
Time Slot Offset - BS - CDMA2000.....	6.168, 4.600	Trigger Delay External - GPS.....	6.231, 4.736
Timing Offset - BS - 3GPP FDD.....	6.538, 4.371	Trigger Delay External - GSM/EDGE.....	6.281, 4.286
Timing Offset - Multichannel BS - 3GPP FDD.....	4.412	Trigger Delay External - MCCW.....	6.308, 4.256
Timing Offset DL-UL DPCCCH - UE - 3GPP FDD.....		Trigger Delay External - TD-SCDMA.....	6.331, 4.764
.....	6.588, 4.444	Trigger Delay External - WiMAX.....	6.393, 4.712
To Destination - 3GPP FDD.....	6.489, 4.330	Trigger Delay External - WLAN.....	6.465, 4.646
To Destination - CDMA2000.....	6.116, 4.553	Trigger Delay Other Baseband - 3GPP FDD.....	6.499
Too many digits (-124).....	9.9	Trigger Delay Other Baseband - ARB.....	6.76, 4.223
Too much data (-223).....	9.10	Trigger Delay Other Baseband - CDMA2000.....	6.128, 4.563
Total Number of Users.....	4.784	Trigger Delay Other Baseband - DM.....	6.202, 4.201
Total Power - 3GPP FDD.....	6.494, 4.331	Trigger Delay Other Baseband - GPS.....	6.232, 4.736
Total Power - CDMA2000.....	6.121, 4.554	Trigger Delay Other Baseband - GSM/EDGE.....	6.281, 4.286
Total Power - GPS.....	6.226, 4.729	Trigger Delay Other Baseband - MCCW.....	6.308, 4.256
Total Power - TD-SCDMA.....	6.325, 4.754	Trigger Delay Other Baseband - TD-SCDMA.....	6.332, 4.764
TPC Data Source DPCCCH - BS - 3GPP FDD.....	6.521, 4.399	Trigger Delay Other Baseband - WiMAX.....	6.393, 4.712
TPC Data Source DPCCCH - UE - 3GPP FDD.....	6.589, 4.446	Trigger Delay Other Baseband - WLAN.....	6.466, 4.646
TPC Data Source F-PCCH - BS - 3GPP FDD.....	6.524	Trigger Inhibit External - 3GPP FDD.....	6.499
TPC Data Source PCPCH - UE - 3GPP FDD.....	6.611, 4.440	Trigger Inhibit External - ARB.....	6.76, 4.223
TPC For Output Power Control (Mis-) Use (F-DPCH) - BS - 3GPP FDD.....	4.405	Trigger Inhibit External - CDMA2000.....	6.128, 4.564
TPC Pattern - TD-SCDMA.....	6.366, 6.367, 4.789	Trigger Inhibit External - DM.....	6.202, 4.202
TPC Read Out Mode DPCCCH - BS - GPP3.....	6.523, 4.399	Trigger Inhibit External - GPS.....	6.231, 4.736
TPC Read Out Mode DPCCCH - UE - 3GPP FDD.....		Trigger Inhibit External - GSM/EDGE.....	6.281, 4.286
.....	6.591, 4.446	Trigger Inhibit External - MCCW.....	6.308, 4.256
TPC Read Out Mode F-DPCH - BS - GPP3.....	6.526, 4.404	Trigger Inhibit External - TD-SCDMA.....	6.332, 4.765
TPC Read Out Mode PCPCH - UE - 3GPP FDD.....		Trigger Inhibit External - WiMAX.....	6.393, 4.712
.....	6.612, 4.440	Trigger Inhibit External - WLAN.....	6.466
TPC Repeat Pattern - Test Case Wizard - 3GPP.....	6.658, 4.494	Trigger Inhibit External -3GPP FDD.....	4.341
TPC Repeat Pattern Data List- Test Case Wizard - 3GPP.....	6.659, 6.661	Trigger Inhibit External -WLAN.....	4.646
TPC Source - TD-SCDMA.....	6.366, 4.789	Trigger Inhibit Other Baseband - 3GPP FDD.....	6.500
TPC Start Pattern - Test Case Wizard - 3GPP.....	6.660, 4.493	Trigger Inhibit Other Baseband - ARB.....	6.78, 4.223
Traffic - MS - CDMA2000.....	6.181, 4.604	Trigger Inhibit Other Baseband - CDMA2000.....	6.128, 4.564
Training Sequence - GSM/EDGE.....	6.268, 4.299	Trigger Inhibit Other Baseband - DM.....	6.203, 4.202
Training Sequence Sync-Access Burst - GSM/EDGE.....		Trigger Inhibit Other Baseband - GPS.....	6.232, 4.736
.....	6.267, 4.301	Trigger Inhibit Other Baseband - GSM/EDGE.....	6.282, 4.286
Transition Time - WLAN.....	6.473, 4.635	Trigger Inhibit Other Baseband - MCCW.....	6.309, 4.256
Transmission direction - 3GPP FDD.....	6.493, 4.324	Trigger Inhibit Other Baseband - TD-SCDMA.....	6.332, 4.765
Transmission direction - CDMA2000.....	6.121, 4.549	Trigger Inhibit Other Baseband - WiMAX.....	6.394, 4.712
Transmission direction - TD-SCDMA.....	6.325, 4.751	Trigger Inhibit Other Baseband - WLAN.....	6.466
Transmission direction - WiMAX.....	6.386, 4.660	Trigger Inhibit Other Baseband -3GPP FDD.....	4.341
Transmission Time Interval - E-DPCCH - UE - 3GPP FDD.....	6.593, 4.449	Trigger Inhibit Other Baseband -WLAN.....	4.646
Transmission Time Interval - E-DPDCCH - UE - 3GPP FDD.....	6.602	Trigger Mode - 3GPP FDD.....	6.495, 4.338
Transmit Diversity - BS - 3GPP FDD.....	6.546, 4.355	Trigger Mode - ARB.....	6.74, 4.220
Transmit Diversity - BS - CDMA2000.....	6.171, 4.574	Trigger Mode - CDMA2000.....	6.124, 4.561
Transmit Diversity Mode - BS - CDMA2000.....	6.171, 4.574	Trigger Mode - DM.....	6.198, 4.199
Transport Block Size - BS1 - 3GPP FDD.....	6.564, 4.389	Trigger Mode - GPS.....	6.227, 4.733
Transport Block Size - TD-SCDMA.....	6.352, 6.359, 4.780	Trigger Mode - GSM/EDGE.....	6.277, 4.283
Transport Block Size - Test Case Wizard - 3GPP.....	6.666, 6.667, 4.530, 4.532	Trigger Mode - MCCW.....	6.306, 4.254
Transport Block Size - UE1 - 3GPP FDD.....	6.636, 4.476	Trigger Mode - TD-SCDMA.....	6.328, 4.762
Transport Blocks - TD-SCDMA.....	6.352, 6.359, 4.780	Trigger Mode - WiMAX.....	6.388, 4.710
Transport Blocks - UE1 - 3GPP FDD.....	6.636, 4.388	Trigger Mode - WLAN.....	6.460, 4.643
Transport Channel Enhanced DPCH - BS1 - 3GPP FDD.....	6.564, 4.387	Trigger Mode Armed_Auto - TD-SCDMA.....	4.762
Transport Channel State - TD-SCDMA.....	4.779	Trigger Mode Armed_Retrigger - TD-SCDMA.....	4.762
Transport Channel State - UE1 - 3GPP FDD.....	6.636	Trigger Mode Auto - TD-SCDMA.....	4.762
Transport Time Interval - BS1 - 3GPP FDD.....	6.565, 4.388	Trigger Mode Retrigger - TD-SCDMA.....	4.762
Transport Time Interval - TD-SCDMA.....	6.352, 6.359, 4.780	Trigger Mode Single - TD-SCDMA.....	4.762
Transport Time Interval - UE1 - 3GPP FDD.....	6.637, 4.476	Trigger parameters - 3GPP FDD.....	4.325
Trigger - Marker - CDMA2000.....	4.550	Trigger parameters - ARB.....	4.219
Trigger - Marker - TD-SCDMA.....	4.752	Trigger parameters - DM.....	4.198
Trigger - TD-SCDMA.....	4.752	Trigger parameters - GSM/EDGE.....	4.282
TRIGGER 1 - Input.....	1.10	Trigger parameters - MCCW.....	4.253
Trigger Configuration - Test Case Wizard - 3GPP.....	6.655, 4.486	Trigger Signal Duration - DM.....	4.200
Trigger Delay External - 3GPP FDD.....	6.499	Trigger signals.....	4.160
		Trigger Source - 3GPP FDD.....	6.505, 4.340
		Trigger Source - ARB.....	6.86, 4.222
		Trigger Source - CDMA2000.....	6.134, 4.563
		Trigger Source - DM.....	6.208, 4.200
		Trigger Source - GPS.....	6.239, 4.735
		Trigger Source - Graphics.....	4.32
		Trigger Source - GSM/EDGE.....	6.289, 4.285
		Trigger Source - Level Sweep.....	6.757, 4.86



Trigger Source - LF Sweep..... 6.755, 4.91  
 Trigger Source - List Mode..... 6.717, 4.71  
 Trigger Source - MCCW..... 6.314, 4.255  
 Trigger Source - RF Sweep..... 6.756, 4.80  
 Trigger Source - TD-SCDMA..... 6.337, 4.764  
 Trigger Source - WiMAX..... 6.399, 4.712  
 Trigger Source - WLAN..... 6.472, 4.645  
 Triggering sweep manually..... 6.737, 6.741, 4.88  
 TSC - GSM/EDGE..... 6.268, 4.299  
 Tuning input..... 1.9, 4.18  
 Turbo Coder - BS - CDMA2000..... 6.148, 4.594  
 Turbo Coder - BS1 - 3GPP FDD..... 6.562, 4.389  
 Turbo Coder - UE1 - 3GPP FDD..... 6.634, 4.476  
 Type - Power Sensors..... 6.38, 6.39, 4.58  
 Type (MAC) - WiMAX..... 6.415, 6.436, 4.680, 4.705

## U

UCorr..... 9.3  
 UEID - BS - 3GPP FDD..... 6.536, 4.377  
 UIUC - WiMAX..... 6.438  
 UIUC OFDMA - WiMAX..... 6.420, 4.698  
 UL-MAP Allocation Start Time - WiMAX..... 6.420, 6.439  
 UL-MAP Allocation Start Time Base - WiMAX..... 6.420, 6.438  
 UL-MAP File - WiMAX..... 4.677, 4.701  
 Ultra@VNC..... 1.33  
 Undefined header (-113)..... 9.10  
 Unframed - GSM/EDGE..... 6.273, 4.268  
 Uninterrupted level setting..... 6.31, 4.52  
 Unit - Power Sensors..... 6.35, 4.58  
 Units..... 3.14  
 Universal command..... 5.30  
 Unix controller..... 1.33  
 Unknown list type specified (242)..... 9.13  
 Up Range - Dyn Power Control BS1 - 3GPP FDD..... 6.558, 4.395  
 Up Range - Ext. Power Control UE1 - 3GPP FDD..... 6.630, 4.480  
 Uplink - 3GPP FDD..... 6.569, 4.324  
 Uplink - CDMA2000..... 6.172, 4.549  
 Uplink - TD-SCDMA..... 4.751  
 Uplink - WiMAX..... 6.386, 4.660  
 Upper case..... 6.1  
 UpPTS Power - TD-SCDMA..... 6.376, 4.792  
 UpPTS Power Step - TD-SCDMA..... 6.376, 4.792  
 UpPTS Repetition - TD-SCDMA..... 6.377, 4.792  
 UpPTS Start - TD-SCDMA..... 6.377, 4.792  
 USB (universal serial bus) interface..... 1.7  
 Use (DTX) - DPDCH UE - 3GPP FDD..... 4.463  
 Use all Subchannels..... 6.426, 4.689  
 Use Channels needed for Sync of Mobile (UE) - 3GPP FDD..... 6.509, 4.349  
 Use Compressed Mode - BS - 3GPP FDD..... 6.542, 4.355  
 Use Compressed Mode - UE - 3GPP FDD..... 6.581, 4.418  
 Use Dedicated Control (F-DCCH) - Predef - CDMA2000..... 6.140, 4.569  
 Use E-TFCl - E-DPCCH - UE - 3GPP FDD..... 6.593, 4.449  
 Use Fundamental (F-FCH) - Predef - CDMA2000..... 6.140, 4.569  
 Use Level Adjustment Data..... 6.13, 4.7  
 Use Paging Channel (F-PCH) - Predef - CDMA2000..... 6.138, 4.569  
 Use P-CCPCH - TD-SCDMA..... 6.341, 4.769  
 Use Pilot (F-Pich) - Predef - CDMA2000..... 6.138, 4.568  
 Use S-CCPCH - 3GPP FDD..... 4.349  
 Use S-CPICH as Phase Reference - BS - 3GPP FDD..... 6.545  
 Use Scrambling Code - TD-SCDMA..... 6.343, 4.771  
 Use Scrambling Code- BS - 3GPP FDD..... 6.545, 4.354  
 Use Subchannels x...y..... 6.426, 4.689  
 Use Sync (F-Sync) - Predef - CDMA2000..... 6.139, 4.569  
 Use TFCI DPCCH - BS - 3GPP FDD..... 6.520, 4.398  
 Use TFCI DPCCH - UE - 3GPP FDD..... 6.588, 4.445

User - TD-SCDMA..... 6.344, 4.772  
 User Clock - ARB..... 6.93, 4.231  
 User Coding - BS1 - 3GPP FDD..... 6.553, 4.386  
 User Coding - UE1 - 3GPP FDD..... 6.625, 4.473  
 User Correction..... 6.669, 4.61  
 User Correction Data..... 6.670, 4.63  
 User Data (DTX Pattern) - HSUPA FRC - 3GPP FDD..... 6.595, 4.468  
 User Equipment default values - 3GPP FDD..... 4.329  
 User ETSC - GSM/EDGE..... 4.300  
 User filter - 3GPP FDD..... 4.332  
 User Marker - AUX IO Configuration..... 4.15  
 User Period - 3GPP FDD..... 6.503, 4.343  
 User Period - CDMA2000..... 6.132, 4.565  
 User Period - TD-SCDMA..... 6.335  
 User Period Marker - TD-SCDMA..... 4.766  
 User Sync-Access Burst - GSM/EDGE..... 6.268, 4.301  
 User TSC - GSM/EDGE..... 6.267, 6.268, 4.300

## V

Value - User Correction..... 4.62  
 Variable FSK Deviation - DM..... 6.193, 4.182  
 Variation Active..... 4.46  
 Variation Step..... 6.686, 6.687, 6.730, 4.46, 4.53  
 Vector diagram..... 4.37  
 Vector modulation..... 6.691, 4.113  
 Version - 3GPP FDD..... 6.493, 4.324  
 Version - CDMA2000..... 6.135, 4.549  
 Version - TD-SCDMA..... 6.338, 4.751  
 Version - WiMax..... 6.401  
 Version - WiMAX..... 4.659  
 Virus-protection software..... 1.40  
 Visa Resource String - Ethernet..... 6.748, 4.19  
 Visual check of signal characteristics..... 4.30  
 VNC connection..... 1.33  
 Voltage - LF output..... 6.704, 4.95  
 Voltage - Test point..... 4.11  
 Voltage threshold..... 6.690, 4.14

## W

Walsh - MS - CDMA2000..... 6.180, 4.609  
 Walsh Code - BS - CDMA2000..... 6.161, 4.584  
 Walsh Code Column Index - BS - CDMA2000..... 6.169, 4.598  
 Walsh Code Offset - CDMA2000..... 6.114, 4.553  
 Walsh Length - BS - CDMA2000..... 6.161, 4.588  
 Wanted Signal / Interferer Level - Test Case Wizard - 3GPP..... 6.646, 4.510  
 Wanted Signal State - Test Case Wizard - 3GPP..... 6.667, 4.492, 4.504  
 Warnings..... 9.3, 3.9  
 Waveform File..... 6.90, 6.91, 4.211  
 Waveform File - TD-SCDMA..... 4.751  
 Waveform File - WiMAX..... 4.658  
 Waveform File - WLANA..... 4.624  
 Waveform Protected (261)..... 9.13  
 White space..... 5.18  
 Wideband setting - I/Q..... 6.694, 4.115  
 WiMax Version..... 6.401  
 Winbar..... 3.13  
 Window XP access..... 1.17  
 Windows button..... 3.15  
 Windows XP Firewall..... 1.25

## Z

Zero - Power Sensors..... 6.38, 4.59  
 Zone Index - WiMAX..... 4.686  
 Zone Number - WiMAX..... 4.686  
 Zone Segment - WiMAX..... 6.425, 4.686

Zone Type - WiMAX..... 4.686